

## Extensive forest leaf area survey aiming at detection of vegetation change in subarctic-boreal zone

Tomoko Kusakabe<sup>1\*</sup>, Hayato Tsuzuki<sup>1</sup>, Gary Hughes<sup>2</sup> and Tatsuo Sweda<sup>1</sup>

<sup>1</sup> College of Agriculture, Ehime University, 3-5-7 Tarumi, Matsuyama, Ehime 790-8566

<sup>2</sup> Department of Geology, University of Pennsylvania, 240 S. 33rd Street, Philadelphia, PA 19104-9316, U. S. A.

**Abstract:** The warming resulting from increasing anthropogenic carbon dioxide and other greenhouse gasses is expected to be most prominent in the subarctic-boreal region of the Northern Hemisphere. With the objective of setting up a baseline to monitor possible vegetation change in this region, a continuous vegetation profile extending 600 km from Edmonton, Alberta to Cluff Lake, Saskatchewan, Canada was measured using an airborne infrared laser altimeter mounted on a helicopter. Then the distribution of leaf area index over the same 600 km long transect was estimated from this vegetation profile based on a series of plot surveys on the ground to correlate the vegetation profile with leaf area index via standing stock. The distribution of leaf area index not only corresponded well with biome type, but also showed characteristic change in accordance with environmental gradient within a given biome, thus confirming that airborne laser altimetry is a powerful tool for measuring and monitoring such important vegetation characteristics as standing volume, leaf area index, *etc.* over an extensive area.

**key words:** leaf area index (LAI), airborne laser altimetry (ALA), vegetation profile, vegetation change, boreal forest

### Introduction

Climate warming due to increasing atmospheric carbon dioxide and other anthropogenic greenhouse gasses is expected to cause vegetation change (Emanuel *et al.*, 1985; Sweda *et al.*, 1995). This can take place anywhere on the globe, but is projected to be most conspicuous in higher latitudes of the Northern Hemisphere, where warming is considered most prominent (Houghton *et al.*, 1990). In view of the rise in observed and proxy-reconstructed temperature amounting to 1°C or more since the early 1800s (Jones, 1988; Sweda, 1996), the vegetation change may already be taking place. It may not yet be in such explicit forms as drastic shift in biome boundaries or definite change in species composition as is generally envisaged, but possibly be proceeding as a subtle and rather quantitative change in vegetation structure, which may well precede qualitative changes. Such minute changes are difficult to capture by ordinary vegetation survey conducted on a sample plot basis since other local environmental changes than climate warming may also affect vegetation structure and composition, and

---

\*E-mail address: kusa@agr.ehime-u.ac.jp

obscure the results from such a small-scale monitoring.

To overcome this difficulty in detecting subtle changes in vegetation, we have introduced airborne laser altimetry (ALA) to monitor the change in leaf area index (LAI) over a long distance. Being airborne, the advantage of the ALA exists in its coverage of long distance in a short time, thus providing an overview of an extensive transect while averaging and smoothing minor local variations (Sweda *et al.*, 1998). Of various quantitative measures of forest vegetation, the LAI was chosen in this study partly because it is one of the most important characteristics of forests along with the standing stock of forest biomass, and partly because it is also useful in global change studies as one of the vital boundary conditions to be input to general circulation models (GCMs) for predicting global warming (Trenberth, 1992).

As the study site for the present work, central northern Canada was chosen for a multitude of reasons. From the vegetation point of view, this part of Canada provides distinctive north-south zonation of biomes with a wide belt of boreal forest running in the center, and bounded by prairies to the south and by tundra to the north. As one of the major gateways to arctic Canada, this area also has an advantage from a logistics point of view. A well-developed highway system provides easy access to uninhabited wilderness, which is valuable especially for obtaining ground truth data.

### Materials and methods

The laser profiling transect in the present study extends north from Edmonton via Wandering River and Fort McMurray, Alberta to Cluff Lake, Saskatchewan, Canada, covering a total distance of nearly 600 km (Fig. 1). The southern quarter of this transect is an ecotone between the prairie to the south and the boreal forest to the north, and is classified as “the aspen grove section” of “the boreal forest region” by Rowe (1972). It is also called “the aspen parkland”, and is characterized by groves of trembling aspen (*Populus tremuloides*) scattered in open grassland. The boreal forest proper, covering the northern three quarters and beyond, is characterized by large patches of even-aged stands of jack pine (*Pinus banksiana*), white spruce (*Picea glauca*), black spruce (*Picea mariana*) and trembling aspen, all regenerated after fires. The transect had originally been intended to extended further north into tundra, but was cut short due to budget limitation.

The growing season in the study area as measured by number of summer months with mean temperature exceeding 5°C is longest at six months at Edmonton, the southern end of the transect, with the mean annual temperature of 3.6°C and annual precipitation of 463.1 mm (National Astronomical Observatory, 1998). Both temperature and precipitation decrease northward to 0.0°C and 445.8 mm at Fort McMurray with a reduced growing season of 5 months (National Climatic Data Center, NOAA: web site, <http://www.ncdc.noaa.gov/ghch/ghch.SELECT.html>). Further north at Fort Smith (60°01'N, 111°58'W), to compensate for Cluff Lake where no climatic record is available, the mean annual temperature plunges to -3.5°C with precipitation of 331.2 mm (Burns, 1973). Although the precipitation is heavily concentrated in the summer months, a moisture deficit may occur during the growing season.

Most of the grassland in the aspen parkland has now been turned into farmland, but

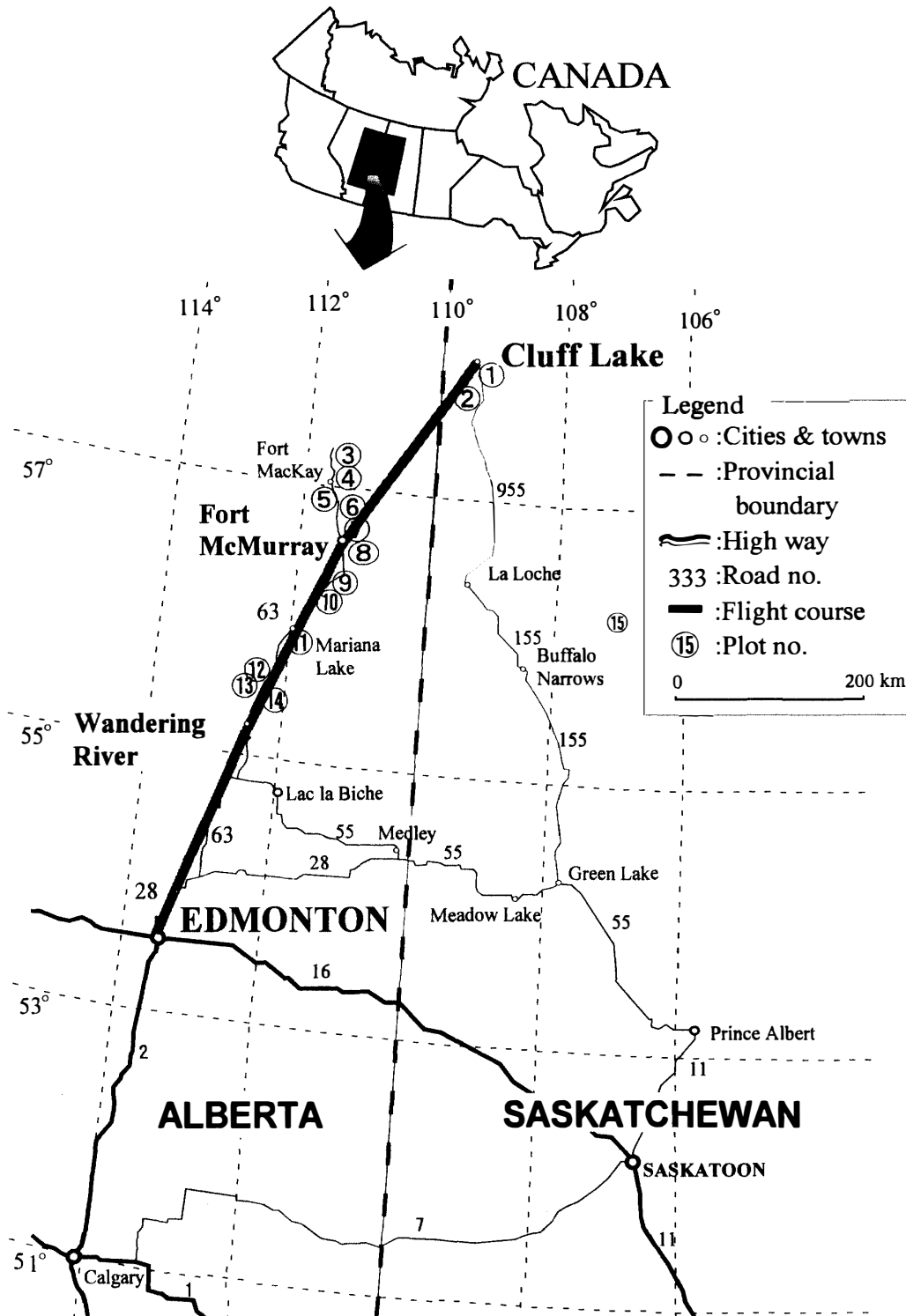

Fig. 1. Study site with airborne laser profiling course and sample plots.

most of the boreal forest in the region is still rather intact. The past industrial efforts in the region have been focused on mining, leaving forests relatively unscathed until a decade or so ago. Although recent technological innovation has made once disregarded trembling aspen superb material for pulp, and has given rise to its industrial exploitation. This is just starting, and most of the boreal forest is still intact (Sweda, 1995).

The airborne laser altimetry system employed in the present study consists of an infrared laser altimeter (ILA), a differential global positioning system (GPS) and a video tape recorder (VTR). The ILA emits laser pulses and measures the clearance between the aircraft and the object reflecting the laser beam from directly below, be it forest canopy or the ground. According to the catalogue specification, the ranging precision of the laser profiler is  $\pm 20$  cm. In comparison with the precision of  $\pm 5$  cm or so in direct measurement of height on felled trees, laser profiling is less accurate, but its precision of  $\pm 20$  cm is similar to that of trigonometric measurement of tree height on the ground with a Blume-Leiss hypsometer, or better. Thus, as far as tree height is concerned, we can expect a similar degree of precision as is obtained by conventional timber cruising on the ground.

The laser profiling was conducted at a frequency of 2000 Hz. With the aircraft (helicopter) flown at a mean ground speed of 140 km/hr in this mission, this frequency translates to a nominal horizontal measurement interval or spatial resolution of 2 cm along the flight track. However, to cope with the limitation in data storage, only one measurement in every 25 was recorded, resulting in an average measurement interval or spatial resolution of 50 cm along the flight track. Again, according to the catalogue specification, the precision of the GPS horizontal positioning is  $\pm 20$  cm within a 10 km range of the ground control station. On the actual mission, the ground control was more sparse at an interval of approximately 200 km, and thus the positioning precision should be worse than the catalogue value but is expected to be a couple of meters or so.

By subtracting the laser-measured clearance from the GPS-monitored navigation altitude of the aircraft, a surface profile was obtained, which consists partly of vegetation canopy and partly of topographic surface. A continuous topographic profile was obtained, first by picking up patchy reflections from the ground alone, and then interpolating them into a smooth curve using spline fitting. Finally the vegetation profile was generated by subtracting the topographic profile from the original surface profile, and shown in Fig. 9a for the entire 600 km transect.

To correlate this vegetation profile with actual standing stock and LAI, a series of ground surveys was conducted along the flight track. A total of 14 sample plots, each representing either one or two of young, mid-aged and mature stands of jack pine, white spruce, black spruce and trembling aspen, were located along the flight track. The plots were square with side length approximately equal to the mean tree height so that the plot area would be roughly proportional to the standing stock and leaf area of the plot.

Standing stock of stem volume within the plot was obtained from the stem diameter at breast height (dbh) using the correlation between the stem volume and dbh of individual trees. Thus, in the plot survey dbh was censused, while the volume equation was constructed for each species from the aggregate of sample trees consisting of four samples, *i.e.* one large, two mid-sized and one small stems from each plot surveyed.

Then, the individual stem volume was summed up for the standing stock of each plot. In this process, the stem volume of the sample trees was evaluated by dissecting each trunk into 7 to 23 logs depending upon the tree size, and log volume was evaluated according to the Smalian formula except for the apex where the conic formula was used (Tsuzuki *et al.*, 1998).

The plot leaf area was obtained on the basis of direct measurement of the same sample trees felled for volume measurement. As shown in Fig. 2, the leaf area was obtained using its regression upon leaf weight. In small sample trees, all the leaves were detached from the twig, and weighed. In large sample trees, it was estimated by branch using correlation between the leaf weight and base area of sample branches, and then summed up for the entire tree. Leaf area itself was measured first by scanning the leaves with a scanner as graphic images, and then by analyzing their area on a Power Macintosh 9600/233 using a public domain program "NIH Image" from the U.S. National Institute of Health. As will be naturally envisaged from this method of measurement, the leaf area in this paper is one-sided area for broadleaved trees, and projected area for conifers. Once the leaf areas for individual sample trees were thus obtained, the correlation was established with dbh to estimate leaf area for every tree in the plot, which sums up to the plot leaf area. The LAI was then obtained as the ratio of the total leaf area in the plot to the plot area itself.

Apart from this direct measurement, LAI was also estimated with two other methods for comparison. One is with the Plant Canopy Analyzer from LI-COR, which converts the light intensity on the forest floor relative to that in an open area nearby into

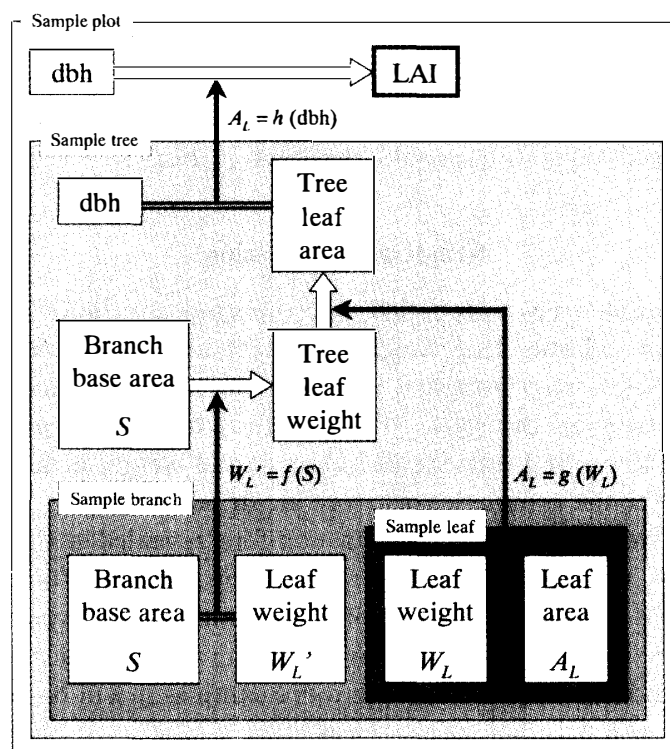

Fig. 2. Flow leading to estimates of sample plot LAI.

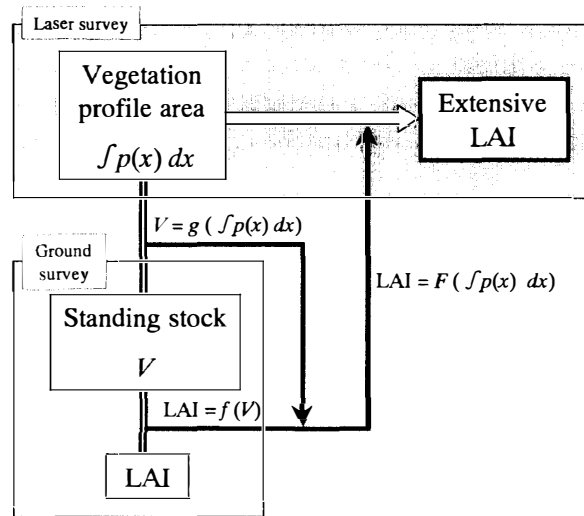

Fig. 3. Flow leading to LAI estimate over entire flight course.

LAI. Another uses a hemispherical photograph of the canopy taken upward from the forest floor with a fisheye lens, from which LAI was calculated according to the gap fraction method developed by Hashimoto (1997) based on the Markovian theory of leaf shading by another. Both methods are much less time-consuming than the direct measurement, and thus should be useful to cover more control points on the ground once their bias and correction are established.

These LAI measurements were related with the laser-based vegetation profile through standing stock to estimate the distribution of LAI all along the entire length of the 600 km transect. The procedure to find functional relationships of standing stock with vegetation profile area and LAI, and to combine them for a LAI estimator as a function of laser-based vegetation profile, is shown in Fig. 3.

### Result and discussion

A total of 50 sample trees were felled, and their mensurational characteristics such as dbh, height, stem volume, leaf weight and leaf area are given in Table 1. For broadleaved trees, leaves were weighed green out in the field since they can be easily detached from the twig on the spot. For conifers, however, leaf detachment needs meticulous fingertip work, and thus the detachment and weight measurement were done in the laboratory after the sample leaves were air-dried.

Air-dried leaf weight and leaf area in conifers revealed a linear relationship as shown in Fig. 4. A similar straight-line relationship was also found for broadleaved trees. In the present analysis, a distinction was made only between broadleaved trees and conifers, with the former represented by trembling aspen alone and the latter by jack pine, white spruce and black spruce. With more samples it will be possible to establish the relationship on an individual species basis.

Figure 5 shows a straight-line relationship between branch base area and leaf weight in conifers on a log-log scale, which translates to a power function as given in the

Table 1. Characteristics of sample tree.

Tree ID	Species	dbh (cm)	Height (m)	Volume (m <sup>3</sup> )	Leaf weight*		Leaf area (m <sup>2</sup> )	Remarks	
					Dry (kg)	Green (kg)		Plot no.	Canopy layer
1		16.9	15.90	0.187		4.45	18.79		
2		11.3	14.30	0.072		1.88	7.92	3	upper
3		9.0	12.12	0.042		1.33	5.62		
4		6.8	11.30	0.020		0.69	2.91		
5		19.0	24.00	0.339		4.23	17.84		
6		15.7	22.15	0.226		2.90	12.26	7	
7		12.4	20.90	0.137		1.75	7.37		
8		6.0	9.80	0.015		0.19	0.78		
9	<i>Populus tremuloides</i>	37.2	28.10	1.530		18.86	79.66		
10		29.0	29.05	0.913		7.80	32.96	9	upper
11		23.5	29.00	0.573		3.35	14.15		
12		17.3	25.00	0.313		1.83	7.71		
13		9.1	9.73	0.026		1.05	4.43		
14		4.0	7.23	0.006		0.42	1.77	9	lower
15		2.7	5.23	0.002		0.21	0.89		
16		5.2	6.59	0.009		0.76	3.21		
17		3.3	5.27	0.003		0.22	0.91	13	
18		1.2	2.59	0.0004		0.13	0.54		
19		2.1	4.75	0.001		0.05	0.23		
20		10.8	10.10	0.052	2.46		10.41		
21		6.5	6.90	0.014	0.53		2.24	1	
22		7.8	7.30	0.019	0.67		2.84		
23		3.7	4.72	0.004	0.06		0.27		
24		21.3	10.55	0.209	8.32		35.17	2	
25		13.1	10.00	0.074	2.09		8.83		
26	<i>Pinus banksiana</i>	18.7	14.55	0.181	6.35		26.84		
27		14.0	13.10	0.108	3.13		13.22	4	
28		16.5	13.00	0.133	3.55		15.00		
29		9.0	10.75	0.038	0.26		1.11		
30		3.0	3.66	0.002	0.19		0.82		
31		2.5	3.22	0.001	0.17		0.71	12	
32		1.7	2.85	0.001	0.09		0.39		
33		1.3	2.53	0.0004	0.04		0.16		
34		13.1	11.89	0.088	6.37		19.20		
35		10.4	10.21	0.047	3.34		10.07	5	
36		3.5	4.44	0.003	0.56		1.69		
37		0.8	1.62	0.0003	0.14		0.43		
38	<i>Picea mariana</i>	4.6	4.00	0.005	1.87		5.64		
39		2.4	2.78	0.002	0.67		2.01		
40		-	1.25	0.0002	0.19		0.58	8	
41		-	0.60	0.00003	0.06		0.18		
42		-	0.30	0.000005	0.01		0.03		
43		17.7	14.35	0.182	13.08		45.02		
44		8.9	9.47	0.032	1.57		5.41	3	lower
45		5.4	5.18	0.009	0.78		2.70		
46	<i>Picea glauca</i>	1.7	2.33	0.001	0.20		0.67		
47		37.5	26.60	1.399	39.39		135.63		
48		27.5	23.74	0.626	13.70		47.19	10	
49		22.0	23.26	0.422	8.88		30.58		
50		10.7	10.84	0.056	0.74		2.56		

\*Broadleaf (*Populus*) was measured green out in the field, while conifers (*Pinus* & *Picea*) were air-dried and measured back in laboratory.

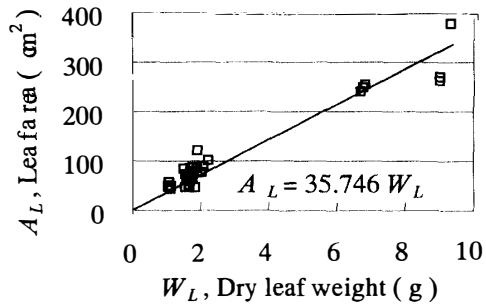

Fig. 4. Relationship between dry leaf weight and leaf area in conifers.

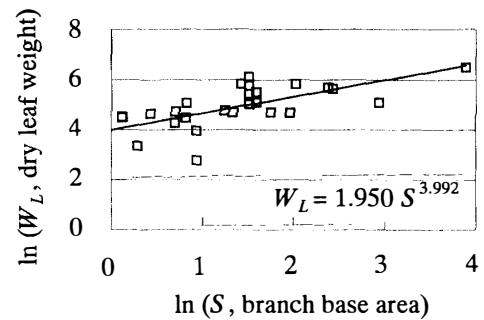

Fig. 5. Relationship between branch base area and dry leaf weight in conifers.

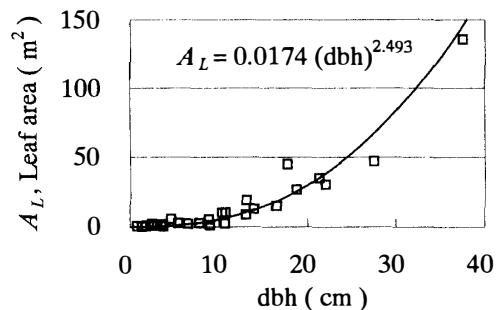

Fig. 6. Relationship between dbh and leaf area in conifers.

same figure. The relationship was judged to be reasonably linear, making it useful to estimate leaf weight from cross section of the branches at their base.

Figure 6 shows the power relationship between the leaf area and dbh in individual trees, according to which individual leaf area for every tree in the plot was estimated. A mechanical analogy of tree leaves as an evaporator and stem as a pipe to pass water to the foliage, requires that the cross section of the pipe, *i.e.* the basal area  $S$  of the stem, be proportional to the total leaf area  $A_L$  of the tree. This in turn requires that  $(\text{dbh})^2$  be proportional to the leaf area since the basal area is related to dbh by  $S = \pi(\text{dbh})^2/4$ . This suggests that the power in the leaf area equation in Fig. 6 theoretically be 2 rather than 2.493 as obtained through least squares fitting of the equation. As a matter of fact, two outliers in Fig. 6 *i.e.* the largest and the third largest in leaf area seem to be bringing the curve up to the effect of making the power of the best-fit curve greater than theoretically expected. There is a good possibility that the power may tend to 2 as more sample trees are incorporated. In the present paper, however, the parameters were used as they had been determined through the least squares fitting and are given in Fig. 6. Though omitted here, a similar well-defined relationship was found in the broadleaved trees.

The results from the plot survey on the ground are summarized in Table 2. There are 14 plots involved altogether. The standard method of plot survey for standing stock and LAI explained in the Materials and Methods Section was employed in 11 of them. In the rest, *i.e.* in plots 6, 11 and 14, however, a more expedient method of Bitterlich sampling was employed. In this method, the standing stock is obtained as a product of mean tree height and basal area (sum of stem cross sections at breast height)



with the latter directly measured with a Spiegel Relaskop rather than measuring individual trees and summing them up (Philip, 1994). As a matter of fact, the Bitterlich estimates were made simultaneously with the standard plot survey in the majority of the plots to correlate them and correct the former. As naturally envisaged from the nature of direct measurement of basal area in this method, neither dbh nor stem density is available as indicated in Table 2.

By appearance the boreal forest seems to be a mosaic of single-species, even-aged stands. But frequently under the canopy of what seem to be aspen stands, another canopy mainly consisting of white spruce exists. In such cases, the two different canopy layers were distinguished, and accordingly the stand characteristics are given separately in Table 2. Three different estimates of LAI obtained by the direct measurement, Plant Canopy Analyzer and gap fraction methods are also given.

The last column in Table 2 is the area under the vegetation profile obtained by airborne laser altimetry. As shown in Fig. 7, this vegetation profile area is well correlated with standing stock, and the latter should theoretically be expressed as a function of the former raised to the power of 1.5 as reasoned below. The standing stock can be expressed as a product of the mean individual stem volume and stem density, in which the former can be represented by the stand height. On the other hand, from the laser profiling point of view, the vegetation profile area is also proportional to tree height and stem density. Taller trees bring the profile high and the higher stem density keeps it level and high, resulting in a larger vegetation profile area. Since

Table 2. Stand characteristics of sample plots.

Plot no.	Species * <sup>1</sup>	Canopy layer	Stand age	Survey method * <sup>2</sup>		Mean dbh (cm)	Stem density (trees/ha)	Mean tree height (m)	Basal area (m <sup>2</sup> /ha)	Standing stock (m <sup>3</sup> /ha)		LAI* <sup>3</sup>			Vegetation profile area (m <sup>2</sup> /100m)	
				Plot	Bit					By layer	Plot	D.M.				
												By layer	Plot	Plot		C.A.
1	Pb		47	○	○	6.3	2244	8.5	7.88	37.2		0.54	1.07	2.15	888.6	
2	Pb		106	○	○	12.5	936	9.6	12.35	72.2		1.02	0.87	2.25	983.5	
3	Pt	upper	36	○	○	10.3	1844	14.2	16.19	127.0		0.87	1.69	2.51	1309.3	
	Pg	lower	39	○	○	6.9	1721	5.5	8.00	51.5		0.82	1.69	2.51	1309.3	
4	Pb		55	○	○	13.2	1161	14.3	17.62	106.9		1.49	1.46	2.75	1408.2	
5	Pm		64	○	○	4.5	8843	8.2	21.01	125.3		3.05	2.09	3.28	818.5	
6	Pg		110	-	○	-	-	26.6	45.56	556.5	6.22	* <sup>4</sup> 6.22	* <sup>4</sup> 3.30	3.90	2640.7	
7	Pt		40	○	○	11.6	3140	21.7	37.55	343.5		1.88	3.05	1.84	2157.0	
8	Pm		30	○	○	-	22752	1.5	1.75	5.2		0.83	0.66	1.51	131.4	
9	Pt	upper	78	○	○	24.5	1066	25.2	51.43	606.5		3.12	3.27	2.36	2569.8	
	Pt	lower	-	○	○	2.9	3751	-	3.22	15.8		0.15	3.27	2.36	3.00	2569.8
10	Pg		70	○	○	21.0	1053	24.2	43.34	446.5		5.14	2.93	3.72	2215.5	
11	Pm		161	-	○	-	-	14.0	41.31	293.6	3.85	* <sup>4</sup> 3.85	* <sup>4</sup> 2.71	4.12	1418.8	
12	Pb		12	○	-	2.0	53191	-	18.87	58.4		0.93	1.73	2.88	269.4	
13	Pt		15	○	-	2.1	32663	-	12.96	52.7		0.58	2.03	2.82	430.1	
14	Pt	upper	-	-	○	-	-	23.0	36.00	416.1		2.28	* <sup>4</sup>	* <sup>4</sup> 2.68	3.34	2273.7
	Pg	lower	53	-	○	-	-	9.9	1.33	7.8	423.9	0.25	* <sup>4</sup> 2.53	* <sup>4</sup> 2.68	3.34	2273.7

\*<sup>1</sup> Pb: *Pinus banksian*  
 Pt: *Populus tremuloides*  
 Pg: *Picea glauca*  
 Pm: *Picea mariana*

\*<sup>2</sup> Plot: Sample plot  
 Bit: Bitterlich

\*<sup>3</sup> D.M.: Direct measurement  
 C.A.: Plant canopy analyzer  
 G.F.: Gap fraction model

\*<sup>4</sup> Estimated from LAI-standing stock relationship in sample plots

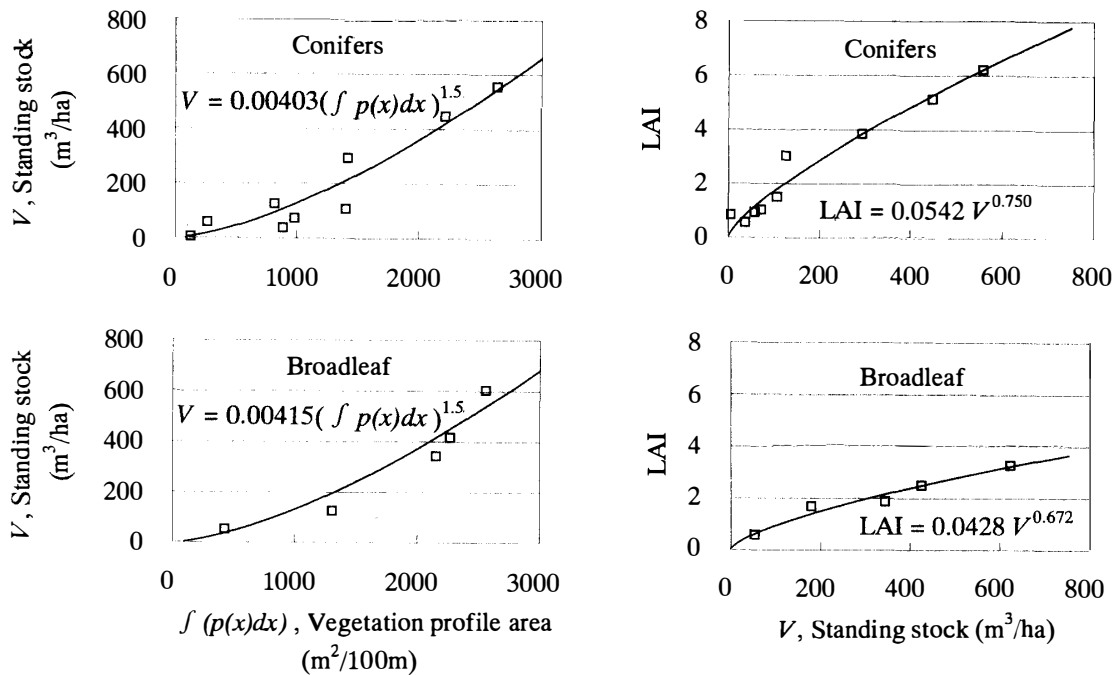

Fig. 7. Relationship between vegetation profile area and standing stock.

Fig. 8. Relationship between standing stock and LAI.

the volume of the standing stock has the dimension of length cubed while the profile area is length squared, the former has to be a function of the latter raised to the power of 3/2. In the figure, the standing stock is given on a per-hectare basis, and the vegetation profile area on per 100 m of flight passage.

Figure 8 shows the relationship between standing stock and LAI separately for conifers and broadleaved trees. In both cases, the graphs show that the foliage increases with standing volume of the stem. Conifers have nearly twice as much LAI as do broadleaved trees for a given value of standing stock. While the amount of foliage a stand can hold should have a certain limit due to self-shading, stem wood can be accumulated more or less indefinitely as long as trees are alive, with the former approaching an asymptote as the latter increase as seen in Fig. 8, where the relationship is expressed by a power function of experimental nature.

It has been explained that the vegetation profile area can be related to LAI either directly or indirectly via standing stock. The present analysis revealed a better correlation by the latter method, so the distribution of the LAI along the entire course of the laser profiling flight was estimated using the indirect relationship between vegetation profile area and LAI via the standing stock. The result is given in Fig. 9b along with the original vegetation profile in Fig. 9a.

To show the validity of the above results, the estimated LAI was plotted against the actually measured LAI for all the sample plots, as shown in Fig. 10. The solid diagonal represents a regression line which is constrained to pass through the origin, while the broken one is the best-fit regression without any constraints. Against the theoretical expectation of unity, the slope of the regression line is slightly less in both cases. This

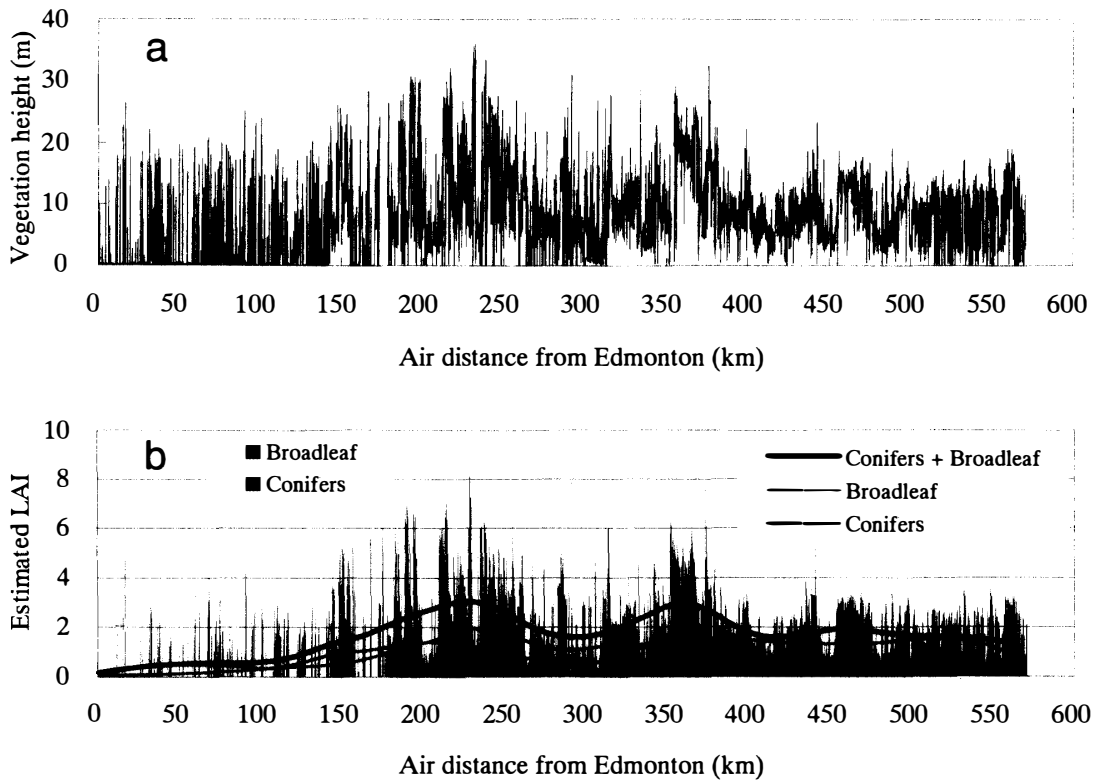

Fig. 9. a. Vegetation profile of the entire flight course.  
 b. Estimated LAI over the entire flight course.

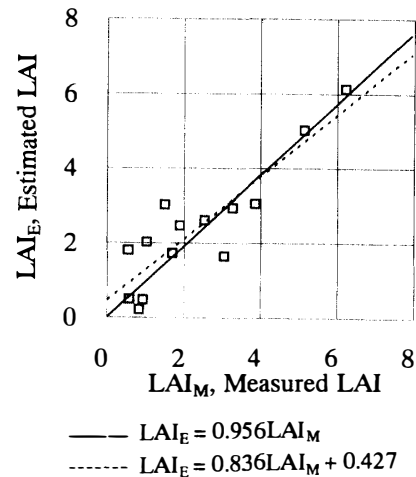

Fig. 10. Comparison between measured and estimated LAI.

signifies that the solid line underestimates the actual LAI, while the broken line tends to overestimate the LAI toward the lower end, and underestimate it toward the higher end. In the present analysis, it is not clear whether this is due to some inherent deficiency in the methodology or simply due to random variation resulting from chance choice of the sample plots.

Figure 9b gives us considerable information about the nature of the boreal forest as

well as the possibility of the laser profiling technique. In this figure, LAI estimates are given in two different ways for both conifers and broadleaved trees. In view of the vast amount of vegetation profile data, the original estimate of LAI was made for every 5 m along the transect, and then a mean for 20 consecutive estimates representing every 100 m interval was calculated, and shown as vertical bars in Fig. 9b. To obtain the more general trend over the entire transect, these 100-m means were further averaged for every 10 km interval, to which a spline curve of stiffness ( $\lambda$ ) = 10000 was fitted, and shown as the smooth curves.

While the relative abundance of broadleaf leaf area decreases, that of conifers increases northward, with the latter surpassing the former at somewhere around 140 km north of Edmonton. This point corresponds to the boundary between aspen parkland and boreal forest, where the total LAI also changes significantly. In aspen parkland LAI is relatively low since trembling aspen groves are intermixed with grassland, while in boreal forest LAI is relatively high since continuous forest canopy dominates there. Figure 9b also shows a continued northward decrease in the proportion of aspen LAI into the boreal forest. This result corresponds well with the description by Rowe (1972) that the proportion of spruce increases northward at the expense of aspen. Within the boreal forest zone, the relative abundance of forest in a given area changes with local vegetation and past fire history, resulting in ups and downs in LAI. Where wetlands dominate the landscape or the stands regenerating after fire are relatively young, LAI is relatively low, as seen in Fig. 9b.

Figure 9 also shows that the production center of boreal forest lies rather south toward the boundary with aspen parkland at around 250 km from Edmonton. In other words, LAI decreases both toward the north and south from this point. Although not given in this paper, a similar trend was observed in latitudinal distribution of standing stock. Most probably the northward decrease is due to decreasing temperature, and the southward decrease to increasing aridity.

In spite of the versatility of the airborne laser profiling demonstrated above as a powerful tool to overview prevailing trends over an extensive transect, there still remain some problems to be solved for more reliable estimates of LAI. In Fig. 11 the LAIs indirectly measured with the Plant Canopy Analyzer and gap fraction model are plotted against the directly measured counterpart. As obviously seen, the former does not increase in proportion to the latter against the logical expectation of linearity. This signifies that the indirect measurements underestimate the reality toward the higher values of LAI, and consequently the laborious and time-consuming direct measurements cannot easily be replaced by indirect methods of measurement.

Another difficulty is the high variability in LAI even in direct measurement, which in turn affects the LAI estimate from the vegetation profile. In Fig. 12, LAI measurements from five different coniferous stands of boreal Canada (Cannell, 1982) are plotted against standing stock along with our own direct and indirect measurements. It has already been pointed out that our indirect measurements underestimate LAI, but the dotted regression curve based on the data from Cannell is also considerably different from that on our own direct measurement. The LAI estimate to be deduced from the vegetation profile differs greatly depending upon the regression curve used. It is not yet clear if this difference is inherent to the nature of the leaf area or due more to technical

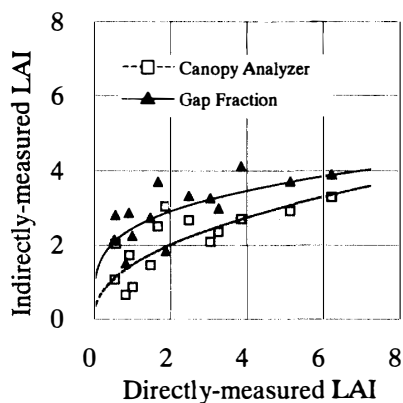

Fig. 11. Comparison among three different measurements of LAI.

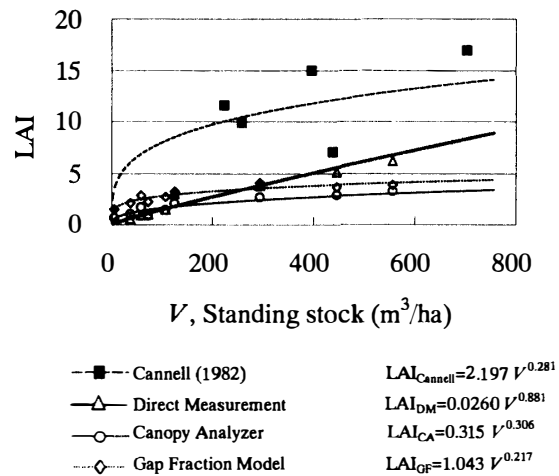

Fig. 12. Comparison among four different relationship between LAI and standing stock in conifers.

instability/inconsistency of measurement. This point has to be made clear for more reliable and realistic estimates of LAI over the extensive transect.

In spite of these difficulties, there is no doubt that airborne laser profiling is a powerful method to measure forest stand characteristics over an extensive area in a short period of time. Mention should also be made of the possibility of estimating LAI from the vegetation profile by other methods than those used in this paper. One is Fourier analysis; the other is mean free path analysis. The power spectrum of the vegetation profile obtained by the former should be related to LAI in one way or another, and the mean free path defined as the mean distance a laser beam can travel into the canopy without being intercepted by foliage should be directly proportional to the size and density of the leaves in the canopy, and thus to LAI. Incorporation of these new methodologies should improve the accuracy and reliability of the LAI estimation with the laser profiling.

#### References

- Burns, B.M. (1973): *The Climate of the Mackenzie Valley-Beaufort Sea*, Vol. 1. Toronto, Environment Canada, xvii + 225 p.
- Cannell, M.G.R. (1982): *World Forest Biomass and Primary Production Data*. London, Academic Press, viii + 391 p.
- Emanuel, W.R., Shugart, H.H. and Stevenson, M.P. (1985): Climatic change and the broad-scale distribution of terrestrial ecosystem complexes. *Clim. Change*, 7, 29–43.
- Hashimoto, T. (1997): *Study on Estimation of Radiative Fluxes and Snowmelt Rates in Forests with Canopy Structures*. Ph. D. Thesis, Iwate University, 104 p (in Japanese).
- Houghton, J.T., Jenkins, G.J. and Ephraums, J.J. (1990): *Climate Change, The IPCC Scientific Assessment*. Cambridge, Cambridge University Press, xxxix + 365 p.
- Jones, P.D. (1988): Hemispheric surface air temperature variations, Recent trends and update to 1987. *J. Clim.* 1, 654–660.
- National Astronomical Observatory. (1998): *Chronological Scientific Tables 1999*. Tokyo, Maruzen, 20 + 1050 p (in Japanese).

- Philip, M.S. (1994): *Measuring Trees and Forests*. Wallingford, Cab International Press, xiv + 310 p.
- Rowe, J.S. (1972): *Forest Regions of Canada*. Ottawa, Canadian Forestry Service, x + 168 p.
- Sweda, T. (1995): Forests and forestry of Canada. *Shinrin Kagaku*, **13**, 14–21 (in Japanese).
- Sweda, T. (1996): Variability in terrestrial ecosystems. *Global Warming as seen from the Viewpoint of Atmospheric-Hydrospheric Science*, ed. by N. Handa. Nagoya, Nagoya University Press, 250–270 (in Japanese).
- Sweda, T., Kodaira, T. and Kitoh, A. (1995): Global vegetation response to climate change in doubling atmospheric carbon dioxide. *Greenhouse Gasses and Agroforest Ecosystems (1995 Environmental Climatology Symposium)*, 47–54.
- Sweda, T., Yamamoto, T. and Shibayama, Z. (1998): Airborne infrared-laser altimetry of forest canopy profile for extensive and accurate assessment of timber resource and environmental function of forests. *Proc. of IUFRO International Symposium on Global Concerns for Forest Resource Utilization (FORESEA)*, 736–745.
- Trenberth, K.E. (1992): *Climate System Modeling*. Cambridge, Cambridge University Press, xxix + 788 p.
- Tsuzuki, H., Abraham, E.R.G., Kusakabe, T., Yamamoto, T. and Sweda, T. (1998): Timber cruising over extensive forest area with airborne laser altimeter. *Proc. of IUFRO International Symposium on Global Concerns for Forest Resource Utilization (FORESEA)*, 746–754.

*(Received April 12, 1999; Revised manuscript accepted July 2, 1999)*