

UPPER ATMOSPHERE PHYSICS DATA OBTAINED AT SYOWA STATION IN 2000

Yasuo KATO¹, Nobuaki SHIGENO², Mitsuteru SATO³,
Tsukasa KITAHARA⁴, Atsushi ABE⁵,
Masayuki KIKUCHI⁶, Akira KADOKURA⁶ and Makoto TAGUCHI⁶

¹*Solar-Terrestrial Environment Laboratory, Nagoya University, Toyokawa 442-8507*

²*Kakioka Magnetic Observatory, Niihari-gun Yasato-machi, Ibaraki 315-0116*

³*Tohoku University, Sendai 980-8578*

⁴*Shinshu University, Nagano 380-8553*

⁵*Communications Research Laboratory, Koganei-shi, Tokyo 184-8795*

⁶*National Institute of Polar Research, Itabashi-ku, Tokyo 173-8515*

1. Introduction

This data book summarizes upper atmosphere physics data acquired by the 41st Japanese Antarctic Research Expedition (JARE-41) with the "Upper Atmosphere Physics Monitoring (UAPM) System" at Syowa Station in 2000. Observation items are as follows:

- 1) Geomagnetism :
 - H-, D- and Z-components of magnetic variations
 - Total force of the geomagnetic field
 - H-, D- and Z-components of magnetic pulsations
- 2) ELF-VLF wave :
 - Intensities at 0.35, 0.75, 1.2, 2, 4, 8, 30, 60 and 95 kHz
 - Wide-band (0-10 kHz) signal of ELF-VLF emissions
- 3) Ionosphere :
 - Cosmic noise absorption at 30 MHz observed with a broad-beam riometer
- 4) Aurora :
 - All-sky imagers :
 - CCD type : Panchromatic images recorded in a digital format
 - Video type : Panchromatic video signal recorded by analog tapes
 - Scanning photometers :
 - Meridian-scanning record at the following seven wavelengths
 - 427.8 nm (N₂⁺1NG), 486.1 nm (H β), 487.4 nm (BG of H β),
 - 557.7 nm (OI), 630.0 nm (OI), 777.4 nm (OI), and 844.6 nm (OI)

An outline of the observation system is given in Section 2. Section 3 describes specifications of the observation instruments and the data acquisition systems. Observation periods are also listed

in Section 3. Format of the compiled digital data is shown in Section 4. Summary plots in the period of January 1-December 31, 2000 are given in the Appendix.

All-sky imager observation data, magnetograms and summary plots of the monitoring data are available to users on request. The request should be addressed to:

World Data Center for Aurora
National Institute of Polar Research
9-10, Kaga 1-chome, Itabashi-ku,
Tokyo 173-8515, Japan.
E-mail: aurora@nipr.ac.jp

Digital and analog data described here are available to researchers who will do collaborative studies with the upper atmosphere physics group of NIPR. The request should be addressed to:

Upper Atmosphere Physics Research Division
National Institute of Polar Research
9-10, Kaga 1-chome, Itabashi-ku,
Tokyo 173-8515, Japan.

2. Upper Atmosphere Physics Monitoring (UAPM) System

A real-time digital data acquisition system for the upper atmosphere physics observation was constructed at Syowa Station in January 1981 (Sato *et al.*, 1984). Data obtained from the system have been collected and published annually in the JARE Data Reports (Upper Atmosphere Physics) (Sato *et al.*, 1984, 1991; Fujii *et al.*, 1985, 1994; Sakurai *et al.*, 1985; Ono *et al.*, 1986, 1993; Yamagishi *et al.*, 1987; Kikuchi *et al.*, 1988; Miyaoka *et al.*, 1990; Kadokura *et al.*, 1992; Yamazaki *et al.*, 1995; Tonegawa *et al.*, 1996; Obara *et al.*, 1996; Arisawa *et al.*, 1997; Kawana *et al.*, 1998; Takeuchi *et al.*, 1999; Okano *et al.*, 2000; Maegawa *et al.*, 2000). This report is the 20th of this series.

A block diagram of the system, including other ground observations, is shown in Fig. 1. The sensors for measuring weak natural electromagnetic waves such as ELF-VLF emissions, the three components of ULF magnetic pulsations and cosmic radio noise absorption (CNA) have been placed at a remote station on West Ongul Island, located about 5 km from Syowa Station in order to avoid man-made electromagnetic interference. Data of the magnetic pulsations and CNA are transmitted continuously to Syowa Station by a PCM telemeter in VHF band. Wide-band signals of ELF-VLF emissions are transmitted to Syowa Station through an FM telemeter in UHF band.

At the remote station, the electric power which drives all the instruments has been supplied by a solar battery system with maximum output power of 530 W since February 1985. An additional

solar battery system with maximum power of 365 W was installed in January 1987 to reinforce the original battery system. The solar battery system consists of eighteen rechargeable car batteries (200 Ah each), five solar panels and three controllers in total. During winter when no sunlight is available, these batteries are charged manually about once a month by using a 10 kVA diesel-engine dynamo, which was installed in 1992 in place of the previous 16 kVA one.

The fluxgate and proton magnetometer sensors are placed at Syowa Station on East Ongul Island, about 150 m apart from the Data Processing Building. Scanning photometer is placed on the roof of the building, and all sky imagers are in an optical observation room in the building. Data acquisition facilities for the auroral observations are installed inside the building. All the outputs obtained from the observation instruments except the auroral photometric ones are transferred to the matrix terminal board and then recorded with pen recorders, analog data recorders and a computer system. These data had been recorded simultaneously with two sets of the TEAC DR-200 digital data logger systems since January 1987 and with the Accurate Timing data Logging and Analysis support System (ATLAS) since February 1997. Recording by the TEAC systems was terminated in January 1999, and ATLAS succeeded them since then. An 8 mm video tape recorder is used to record wide-band VLF emissions, and 24-hour data can be stored on one volume of 8 mm video tape.

Universal time (UT) is supplied from a precise time-keeping system. This system consists of a GPS satellite timing receiver, a quartz frequency standard with a stability of 2×10^{-11} /day, and time code generators. The time code generators supply the IRIG-A, -B and slow codes for analog data recorders and the 36-bit BCD code for the digital recording systems, respectively. The absolute accuracy of this system is estimated to be about 1 ms.

3. Specifications of Instruments

3.1. Geomagnetism

(1) *Magnetogram*

Magnetic variations were measured by a three-axis fluxgate magnetometer. Full scale ranges were +1250 to -3750 nT for H-component and ± 2500 nT for D- and Z- components, respectively, with the frequency response of DC–2 Hz and noise levels less than 0.5 nT. The magnetometer data were recorded in digital form at the sampling rate of 1 Hz. The H-component data were also recorded on a chart recorder.

(2) *ULF magnetic pulsations*

The H-, D-, and Z-components of ULF magnetic pulsations are detected by three sets of search coil magnetometers. The search coil sensors have copper wires (0.4 mm ϕ , 40000 turns each) wound around Permalloy cores (1 cm in diameter \times 100 cm in length). Measurable intensity range of the magnetometer is 0.001–5 nT/s and the frequency response is 0.001–3 Hz. The search coil

magnetometers are installed at the remote station on West Ongul Island. The output signals transmitted by the PCM telemeter are recorded on a chart recorder and a digital data recorder. The sampling frequency of the digital data is 10 Hz for each component.

(3) *Absolute observation of geomagnetic field*

Absolute values of the magnetic field were observed, basically, once per month during a magnetically quiet day. At that time, total force observation was carried out using a portable proton magnetometer. Based on those observations, baseline values for the fluxgate magnetometer were calculated. Observed absolute values and baseline values are listed in Table 1 and Table 2, respectively.

(4) *K-index*

K-indices are calculated for every 3-hour interval measuring the amplitudes of the H- and D-component magnetic fields from the quiet-day variations. The definition of the K-indices at Syowa Station is as follows:

<u>K-index</u>	<u>Deviation</u>	<u>K-index</u>	<u>Deviation</u>
0	: 0 – 25 nT	5	: 350 – 600 nT
1	: 25 – 50	6	: 600 – 1000
2	: 50 – 100	7	: 1000 – 1650
3	: 100 – 200	8	: 1650 – 2500
4	: 200 – 350	9	: 2500 and more

The ordinary magnetogram is also available on chart papers with a recording speed of 5 cm/hr. The sensitivity of each component on the chart papers is about 100 nT/cm. Table 3 gives the K-indices at Syowa Station in February 2000 – January 2001. Inquiries or requests for the data copies of the magnetic field measurements should be addressed to World Data Center for Aurora in NIPR.

3.2. ELF-VLF waves

The natural ELF-VLF wave receiving system at the remote station has consisted of a triangle-shaped three turn loop antenna (10 m in height, 20 m in the bottom side), a pre-amplifier and a main amplifier with gains of 60 and 40 dB, respectively. The ELF-VLF wave intensities at the frequency bands of 0.35, 0.75, 1.2, 2, 4, 8, 30, 60, 95 kHz were obtained from wide band waveforms using a 9-channel filter bank and detectors. The ELF-VLF emissions within the intensity range of 10^{-17} to 10^{-13} W/m² Hz were detectable with this system. These data were recorded continuously in digital form at the sampling rate of 1 Hz. Some of the wide-band ELF-VLF signals up to 10 kHz were recorded on 8 mm video tape recorders. The wide-band recording was executed during 900 - 1300 UT on Sunday - Friday.

3.3. Ionosphere

Cosmic noise absorption at 30 MHz was observed with a broad-beam riometer, which has been installed at the remote station on West Ongul Island since 1981. Its beam half-width is 60°. A receiver used is made by La Jolla Science, and bandwidth and time constant are 150 kHz and 0.25 s, respectively. The riometer data were recorded in digital form at the sampling rate of 1 Hz in the UAPM system.

Data of ionospheric vertical sounders, broad-beam riometers (20 and 30 MHz), HF field strength receivers (8 and 10 MHz) and the VHF auroral radar (50 and 112 MHz) were recorded with other observation systems at Syowa Station, and the observational results have been published in another JARE Data Report (Ionosphere). Inquiries and requests for the data copies are to be addressed to:

World Data Center for Ionosphere
Communications Research Laboratory
2-1, Nukui-Kitamachi 4-chome, Koganei-shi,
Tokyo 184-8795, Japan.

3.4. Aurora

(1) *CCD all-sky imager*

All-sky observation of aurora was made by a CCD all-sky imager which was installed at Syowa Station by JARE-39. Panchromatic auroral images are taken every twenty seconds with an exposure time of 2 sec. Image data are saved both in a DVD-RAM disk for main use and in a DLT (digital linear tape) for backup. An observation list for the CCD all-sky imager is given in Table 4. Inquiries or requests for the all-sky data should be addressed to World Data Center for Aurora in NIPR. Observation by the film-type all-sky camera which have been operated until the end of the 1997 season was terminated on April 8, 1998.

(2) *Aurora TV camera*

All-sky observation of aurora was also made by an all-sky TV camera newly introduced at Syowa Station by JARE-40. The TV camera consists of an image intensifier and an interline CCD camera. Video signal from the CCD camera is recorded in S-VHS video tapes. Inquiries or requests for the all-sky data should be addressed to World Data Center for Aurora in NIPR.

(3) *Meridian-scanning photometer*

A meridian-scanning photometer (SPM) measures intensities of auroral emissions along a geomagnetic meridian at the wavelengths of 557.7 nm (OI), 630.0 nm (OI), 777.4 nm (OI), 844.6 nm (OI), 427.8 (N₂⁺), 486.1 nm (H_β), and 487.4 nm (Back-ground of H_β). The photometers have a field-of-view of 3 degrees except for 6 degrees for the channels of H_β and its background. A scan along a meridian is triggered every 20 s starting from the equatorward horizon to the poleward horizon, and requires approximately 18 s. Shutters of the photometers are closed during every first

scan of hour to obtain dark correction signals. Each photometer has two outputs of which signal gains differ exactly by ten times to enlarge its dynamic range. The output and scanning angle data are recorded with a PC at a sampling frequency of 10 Hz with a depth of 16 bits for each channel. The photometers are removable from a scanner for yearly calibration of sensitivity. We have two identical sets of photometers. While one is in operation at Syowa Station, the other is calibrated at NIPR. Observations were carried out during 101 clear nights from March 1 until October 4 in 2000.

4. Compiled Digital Data Format

MO media has been added since 1998 recorded by ATLAS (AT compatible computer with QNX operating system). This system has GPS clock and 16bit straight binary A/D converter (from -10V to 10V). Data in MO are written by Common Data Format (CDF) based on NASA NSSDC (see [1] or [2] for more detail of CDF). Each record has one time stamp and 16 kinds of data. Variable names of CDF for each data are follows;

EPOCH: Time stamp (unit: CDF Epoch)

MGFH: H component of fluxgate magnetometer

MGFD: D component of fluxgate magnetometer

MGFZ: Z component of fluxgate magnetometer

ULFH: H component of induction coil

ULFD: D component of induction coil

ULFZ: Z component of induction coil

CNA: CNA

VLF350: Intensity of natural VLF wave at 350 Hz

VLF750: Intensity of natural VLF wave at 750 Hz

VLF1.2k: Intensity of natural VLF wave at 1.2 kHz

VLF2.0k: Intensity of natural VLF wave at 2.0 kHz

VLF4.0k: Intensity of natural VLF wave at 4.0 kHz

VLF8.0k: Intensity of natural VLF wave at 8.0 kHz

VLF30k: Intensity of natural VLF wave at 30 kHz

VLF60k: Intensity of natural VLF wave at 60 kHz

VLF95k: Intensity of natural VLF wave at 95 kHz.

Each CDF valuable has 5 attributes. The names of attributes and characteristics are as follows;

Attributes (based on CDF standard attribute name)

VALIDMIN: Minimum valid value of raw AD data (usually, 0).

VALIDMAX: Maximum valid value of raw AD data (usually, 65534)

SCALEMIN: Minimum value as unit for VALIDMIN

SCALEMAX: Maximum value as unit for VALIDMAX

UNIT: Unit (e.g. nT, V/mHz, dB: written by characters)

Using these valuables, user can convert from A/D value to physical value by the following equation.

$$\begin{aligned} \text{(Physical value)} = & \text{SCALEMIN} + \\ & (\text{SCALEMAX}-\text{SCALEMIN})/(\text{VALIDMAX}-\text{VALIDMIN}) * \\ & ((\text{Variable data})-\text{VALIDMIN}) \end{aligned}$$

[1] CDF User's Guide (Version2.6) NASA/GSFC/NSSDC,

[2] http://nssdc.gsfc.nasa.gov/cdf/cdf_home.html

Acknowledgments

We would like to acknowledge all the members of the 41st Japanese Antarctic Research Expedition (JARE-41) for their support to the upper atmosphere physics observations at Syowa Station. The publication of this report was supported by the Upper Atmosphere Physics Research Division, World Data Center for Aurora and the Information Science Center of the National Institute of Polar Research.

References

- Arisawa, T., Kato, Y., Otaka, K., Inamori, Y., Kaneko, M. and Taguchi, M. (1997): Upper atmosphere physics data obtained at Syowa Station in 1995. JARE Data Rep., **225** (Upper Atmos. Phys. 15), 204p.
- Fujii, R., Sato, N. and Fukunishi, H. (1985): Upper atmosphere physics data, Syowa Station, 1982. JARE Data Rep., **105** (Upper Atmos. Phys. 2), 266p.
- Fujii, R., Kotake, N., Murata, I., Nozaki, K., Umetsu, M., Makita, K., Minatoya, H. and Yukimatu, A. (1994): Upper atmosphere physics (UAP) data obtained at Syowa and Asuka Stations in 1991. JARE Data Rep., **193** (Upper Atmos. Phys. 11), 208p.
- Kadokura, A., Uchida, K., Kurihara, N., Kimura, K., Okamura, H., Ariyoshi, H., Yukimatsu, A. and Ejiri, M. (1992): Upper atmosphere physics data, Syowa and Asuka Stations, 1989. JARE Data Rep., **171** (Upper Atmos. Phys. 9), 335p.
- Kawana, S., Kikuchi, M., Sakanoi, T., Yumisashi, I., and Taguchi, M. (1998): Upper atmosphere physics data obtained at Syowa Station in 1996. JARE Data Rep., **233** (Upper Atmos. Phys.16), 202p.
- Kikuchi, T., Ohwada, T., Oginasa, T., Uchida, K., Sakurai, H., Yamagishi, H. and Sato, N. (1988): Upper atmosphere physics data, Syowa Station, 1986. JARE Data Rep., **138** (Upper Atmos. Phys. 6), 276p.
- Maegawa, K., Yamaoka, N., Kawahara, T. D., Tsutsumi, M., Nakamoto, H., Takeshita, S., Kikuchi, M., Kadokura, A. and Taguchi, M. (2000): Upper atmosphere physics data obtained at Syowa Station in 1999. JARE Data Rep., **252** (Upper Atmos. Phys. 19), 200p.

- Miyaoka, H., Uchida, K., Mukai, H., Saito, H., Akamatsu, J., Shibuya, K., Sakai, R., Ayukawa, M. and Sato, N. (1990): Upper atmosphere physics data, Syowa and Asuka Stations, 1987. JARE Data Rep., **159** (Upper Atmos. Phys. 7), 306p.
- Obara, N., Wakino, Y., Kubota, M., Iwasaki, K., Nishimura, H. and Kadokura, A. (1996): Upper atmosphere physics data obtained at Syowa Station in 1994. JARE Data Rep., **209** (Upper Atmos. Phys. 14), 208p.
- Okano, S., Meki, K., Sakanoi, K., Kusano, K., Kikuchi, M., Kadokura, A., and Taguchi, M. . (2000): Upper atmosphere physics data obtained at Syowa Station in 1998. JARE Data Rep., **250** (Upper Atmos. Phys. 18), 200p.
- Ono, T., Tsunomura, S., Ejiri, M., Fujii, R. and Sato, N. (1986): Upper atmosphere physics data, Syowa Station, 1984. JARE Data Rep., **118** (Upper Atmos. Phys. 4), 271p.
- Ono, T., Nakajima, H., Satoh, M., Ohtaka, K., Kawahara, M. and Kumade, A. (1993): Upper atmosphere physics data, Syowa and Asuka Stations, 1990. JARE Data Rep., **186** (Upper Atmos. Phys. 10), 222p.
- Sakurai, H., Shibasaki, K., Fujii, R. and Sato, N. (1985): Upper atmosphere physics data, Syowa Station, 1983. JARE Data Rep., **108** (Upper Atmos. Phys. 3), 212p.
- Sato, N., Fujii, R., Fukunishi, H. and Nakajima, D. (1984): Upper atmosphere physics data, Syowa Station, 1981. JARE Data Rep., **93** (Upper Atmos. Phys. 1), 206p.
- Sato, N., Uchida, K., Saka, O., Yamaguchi, K., Iguchi, S., Aoki, T. and Miyaoka, H. (1991): Upper atmosphere physics data, Syowa and Asuka Stations, 1988. JARE Data Rep., **169** (Upper Atmos. Phys. 8), 212p.
- Takeuchi, S., Ookawa, T., Setoguchi, T., Ozeki, J., Kikuchi, M., Kadokura, A. and Taguchi, M. (1999): Upper atmosphere physics data obtained at Syowa Station in 1997. JARE Data Rep., **243** (Upper Atmos. Phys. 17), 204p.
- Tonegawa, Y., Rokuyama, K., Makita, Y., Yang H., Kadokura, A. and Sato, N. (1996): Upper atmosphere physics data obtained at Syowa Station in 1993. JARE Data Rep., **208** (Upper Atmos. Phys. 13), 202p.
- Uchida, K., Tonegawa, Y., Fujii, R. and Sato, N. (1988): Computer compilatory process of the data acquired by the conjugate observation system in Iceland. Nankyoku Shiryo (Antarct. Rec.), **32**, 238-257 (in Japanese with English abstract).
- Yamagishi, H. (1990): Development of Optical Disk data base system for Syowa Station-Iceland geomagnetically conjugate observation. Nankyoku Shiryo (Antarct. Rec.), **34**, 242-262 (in Japanese with English abstract).
- Yamagishi, H., Ayukawa, M., Matsumura, S., Sakurai, H. and Sato, N. (1987): Upper atmosphere physics data, Syowa Station, 1985. JARE Data Rep., **128** (Upper Atmos. Phys. 5), 272p.
- Yamazaki, I., Takahashi, Y., Mineno, H., Kamata, M., Ogawa, Y. and Kadokura, A. (1995): Upper atmosphere physics data obtained at Syowa Stations in 1992. JARE Data Rep., **205** (Upper Atmos. Phys. 12), 207p.

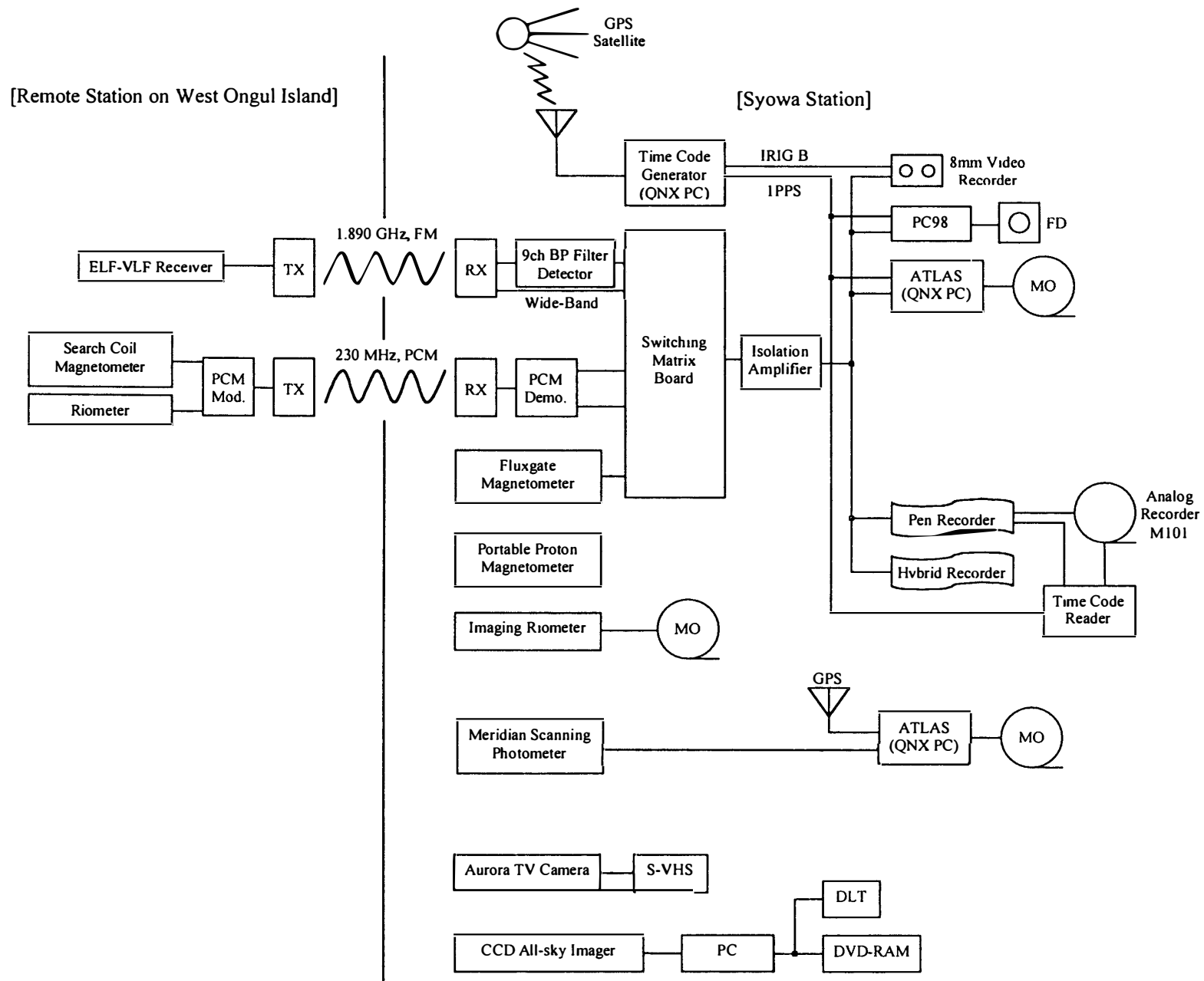

Fig. 1. Block diagram of the "Upper Atmosphere Physics" monitoring system at Syowa Station in 2000.

Table 1. Absolute values of geomagnetic field at Syowa Station in March 2000–January 2001.

DATE	TIME hh:mm	DECLINATION (deg:min)	TIME hh:mm	DIP ANGLE (deg:min)	TOTAL (nT)	HORIZONTAL (nT)	VERTICAL (nT)
2000 3/ 3	10:36	-48:29.89	10:59	-63:47.521	43387.6	19161.3	-38927.2
	10:39	-48:29.573	11:02	-63:47.492	43387.3	19161.5	-38926.8
	10:43	-48:29.163	11:06	-63:47.540	43388.8	19161.6	-38928.4
	10:46	-48:28.721	11:10	-63:47.585	43389.2	19161.3	-38929.0
mean	10:41	-48:29.34	11:04	-63:47.53	43388.2	19161.4	-38927.8
2000 3/26	8:04	-48:34.406	8:27	-63:45.673	43384.2	19180.7	-38913.9
	8:08	-48:34.415	8:32	-63:45.685	43385.1	19181.0	-38914.7
	8:13	-48:34.258	8:37	-63:45.681	43387.0	19181.9	-38916.4
	8:17	-48:34.267	8:44	-63:45.713	43388.1	19182.0	-38917.5
mean	8:10	-48:34.34	8:35	-63:45.69	43386.1	19181.4	-38915.6
2000 3/26	11:13	-48:31.085	11:37	-63:48.081	43380.5	19151.8	-38923.9
	11:16	-48:31.283	11:40	-63:48.037	43380.5	19152.3	-38923.7
	11:20	-48:31.188	11:44	-63:48.221	43381.3	19150.6	-38925.5
	11:23	-48:31.417	11:48	-63:48.246	43381.1	19150.2	-38925.5
mean	11:18	-48:31.24	11:42	-63:48.15	43380.8	19151.2	-38924.6
2000 3/26	12:39	-48:29.30	13:01	-63:48.729	43383.3	19145.7	-38930.1
	12:42	-48:29.152	13:04	-63:48.804	43383.3	19144.9	-38930.5
	12:46	-48:29.210	13:08	-63:48.667	43384.3	19146.9	-38930.6
	12:49	-48:29.150	13:12	-63:48.596	43385.5	19148.2	-38931.3
mean	12:44	-48:29.20	13:06	-63:48.70	43384.1	19146.4	-38930.6
2000 3/26	13:58	-48:27.796	14:23	-63:48.231	43394.6	19156.4	-38937.5
	14:02	-48:28.004	14:27	-63:48.188	43392.4	19155.9	-38935.2
	14:06	-48:27.971	14:30	-63:48.108	43390.9	19156.1	-38933.4
	14:11	-48:27.787	14:34	-63:48.060	43391.4	19156.9	-38933.6
mean	14:04	-48:27.89	14:29	-63:48.15	43392.8	19156.3	-38934.9
2000 4/14	11:21	-48:31.212	11:42	-63:47.875	43398.9	19162.3	-38939.3
	11:24	-48:31.169	11:46	-63:47.960	43399.7	19161.7	-38940.5
	11:28	-48:31.121	11:50	-63:48.071	43399.7	19160.4	-38941.2
	11:31	-48:31.308	11:55	-63:47.935	43400.4	19162.3	-38941.0
mean	11:26	-48:31.20	11:48	-63:47.96	43399.7	19161.7	-38940.5
2000 5/27	11:35	-48:27.977	12:09	-63:46.579	43411.3	19182.4	-38943.2
	11:41	-48:28.079	12:16	-63:46.608	43412.1	19182.4	-38944.1
	11:45	-48:28.342	12:22	-63:46.700	43414.2	19182.3	-38946.5
	11:50	-48:28.358	12:29	-63:46.483	43424.3	19189.3	-38954.4
mean	11:43	-48:28.19	12:11	-63:46.59	43416.8	19184.1	-38947.0
2000 6/17	10:39	-48:31.183	11:01	-63:45.773	43387.9	19181.2	-38917.7
	10:42	-48:30.992	11:05	-63:45.758	43387.3	19181.1	-38917.1
	10:45	-48:31.067	11:10	-63:45.790	43385.7	19180.1	-38915.8
	10:49	-48:31.204	11:14	-63:45.921	43383.1	19177.4	-38914.3
mean	10:44	-48:31.11	11:07	-63:45.81	43385.8	19180.0	-38916.2
2000 7/25	10:31	-48:32.4	10:59	-63:46.431	43389.7	19174.6	-38923.0
	10:35	-48:32.342	11:03	-63:46.371	43390.6	19175.7	-38923.5
	10:37	-48:32.335	11:06	-63:46.354	43391.5	19176.2	-38924.2
	10:40	-48:32.242	11:09	-63:46.371	43392.7	19176.6	-38925.4
mean	10:36	-48:32.33	11:04	-63:46.38	43391.1	19175.8	-38924.0
2000 8/16	10:49	-48:31.019	11:24	-63:46.365	43376.1	19169.3	-38910.5
	10:54	-48:30.860	11:30	-63:46.487	43375.8	19167.8	-38910.9
	10:59	-48:30.419	11:36	-63:46.575	43376.1	19166.9	-38911.7
	11:05	-48:30.102	11:40	-63:46.625	43377.4	19167.0	-38913.1
mean	10:57	-48:30.60	11:32	-63:46.51	43376.6	19167.8	-38911.5

DATE	TIME hh:mm	DECLINATION (deg:min)	TIME hh:mm	DIP ANGLE (deg:min)	TOTAL (nT)	HORIZONTAL (nT)	VERTICAL (nT)
2000 9/ 9	10:28	-48:33.625	10:48	-63:45.971	43365.4	19169.0	-38898.6
	10:31	-48:33.633	10:51	-63:45.890	43366.8	19170.6	-38899.4
	10:34	-48:33.358	10:55	-63:45.838	43368.5	19171.9	-38900.7
	10:37	-48:33.104	10:58	-63:45.796	43369.5	19172.8	-38901.3
mean	10:32	-48:33.43	10:53	-63:45.87	43367.3	19171.1	-38900.0
2000 10/12	11:41	-48:30.310	12:12	-63:46.812	43385.3	19168.3	-38921.2
	11:45	-48:30.688	12:17	-63:46.592	43387.6	19171.8	-38922.0
	11:50	-48:31.056	12:21	-63:46.442	43390.3	19174.7	-38923.6
	11:55	-48:31.575	12:25	-63:46.565	43390.6	19173.5	-38924.6
mean	11:48	-48:30.91	12:19	-63:46.60	43388.2	19172.1	-38922.9
2000 11/18	11:00	-48:32.992	11:20	-63:46.404	43355.2	19159.6	-38891.9
	11:04	-48:33.235	11:23	-63:46.448	43355.3	19159.2	-38892.2
	11:08	-48:33.392	11:26	-63:46.521	43354.2	19157.9	-38891.7
	11:12	-48:33.235	11:30	-63:46.579	43354.0	19157.1	-38891.8
mean	11:06	-48:33.21	11:25	-63:46.49	43354.7	19158.4	-38891.9
2000 12/15	10:45	-48:33.825	11:18	-63:46.158	43337.3	19154.5	-38874.5
	10:48	-48:33.850	11:21	-63:46.125	43336.9	19154.7	-38874.0
	11:06	-48:33.783	11:25	-63:46.077	43340.2	19156.7	-38876.6
	11:14	-48:33.796	11:28	-63:46.169	43341.0	19156.0	-38877.9
mean	11:00	-48:33.81	11:23	-63:46.13	43338.9	19155.5	-38875.7
2000 12/15	11:47	-48:31.046	12:07	-63:46.981	43335.1	19144.2	-38877.1
	11:50	-48:31.362	12:10	-63:46.940	43336.5	19145.3	-38878.1
	11:53	-48:31.388	12:13	-63:47.025	43336.4	19144.3	-38878.5
	11:56	-48:30.846	12:16	-63:47.094	43335.3	19143.0	-38877.9
mean	11:51	-48:31.16	12:11	-63:47.01	43335.6	19144.2	-38877.9
2001 1/18	11:21	-48:30.227	11:43	-63:44.992	43327.2	19163.2	-38858.9
	11:25	-48:30.671	11:46	-63:44.973	43328.1	19163.8	-38859.6
	11:29	-48:31.073	11:49	-63:44.935	43328.9	19164.6	-38860.1
	11:33	-48:31.304	11:53	-63:44.875	43330.6	19166.0	-38861.3
mean	11:27	-48:30.82	11:48	-63:44.94	43328.8	19164.4	-38860.0

Table 2. Baseline values of fluxgate magnetometer at Syowa Station
in March 2000–January 2001.

DATE	TIME (UT) hh:mm	H (nT)	D (nT)	Z (nT)
2000 03/26	12:56	18158.00	18719.254	-39073.11
2000 03/26	14:17	18157.84	18719.021	-39074.04
2000 04/14	11:38	18156.13	18718.644	-39073.55
2000 05/27	12:02	18156.89	18718.871	-39072.92
2000 06/17	10:56	18156.28	18718.871	-39072.29
2000 07/25	10:50	18158.95	18719.463	-39076.70
2000 08/16	11:14	18158.25	18719.167	-39073.27
2000 09/09	10:44	18158.27	18719.015	-39075.00
2000 10/12	12:04	18156.28	18718.542	-39071.61
2000 11/18	11:14	18151.62	18718.598	-39066.62
2000 12/15	07:01	18146.42	18720.205	-39062.36
2000 12/15	08:30	18147.32	18720.017	-39063.01
2000 12/15	11:13	18150.23	18718.904	-39062.40
2000 12/15	12:01	18150.29	18719.188	-39063.10
2001 01/18	11:38	18149.22	18716.733	-39064.27

Table 3. K-indeces at Syowa Station in February 2000–January 2001.

	FEBRUARY	MARCH	APRIL	MAY	JUNE	JULY	AUGUST	SEPTEMBER	OCTOBER	NOVEMBER	DECEMBER	JANUARY
1	3221 2223	3544 3355	4321 1345	3542 2345	5432 1203	4330 1110	3332 2545	5442 2246	4442 2212	4221 1225	3312 3221	2112 1022
2	5212 2322	4431 2113	5553 2125	4334 4356	3320 1223	0200 0012	6531 1145	6554 3313	1122 2444	4321 1111	1112 3322	2111 1222
3	3322 3233	2111 2132	4432 2216	2332 1365	5433 3222	3122 3104	4432 2223	2211 1044	4554 3211	1121 1124	2332 4333	4552 2112
4	4221 0212	2011 1111	5521 2366	3222 1234	2221 0346	4402 1112	5443 3445	3222 1264	2344 4565	3763 4554	3432 3134	4232 4323
5	3112 2344	1322 1234	6510 0211	3452 3214	6464 4222	3134 3312	3335 3336	3321 1343	6664 5576	5421 4354	3432 2101	3221 1124
6	5553 3457	2333 1244	3542 2587	5532 2126	5333 3210	2311 1221	5542 3235	2110 1333	3211 1110	4554 5664	3322 3334	3321 0212
7	6443 4455	4542 3345	6452 2355	4421 0010	2122 3236	3211 0123	2222 2224	4433 2335	2211 2210	6665 5242	4452 3335	3441 1223
8	6522 3353	4433 3354	3343 2145	0011 0113	5556 5755	3311 0210	3212 1122	4333 4335	0211 0024	2333 3323	5533 4334	3321 1345
9	3532 3323	4321 1102	4522 3455	2311 1445	1222 1101	0021 1104	3211 0023	5122 1100	3111 1234	4421 3346	4543 3345	3222 3233
10	3342 2223	2122 2456	5633 2346	4521 1123	5444 3334	3442 3231	0563 3246	0112 0122	3333 2312	5665 6434	5532 1344	1121 2323
11	3643 2346	4532 3334	3322 1253	3421 0013	4434 3443	2543 3256	5664 3275	1111 1122	5652 2233	4422 3466	4321 2213	3222 3345
12	7557 5443	4452 2324	4441 0013	4553 1134	2331 2322	5213 0100	4776 5443	2423 3366	3112 2112	5443 4445	3322 1232	5432 2110
13	3333 3455	4411 1024	4521 0000	6322 1333	2432 2324	0125 4324	6532 1114	6631 1124	7642 3333	2422 3234	4222 1122	1223 2213
14	5544 5345	4221 1124	0111 1010	5411 1133	4232 2344	4543 3564	1111 2235	3221 1222	5764 3756	3421 2122	1122 2112	3332 1233
15	5432 2236	2201 1100	2311 1143	5422 1122	3331 3244	4545 6786	4412 1221	1310 1026	2312 2224	2221 1121	2111 2210	3221 2335
16	3321 1334	0111 1101	3544 3223	5533 2235	4110 1103	6554 5321	3321 2222	4321 2466	5422 2224	2111 1023	0212 2222	2122 2332
17	2212 3231	1212 1100	4432 1114	6633 1133	3001 1112	5432 1111	4422 1013	5532 4457	5522 2235	3312 1110	3322 4342	3221 2333
18	1211 0100	0111 1132	4311 0023	3321 1012	1011 0334	4431 1334	2310 0000	6454 4325	3322 2235	1111 1234	3432 2343	2122 1114
19	0122 1111	3321 1110	5531 2221	3222 1113	4400 0110	5211 0325	3010 0002	4333 4336	4422 2223	4332 2123	3422 2321	2112 1123
20	1122 1013	1112 2100	3432 2333	2111 1132	4211 2001	6765 3125	1001 0003	5522 2213	2211 0111	3232 4443	2221 1121	2232 3344
21	5532 3531	0111 1100	3413 2123	3431 0023	1101 0024	4211 2213	4632 2357	3422 2124	1111 1211	4422 3344	2112 2312	4423 4454
22	2221 2222	3321 1233	2222 1122	3433 2222	4232 2122	3333 3334	3111 0000	4321 1122	2212 3454	3222 3332	3321 2223	5333 3334
23	1112 3322	5432 3422	1122 1101	2321 2346	4531 3356	4421 1474	0012 3212	4411 1112	4443 3233	3422 2321	4653 3333	3423 3355
24	3554 4455	4422 3323	2543 3222	7755 4367	6453 1113	4421 1013	1442 1001	2111 1355	4433 3214	1322 2344	3431 1121	3422 4463
25	5443 3223	3332 1230	3111 1131	5544 3246	2120 0015	3311 1122	1211 0012	4323 2555	2122 3223	4422 1233	2122 4323	3212 0333
26	4433 1366	0111 1113	0011 1100	5534 2220	5666 4565	5153 3247	3122 1101	6553 3245	4341 2223	3333 3464	2422 1343	4442 2332
27	6322 2233	2211 1001	2023 3325	1322 1345	6343 3346	5310 0102	4111 1134	4342 2225	4112 1113	6555 4345	4321 3432	4322 1113
28	5542 4222	1221 0100	6432 2334	3432 2245	5531 2144	4473 3431	4323 2446	5522 2212	3223 3226	4564 5554	4322 2212	3322 3343
29	1322 2210	0111 1135	4422 1235	3431 2434	6532 1114	6454 3223	5663 2465	4412 2233	6664 3344	5675 5433	3531 2223	5522 1234
30		3211 1353	4521 1233	4464 3436	1011 0143	5611 1222	5432 2234	5663 3466	5333 2122	3322 2223	2222 2102	3421 0101
31		5443 3444		4632 2115		3432 2346	5533 2335		5422 2334		3112 1100	2233 4444

Table 4. Observation periods of a CCD all-sky imager at Syowa Station in 2000.

DATE	Hours (UT)									K-Index		
	h	m	s	h	m	s	h	m	s			
Mar. 1				21	34	00	~ 23	21	00		3544	3355
Mar. 2				20	18	00	~ 23	21	00		4431	2113
Mar. 3				20	21	00	~ 22	39	00		2111	2132
Mar. 4				20	23	00	~ 23	20	00		2011	1111
Mar. 5				20	12	00	~ 23	20	00		1322	1234
Mar. 6				20	13	00	~ 23	32	00		2333	1244
Mar. 10								19	09	00	2122	2456
Mar. 11	~ 00	18	00	19	57	00	~ 23	30	00		4532	3334
Mar. 12				19	40	00	~ 23	36	00		4452	2324
Mar. 13				19	41	00	~ 22	37	00		4411	1024
Mar. 14				19	49	00	~ 22	46	00		4221	1124
Mar. 15				19	11	00	~ 23	52	00		2201	1100
Mar. 16								19	16	00	0111	1101
Mar. 17	~ 00	03	00								1212	1100
Mar. 19								18	41	00	3321	1110
Mar. 20	~ 00	28	00								1112	2100
Mar. 22								18	39	00	3321	1233
Mar. 23	~ 00	15	00								5432	3422
Mar. 24				17	50	00	~ 23	40	00		4422	3323
Mar. 25				17	50	00	~ 23	32	00		3332	1230
Mar. 26				17	42	00	~ 22	03	00		0111	1113
Mar. 27								17	41	00	2211	1001
Mar. 28	~ 00	55	00					19	37	00	1221	0100
Mar. 29	~ 01	29	00					17	23	00	0111	1135
Mar. 30	~ 01	28	00					17	17	00	3211	1353
Mar. 31	~ 01	57	00					17	13	00	5443	3444
Apr. 1	~ 01	54	00					17	06	00	4321	1345
Apr. 2	~ 01	55	00					17	03	00	5553	2125
Apr. 3	~ 01	56	00								4432	2216
Apr. 4				16	52	00	~ 18	36	00		5521	2366
Apr. 5				17	33	00	~ 22	52	00		6510	0211
Apr. 6								16	40	00	3542	2587
Apr. 7	~ 02	13	00								6452	2355
Apr. 9								19	06	00	4522	3455
Apr. 10	~ 01	17	00								5633	2346
Apr. 12								16	19	00	4441	0013
Apr. 13	~ 02	36	00	16	20	00	~ 20	52	00		4521	0000
Apr. 16								17	16	00	3544	3223
Apr. 17	~ 02	51	00					15	53	00	4432	1114

DATE	Hours (UT)									K-Index	
	h	m	s	h	m	s	h	m	s		
Apr. 27	~ 01	37	00				15	17	00	2023	3325
Apr. 28	~ 02	23	00							6432	2334
May 2							22	19	00	4334	4356
May 3	~ 03	52	00							2332	1365
May 6							14	45	00	5532	2126
May 7	~ 00	16	00							4421	0010
May 9							15	48	00	2311	1445
May 10	~ 04	00	00							4521	1123
May 14				15	19	00	~ 16	35	00	5411	1133
May 16				03	18	00	~ 04	12	00	5533	2235
May 24							17	26	00	7755	4367
May 25	~ 04	25	00				14	54	00	5544	3246
May 26	~ 01	02	00							5534	2220
May 27							15	00	00	1322	1345
May 28	~ 04	26	00				15	3	00	3432	2245
May 29	~ 04	37	00				15	13	00	3431	2434
May 30	~ 04	40	00				14	53	00	4464	3436
May 31	~ 04	47	00							4632	2115
June 2							15	32	00	3320	1223
June 3	~ 04	42	00				14	54	00	5433	3222
June 4	~ 01	06	00							2221	0346
June 8							15	27	00	5556	5755
June 9	~ 04	58	40				17	50	00	1222	1101
June 10	~ 03	31	00							5444	3334
June 24				15	03	00	~ 18	08	00	6453	1113
June 26				16	54	00	~ 20	44	00	5666	4565
June 27							15	06	00	6343	3346
June 28	~ 01	13	00							5531	2144
June 30				15	01	00	~ 19	28	00	1011	0143
July 3				16	01	00	~ 19	00	00	3122	3104
July 4							19	47	00	4402	1112
July 5	~ 04	44	00				21	09	00	3134	3312
July 6	~ 03	59	00	16	51	00	~ 20	09	00	2311	1221
July 8				17	52	00	~ 23	47	00	3311	0210
July 12				01	47	00	~ 04	59	00	5213	0100
July 14				00	06	00	~ 04	01	00	4543	3564
July 23							18	15	00	4421	1474
July 24	~ 04	31	00				15	12	00	4421	1013

DATE	Hours (UT)									K-Index	
	h	m	s	h	m	s	h	m	s		
July 27				15	18	00	~ 17	29	00	5310	0102
July 30							15	15	00	5611	1222
July 31	~ 04	15	00				15	45	00	3432	2346
Aug. 1	~ 04	07	00							3332	2545
Aug. 2							22	26	00	6531	1145
Aug. 3	~ 04	08	00				19	41	00	4432	2223
Aug. 4	~ 04	10	00							5443	3445
Aug. 6							20	37	00	5542	3235
Aug. 7	~ 04	03	00				18	48	00	2222	2224
Aug. 8	~ 03	46	00							3212	1122
Aug. 17							15	54	00	4422	1013
Aug. 18	~ 03	24	00				15	46	00	2310	0000
Aug. 19	~ 03	14	00				15	43	00	3010	0002
Aug. 20	~ 03	13	00				15	47	00	1001	0003
Aug. 21	~ 00	53	00							4632	2357
Aug. 24							15	55	00	1442	1001
Aug. 25	~ 02	56	00	18	56	00	~ 22	46	00	1211	0012
Aug. 28				17	33	00	~ 22	15	00	4323	2446
Aug. 29							21	38	00	5663	2465
Aug. 30	~ 02	38	00							5432	2234
Aug. 31							16	21	00	5533	2335
Sep. 1	~ 02	18	00				17	46	00	5442	2246
Sep. 2	~ 02	21	00				17	24	00	6554	3313
Sep. 3	~ 02	52	00				16	30	00	2211	1044
Sep. 4	~ 02	12	00							3222	1264
Sep. 5							17	09	00	3321	1343
Sep. 6	~ 02	07	00				20	24	00	2110	1333
Sep. 7	~ 01	56	00				19	20	00	4433	2335
Sep. 8	~ 02	11	00							4333	4335
Sep. 12							17	17	00	2423	3366
Sep. 13	~ 01	09	00							6631	1124
Sep. 15				17	28	00	~ 23	04	00	1310	1026
Sep. 16							18	06	00	4321	2466
Sep. 17	~ 01	23	00				17	29	00	5532	4457
Sep. 18	~ 01	09	00	17	22	00	~ 20	19	00	6454	4325
Sep. 20							17	56	00	5522	2213
Sep. 21	~ 01	18	00				17	32	00	3422	2124
Sep. 22	~ 01	17	00				17	26	00	4321	1122
Sep. 23	~ 01	13	00				17	29	00	4411	1112

DATE	Hours (UT)									K-Index	
	h	m	s	h	m	s	h	m	s		
Sep. 26	~ 01	08	00	17	57	00	~ 21	10	00	6553	3245
Sep. 27				17	40	00	~ 23	57	00	4342	2225
Sep. 28							18	05	00	5522	2212
Sep. 29	~ 00	45	00							4412	2233
Sep. 30							18	08	00	5663	3466
Oct. 1	~ 00	26	00							4442	2212
Oct. 4				22	46	00	~ 23	55	00	2344	4565

Appendix

Summary plots of the Upper Atmosphere Physics Monitoring data in 2000

- Plotted data from top:

H : northward component of the magnetic variation
D : eastward component of the magnetic variation
Z : downward component of the magnetic variation

- Plotting vertical scale:

H, D, Z : 100 nT/div

SYOWA magnetogram (100 nT/div)

01 Jan.2000 (DAY:001)

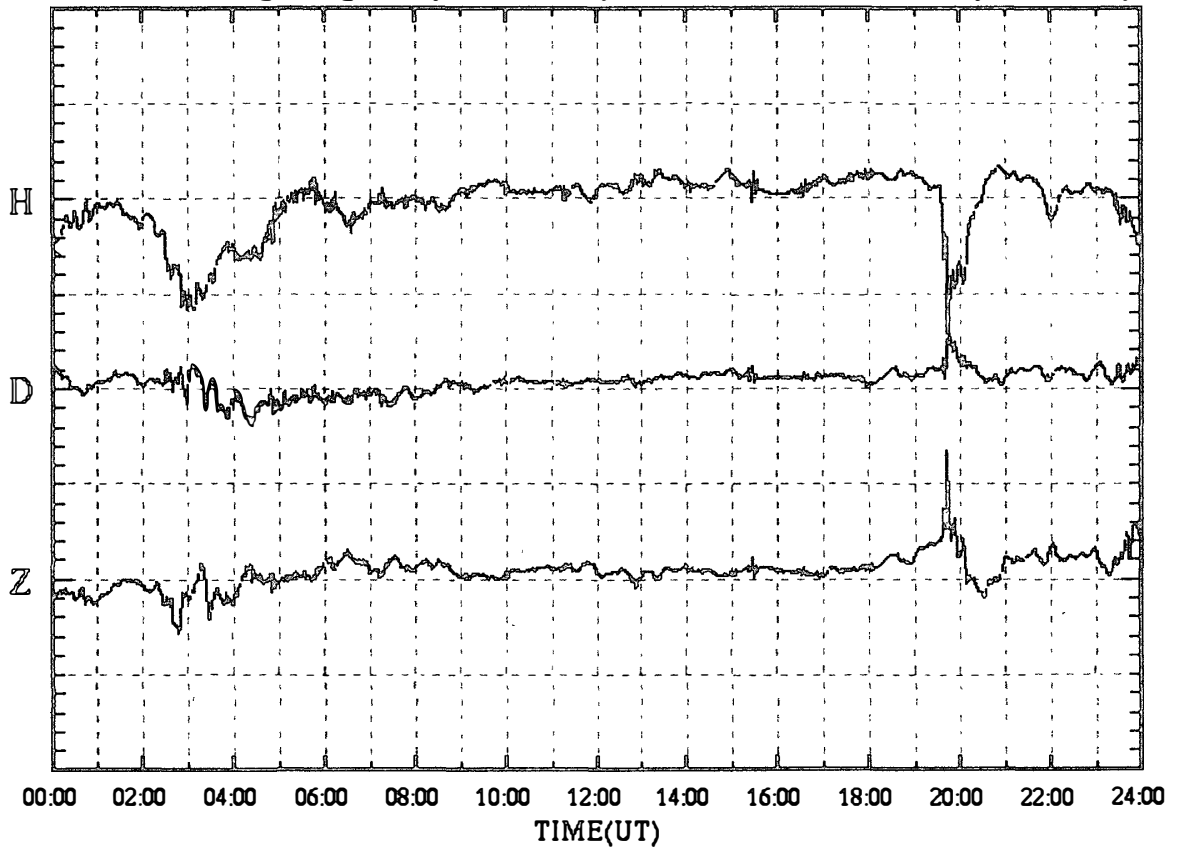

SYOWA magnetogram (100 nT/div)

02 Jan.2000 (DAY:002)

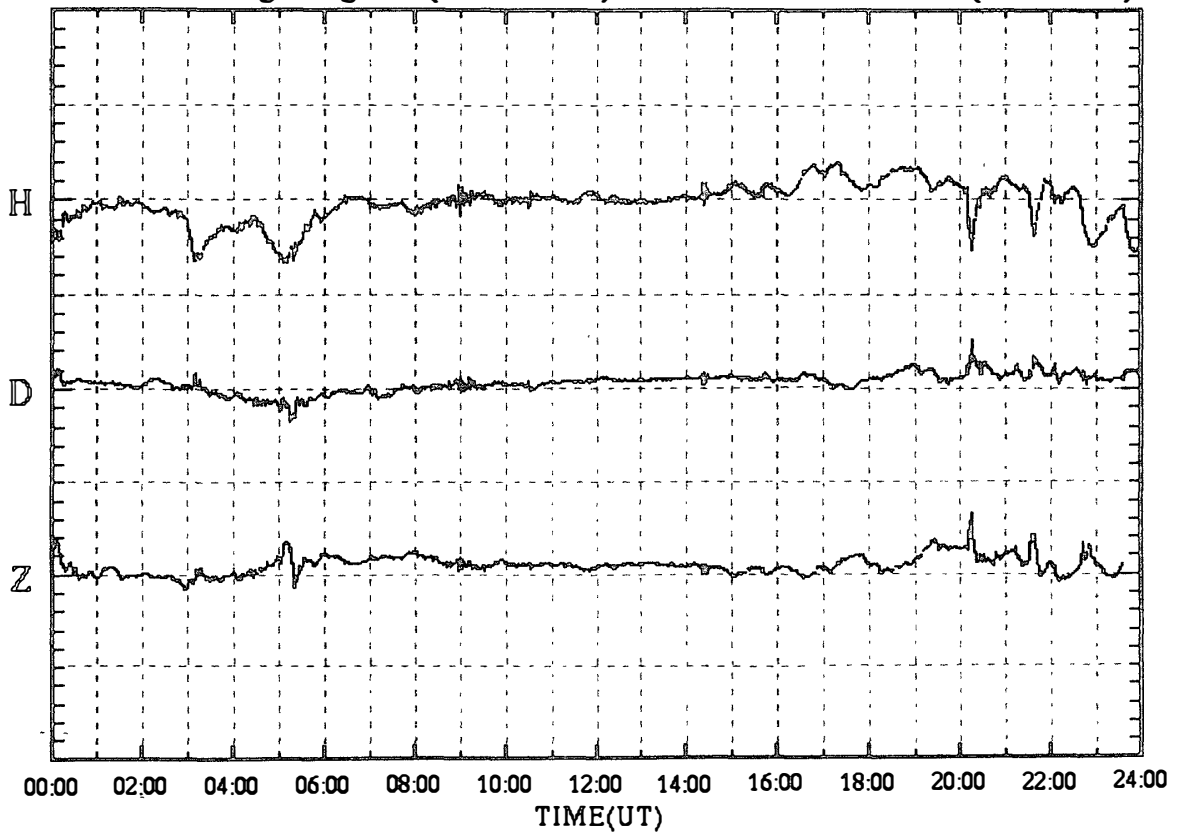

SYOWA magnetogram (100 nT/div)

03 Jan.2000 (DAY:003)

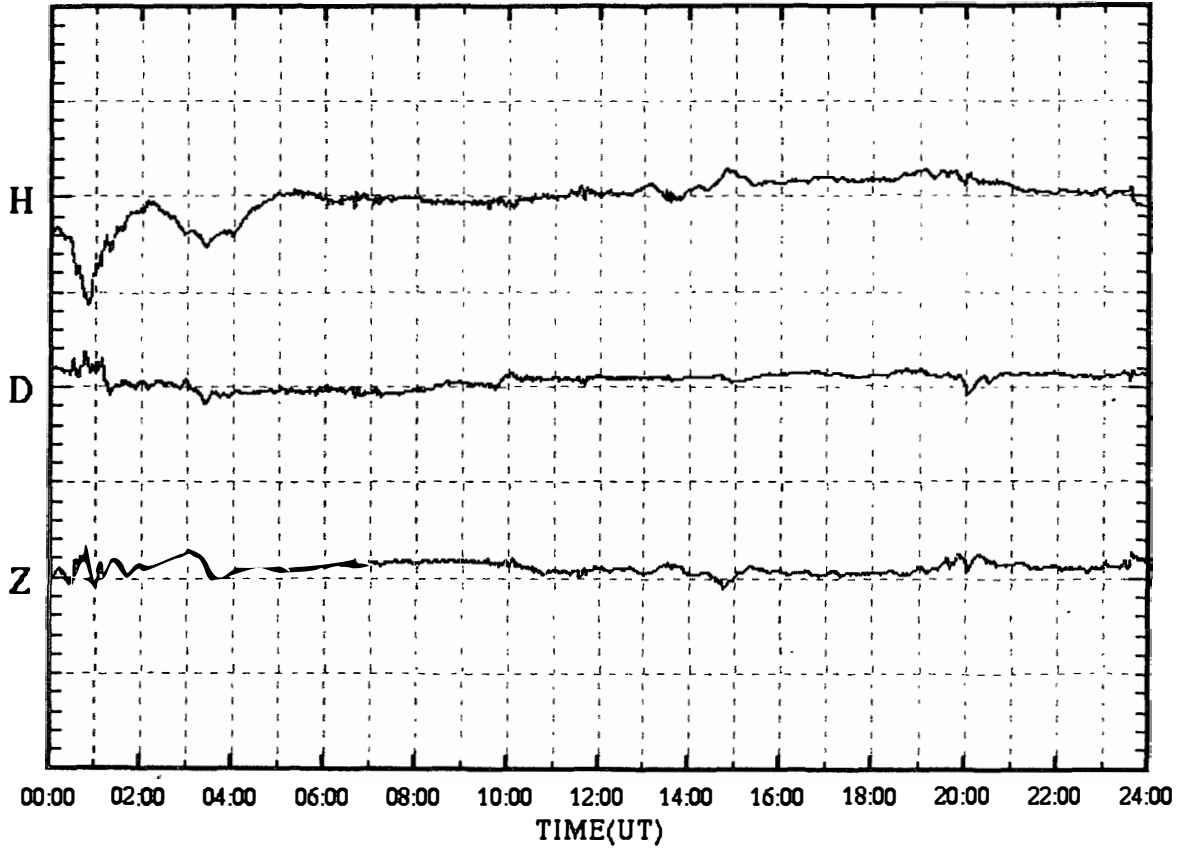

SYOWA magnetogram (100 nT/div)

04 Jan.2000 (DAY:004)

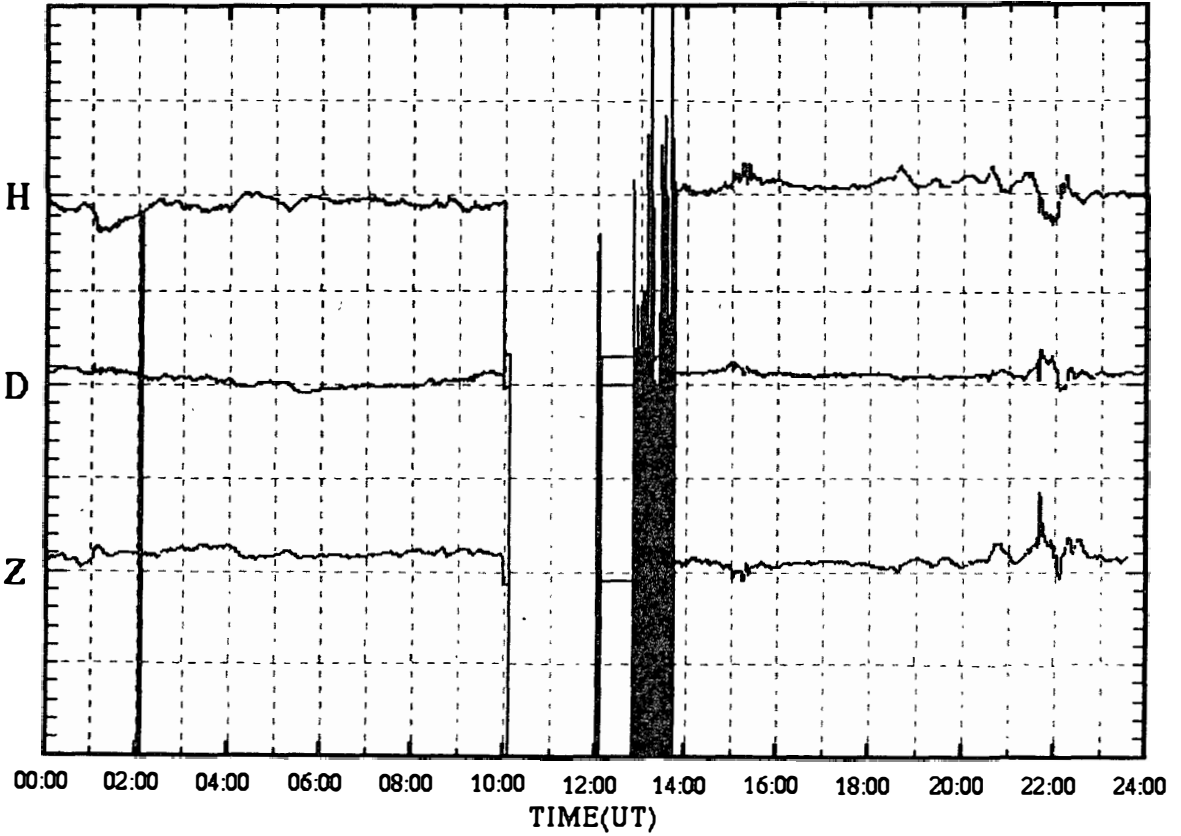

SYOWA magnetogram (100 nT/div)

05 Jan.2000 (DAY:005)

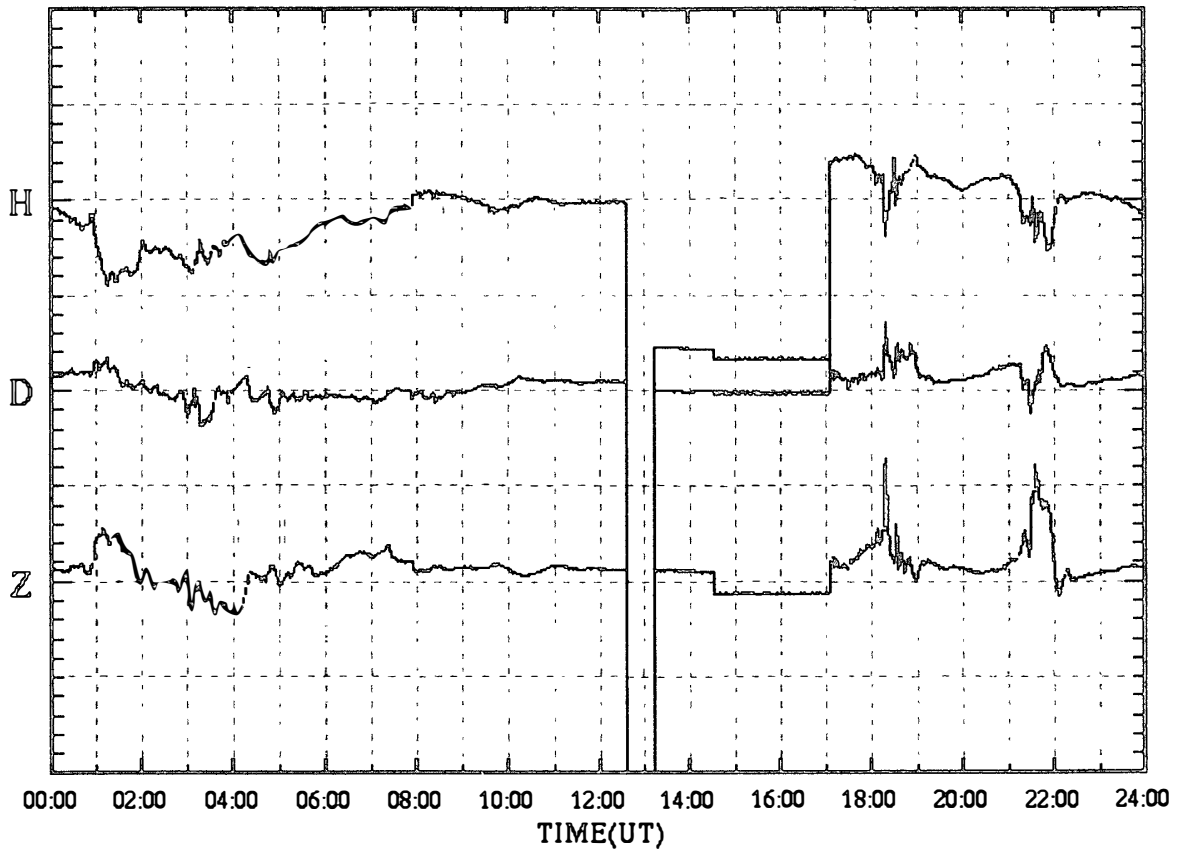

SYOWA magnetogram (100 nT/div)

06 Jan.2000 (DAY:006)

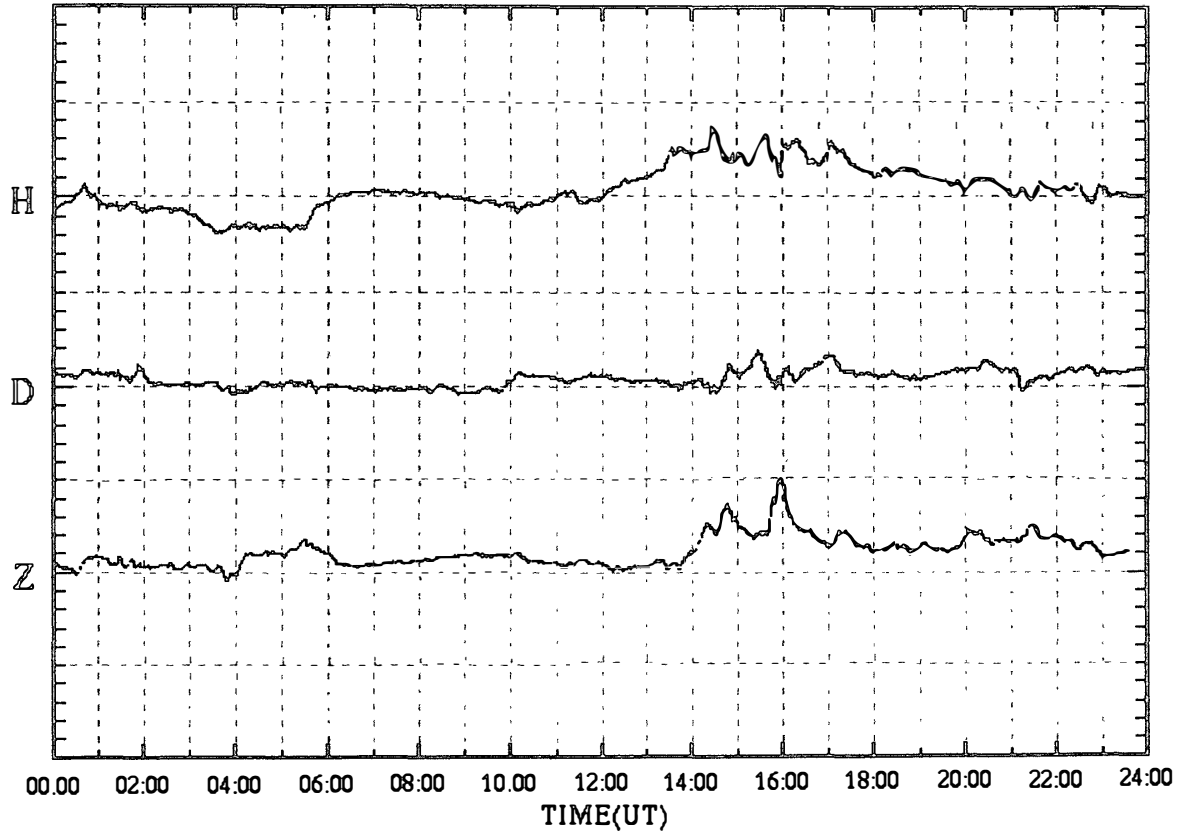

SYOWA magnetogram (100 nT/div)

07 Jan.2000 (DAY:007)

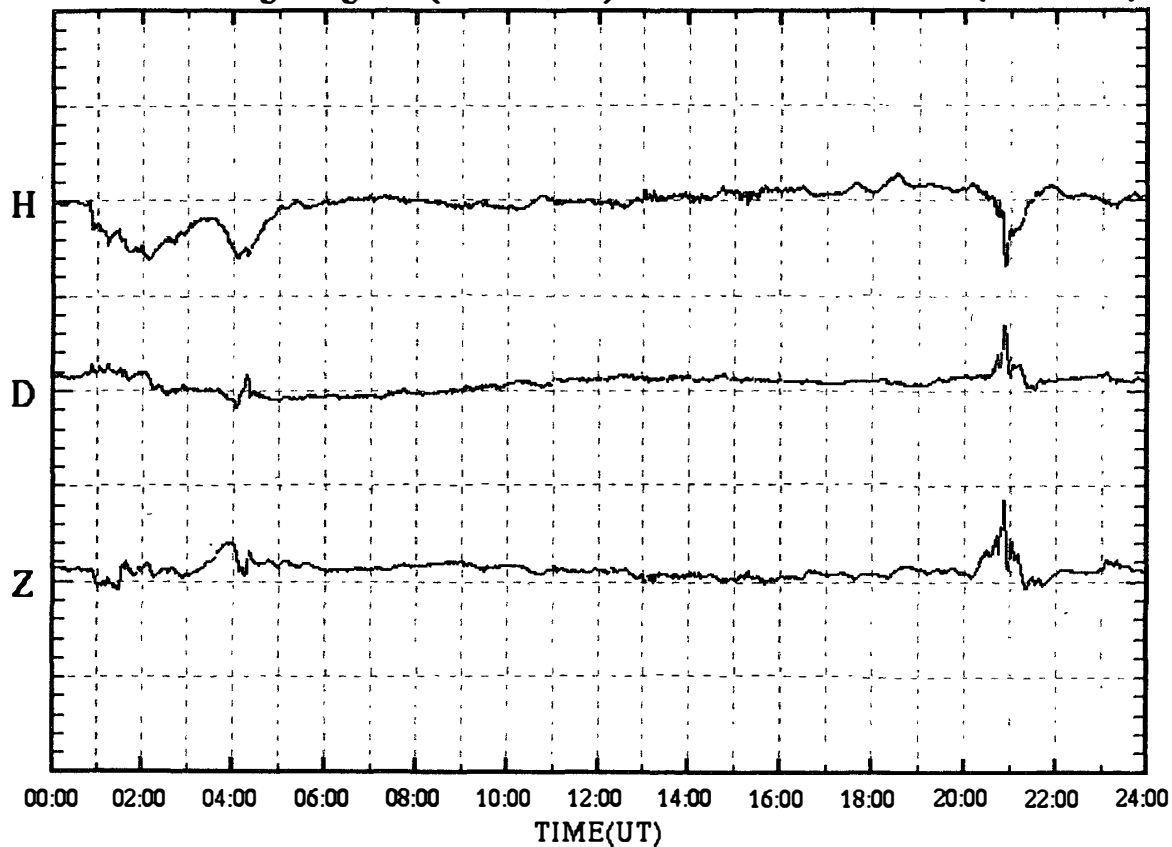

SYOWA magnetogram (100 nT/div)

08 Jan.2000 (DAY:008)

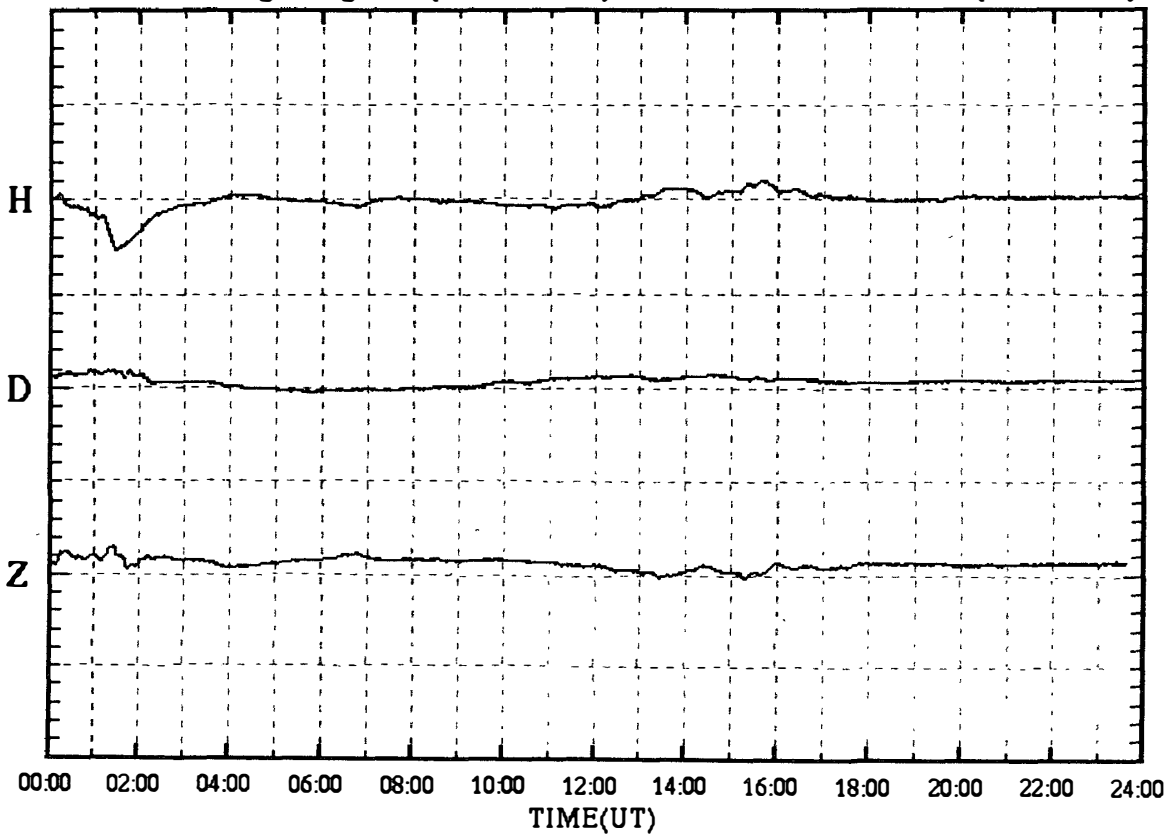

SYOWA magnetogram (100 nT/div)

09 Jan.2000 (DAY:009)

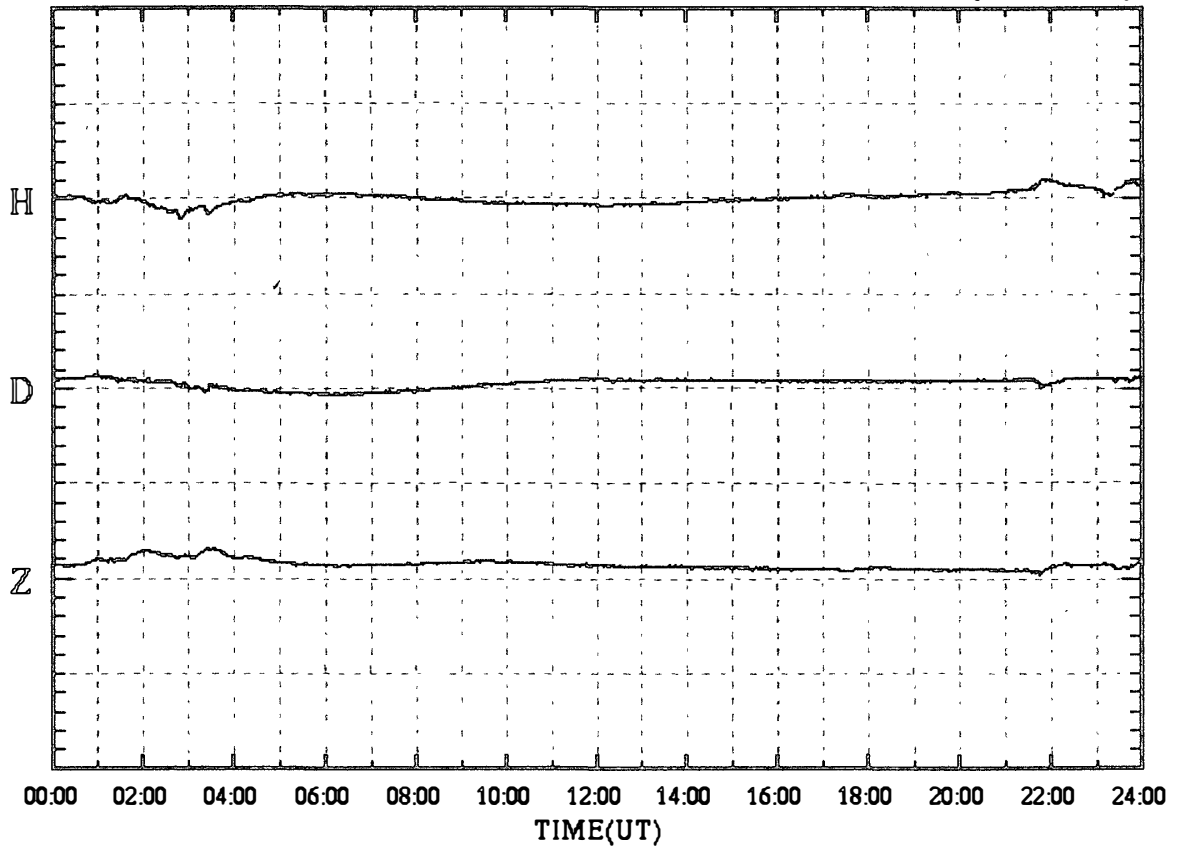

SYOWA magnetogram (100 nT/div)

10 Jan.2000 (DAY:010)

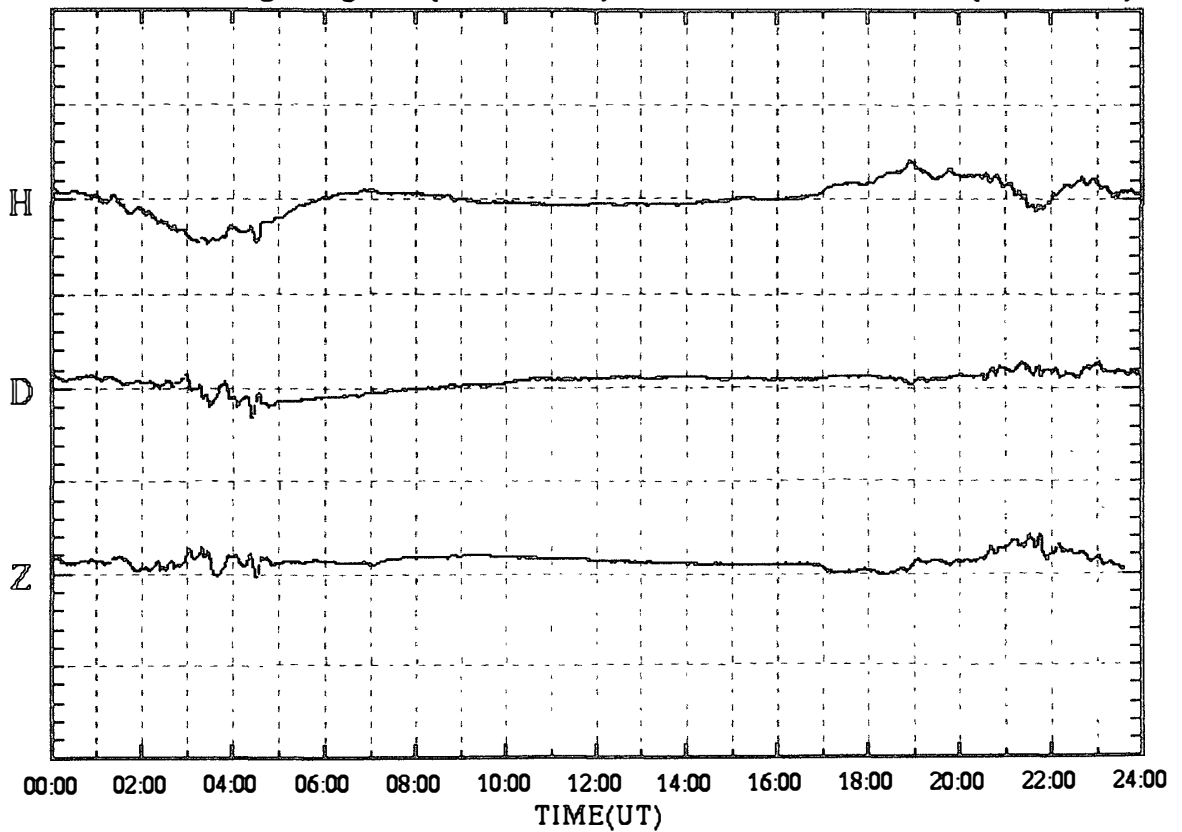

SYOWA magnetogram (100 nT/div)

11 Jan.2000 (DAY:011)

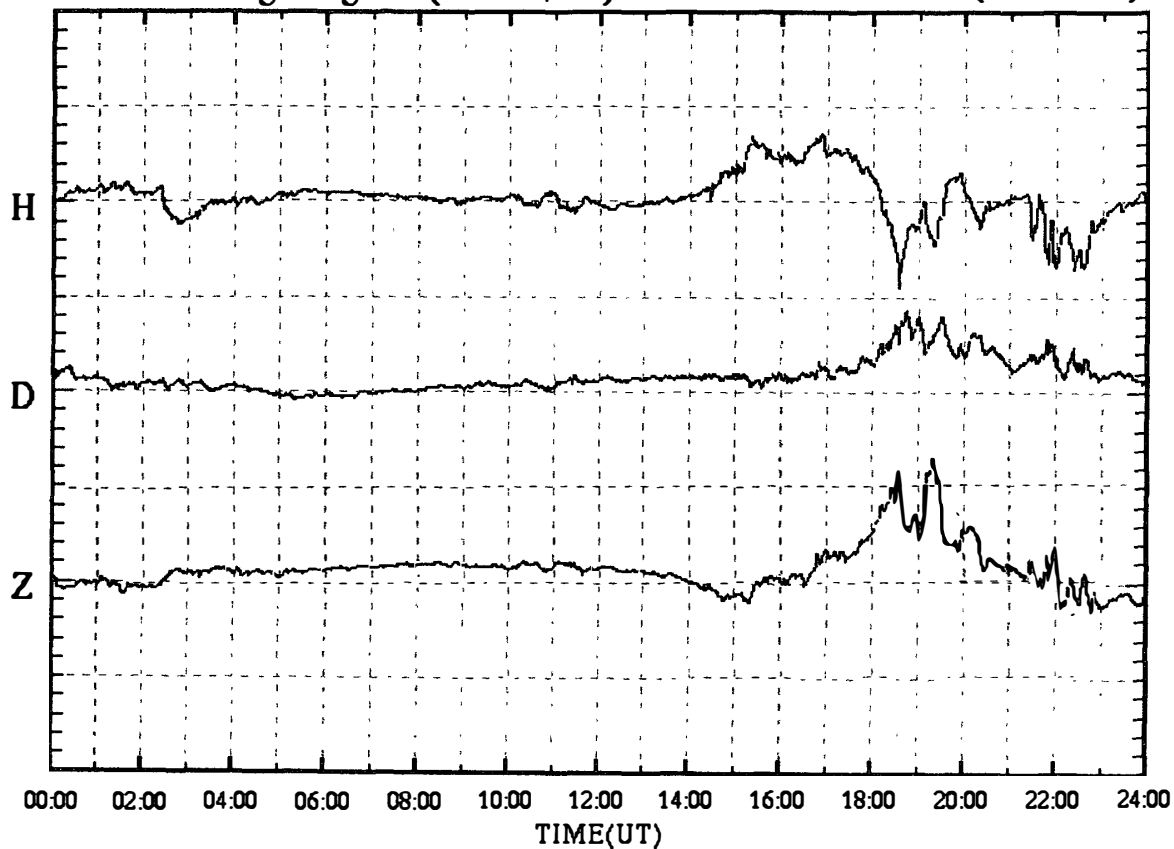

SYOWA magnetogram (100 nT/div)

12 Jan.2000 (DAY:012)

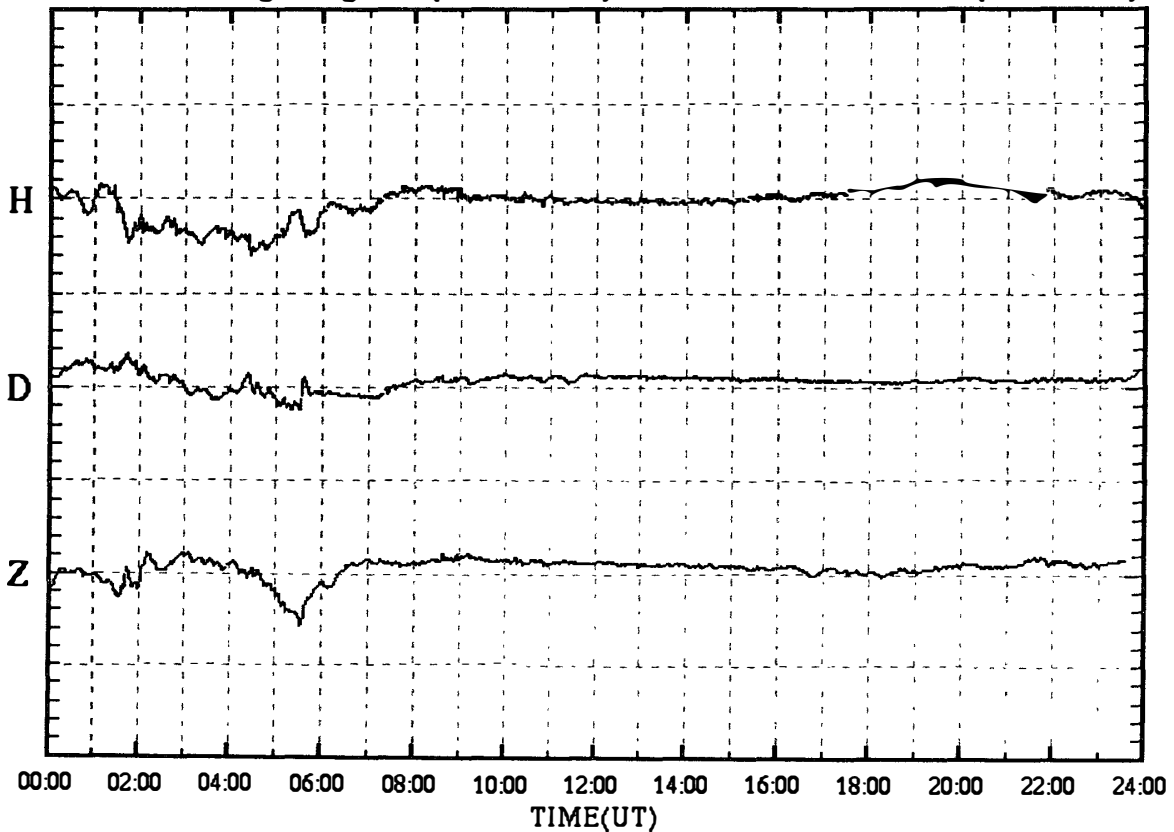

SYOWA magnetogram (100 nT/div)

13 Jan.2000 (DAY:013)

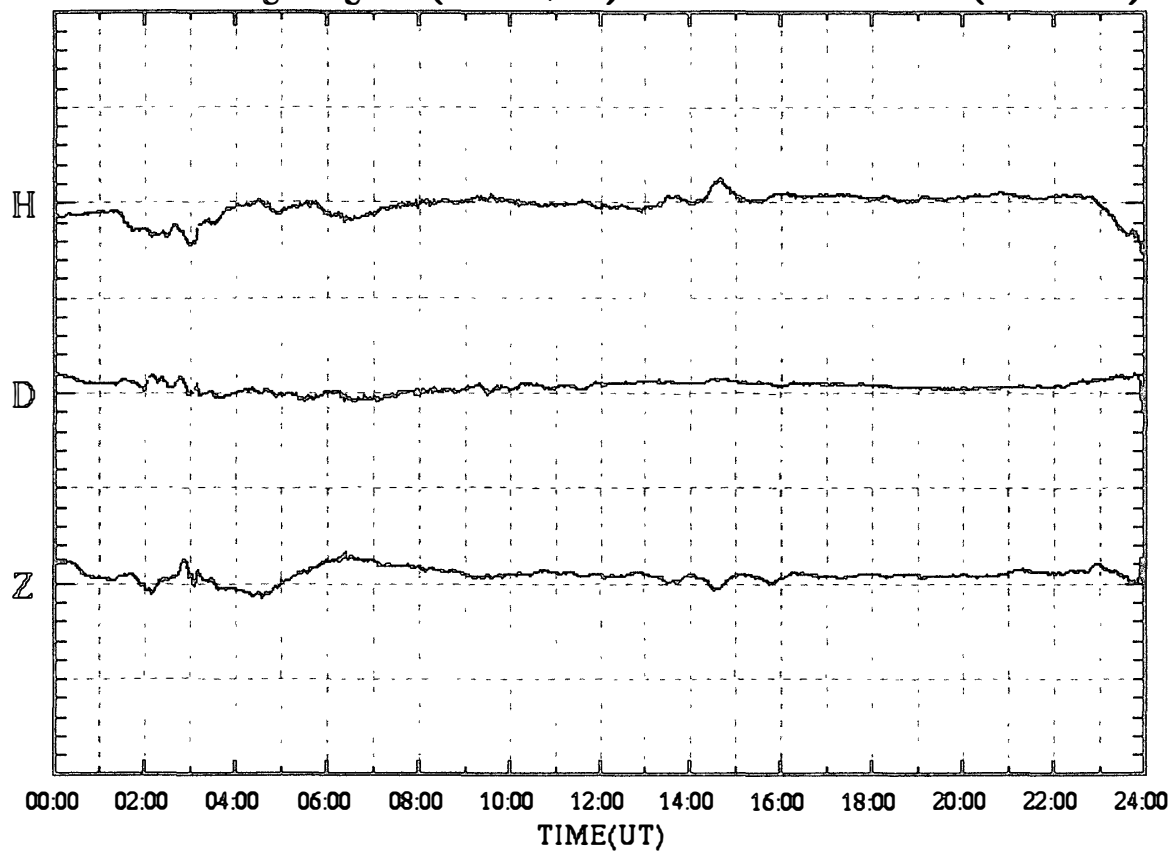

SYOWA magnetogram (100 nT/div)

14 Jan.2000 (DAY:014)

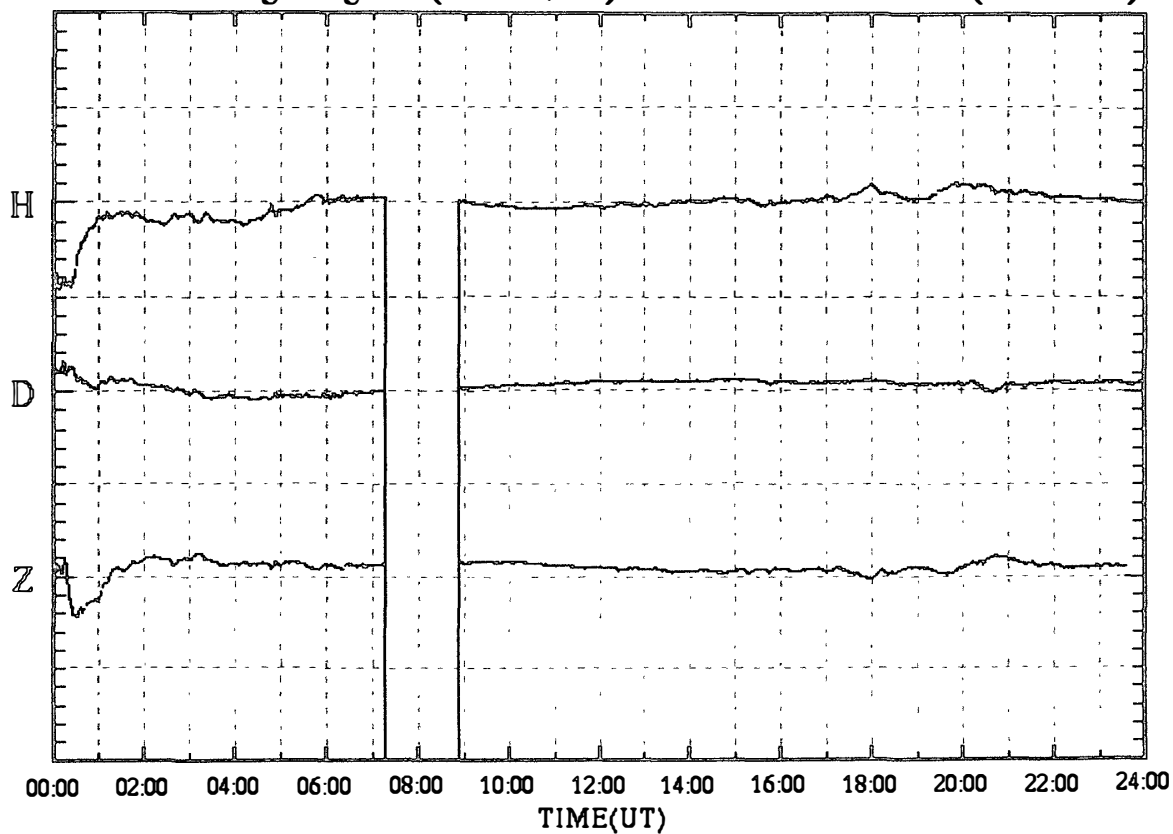

SYOWA magnetogram (100 nT/div)

15 Jan.2000 (DAY:015)

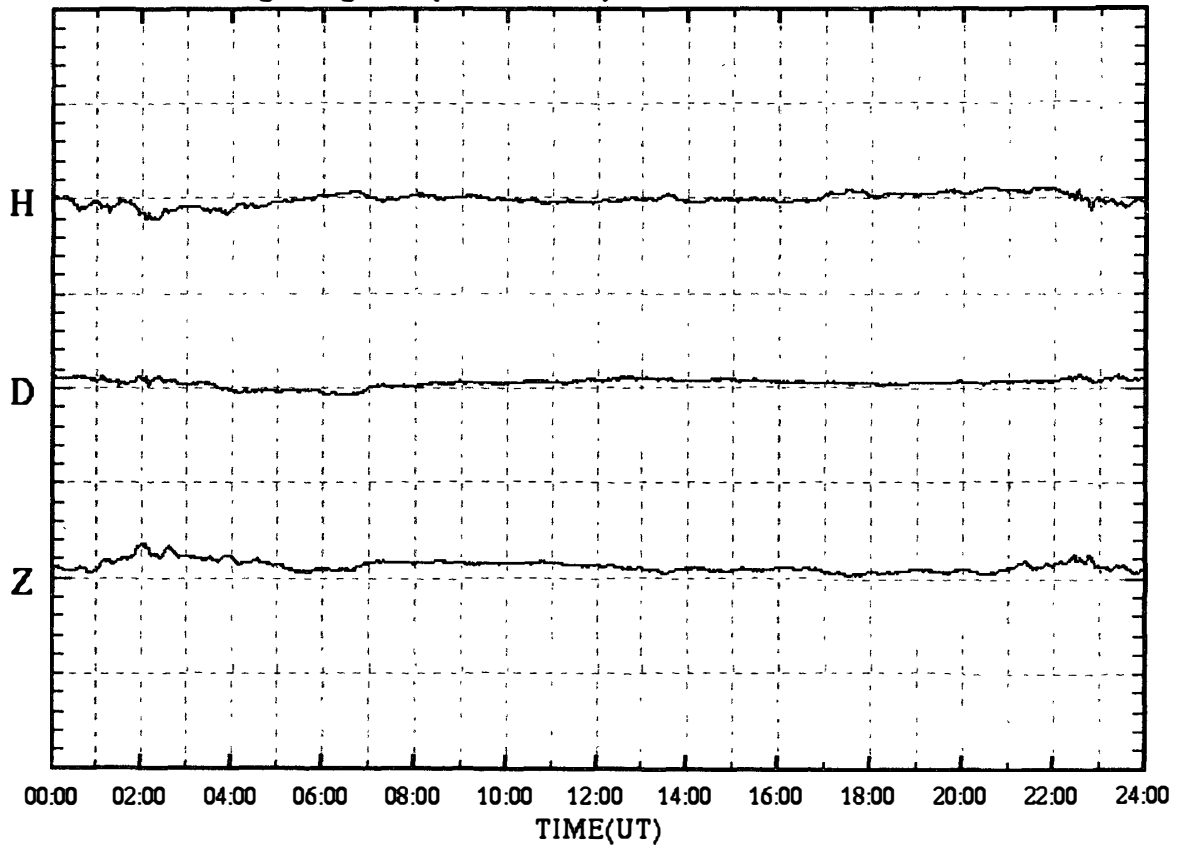

SYOWA magnetogram (100 nT/div)

16 Jan.2000 (DAY:016)

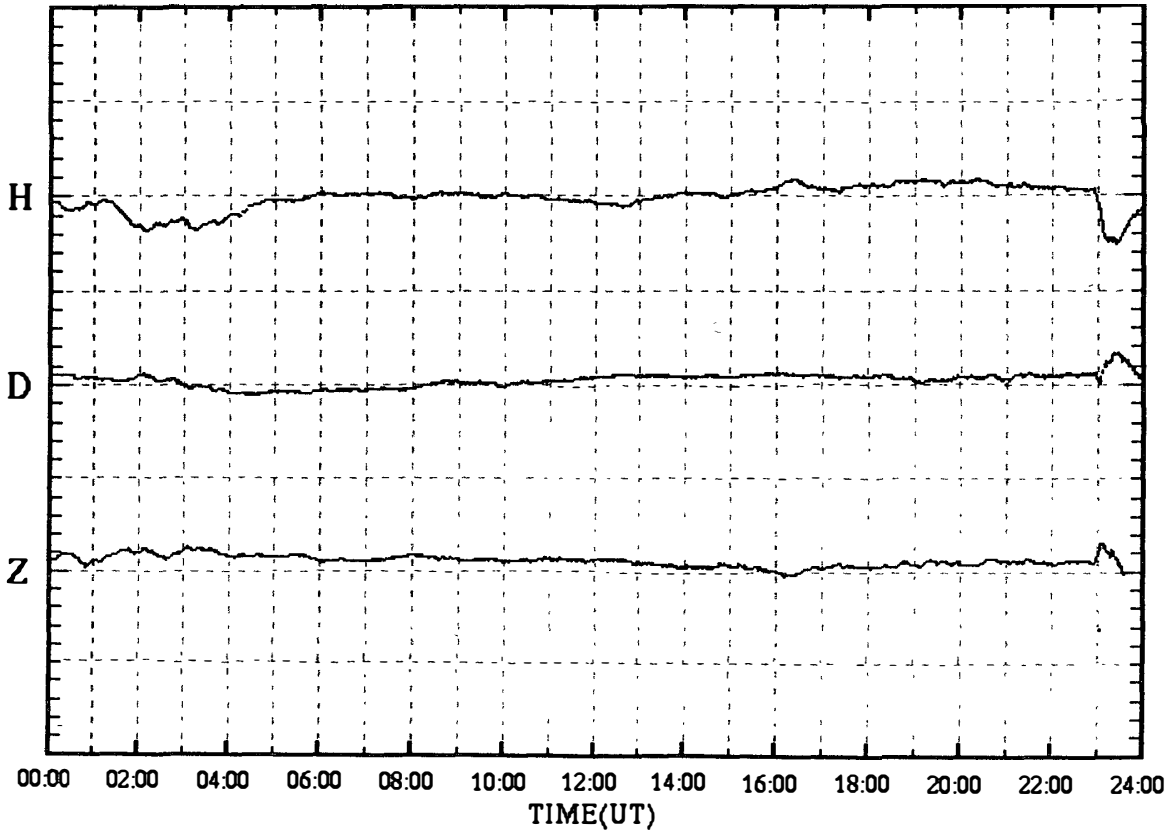

SYOWA magnetogram (100 nT/div)

17 Jan.2000 (DAY:017)

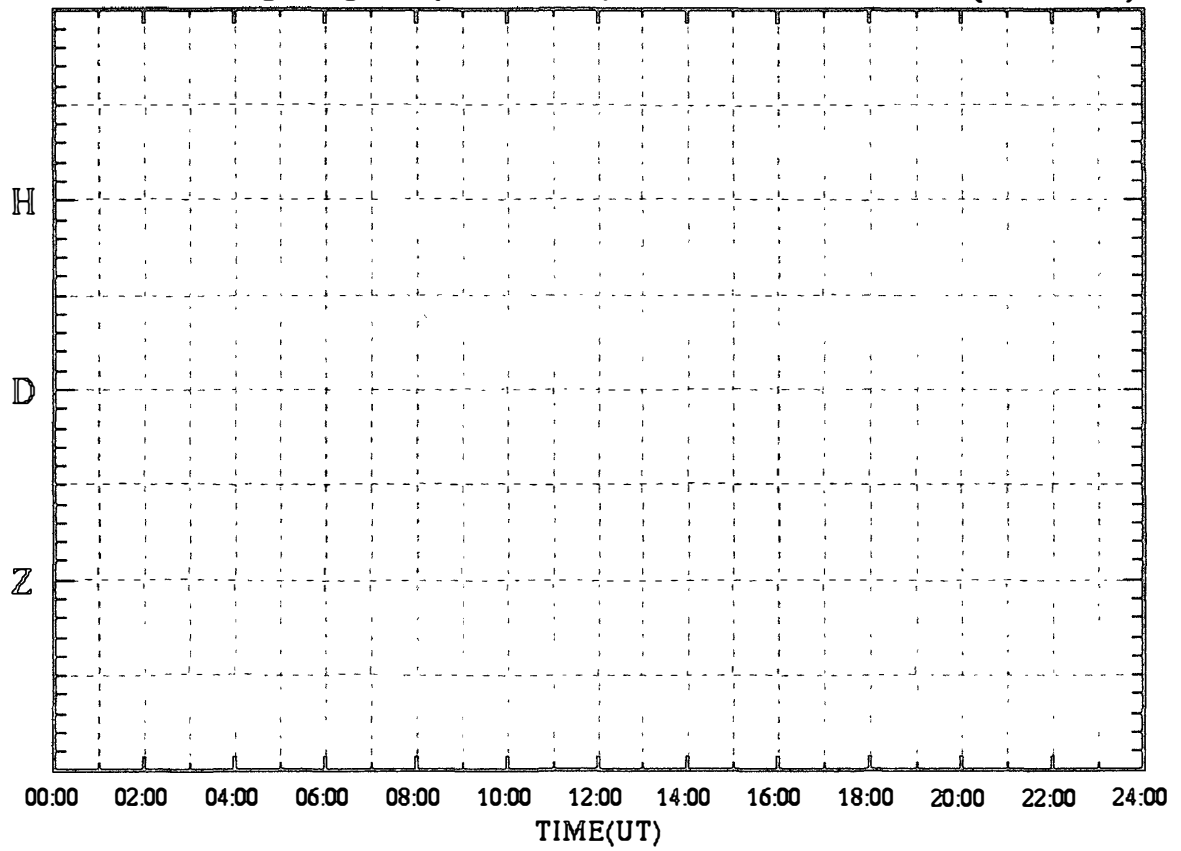

SYOWA magnetogram (100 nT/div)

18 Jan.2000 (DAY:018)

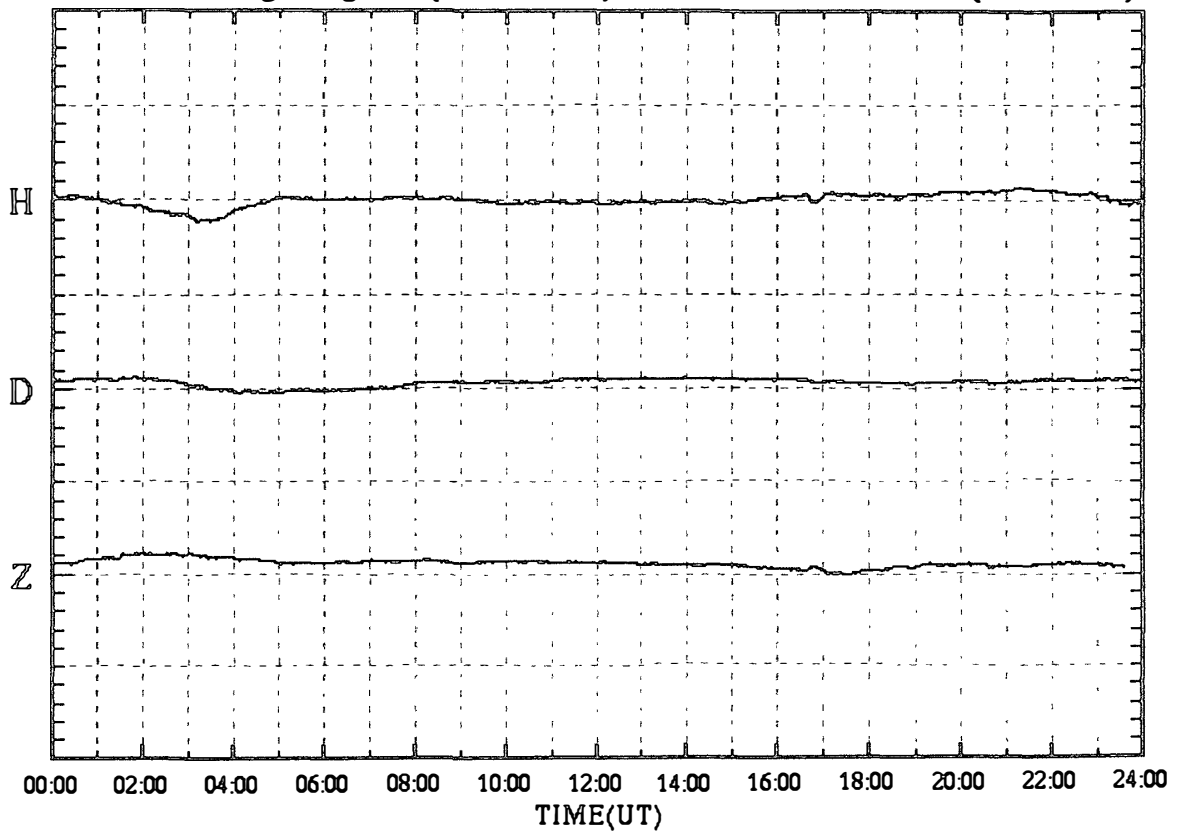

SYOWA magnetogram (100 nT/div)

19 Jan.2000 (DAY:019)

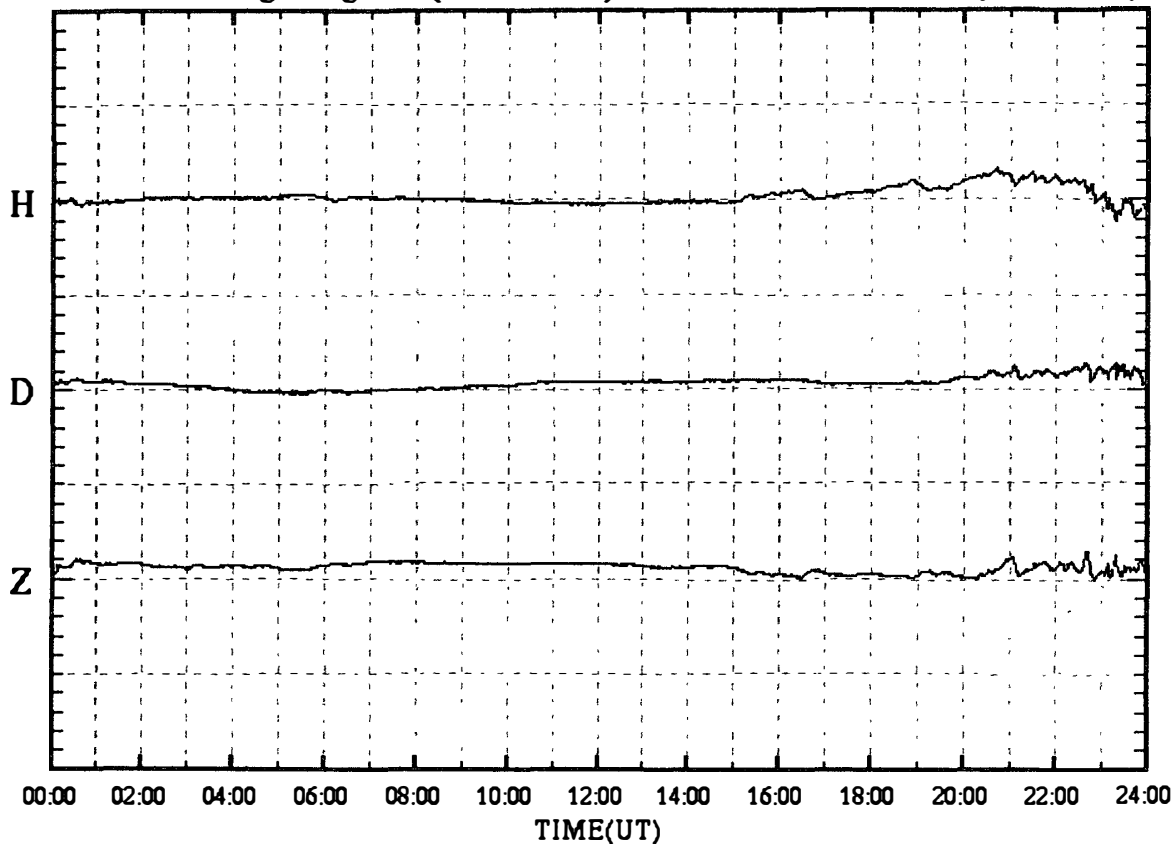

SYOWA magnetogram (100 nT/div)

20 Jan.2000 (DAY:020)

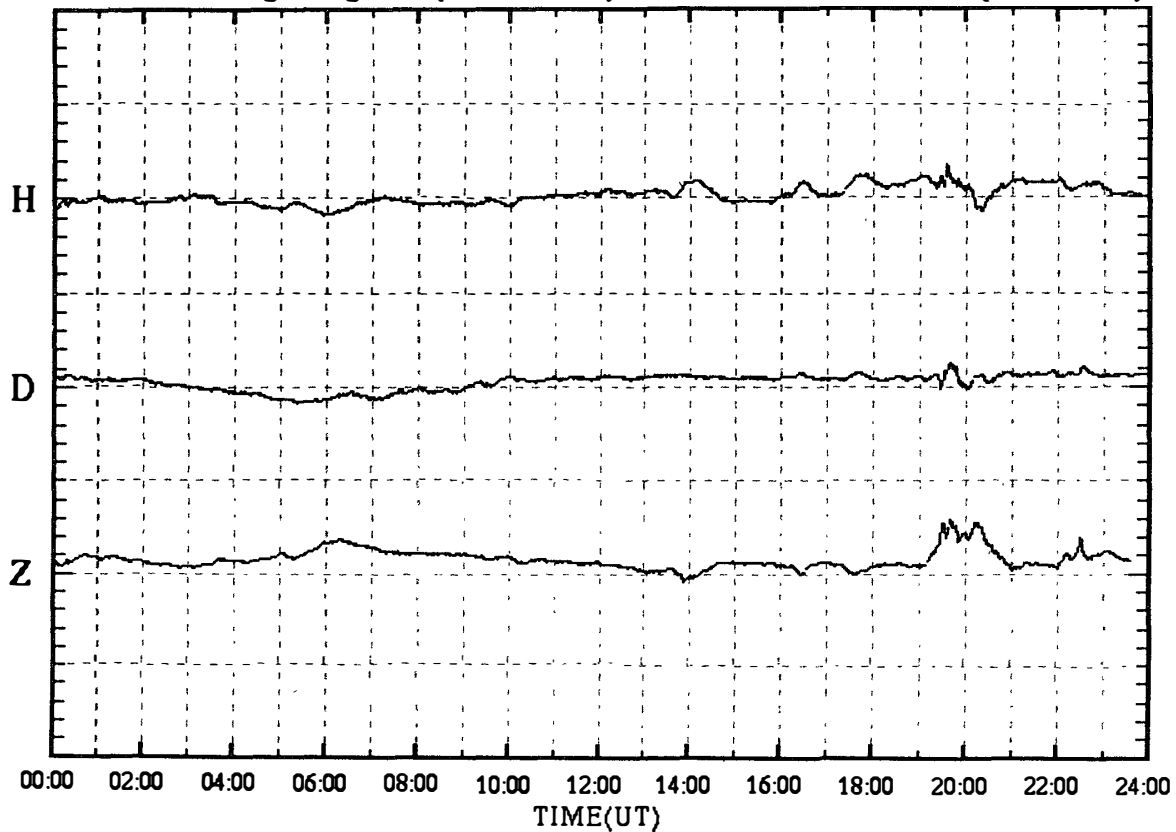

SYOWA magnetogram (100 nT/div)

21 Jan.2000 (DAY:021)

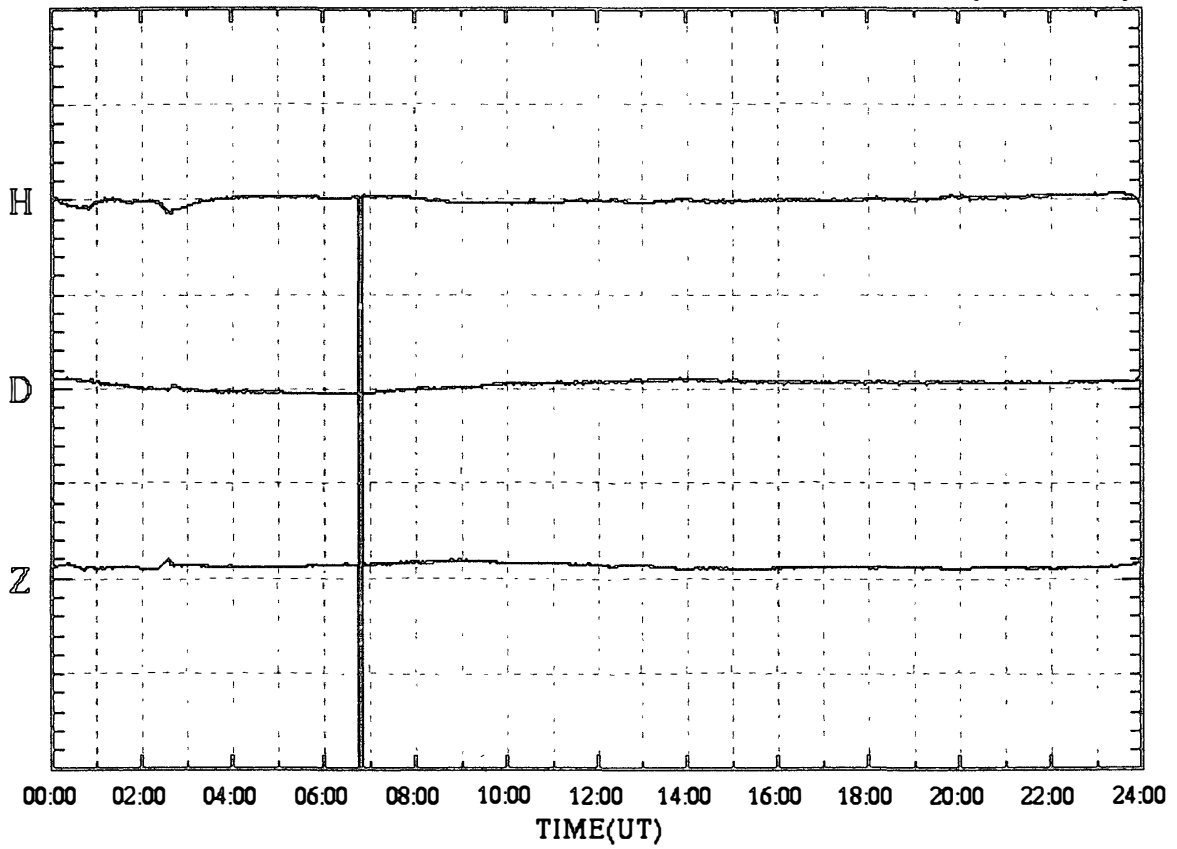

SYOWA magnetogram (100 nT/div)

22 Jan.2000 (DAY:022)

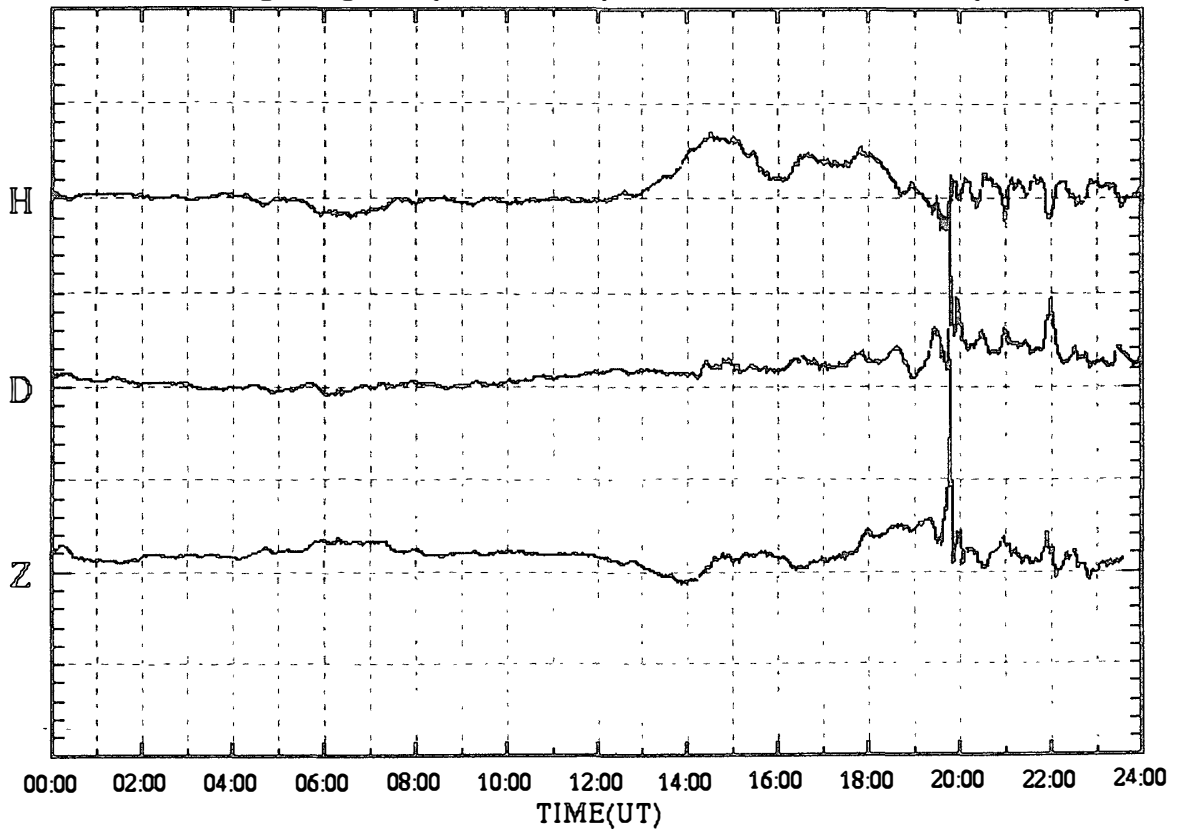

SYOWA magnetogram (100 nT/div)

23 Jan.2000 (DAY:023)

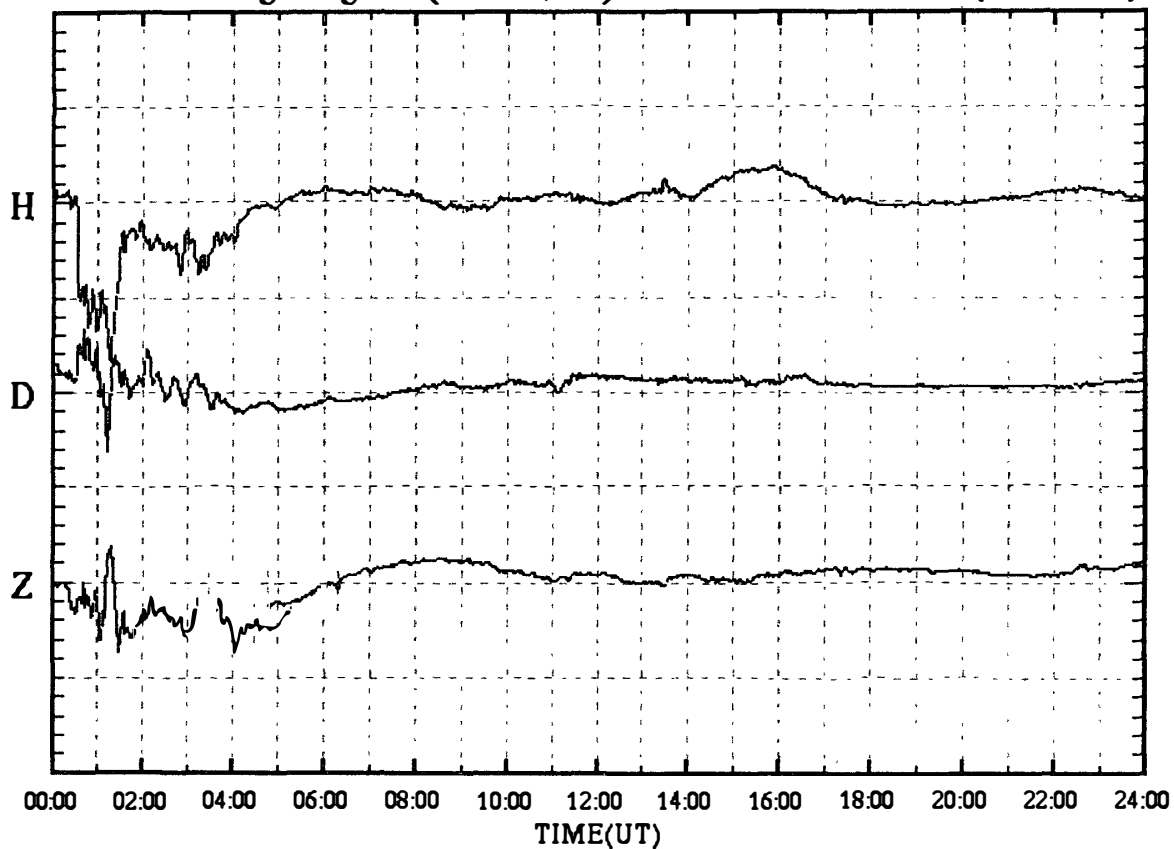

SYOWA magnetogram (100 nT/div)

24 Jan.2000 (DAY:024)

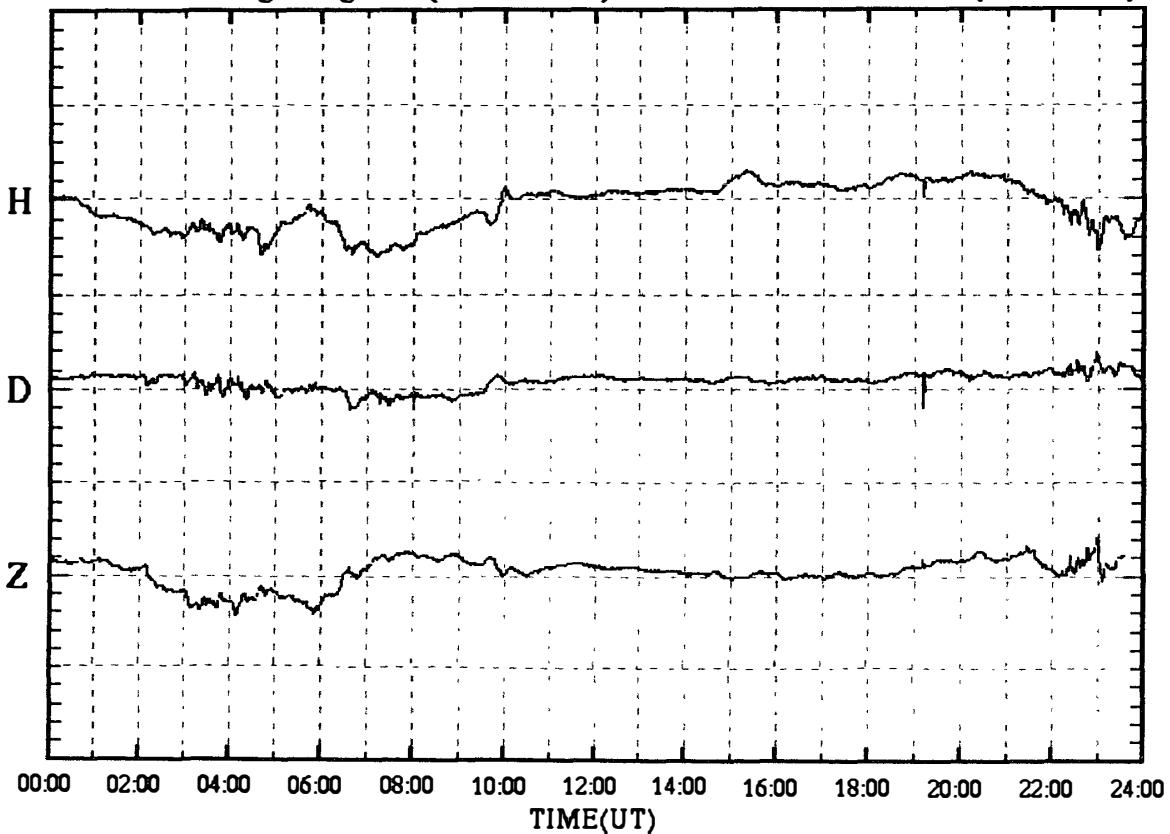

SYOWA magnetogram (100 nT/div)

25 Jan.2000 (DAY:025)

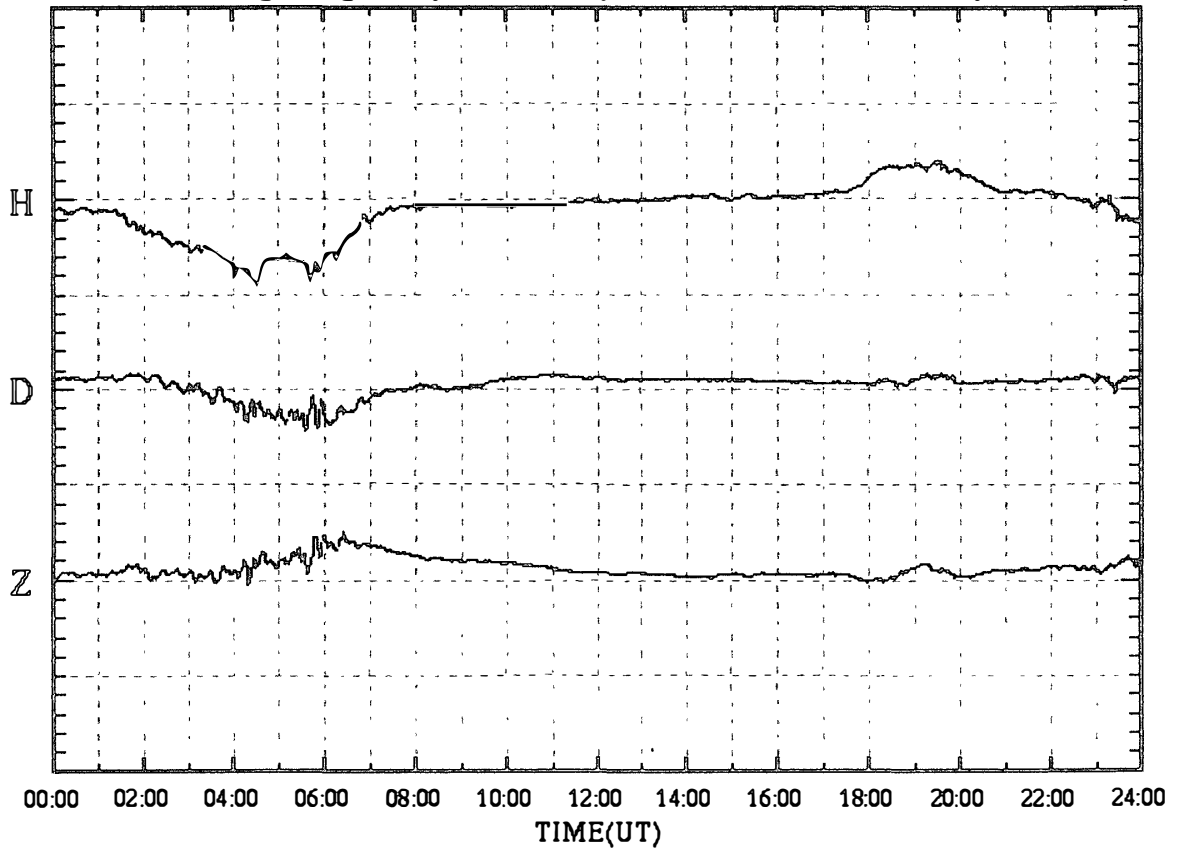

SYOWA magnetogram (100 nT/div)

26 Jan.2000 (DAY:026)

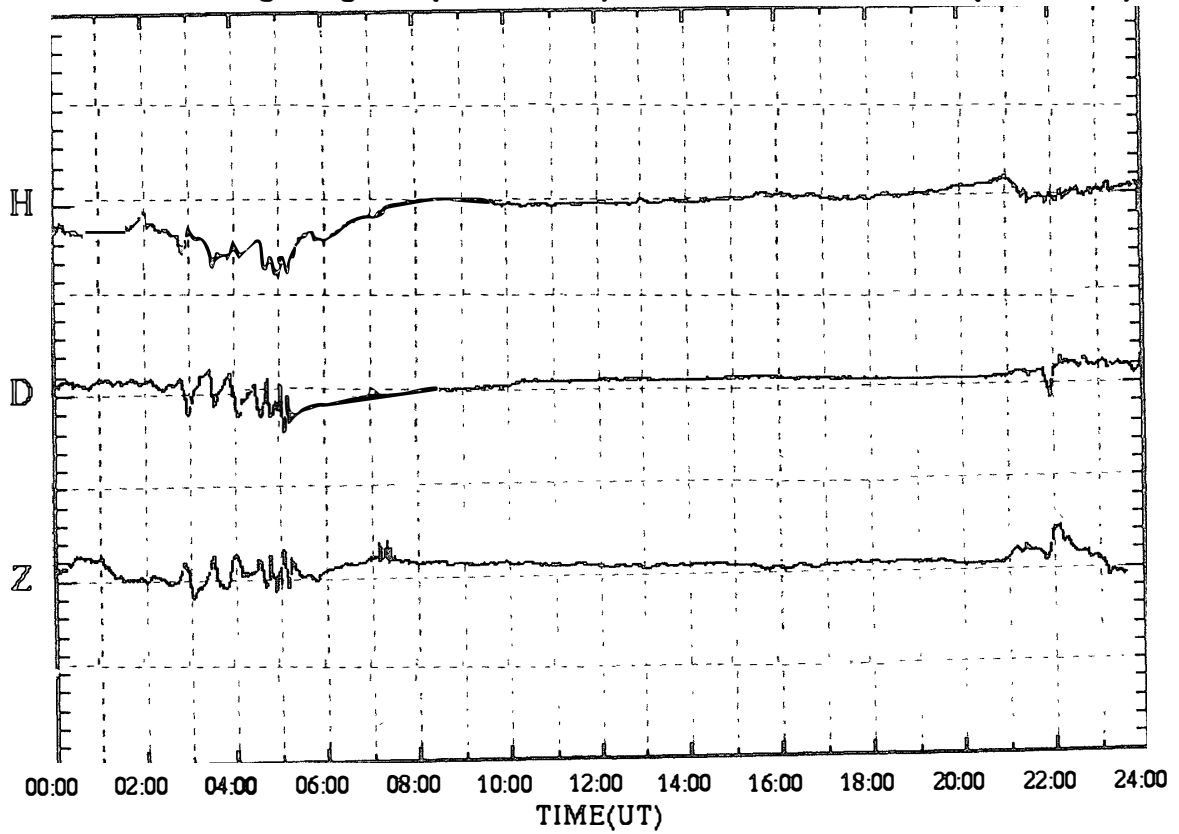

SYOWA magnetogram (100 nT/div)

27 Jan.2000 (DAY:027)

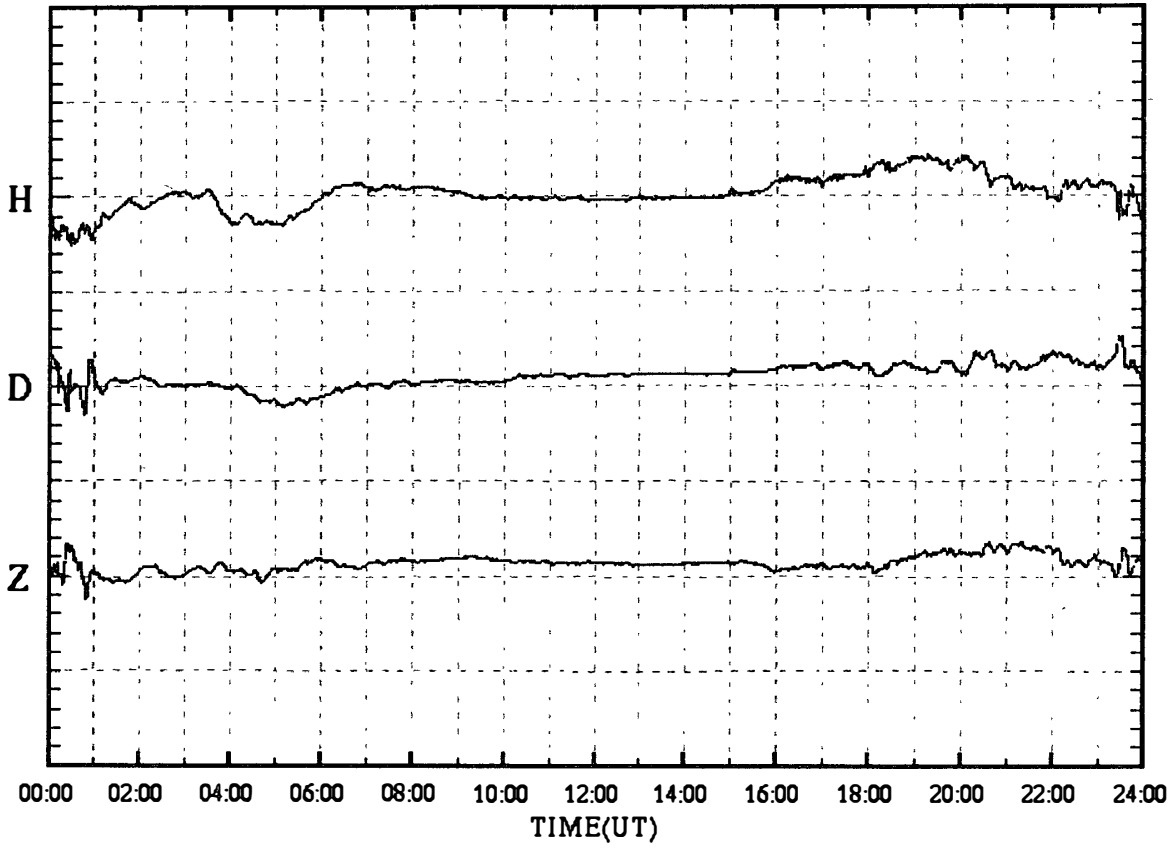

SYOWA magnetogram (100 nT/div)

28 Jan.2000 (DAY:028)

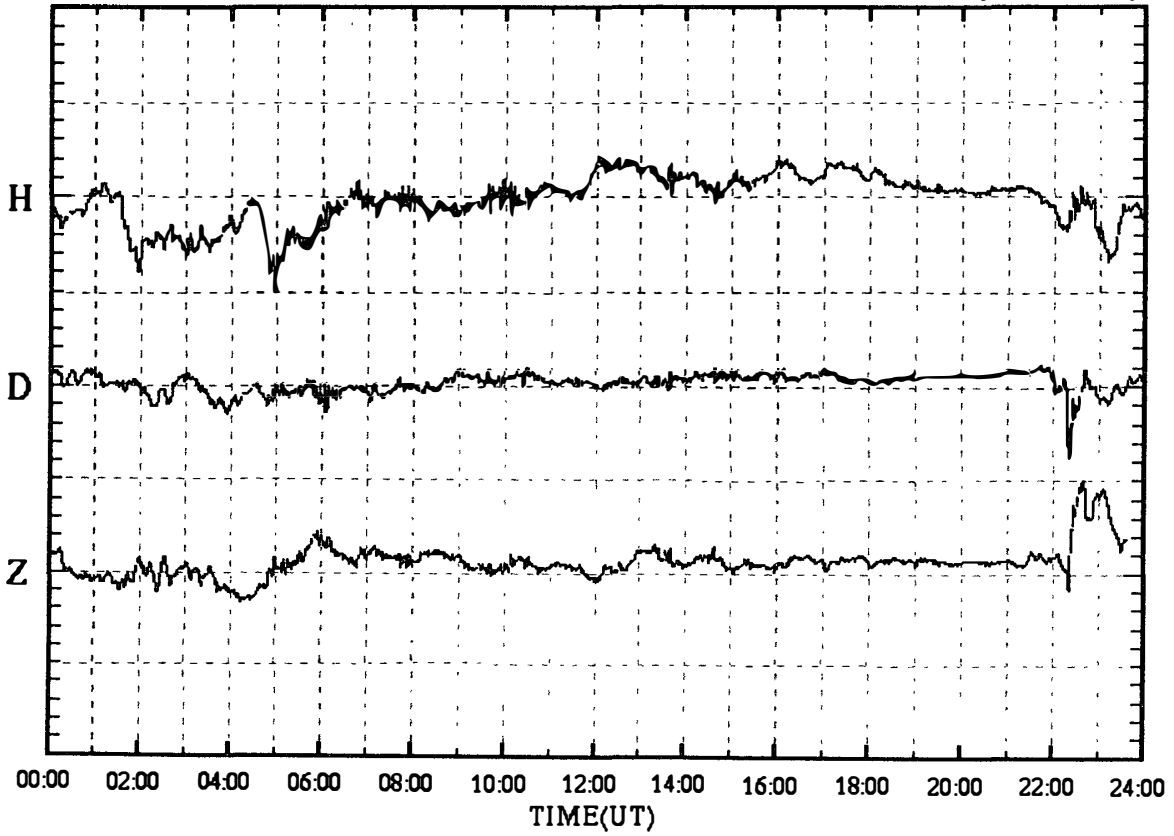

SYOWA magnetogram (100 nT/div)

29 Jan.2000 (DAY:029)

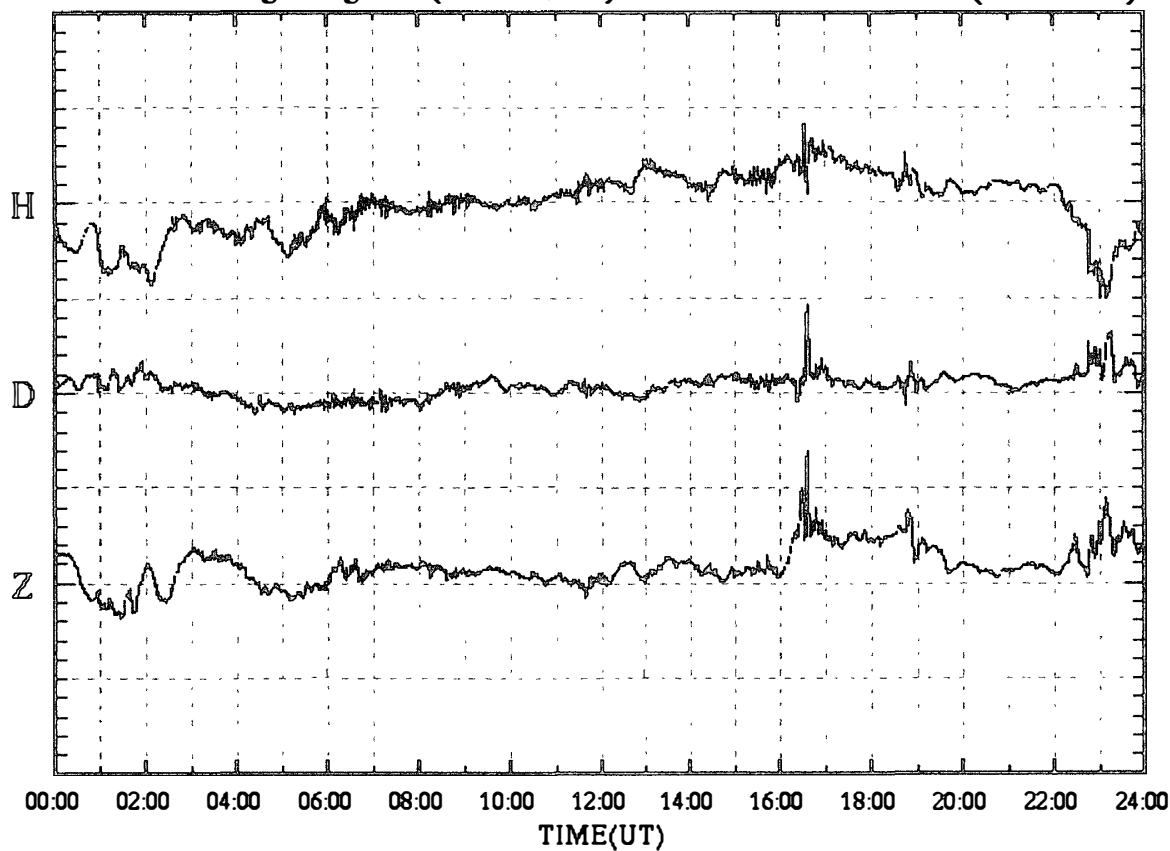

SYOWA magnetogram (100 nT/div)

30 Jan.2000 (DAY:030)

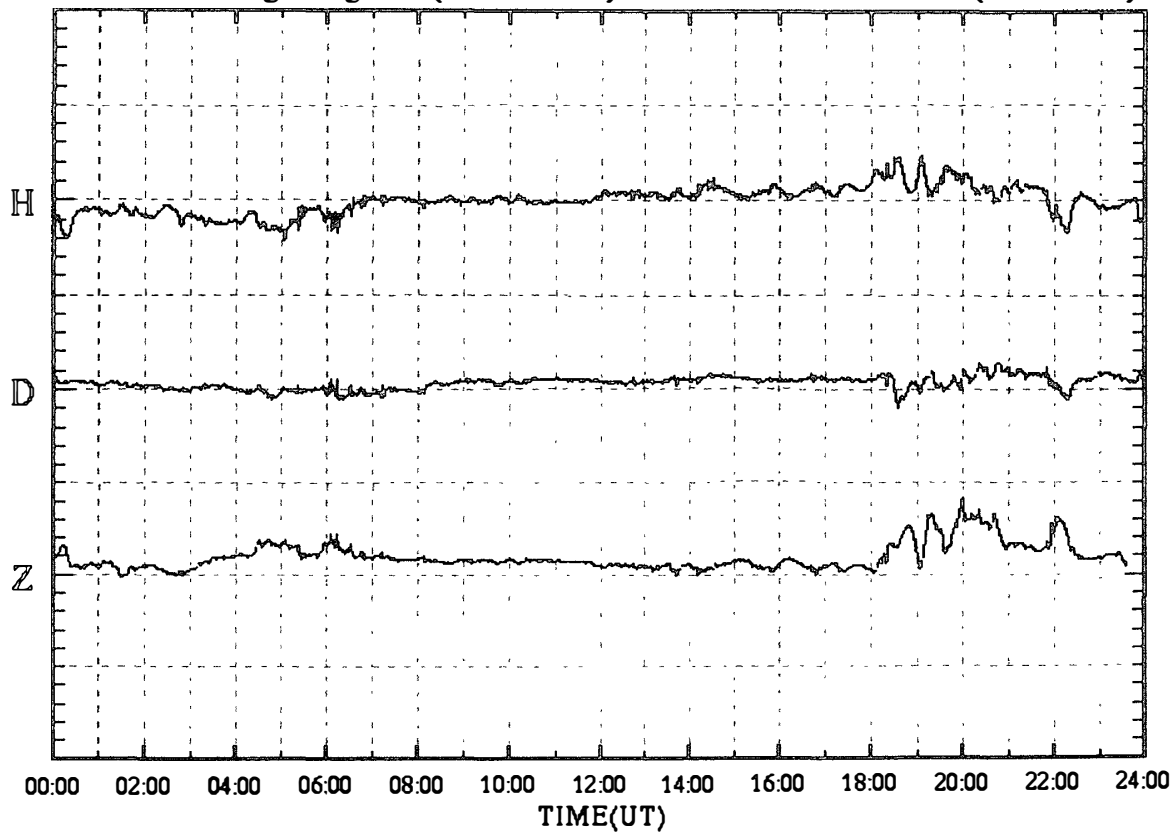

SYOWA magnetogram (100 nT/div)

31 Jan.2000 (DAY:031)

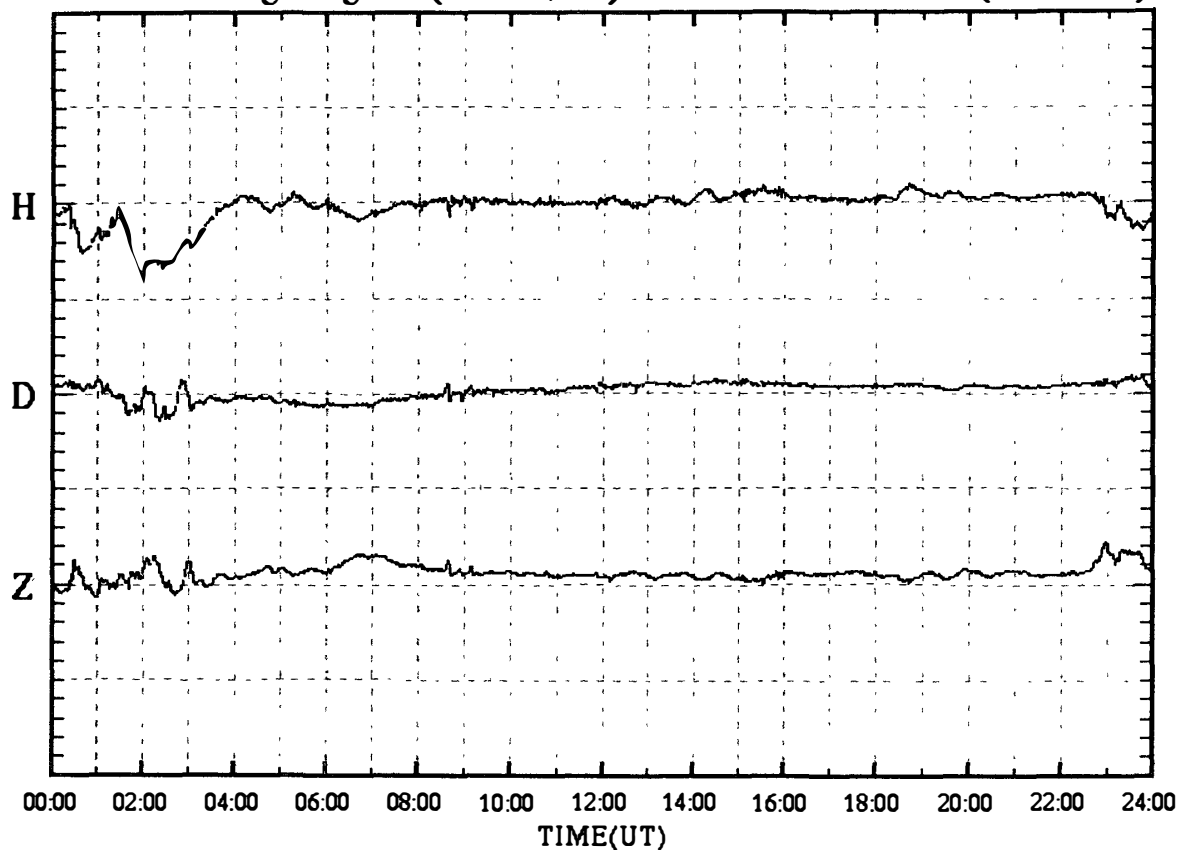

SYOWA magnetogram (100 nT/div)

01 Feb.2000 (DAY:032)

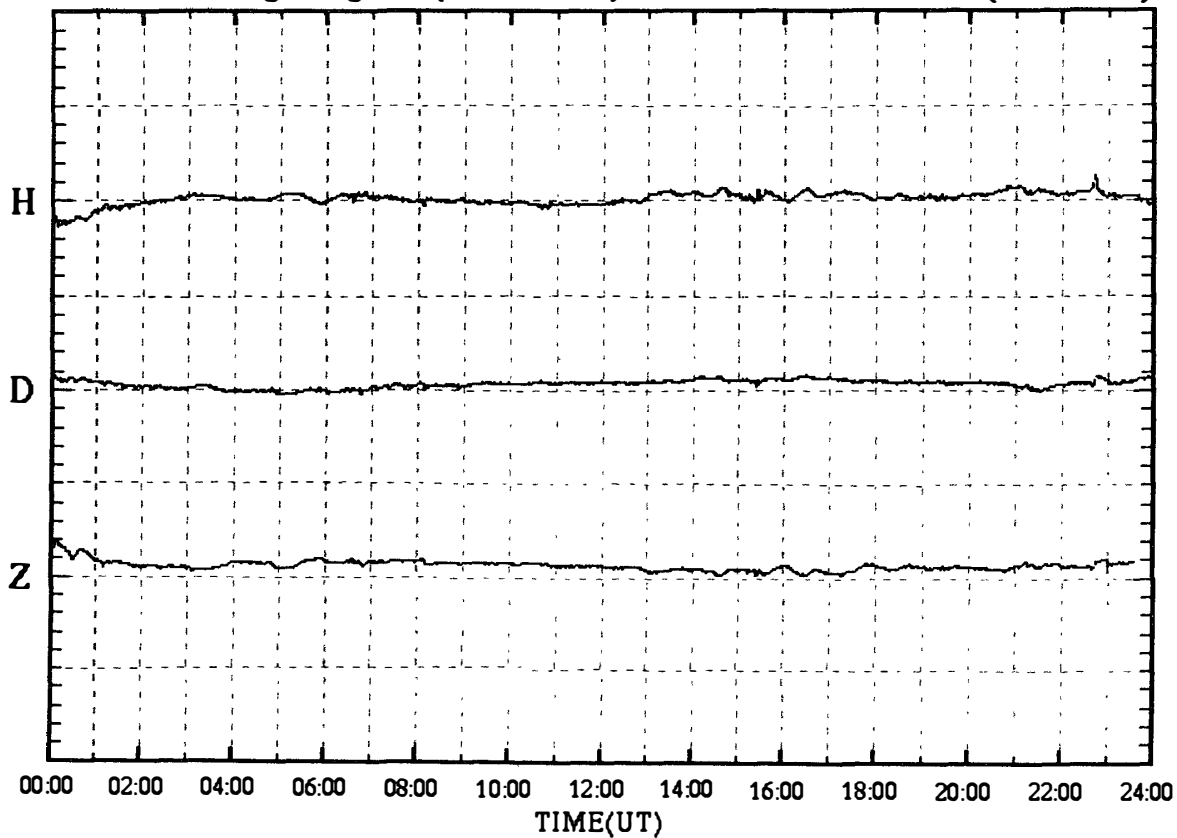

SYOWA magnetogram (100 nT/div)

02 Feb.2000 (DAY:033)

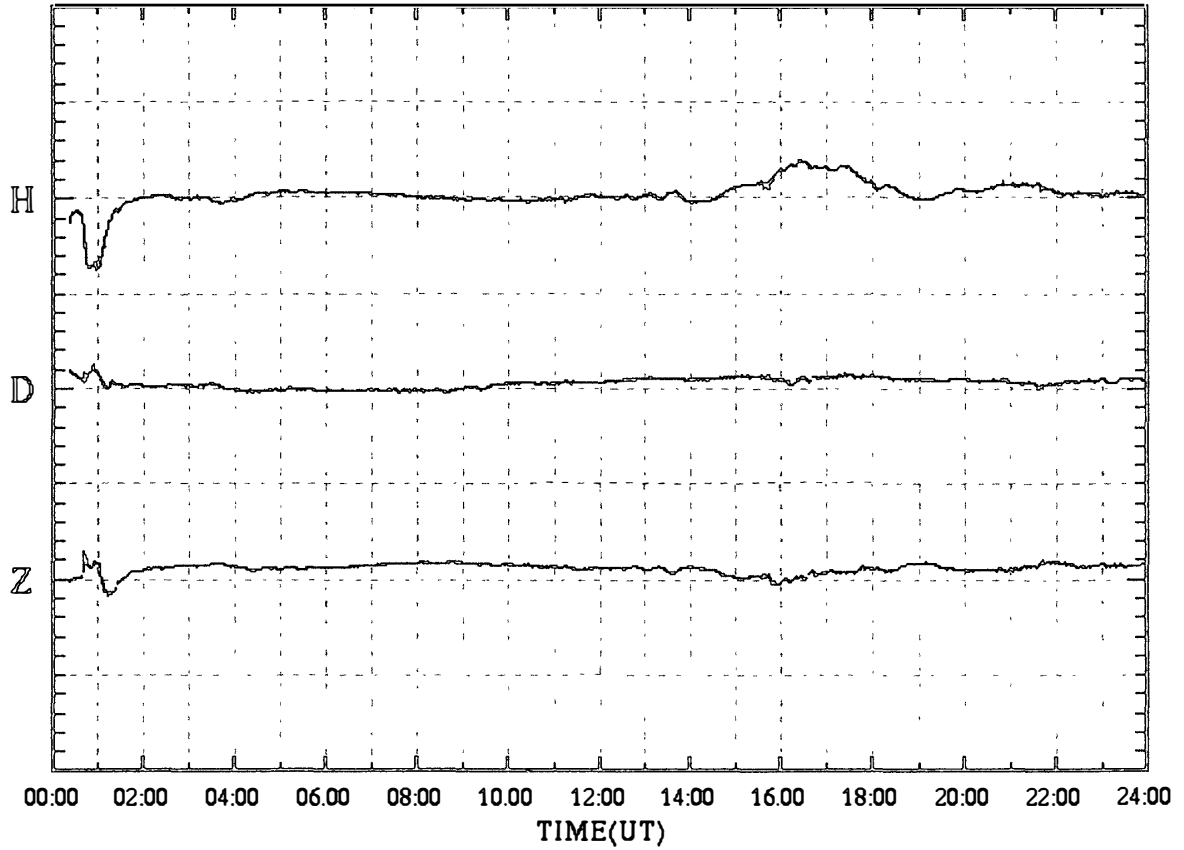

SYOWA magnetogram (100 nT/div)

03 Feb.2000 (DAY:034)

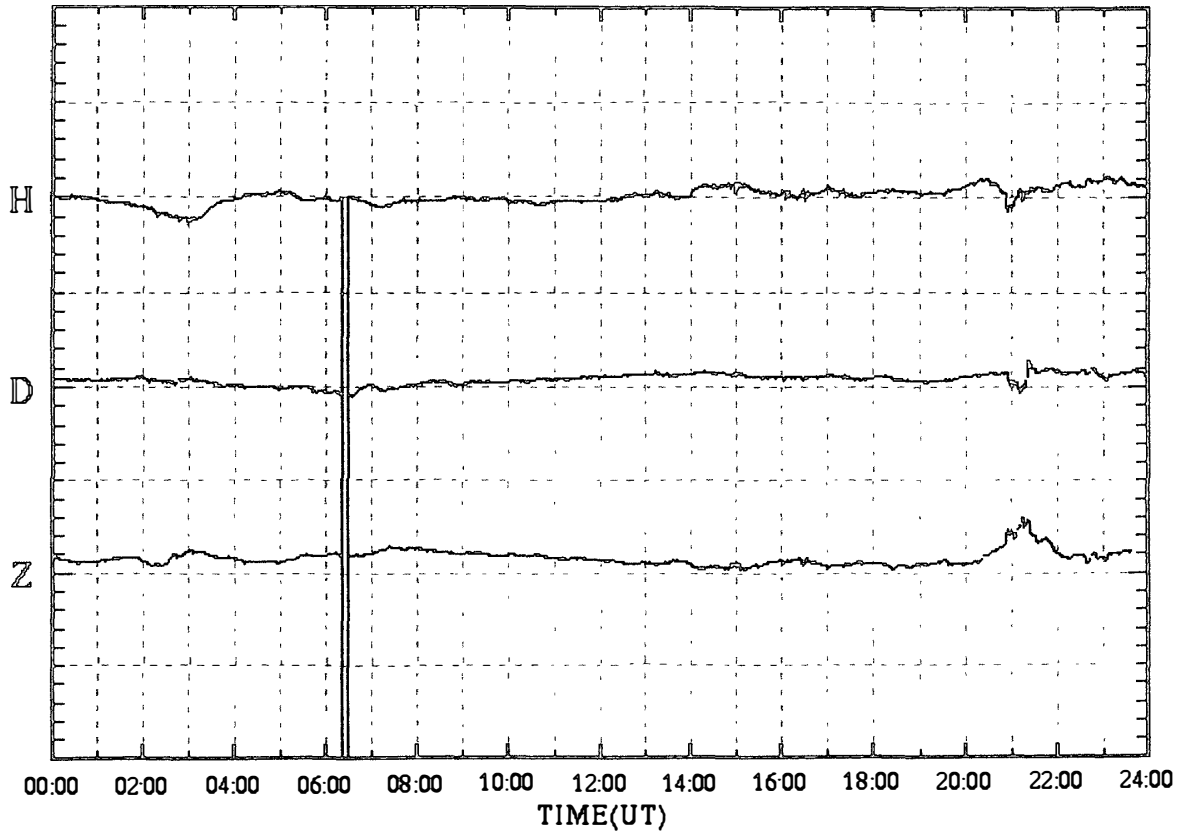

SYOWA magnetogram (100 nT/div)

04 Feb.2000 (DAY:035)

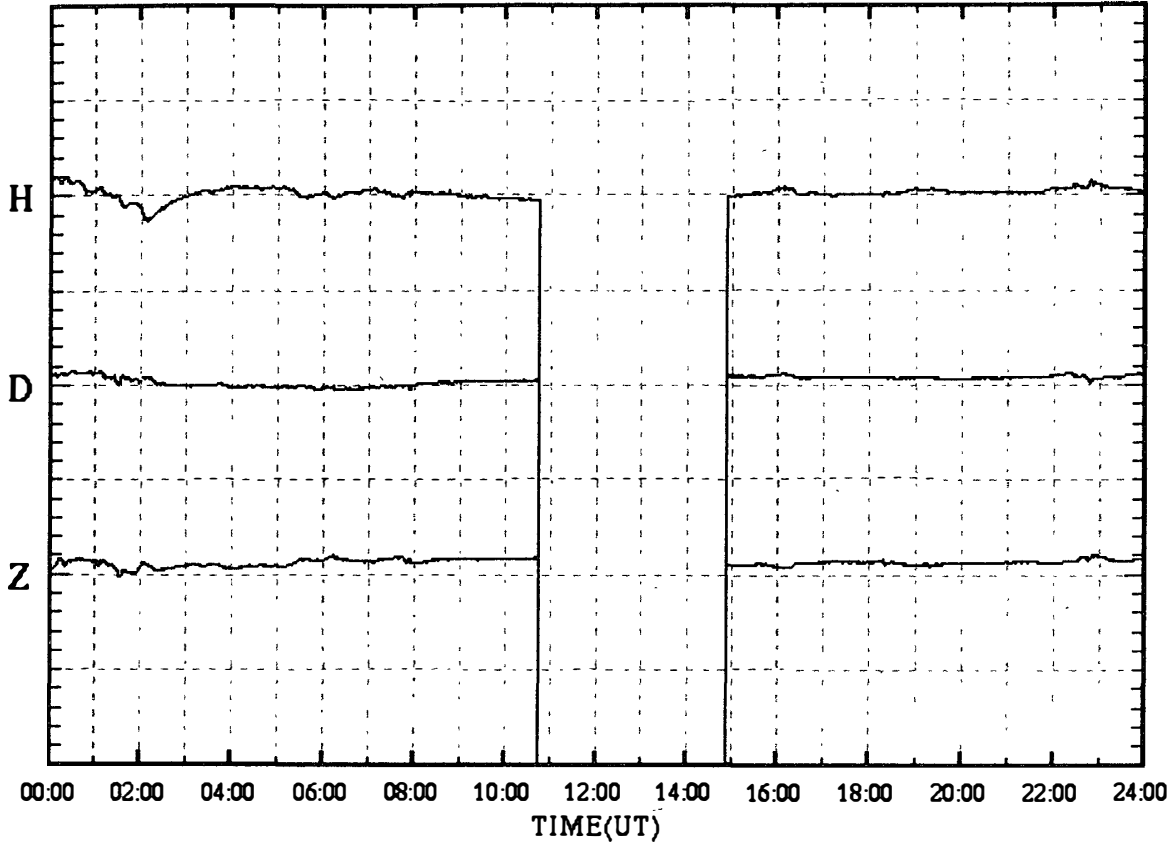

SYOWA magnetogram (100 nT/div)

05 Feb.2000 (DAY:036)

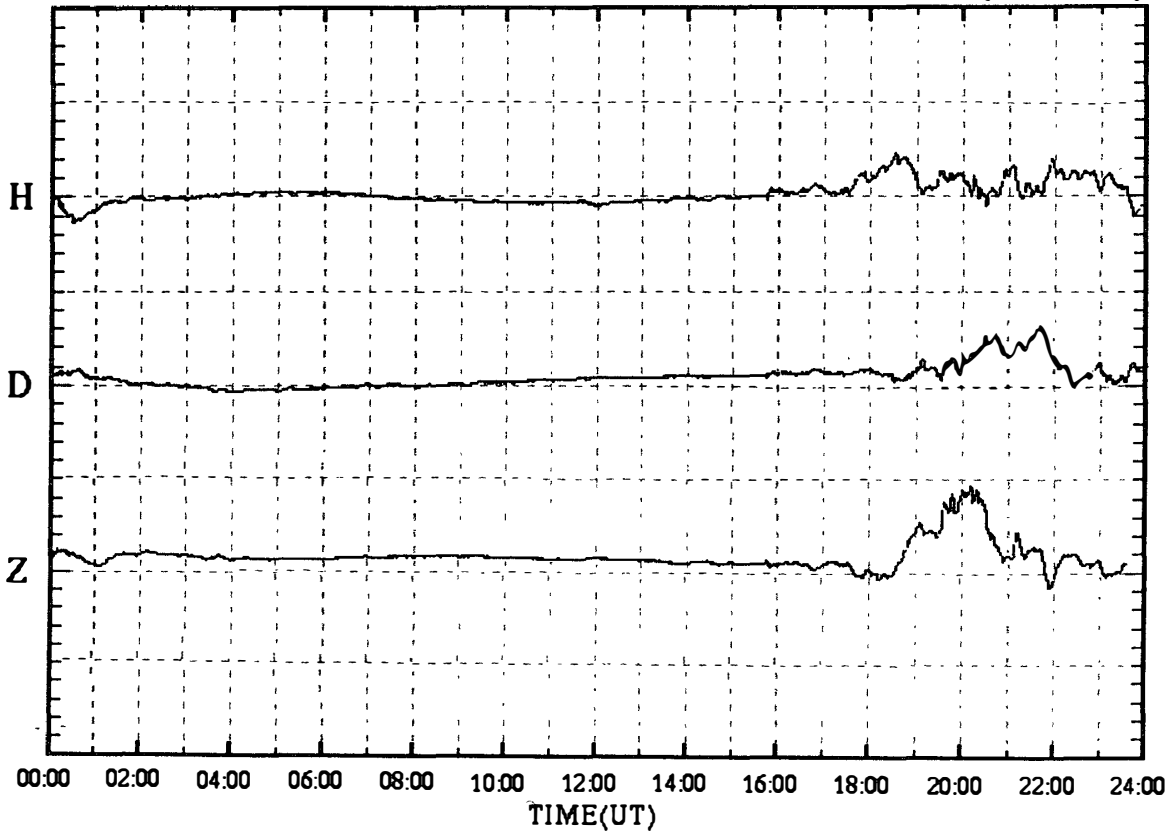

SYOWA magnetogram (100 nT/div)

06 Feb.2000 (DAY:037)

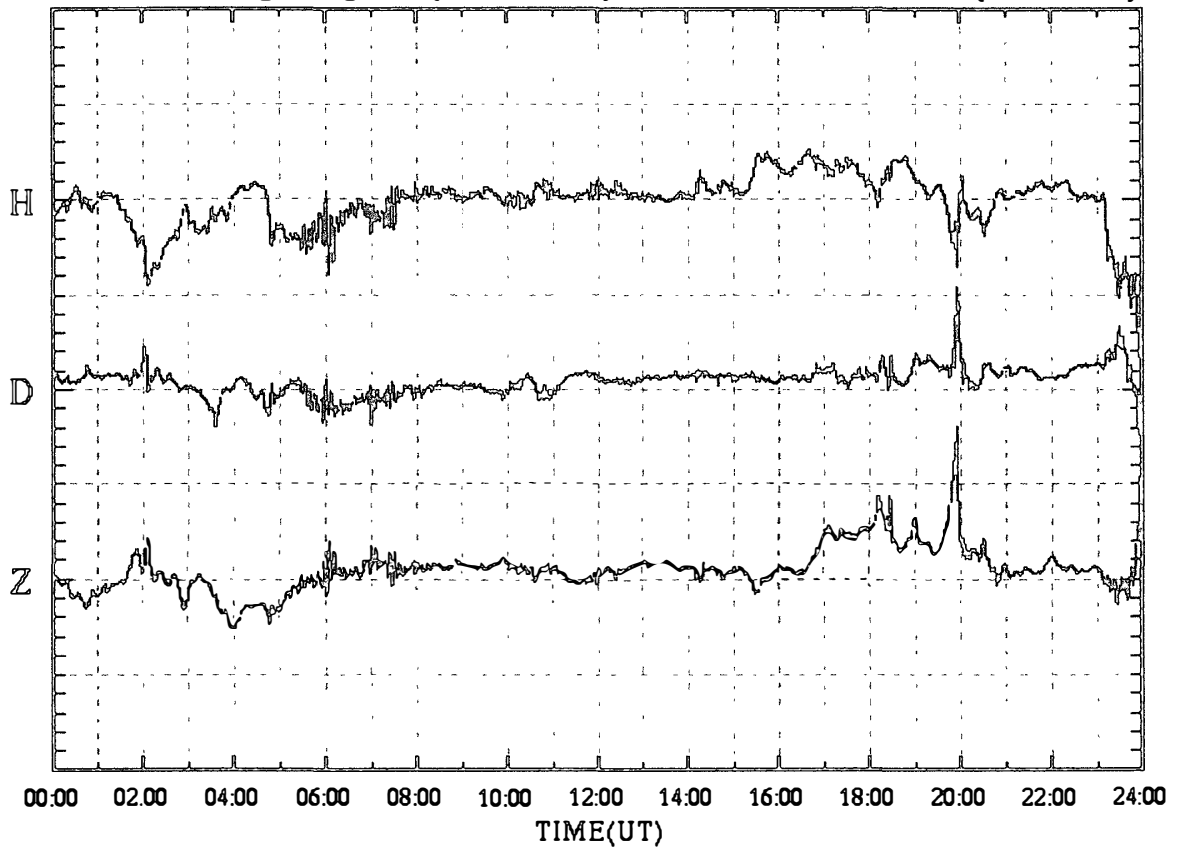

SYOWA magnetogram (100 nT/div)

07 Feb.2000 (DAY:038)

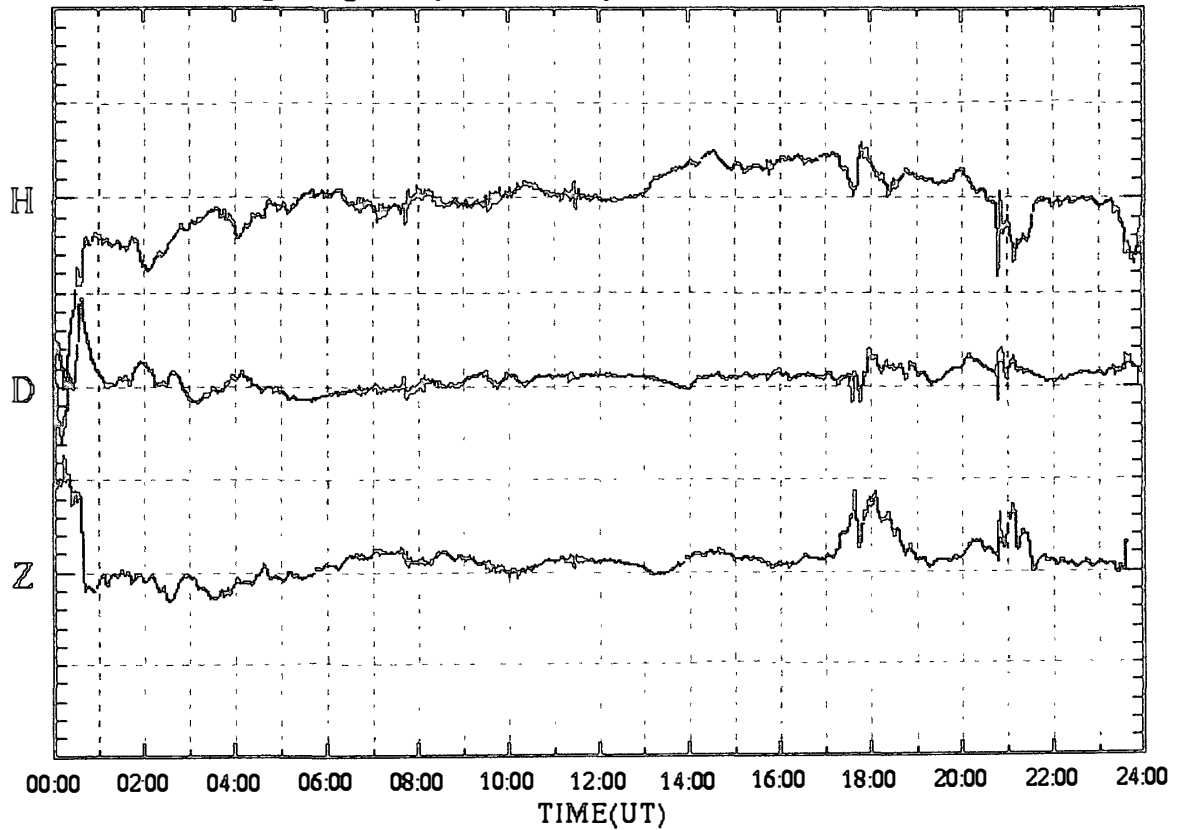

SYOWA magnetogram (100 nT/div)

08 Feb.2000 (DAY:039)

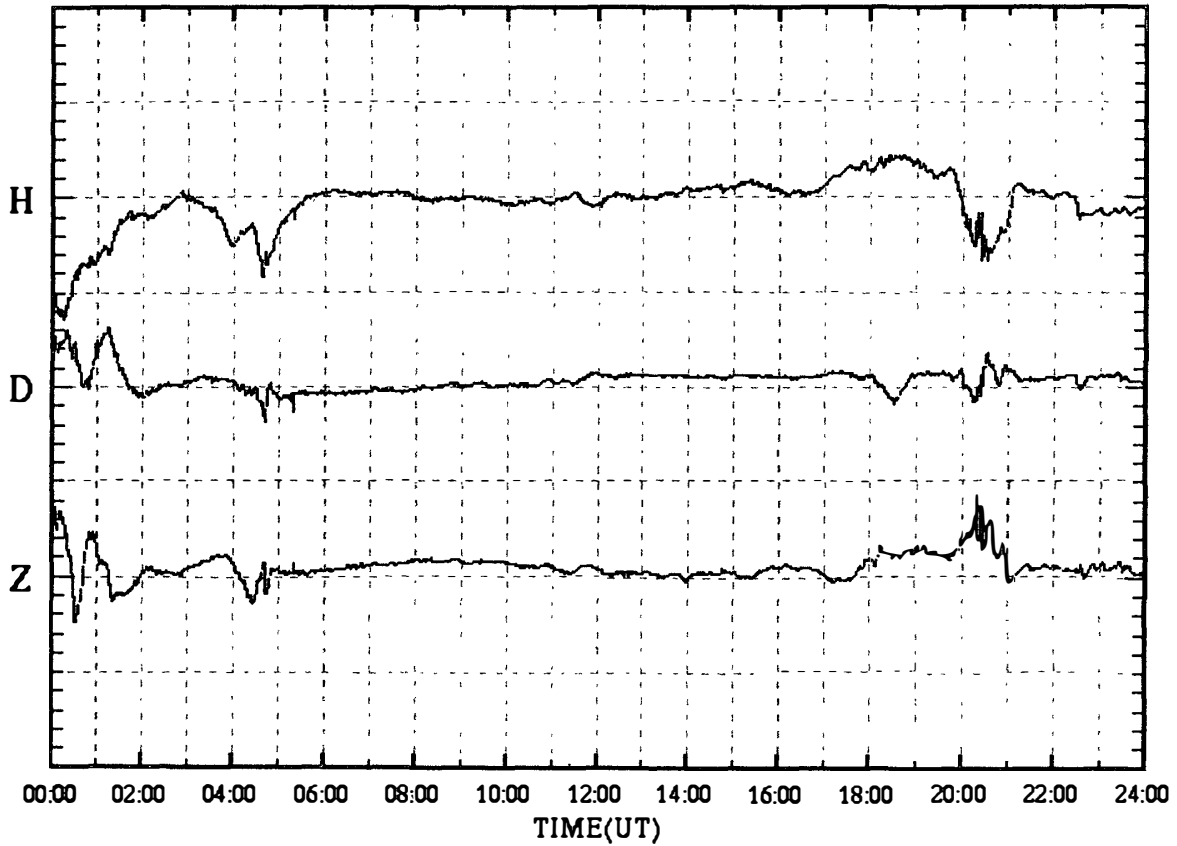

SYOWA magnetogram (100 nT/div)

09 Feb.2000 (DAY:040)

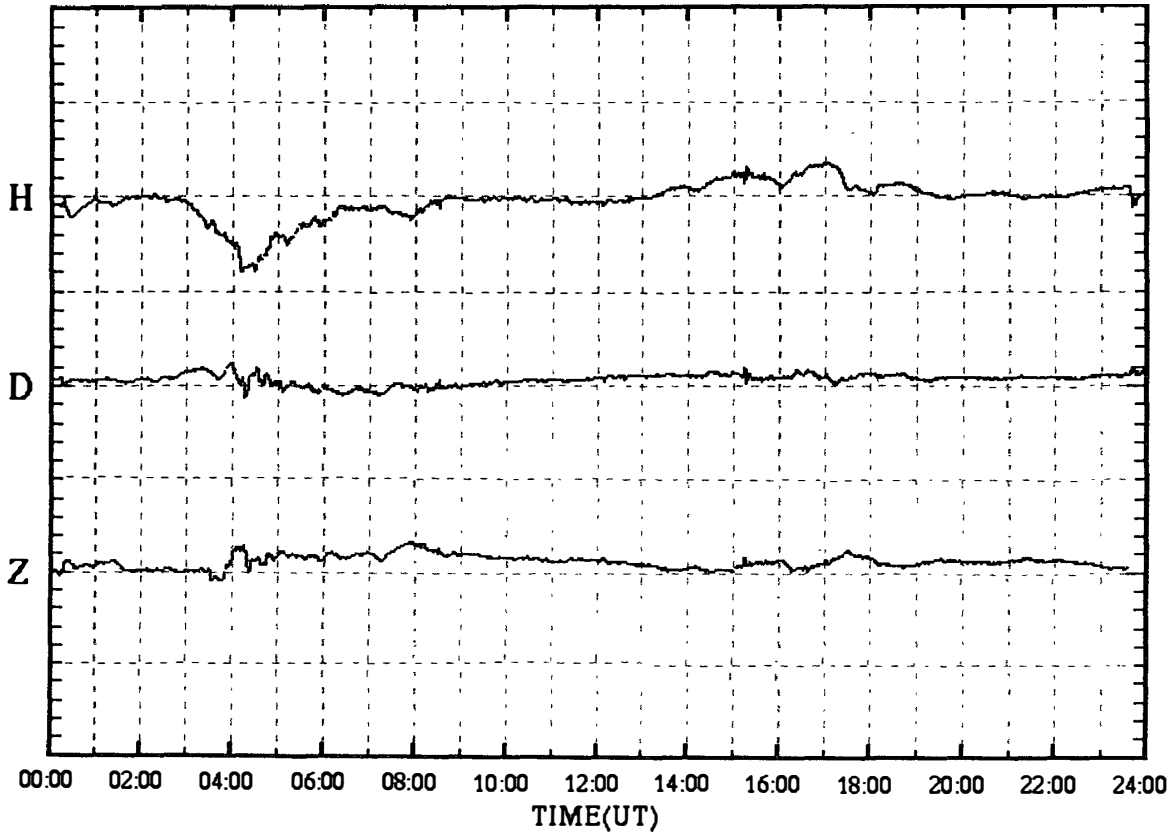

SYOWA magnetogram (100 nT/div)

10 Feb.2000 (DAY:041)

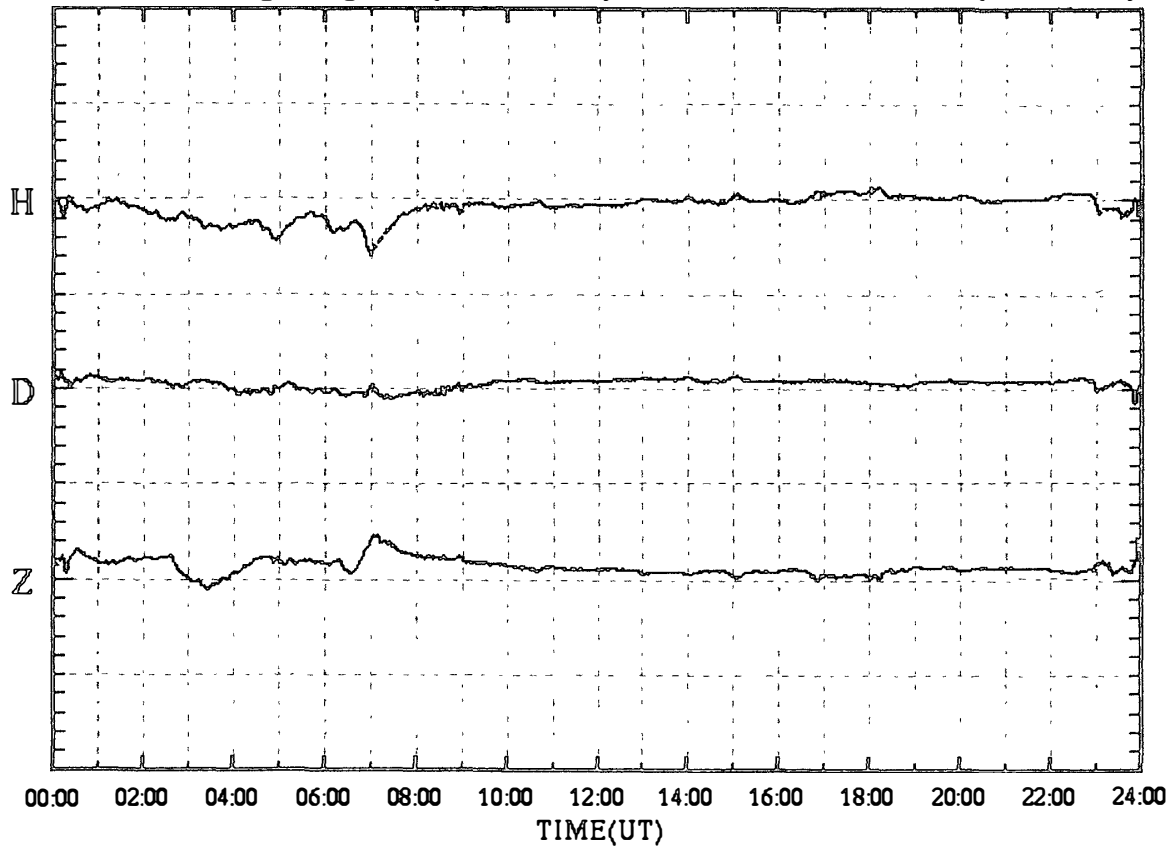

SYOWA magnetogram (100 nT/div)

11 Feb.2000 (DAY:042)

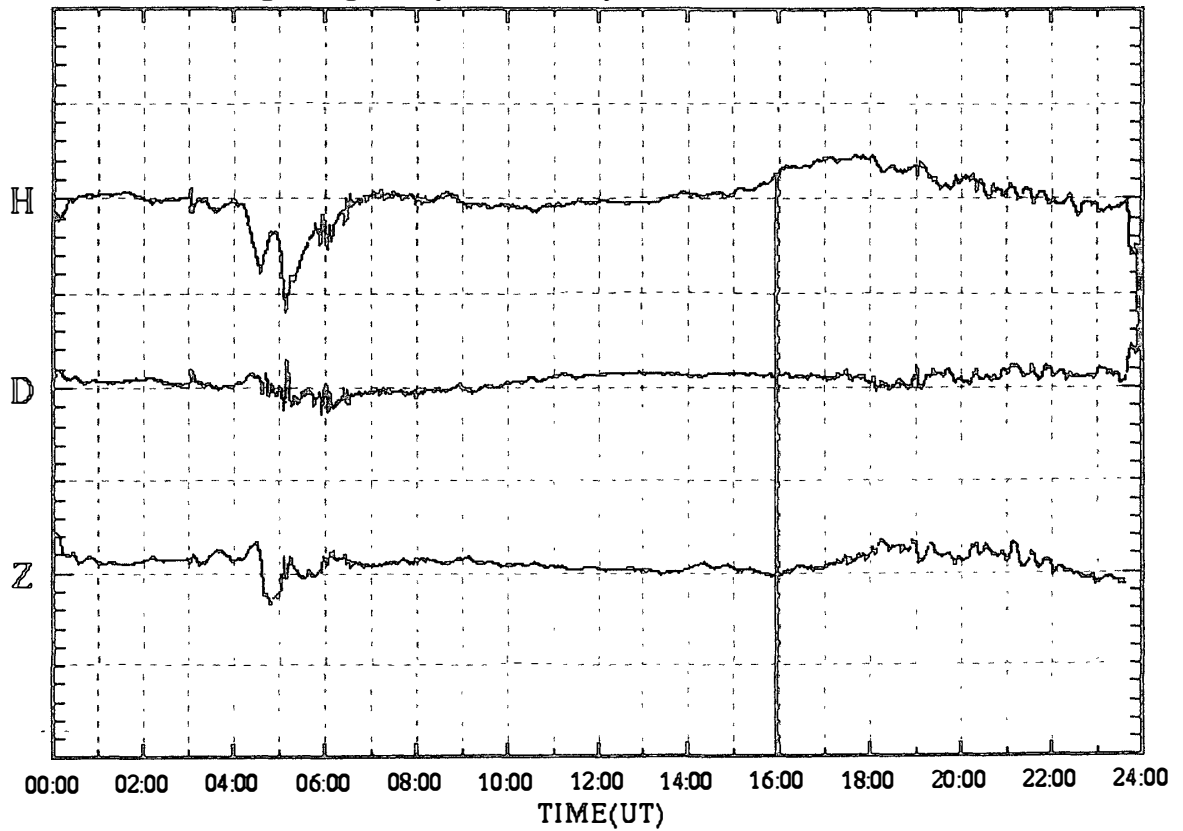

SYOWA magnetogram (100 nT/div)

12 Feb.2000 (DAY:043)

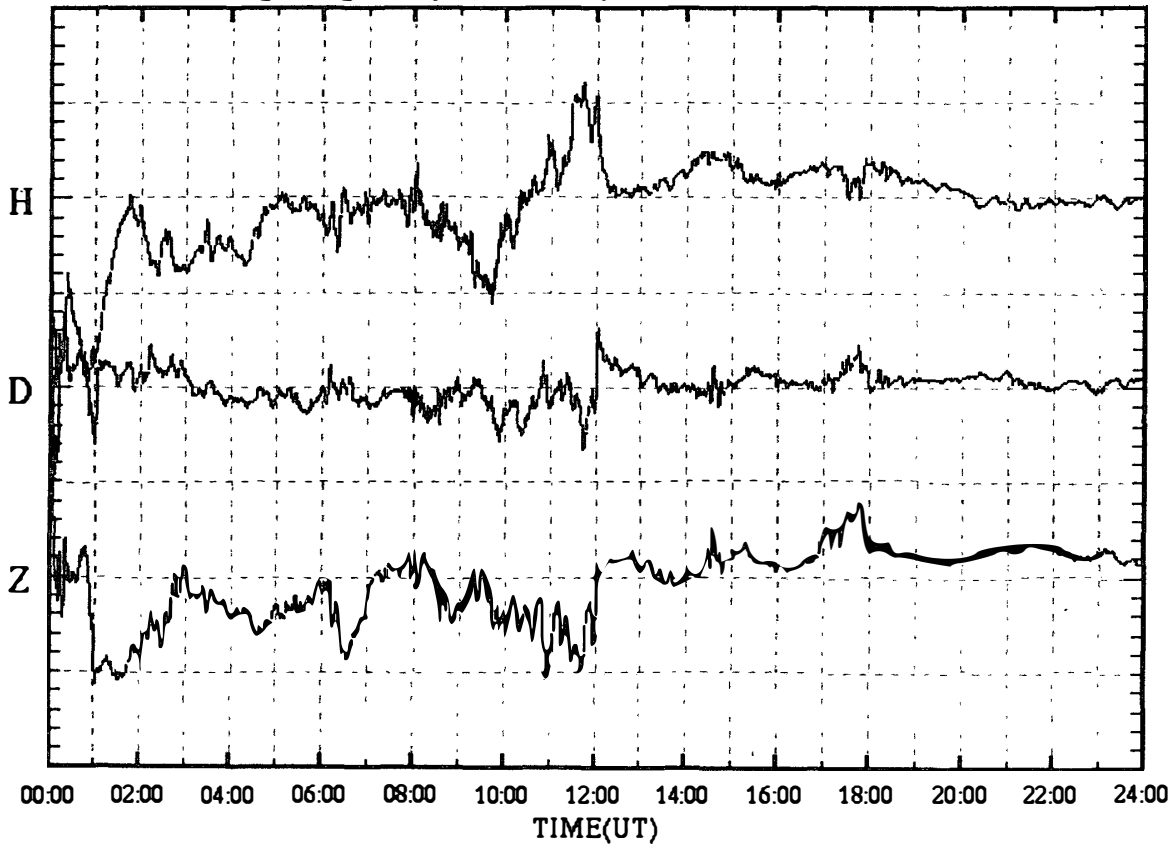

SYOWA magnetogram (100 nT/div)

13 Feb.2000 (DAY:044)

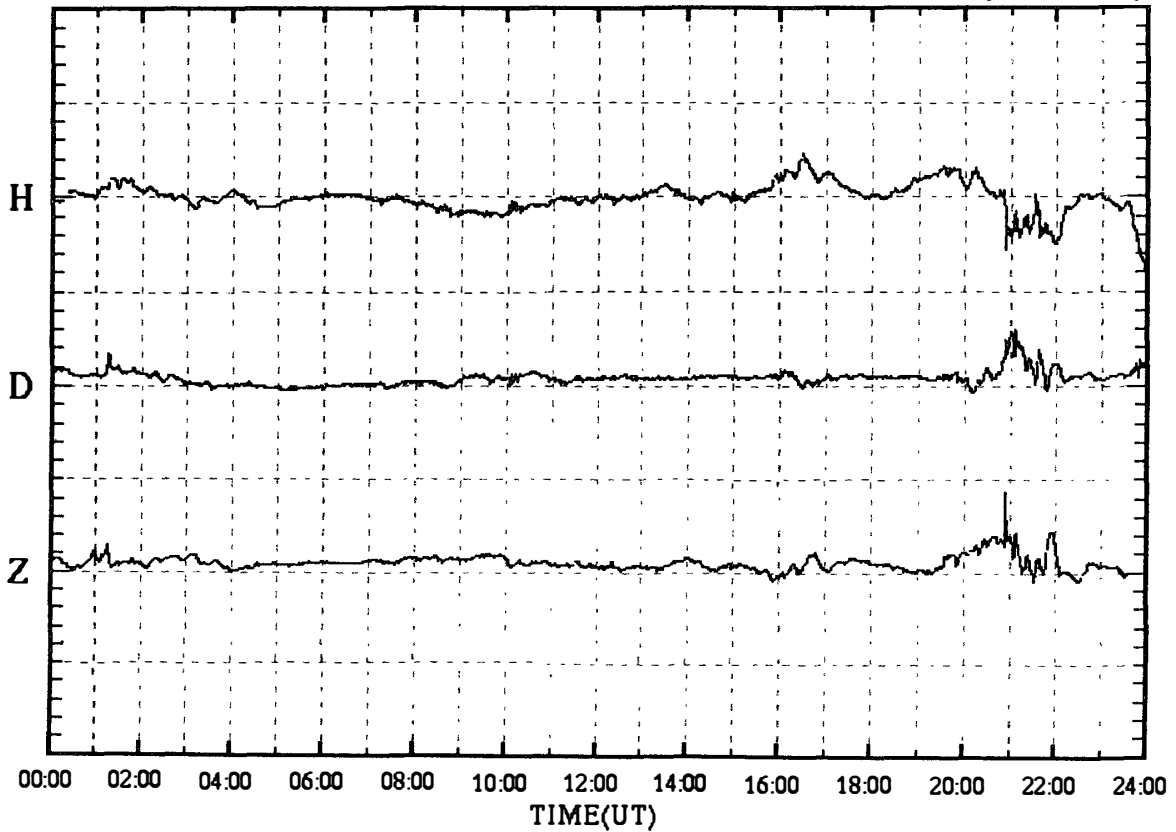

SYOWA magnetogram (100 nT/div)

14 Feb.2000 (DAY:045)

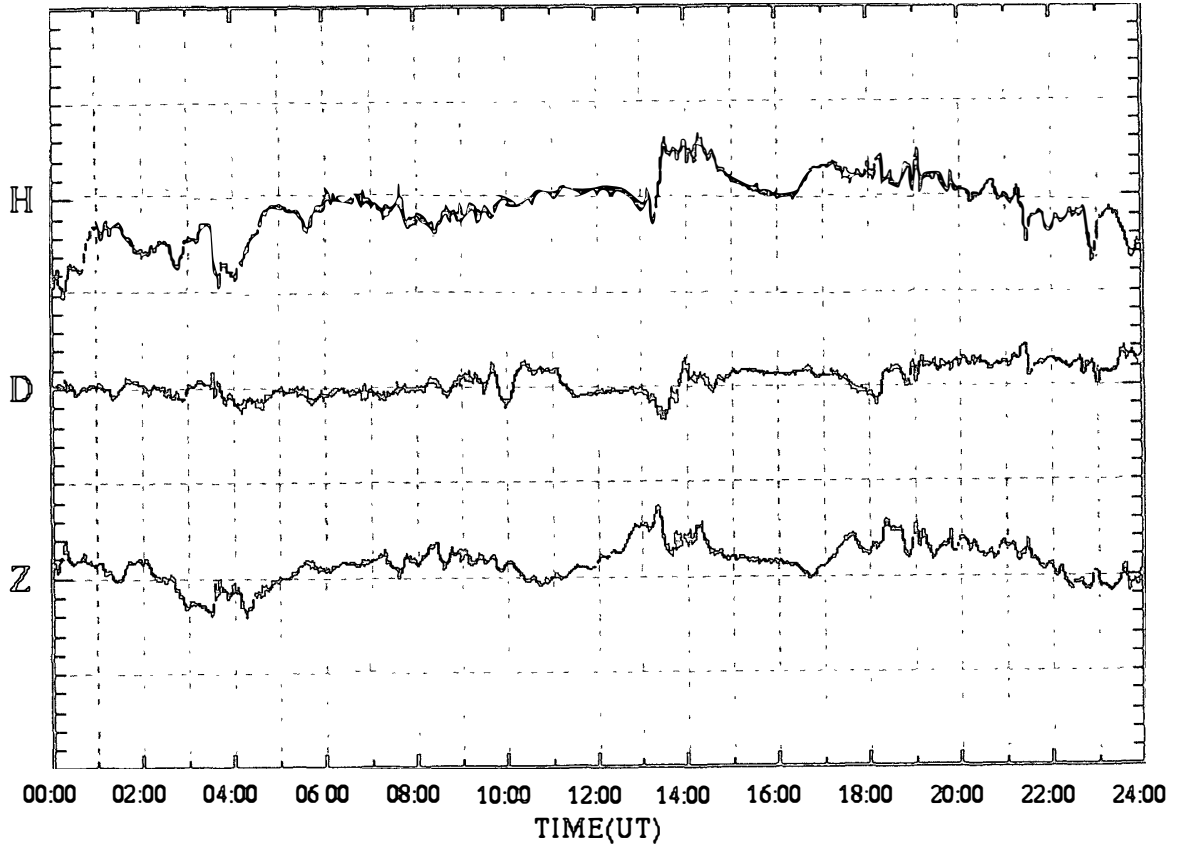

SYOWA magnetogram (100 nT/div)

15 Feb.2000 (DAY:046)

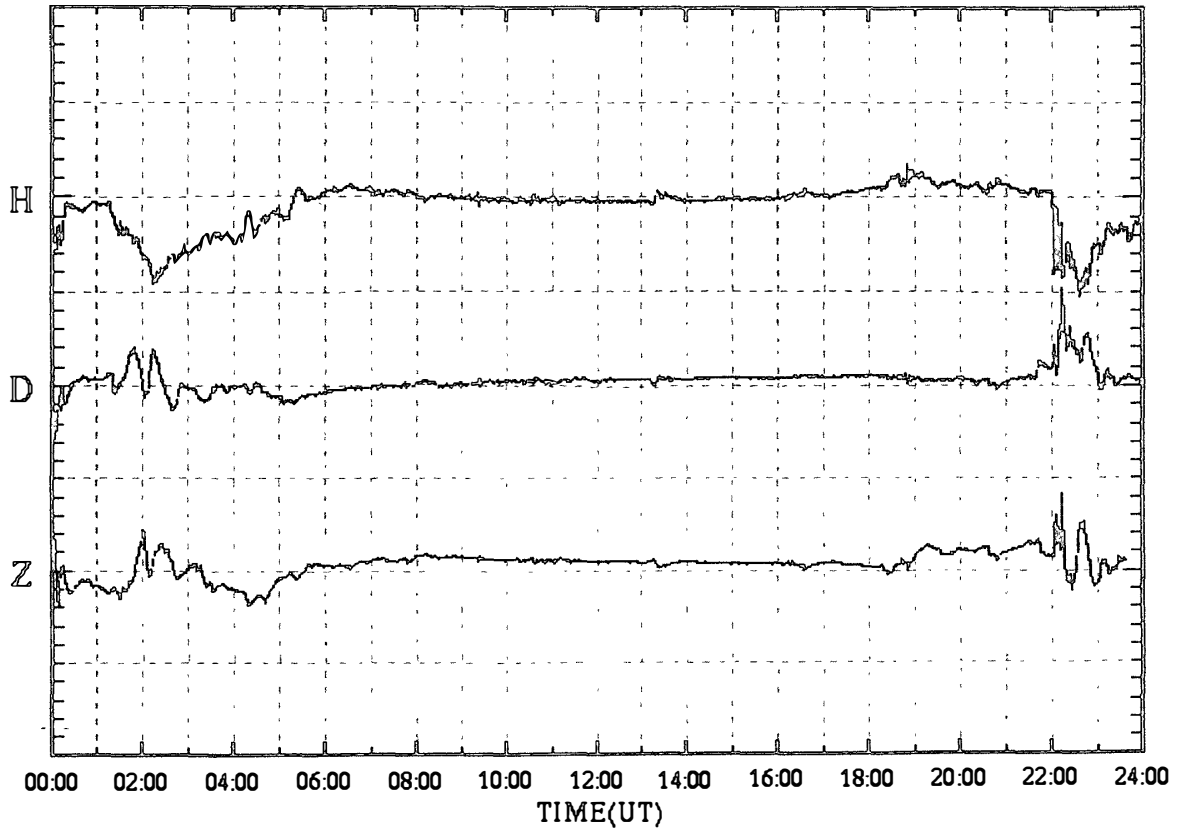

SYOWA magnetogram (100 nT/div)

16 Feb.2000 (DAY:047)

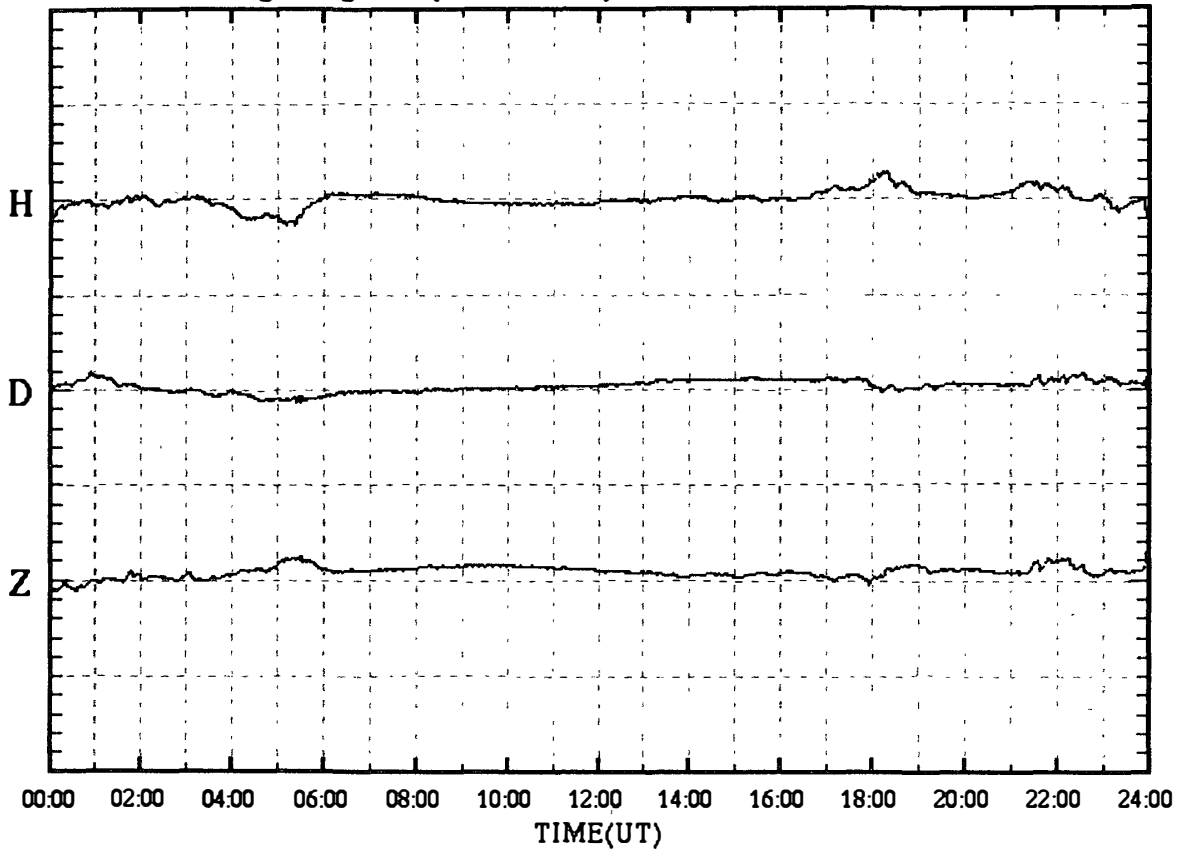

SYOWA magnetogram (100 nT/div)

17 Feb.2000 (DAY:048)

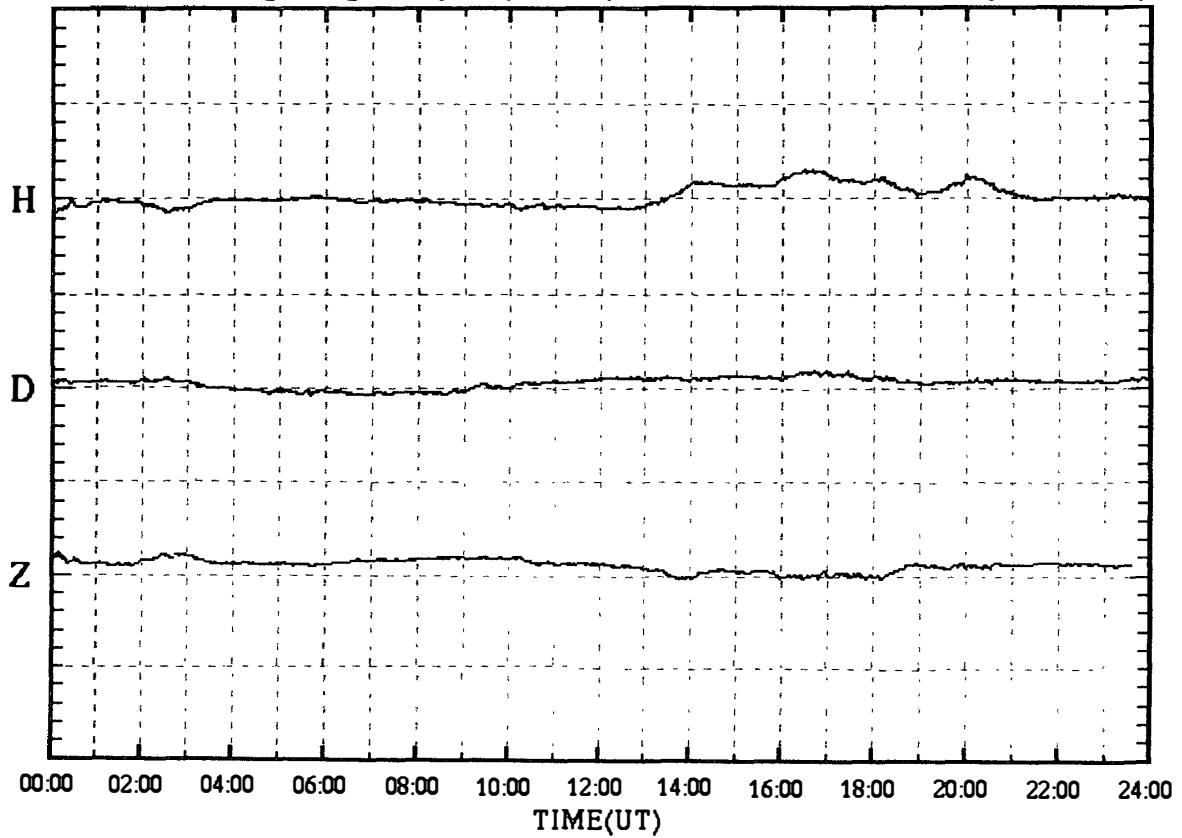

SYOWA magnetogram (100 nT/div)

18 Feb.2000 (DAY:049)

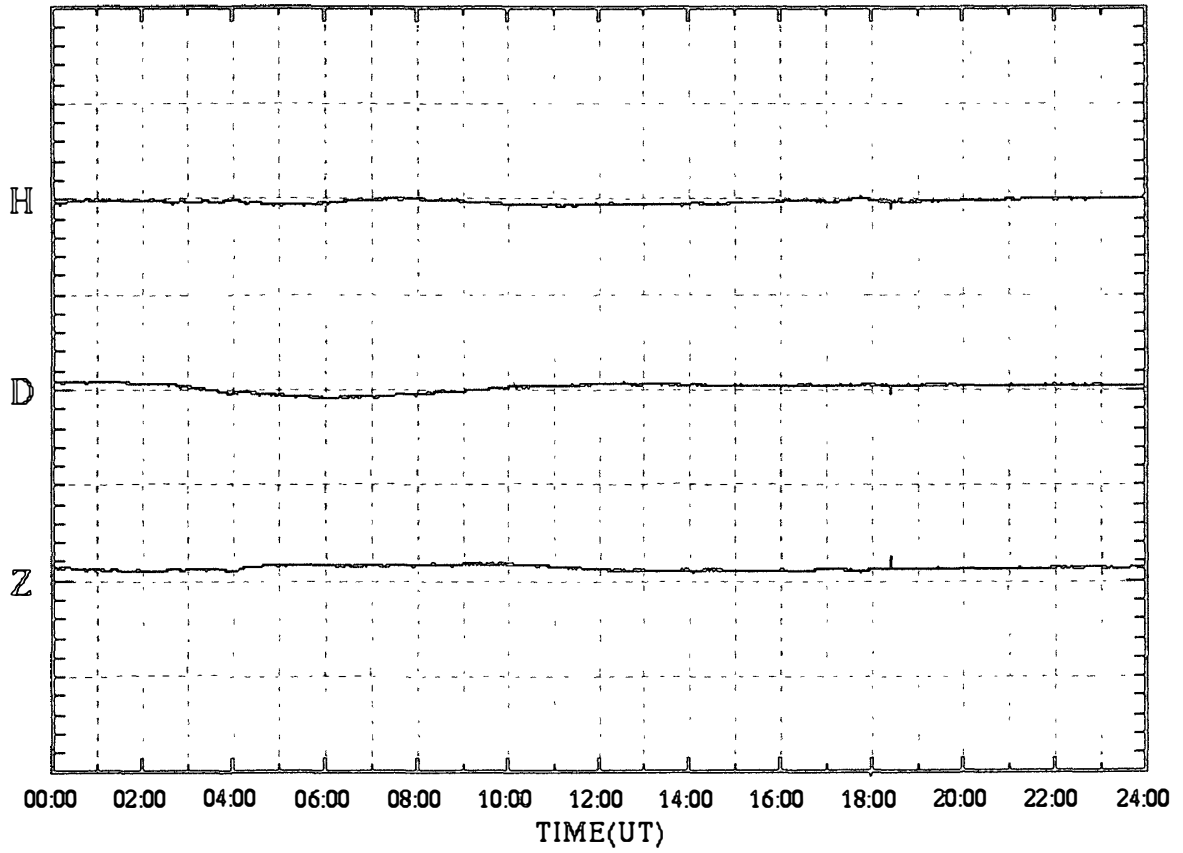

SYOWA magnetogram (100 nT/div)

19 Feb.2000 (DAY:050)

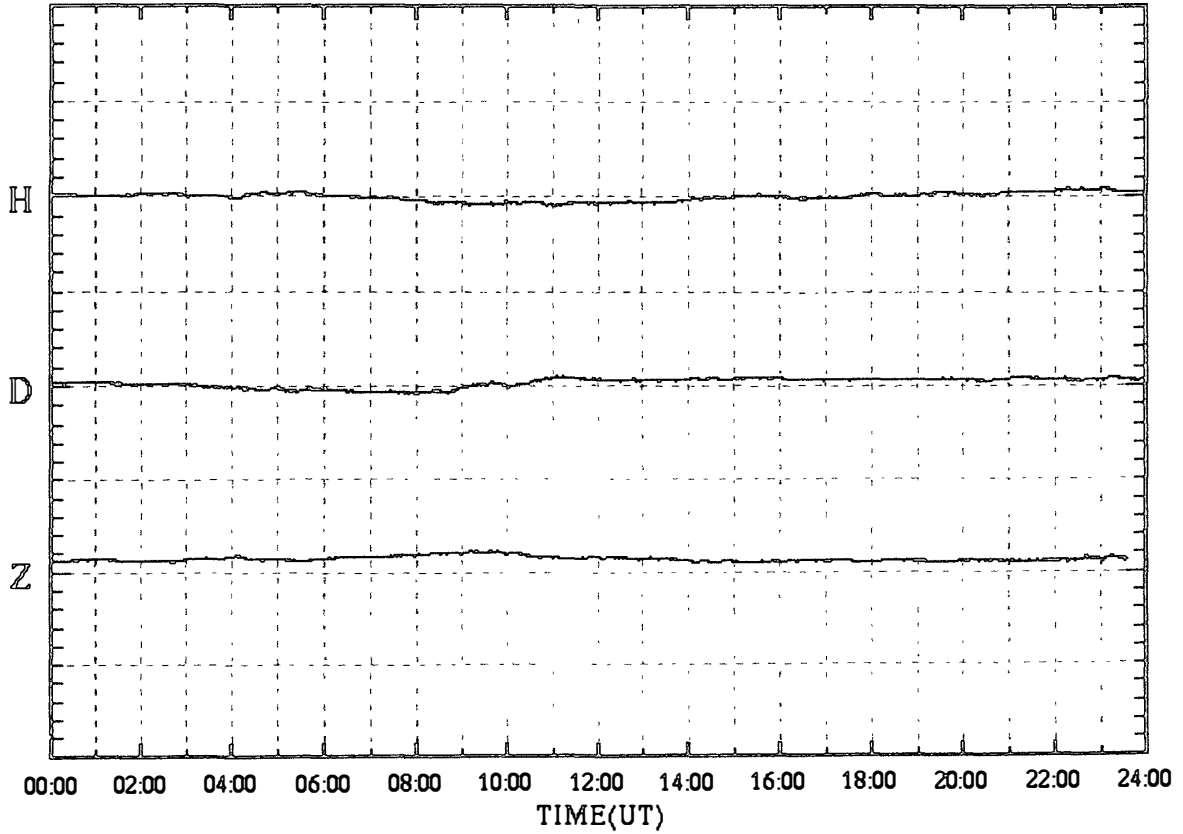

SYOWA magnetogram (100 nT/div)

20 Feb.2000 (DAY:051)

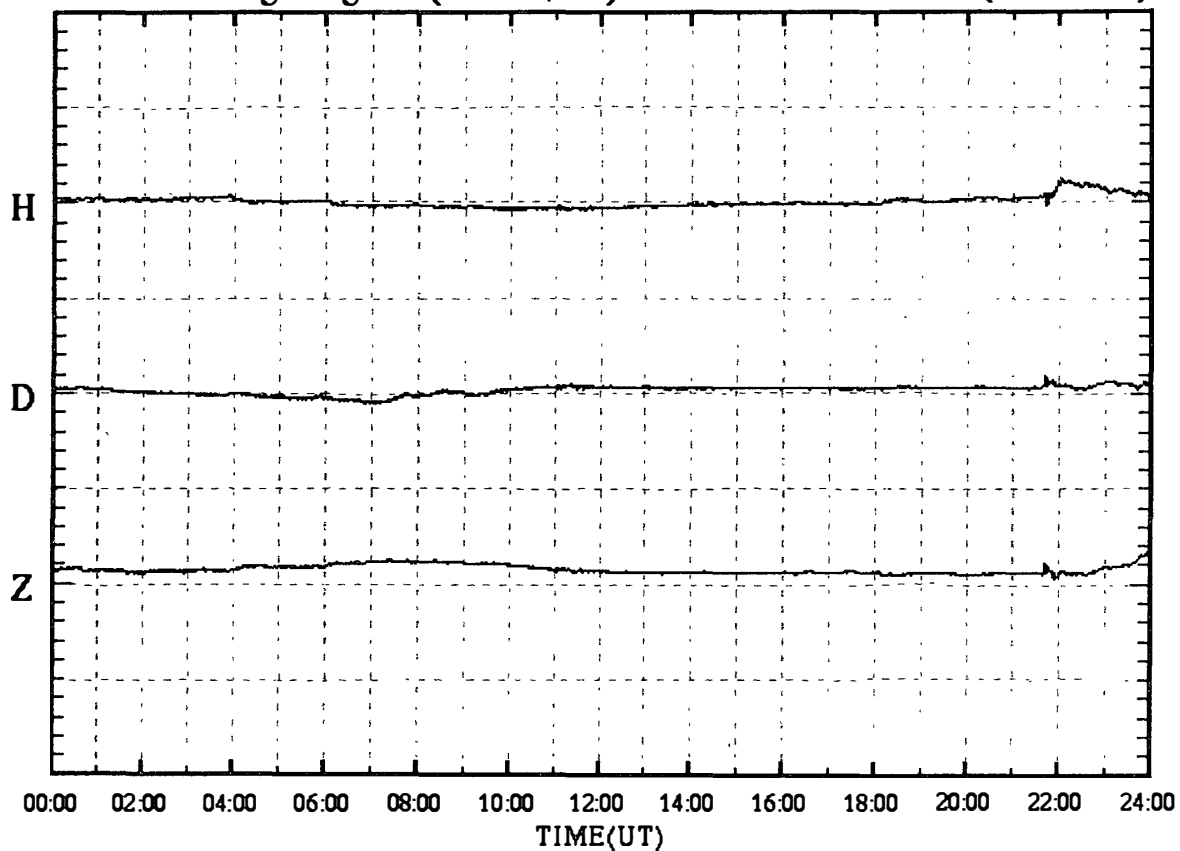

SYOWA magnetogram (100 nT/div)

21 Feb.2000 (DAY:052)

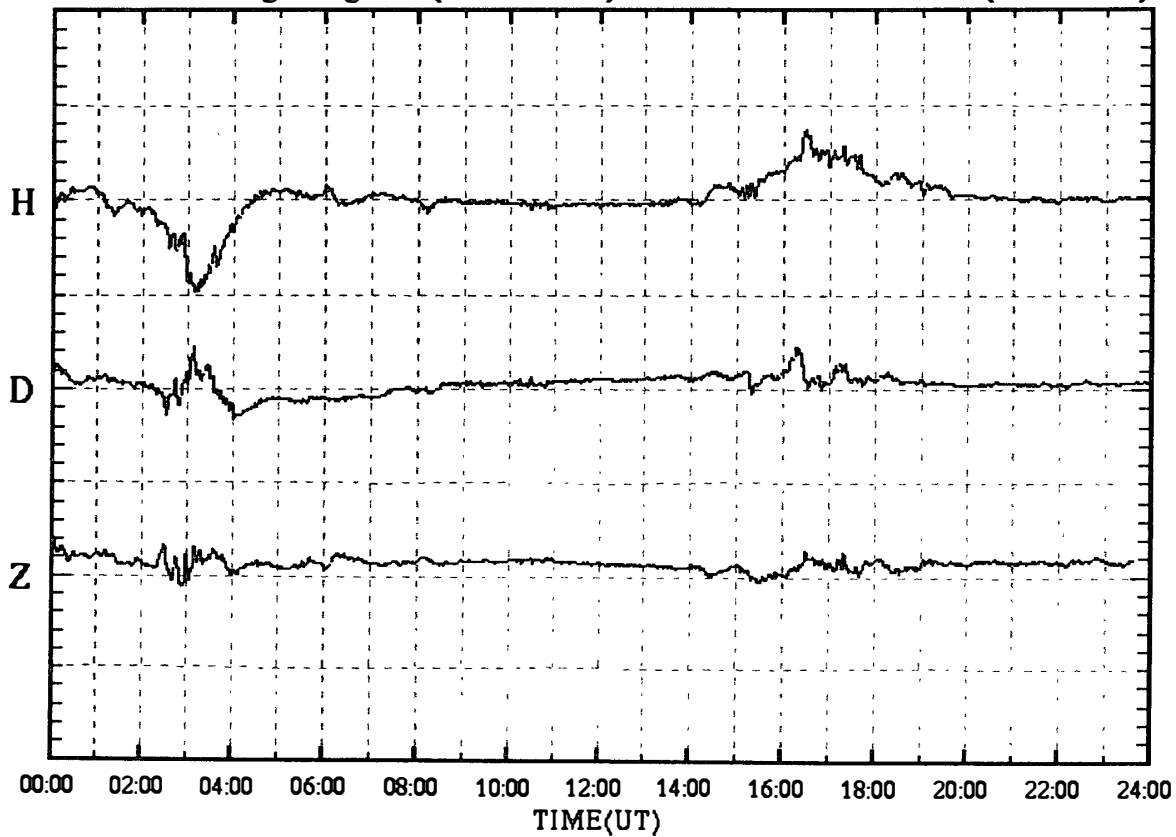

SYOWA magnetogram (100 nT/div)

22 Feb.2000 (DAY:053)

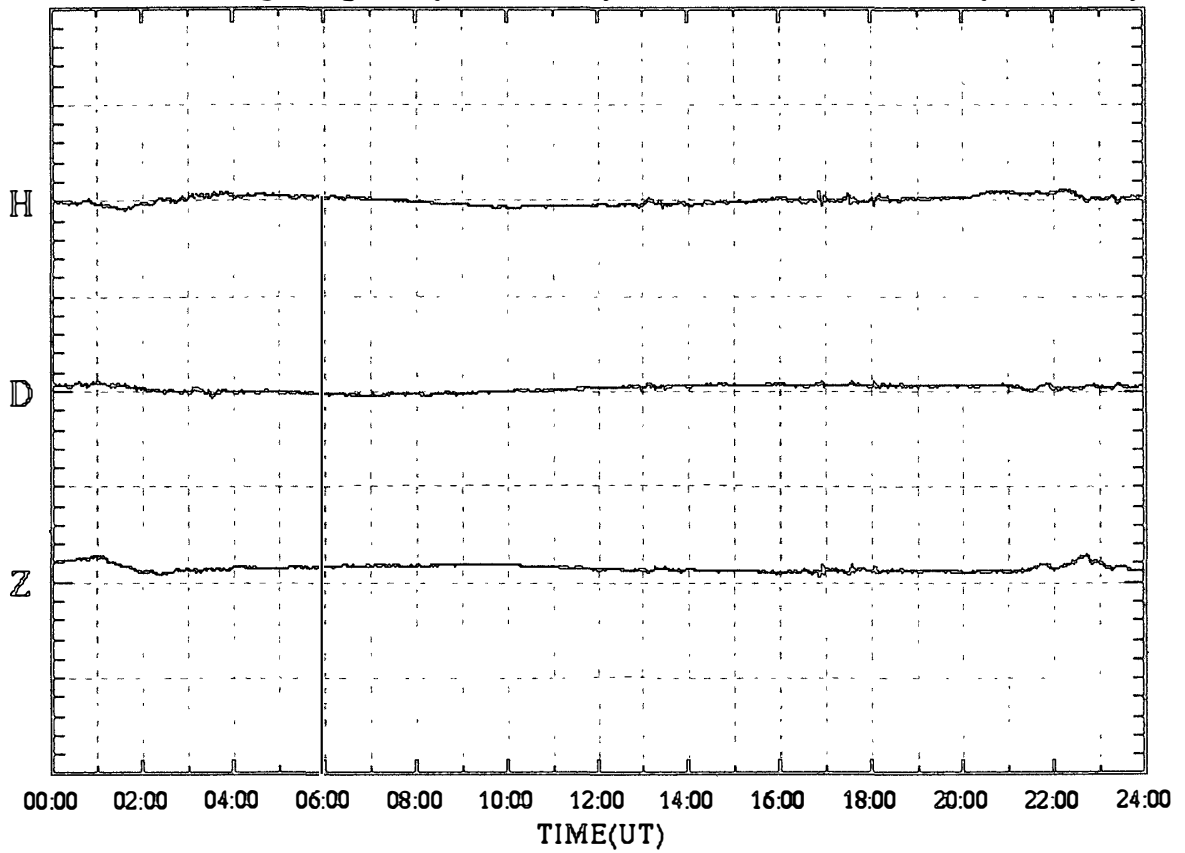

SYOWA magnetogram (100 nT/div)

23 Feb.2000 (DAY:054)

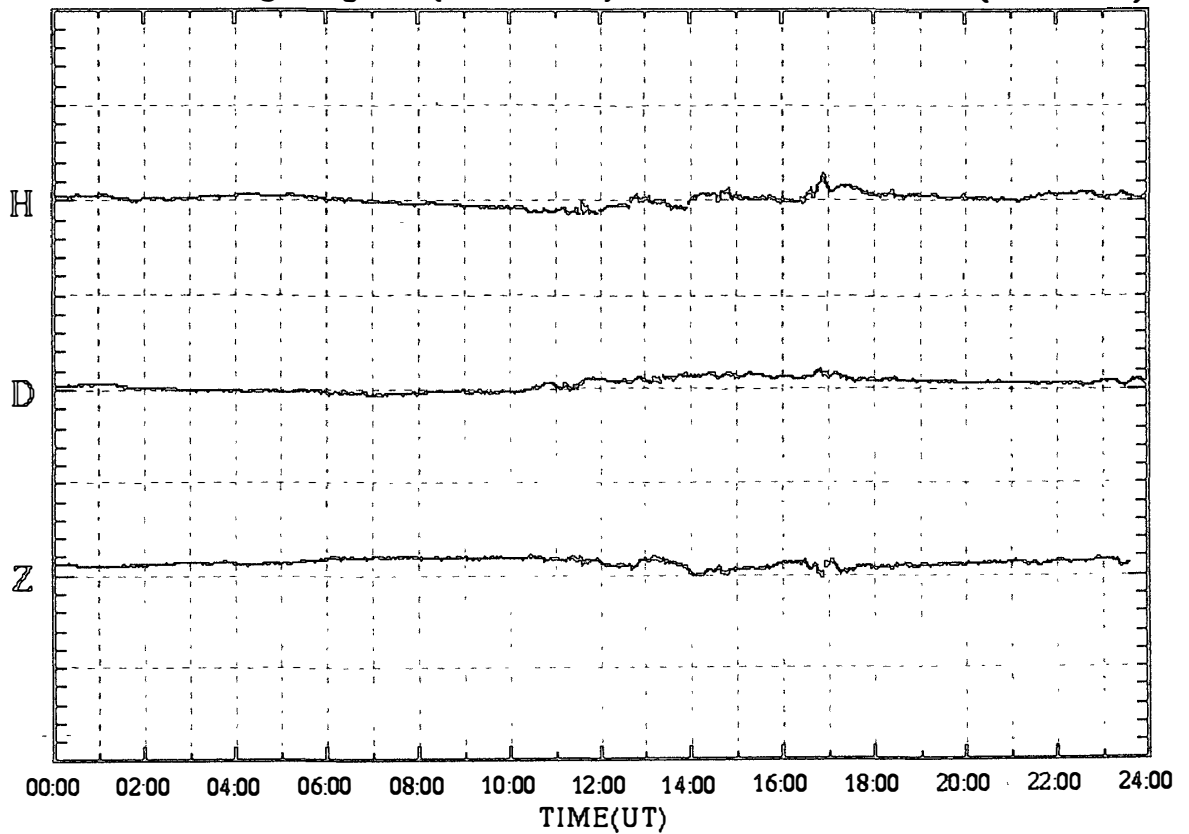

SYOWA magnetogram (100 nT/div)

24 Feb.2000 (DAY:055)

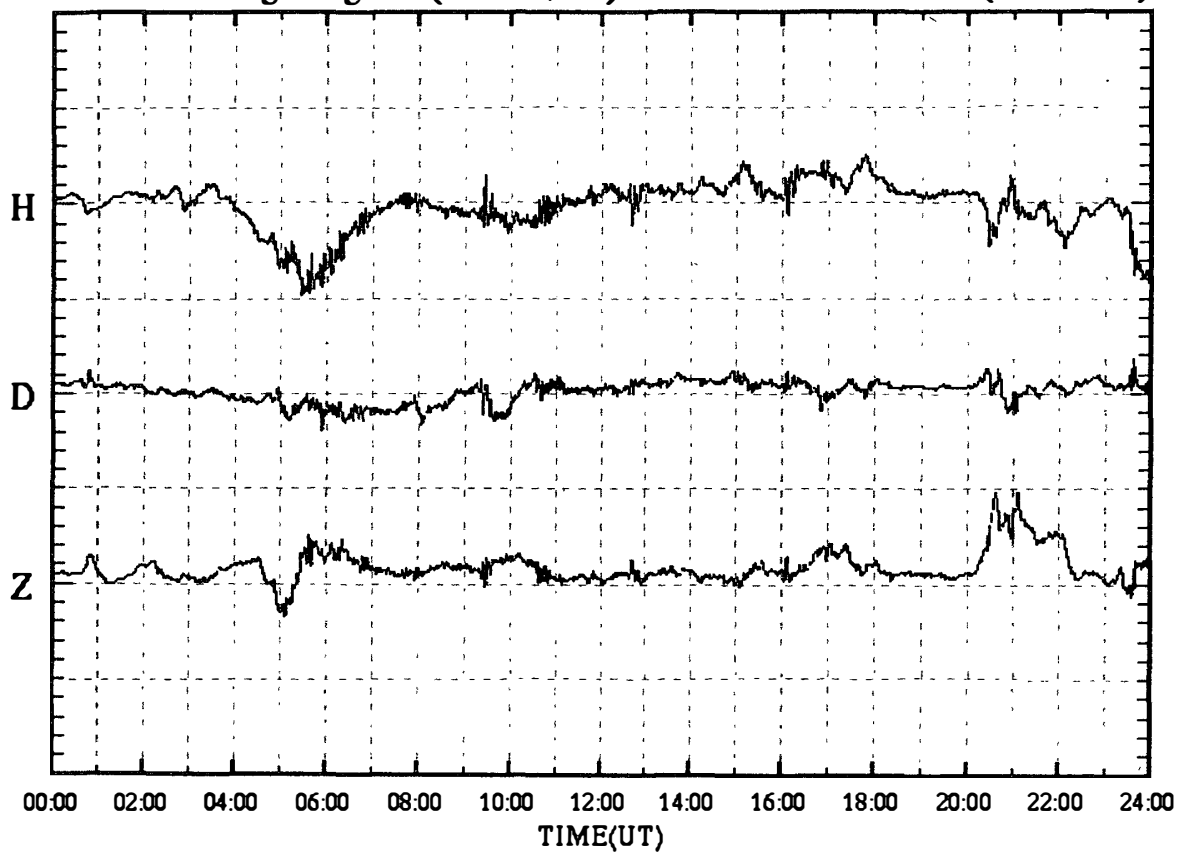

SYOWA magnetogram (100 nT/div)

25 Feb.2000 (DAY:056)

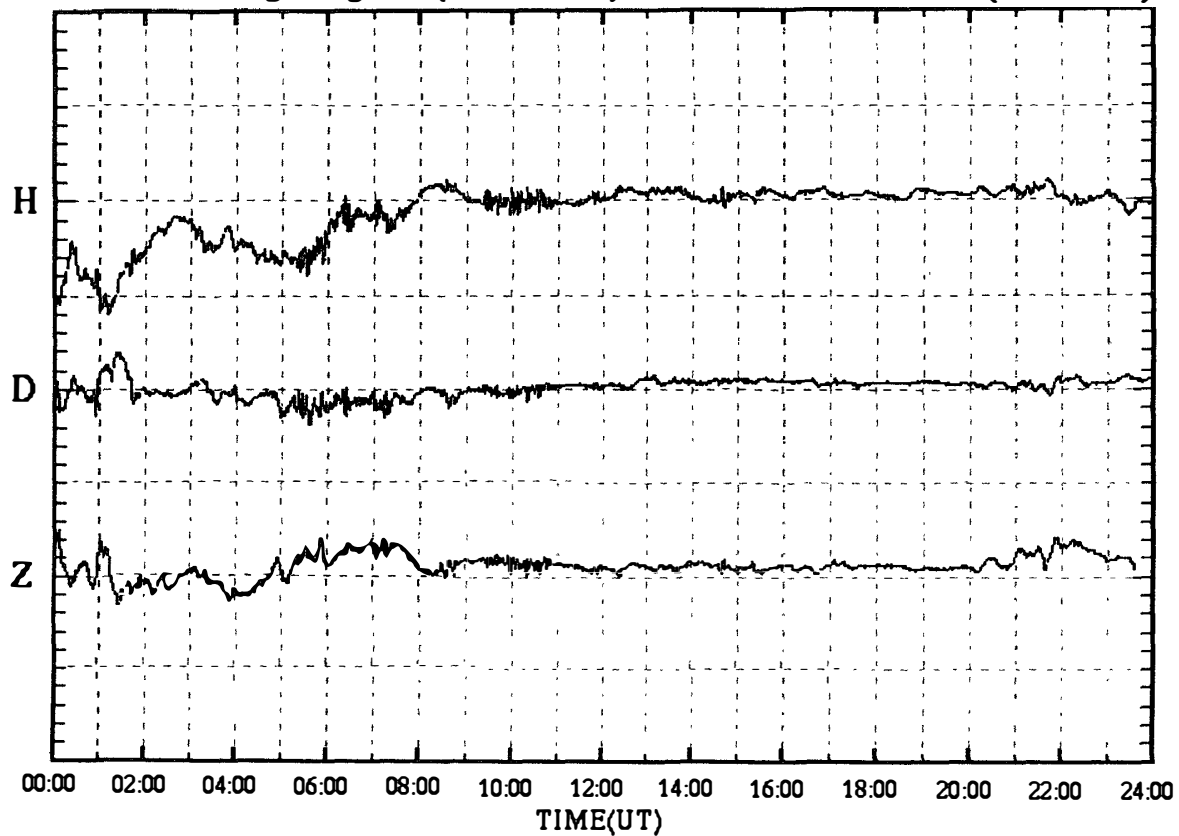

SYOWA magnetogram (100 nT/div)

26 Feb.2000 (DAY:057)

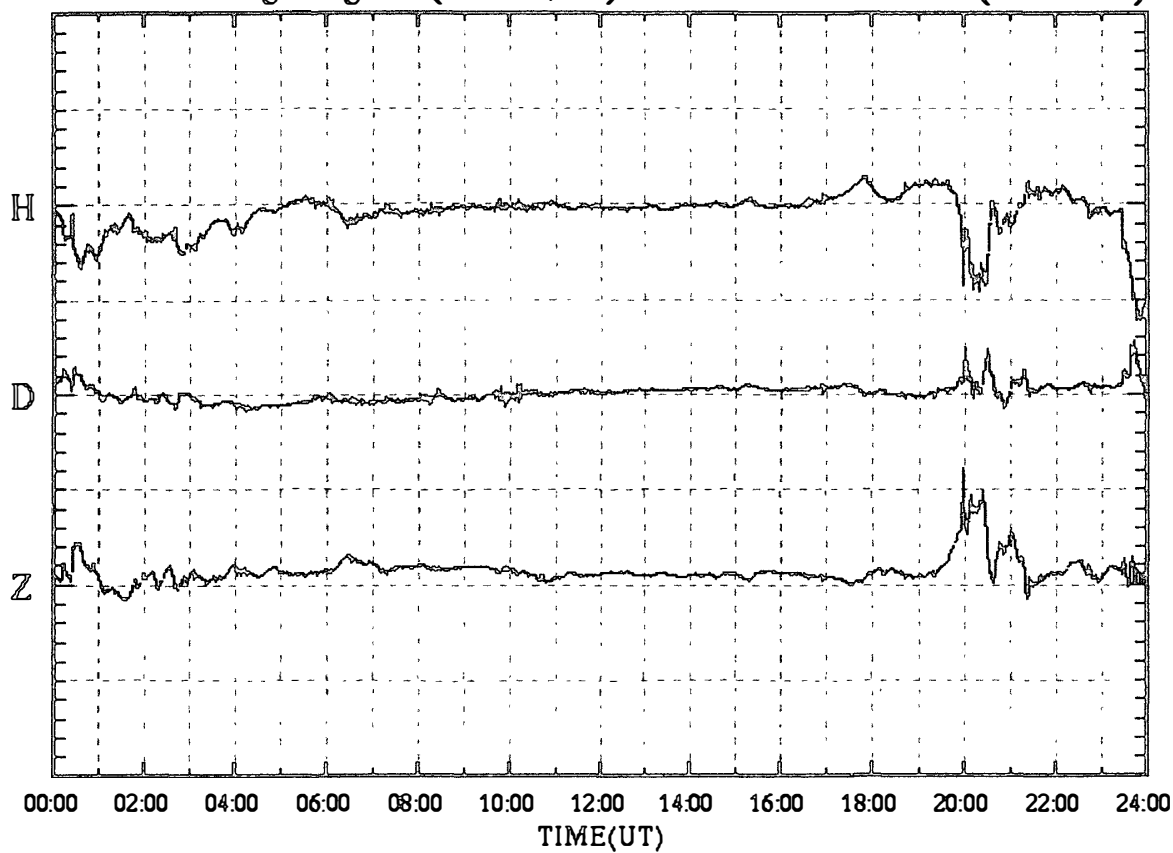

SYOWA magnetogram (100 nT/div)

27 Feb.2000 (DAY:058)

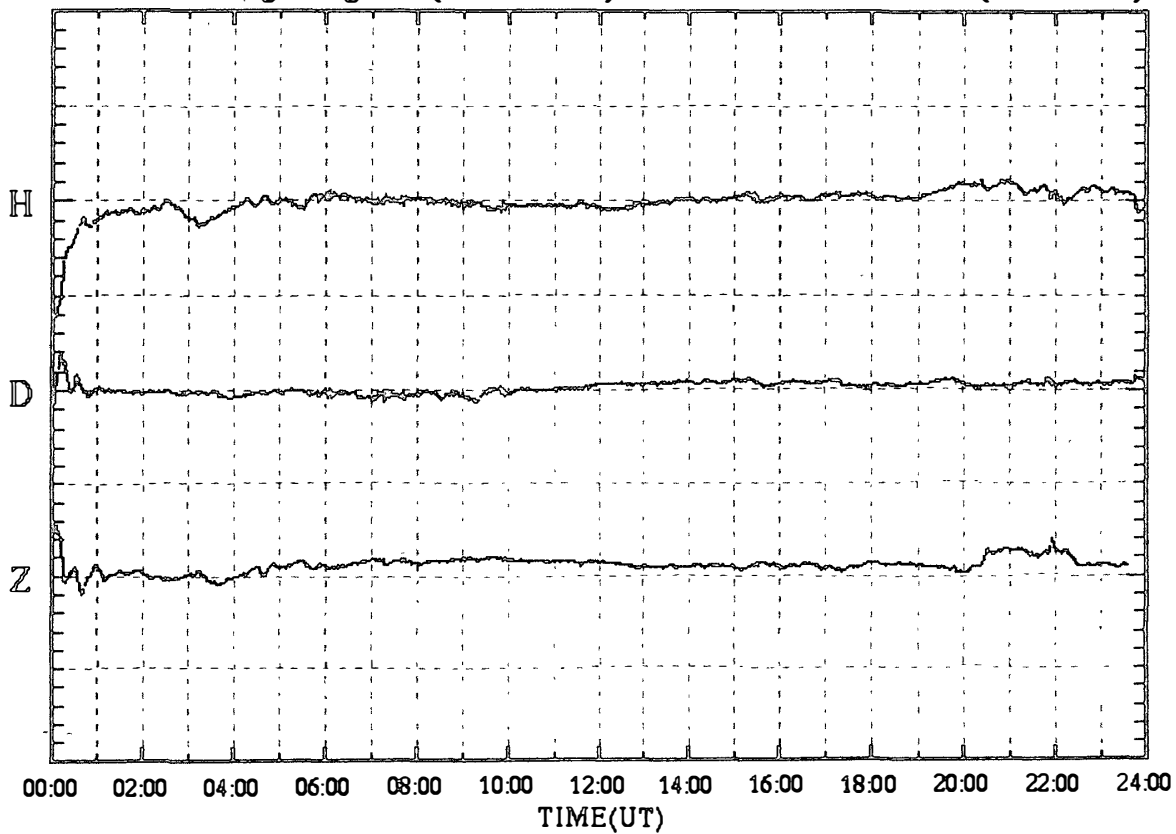

SYOWA magnetogram (100 nT/div)

28 Feb.2000 (DAY:059)

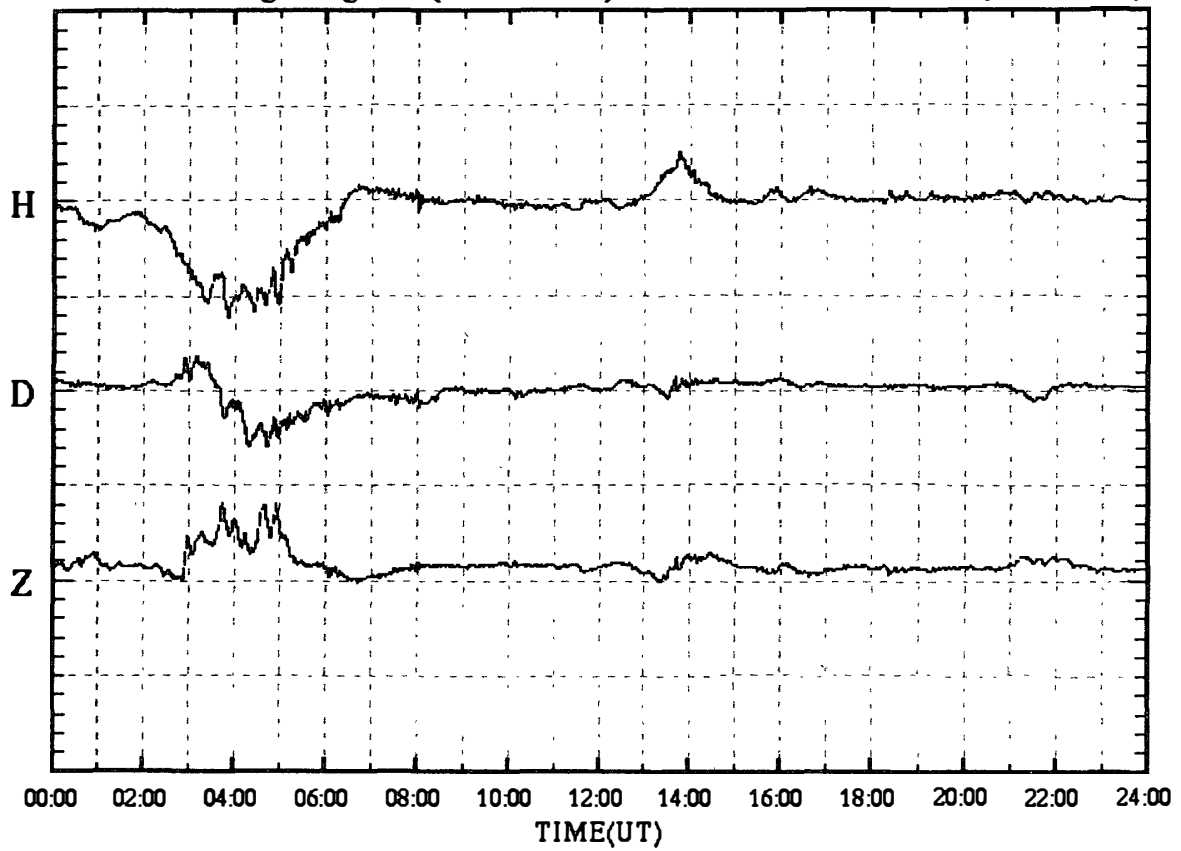

SYOWA magnetogram (100 nT/div)

29 Feb.2000 (DAY:060)

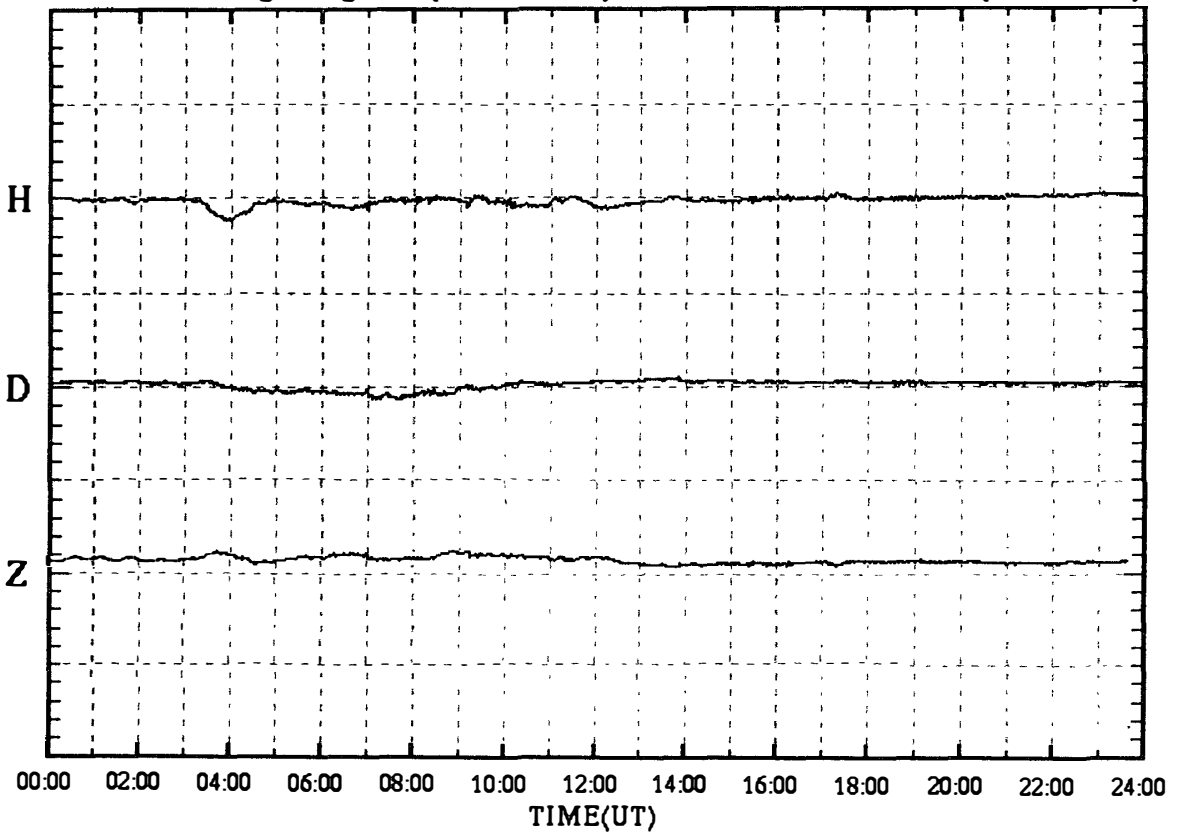

SYOWA magnetogram (100 nT/div)

01 Mar.2000 (DAY:061)

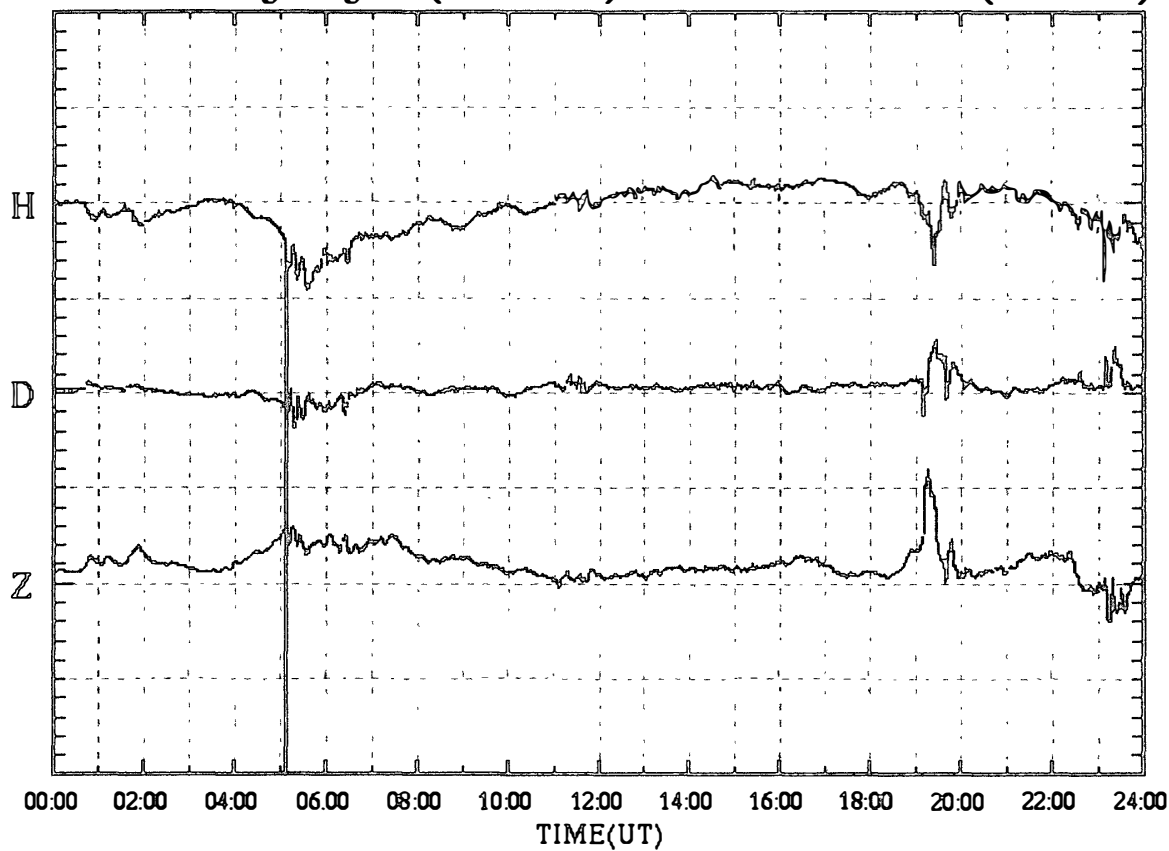

SYOWA magnetogram (100 nT/div)

02 Mar.2000 (DAY:062)

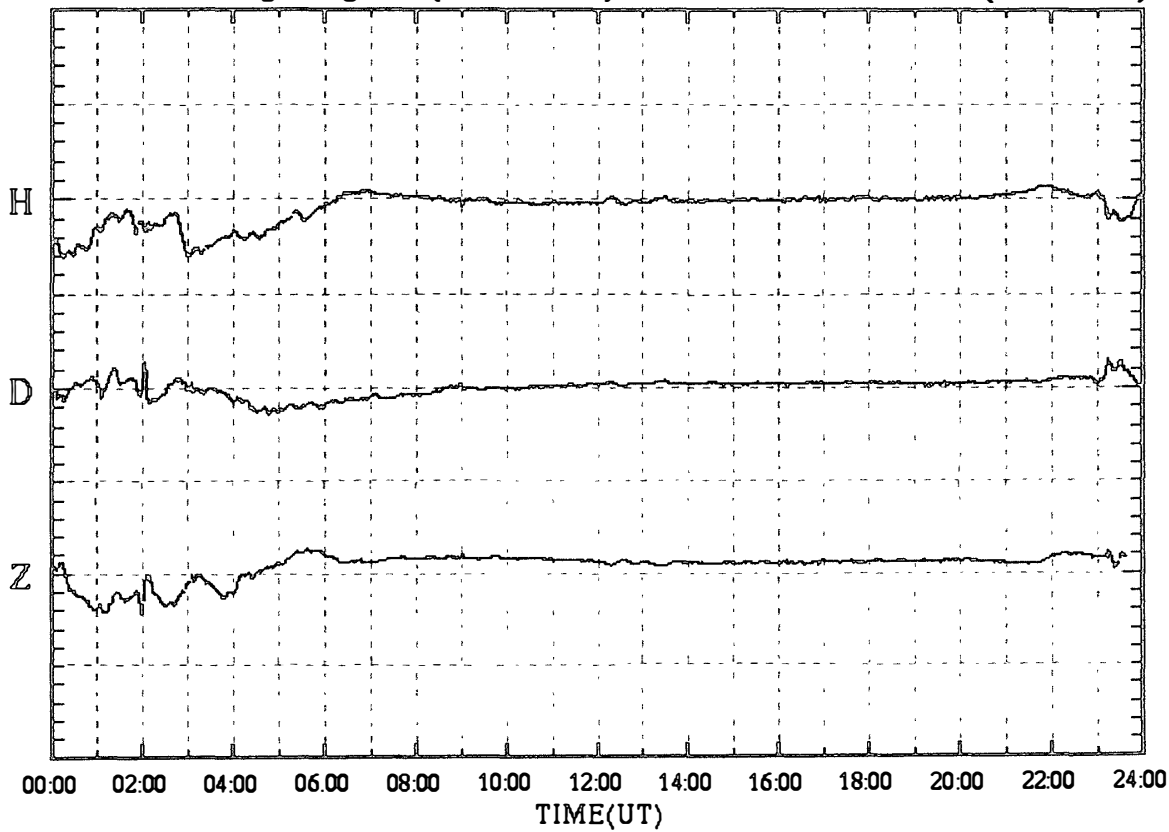

SYOWA magnetogram (100 nT/div)

03 Mar.2000 (DAY:063)

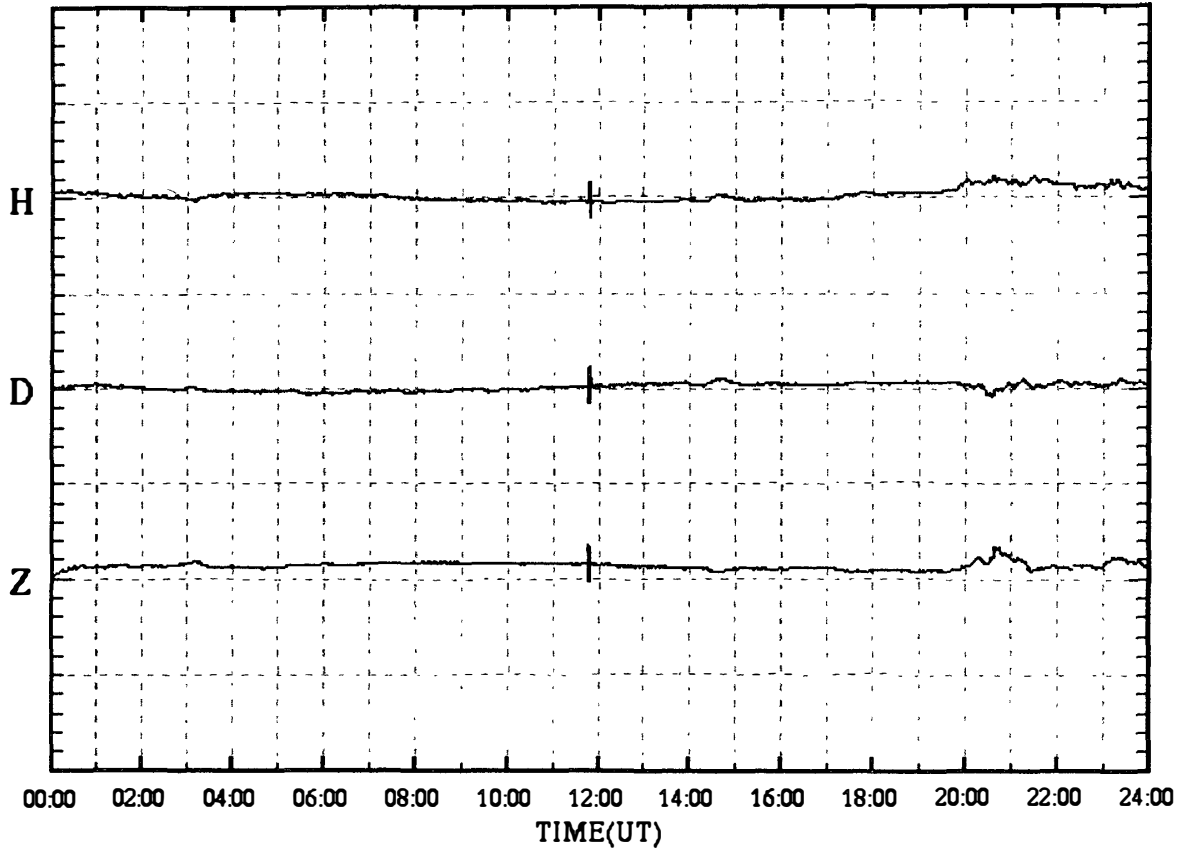

SYOWA magnetogram (100 nT/div)

04 Mar.2000 (DAY:064)

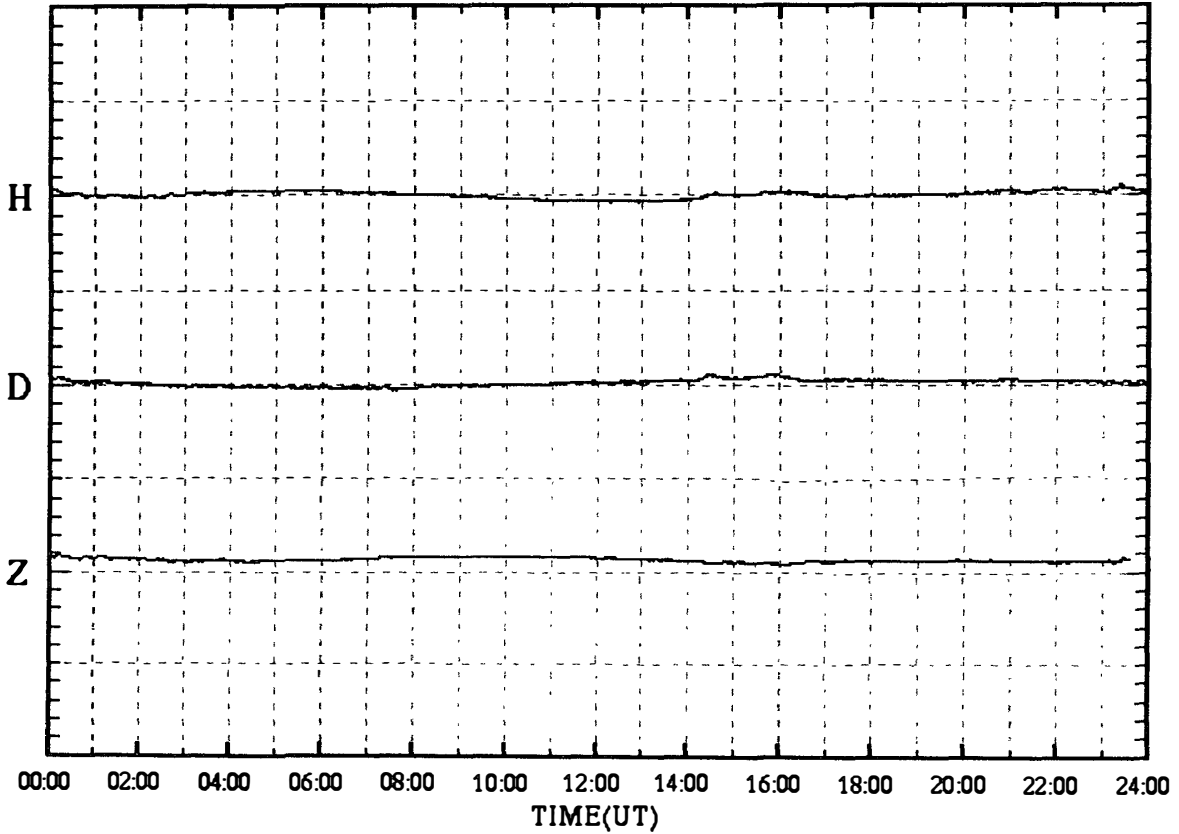

SYOWA magnetogram (100 nT/div)

05 Mar.2000 (DAY:065)

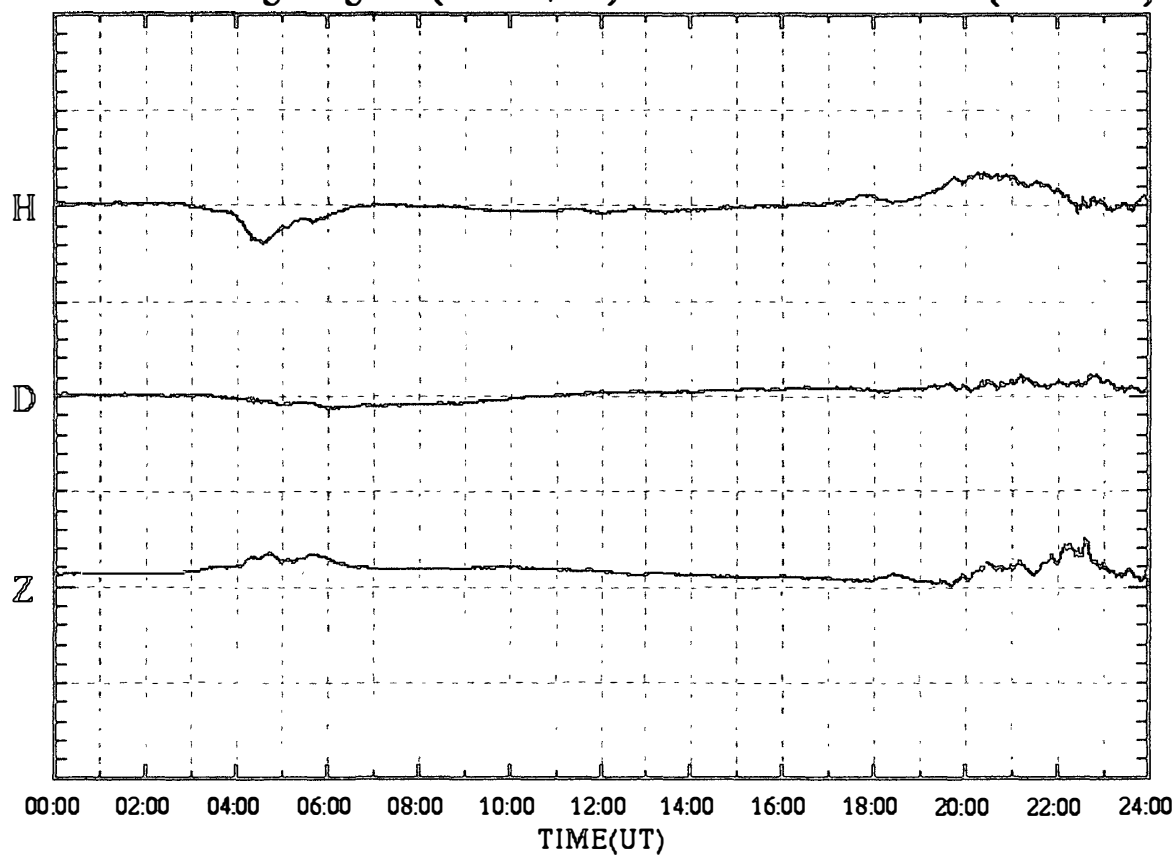

SYOWA magnetogram (100 nT/div)

06 Mar.2000 (DAY:066)

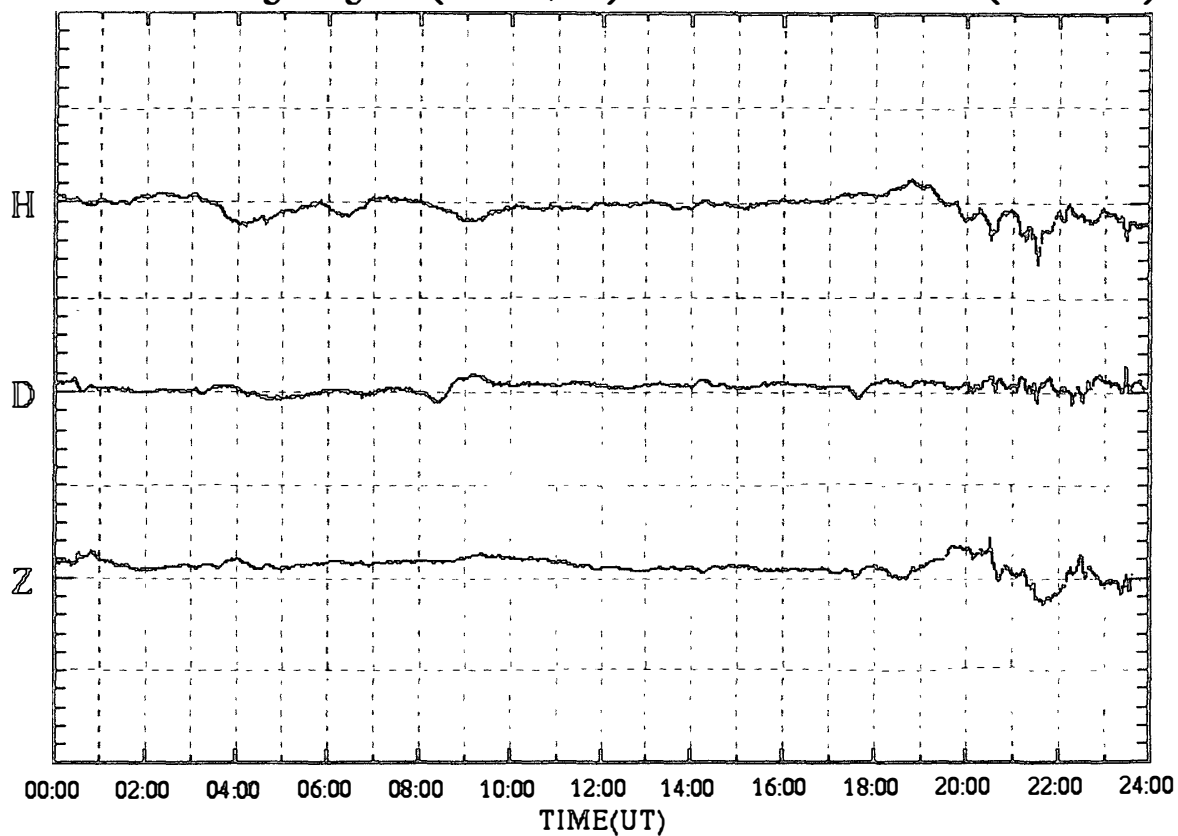

SYOWA magnetogram (100 nT/div)

07 Mar.2000 (DAY:067)

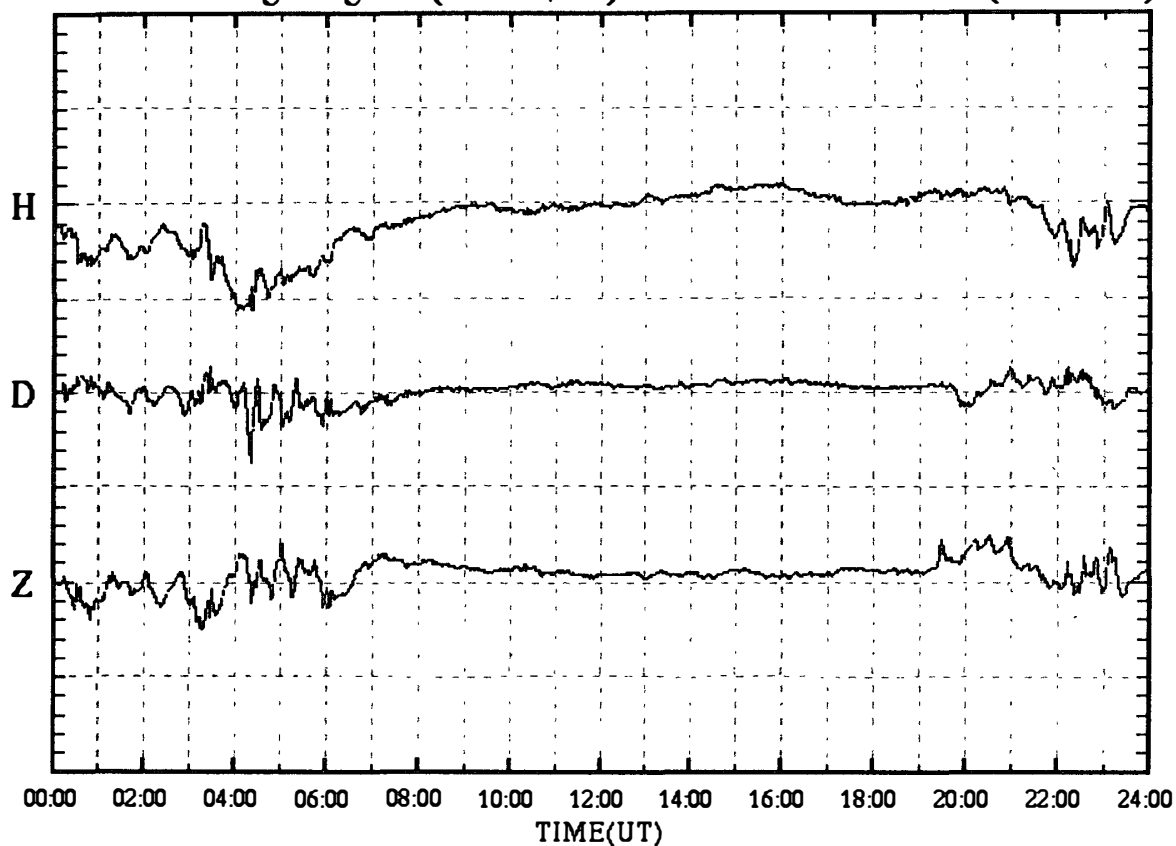

SYOWA magnetogram (100 nT/div)

08 Mar.2000 (DAY:068)

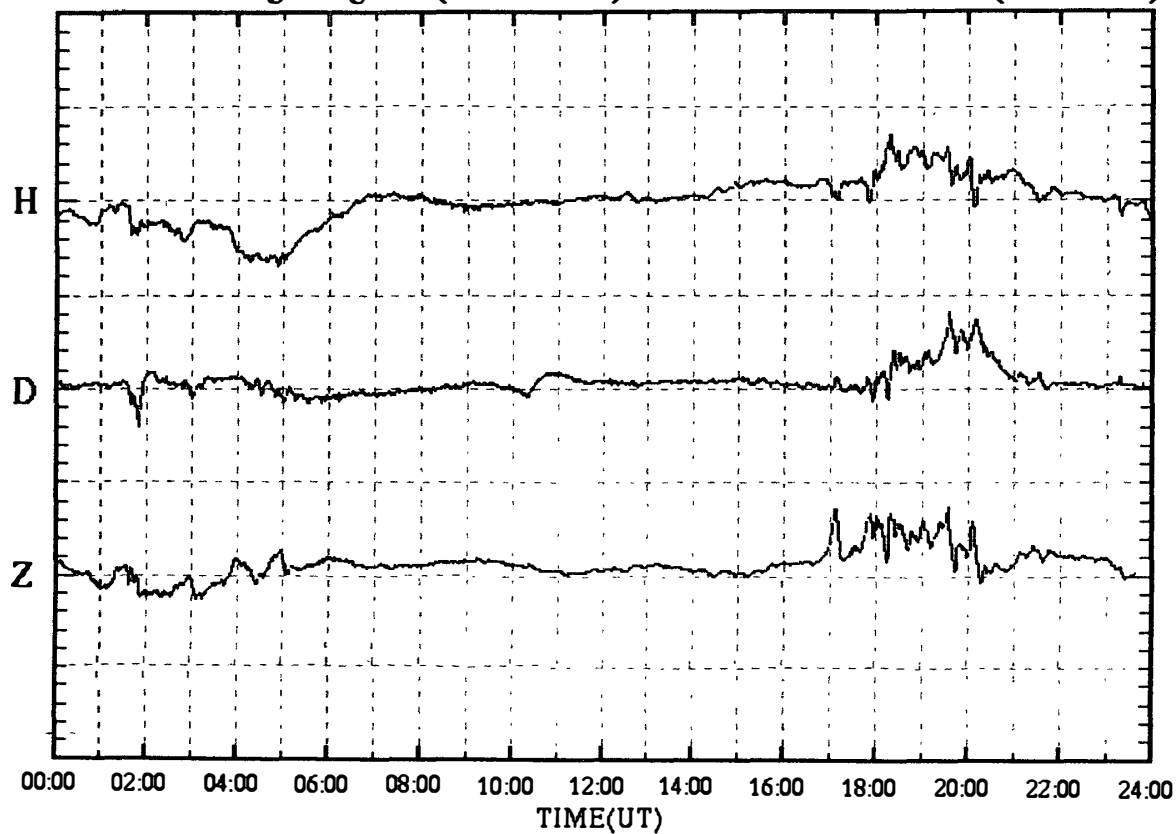

SYOWA magnetogram (100 nT/div)

09 Mar.2000 (DAY:069)

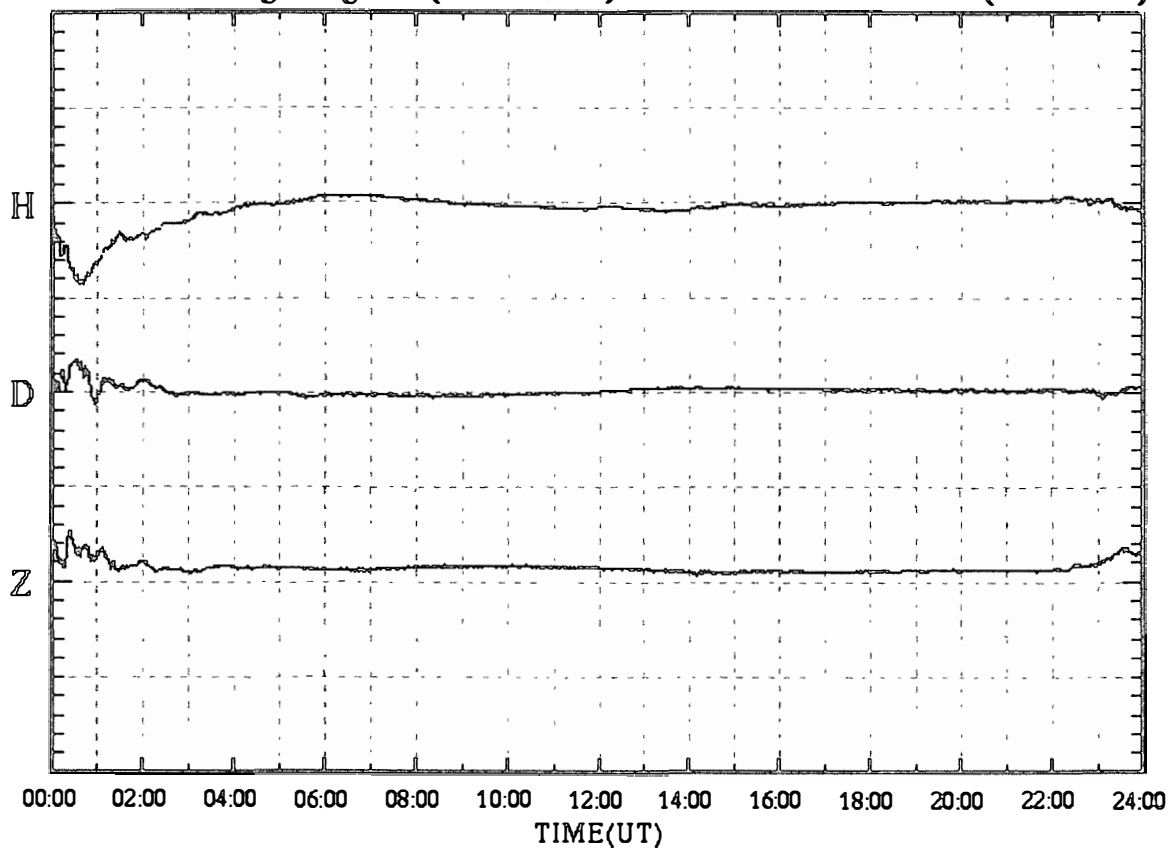

SYOWA magnetogram (100 nT/div)

10 Mar.2000 (DAY:070)

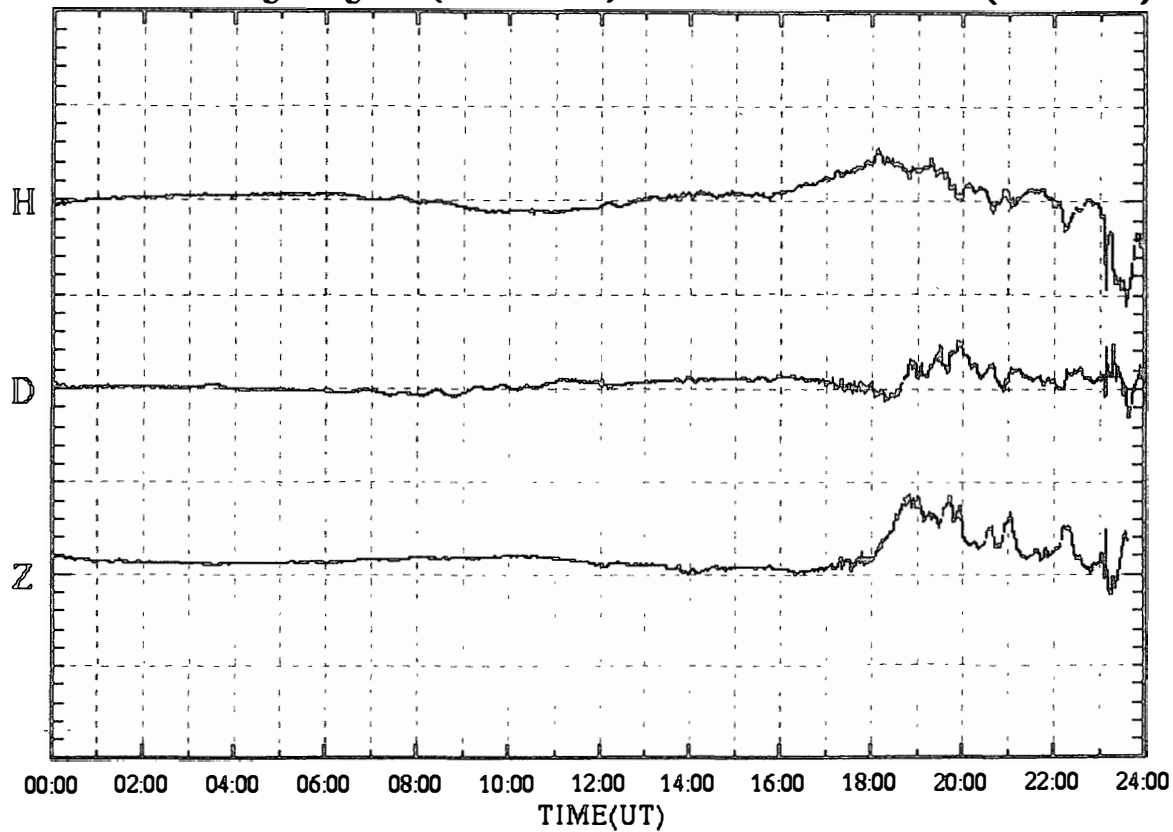

SYOWA magnetogram (100 nT/div)

11 Mar.2000 (DAY:071)

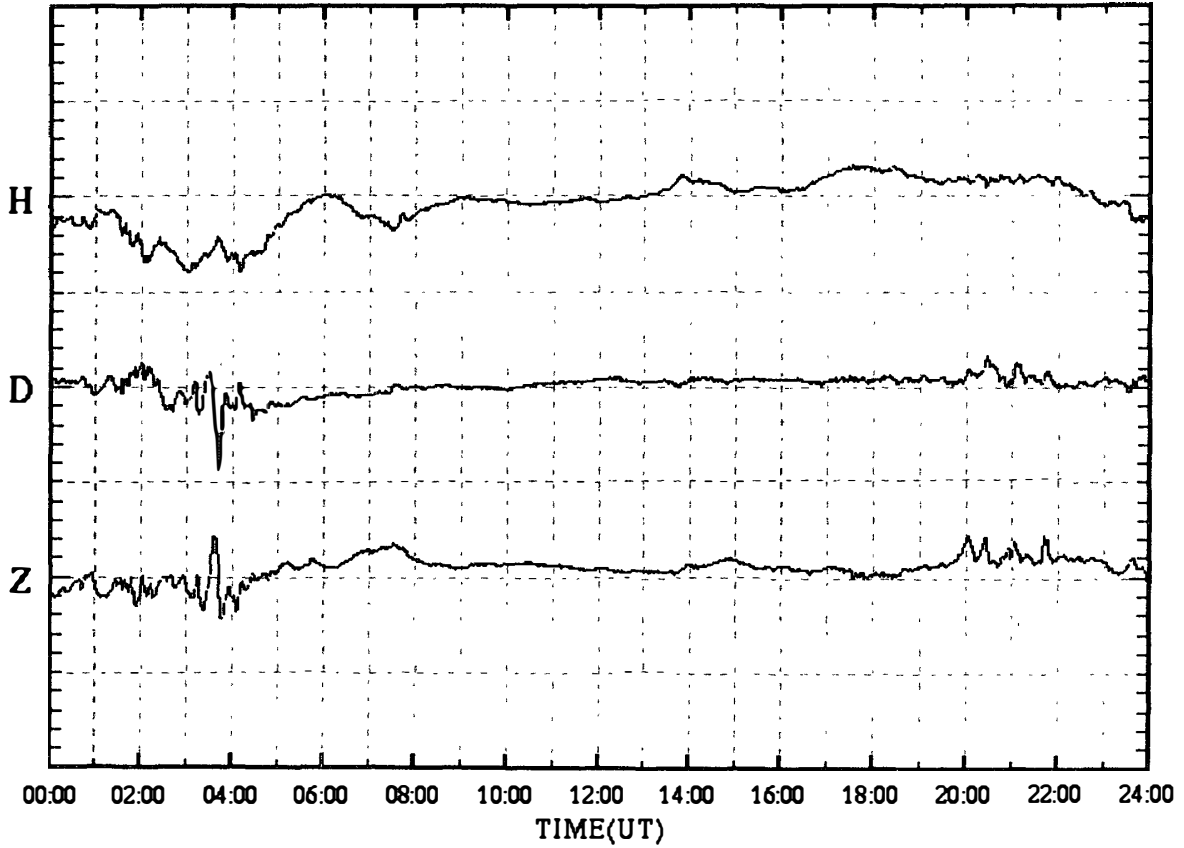

SYOWA magnetogram (100 nT/div)

12 Mar.2000 (DAY:072)

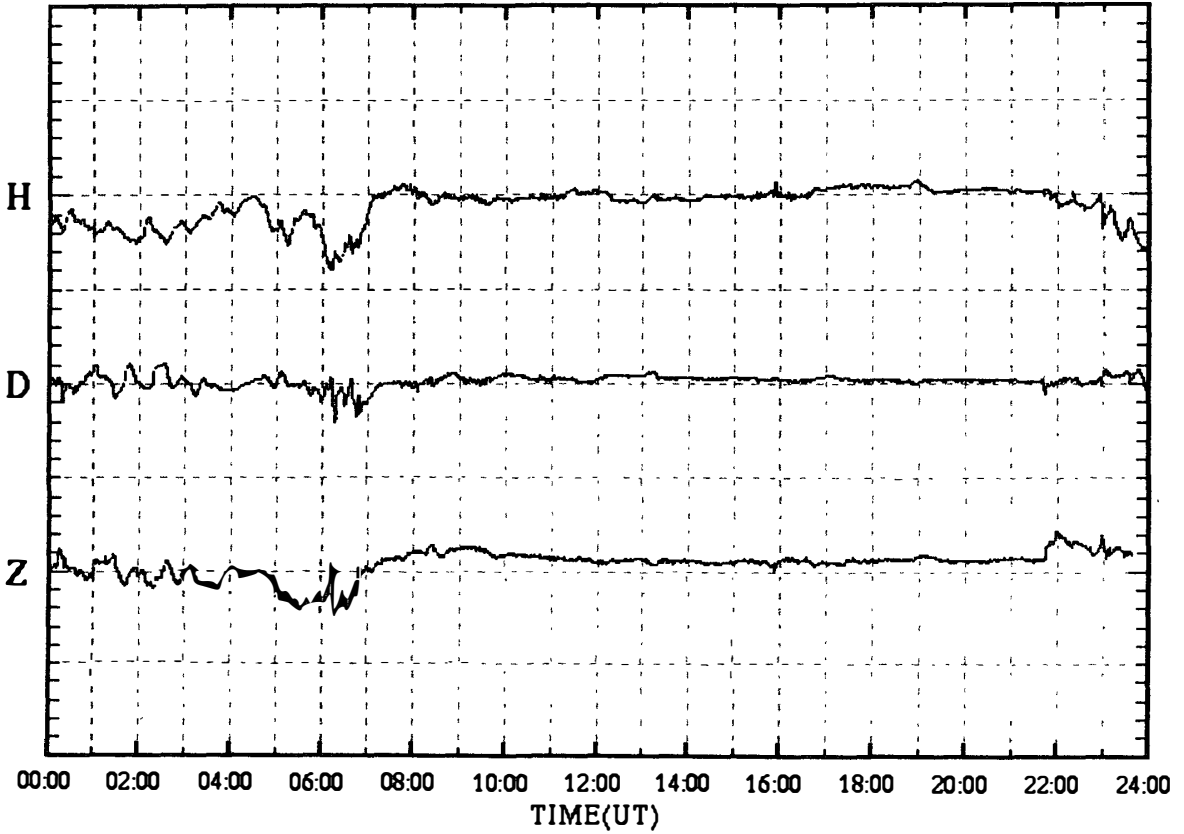

SYOWA magnetogram (100 nT/div)

13 Mar.2000 (DAY:073)

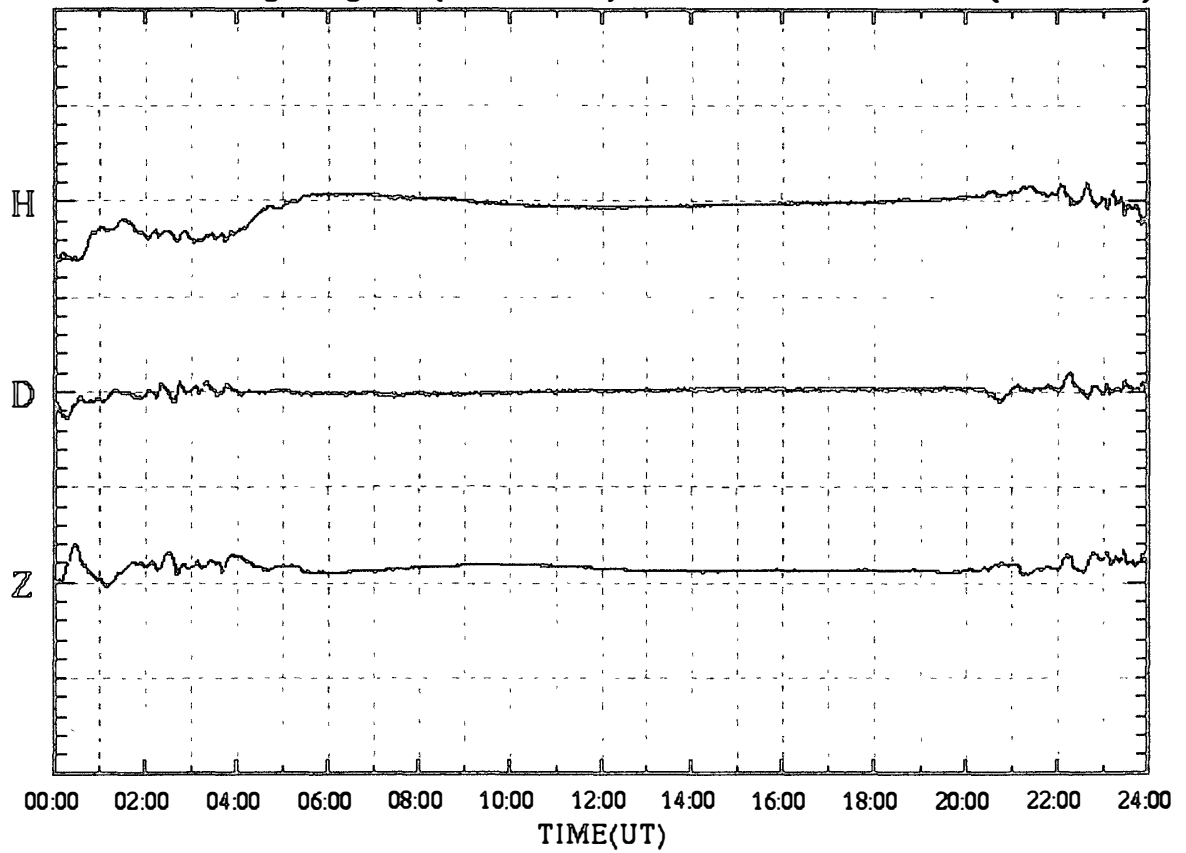

SYOWA magnetogram (100 nT/div)

14 Mar.2000 (DAY:074)

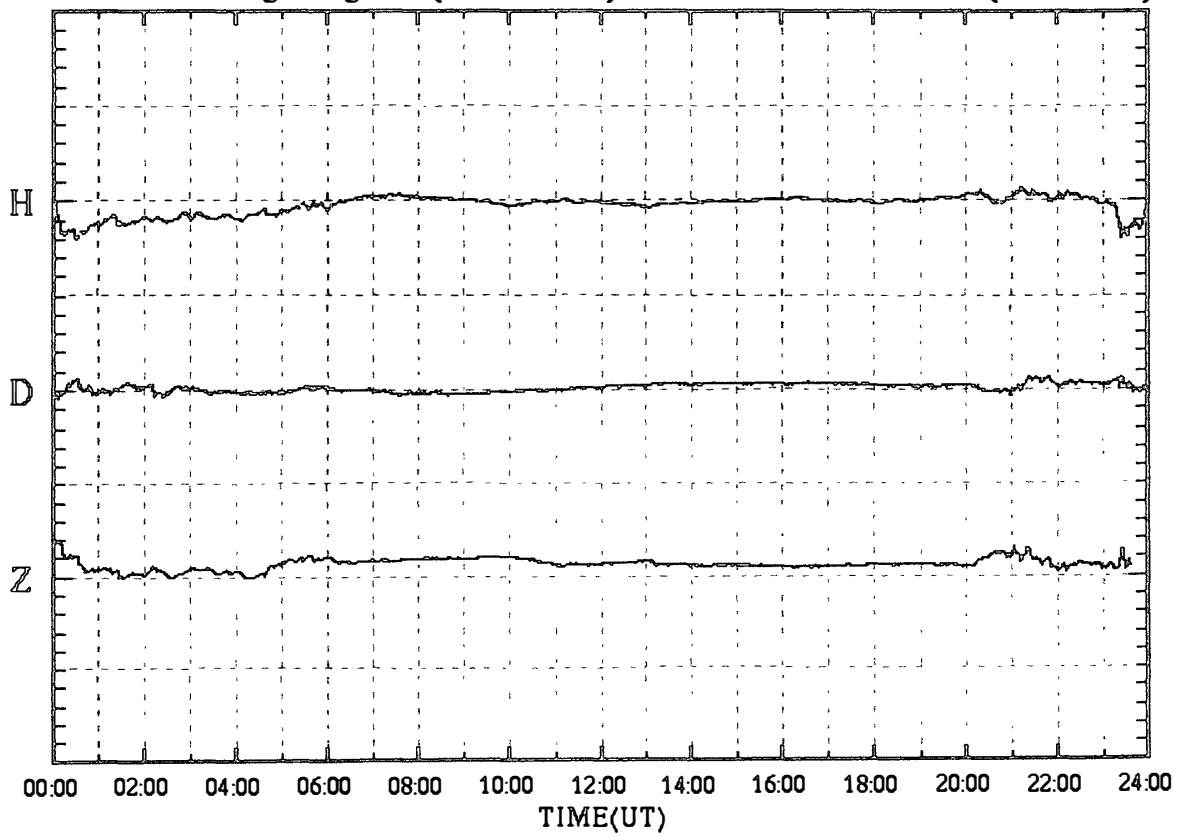

SYOWA magnetogram (100 nT/div)

15 Mar.2000 (DAY:075)

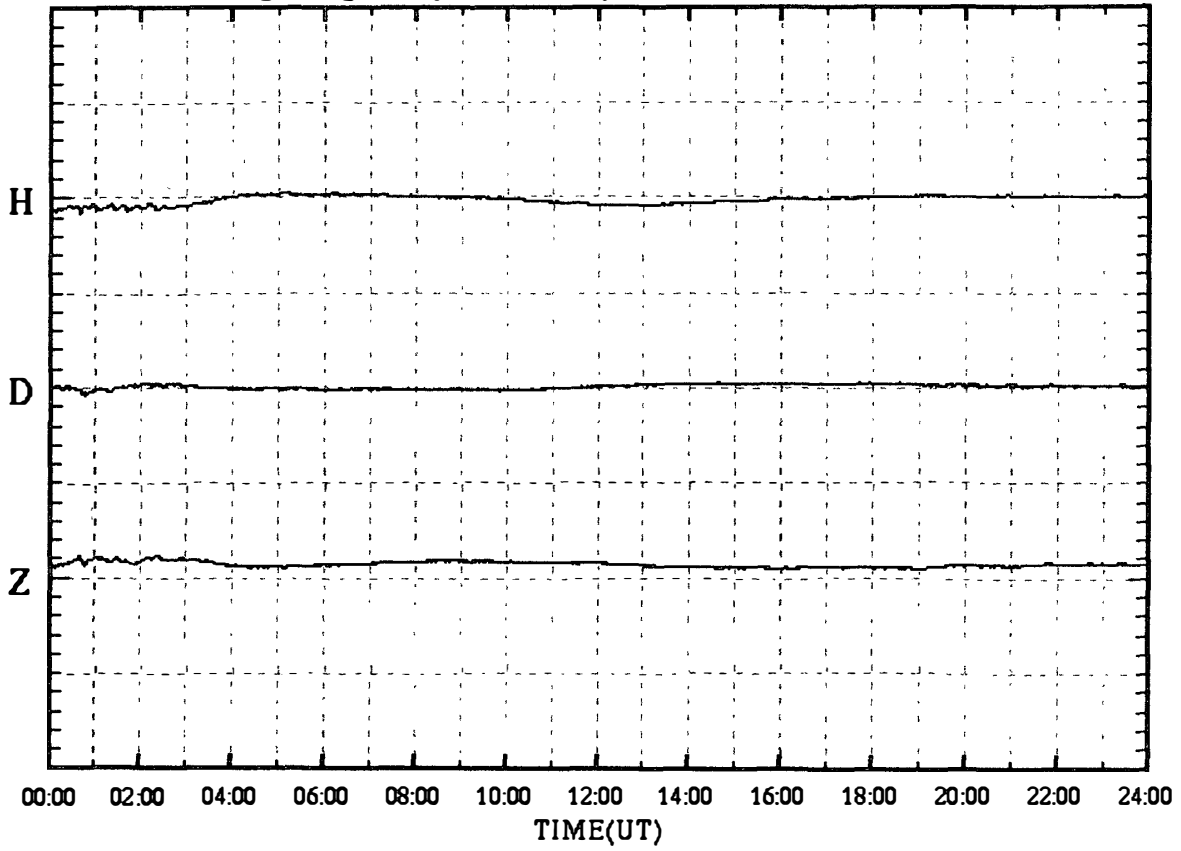

SYOWA magnetogram (100 nT/div)

16 Mar.2000 (DAY:076)

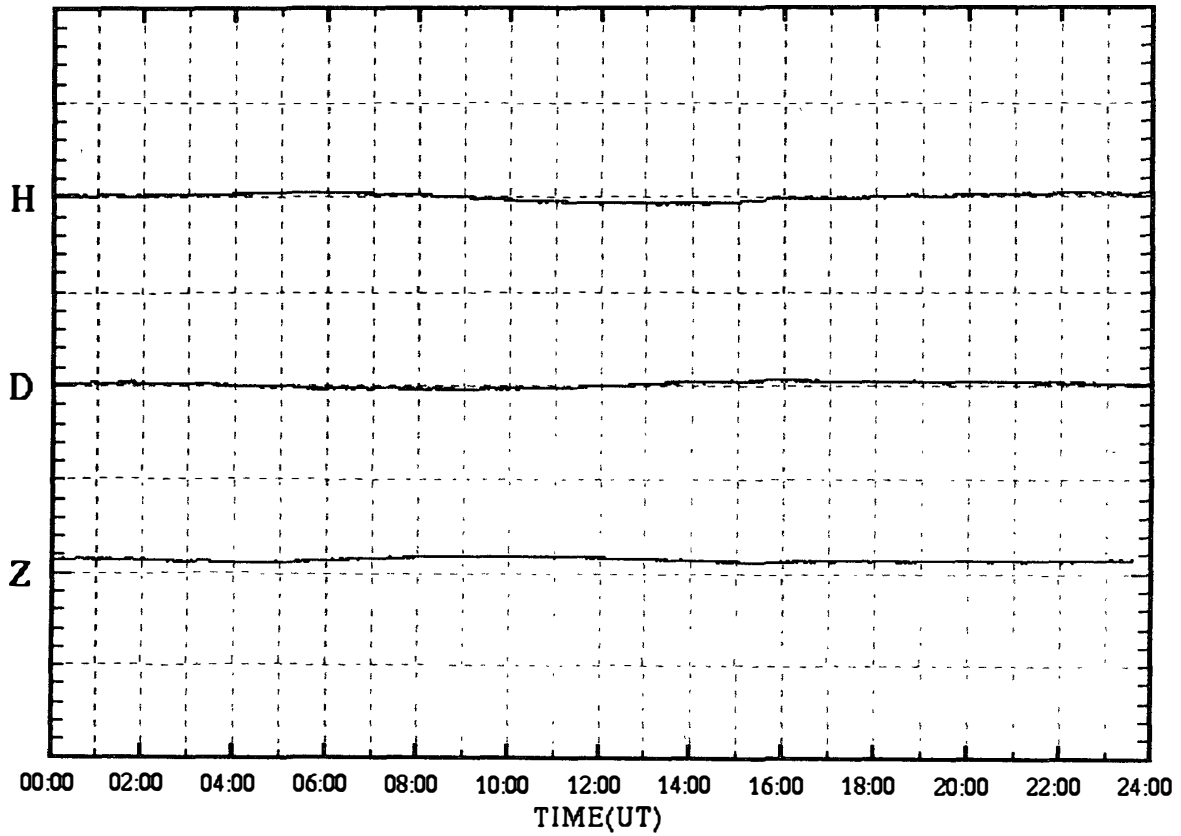

SYOWA magnetogram (100 nT/div)

17 Mar.2000 (DAY:077)

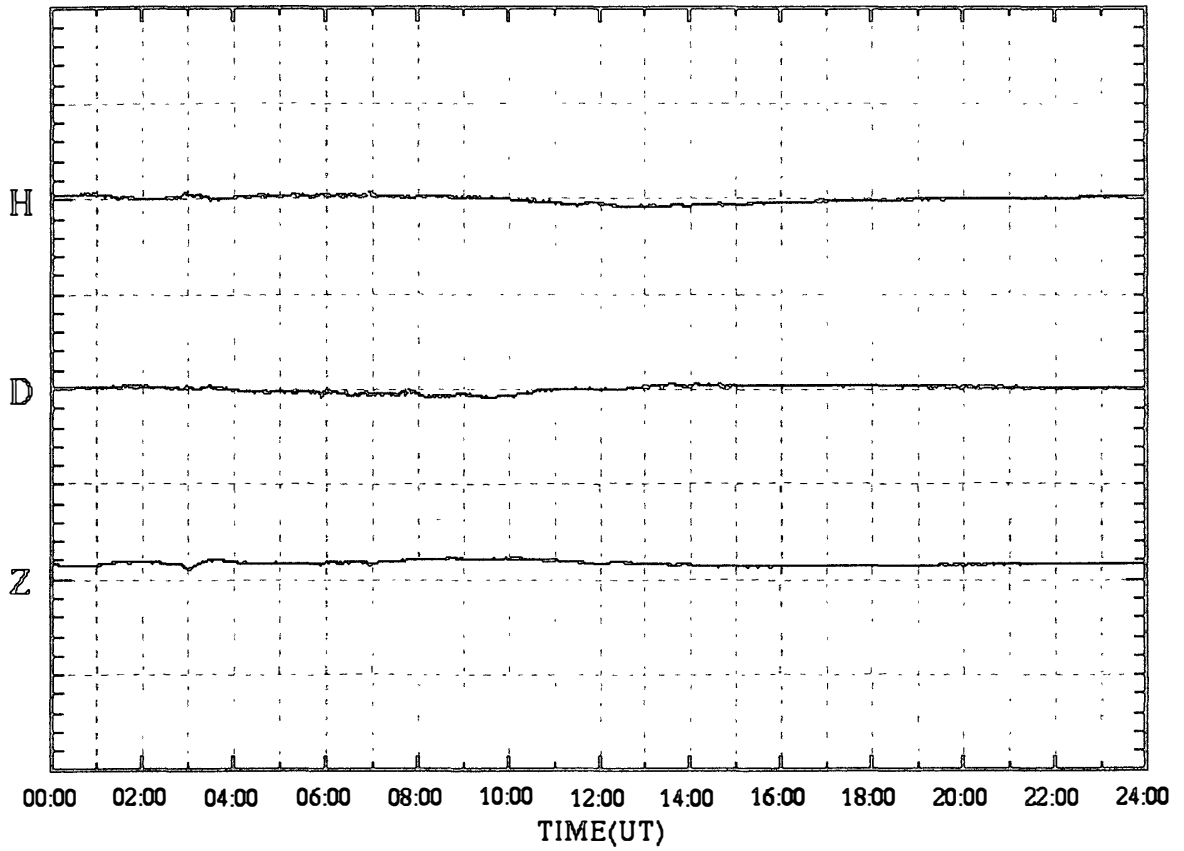

SYOWA magnetogram (100 nT/div)

18 Mar.2000 (DAY:078)

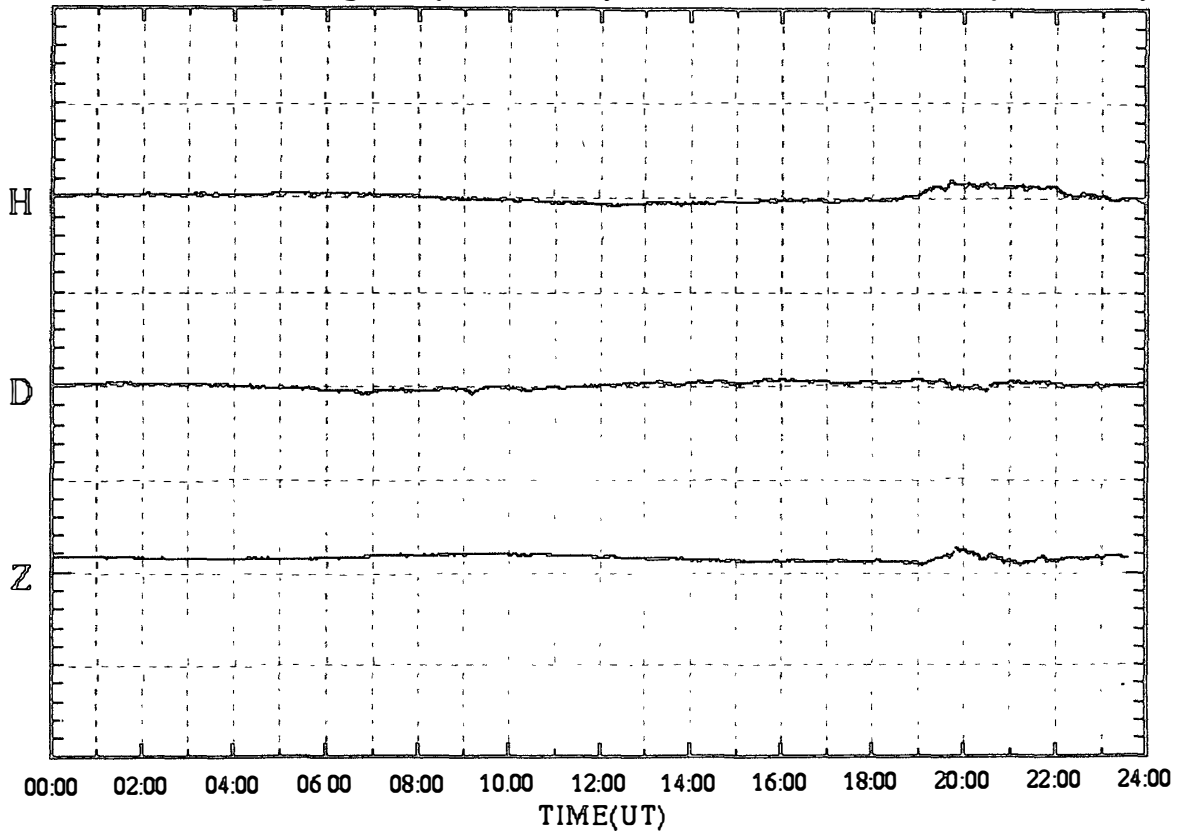

SYOWA magnetogram (100 nT/div)

19 Mar.2000 (DAY:079)

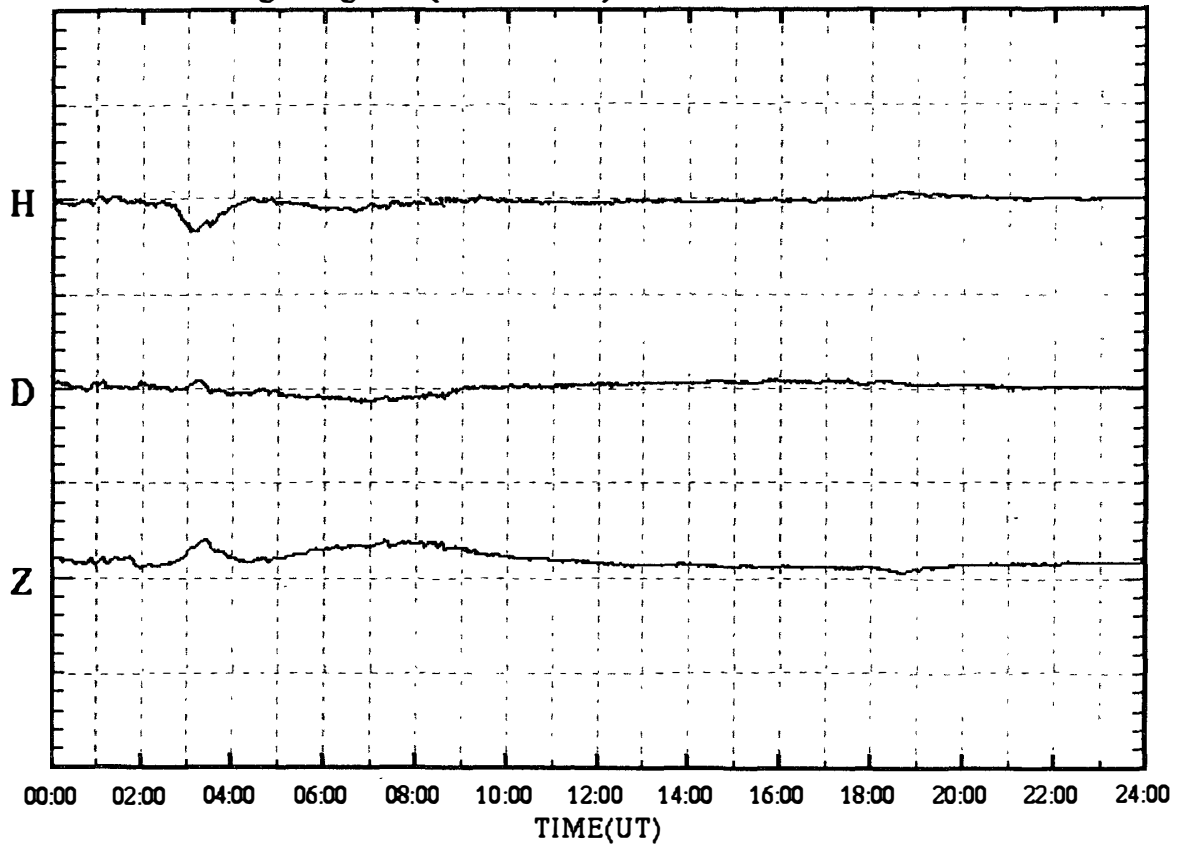

SYOWA magnetogram (100 nT/div)

20 Mar.2000 (DAY:080)

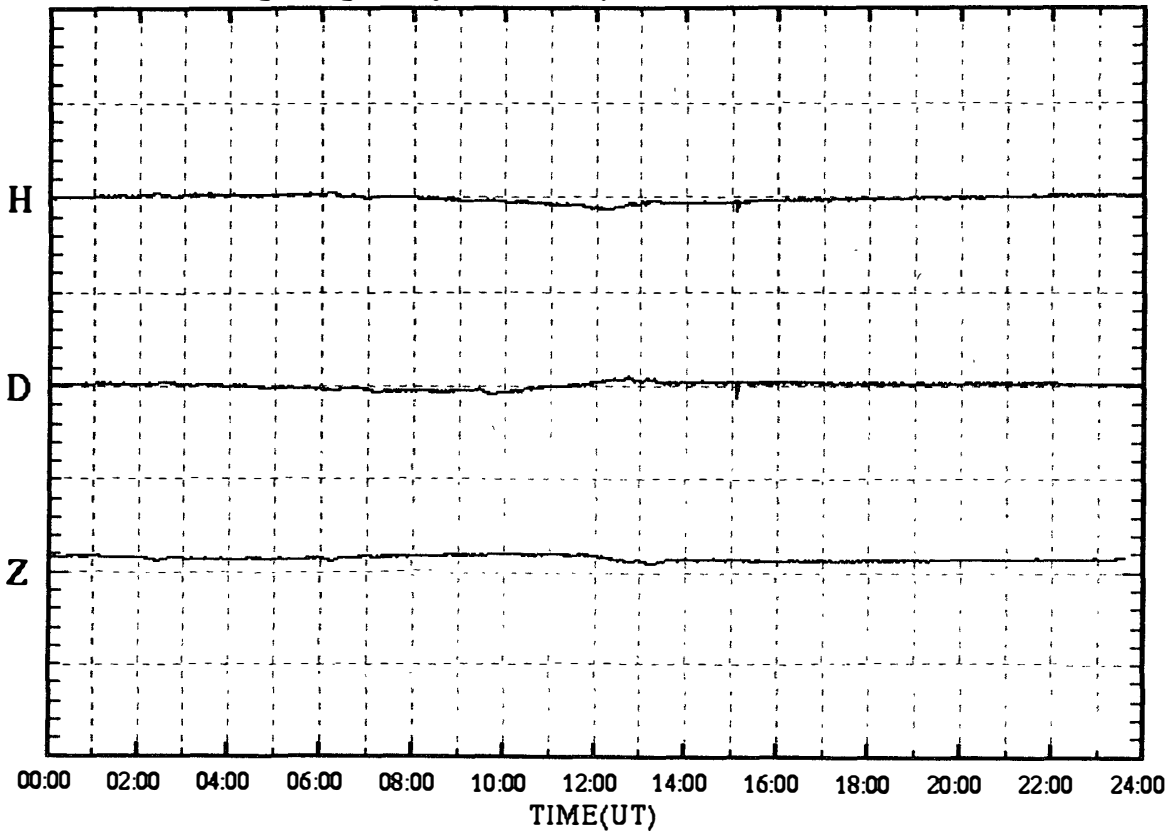

SYOWA magnetogram (100 nT/div)

21 Mar.2000 (DAY:081)

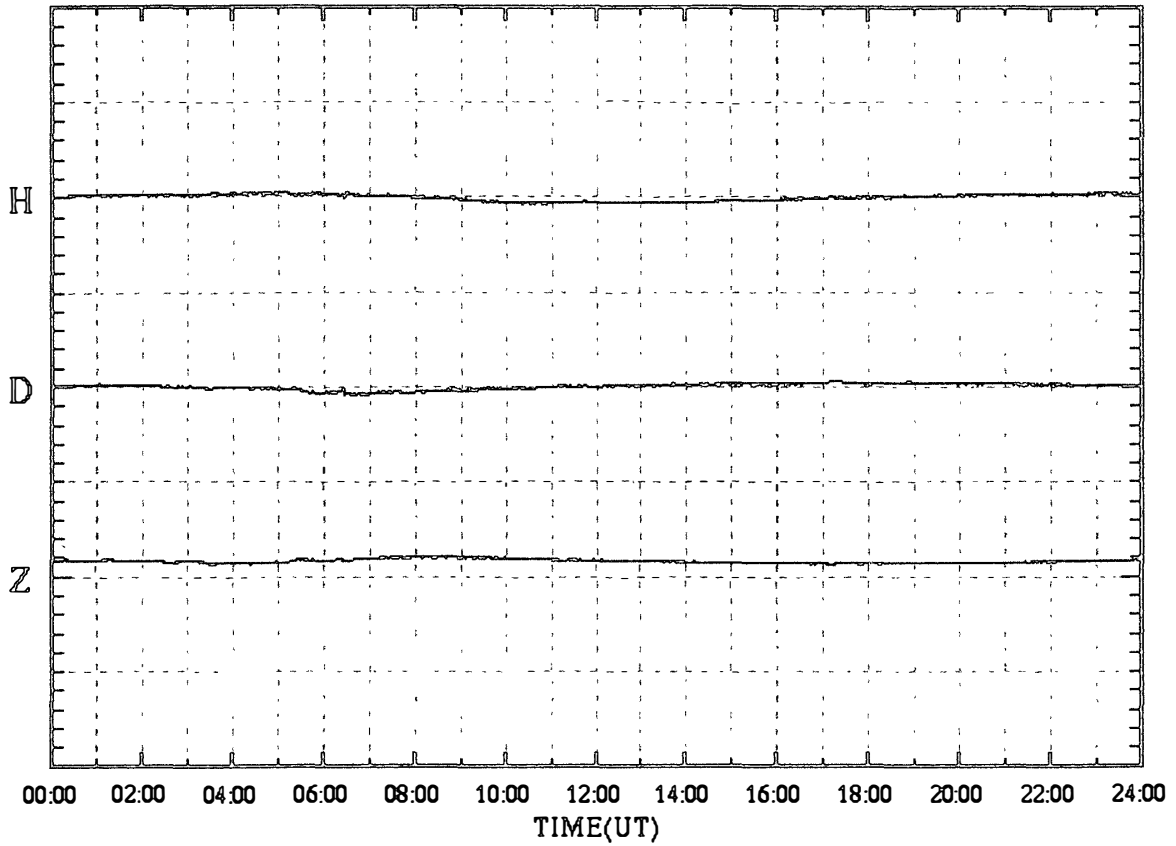

SYOWA magnetogram (100 nT/div)

22 Mar.2000 (DAY:082)

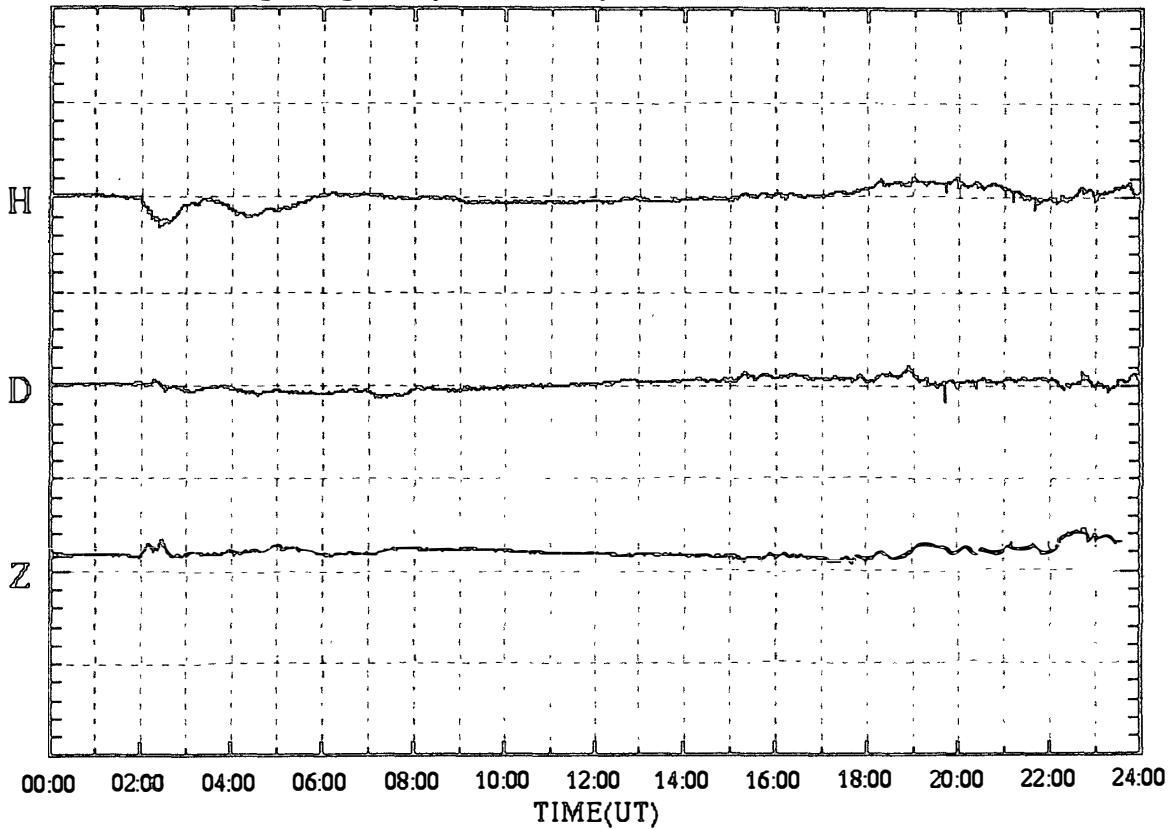

SYOWA magnetogram (100 nT/div)

23 Mar.2000 (DAY:083)

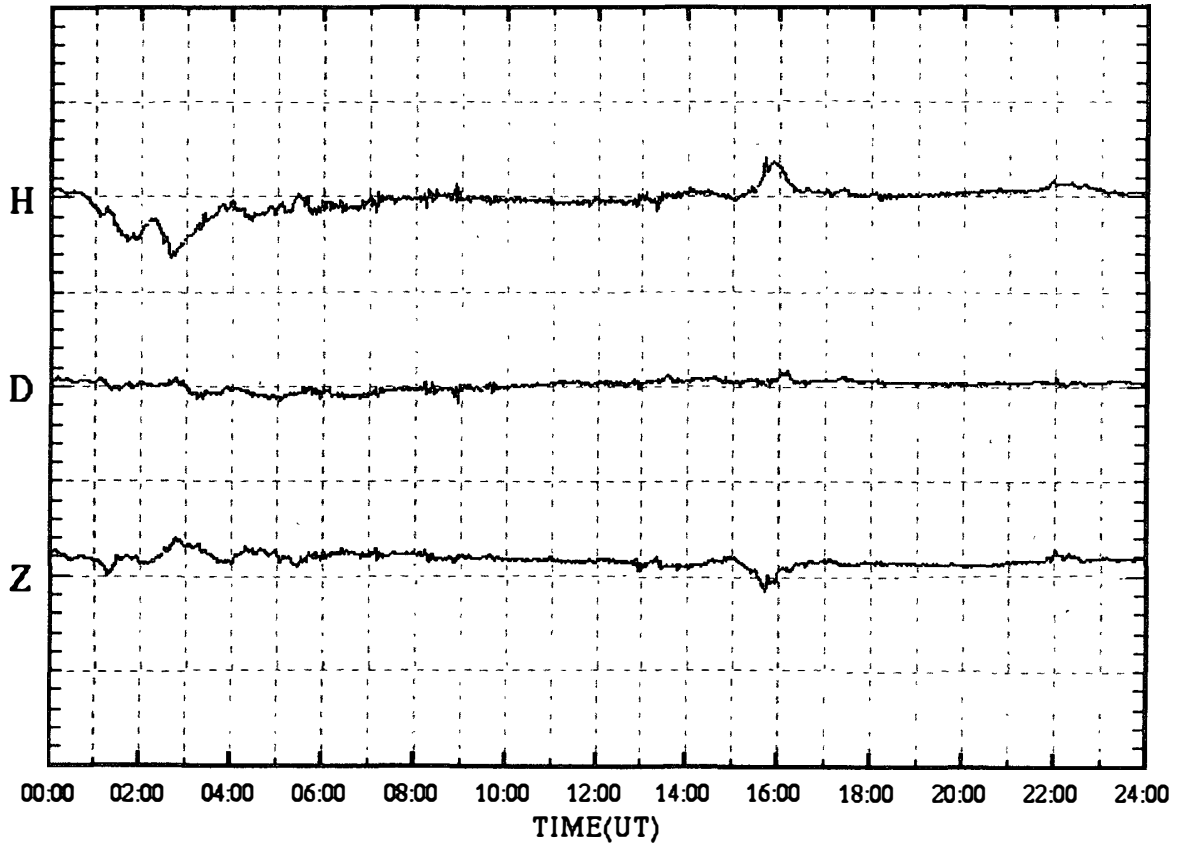

SYOWA magnetogram (100 nT/div)

24 Mar.2000 (DAY:084)

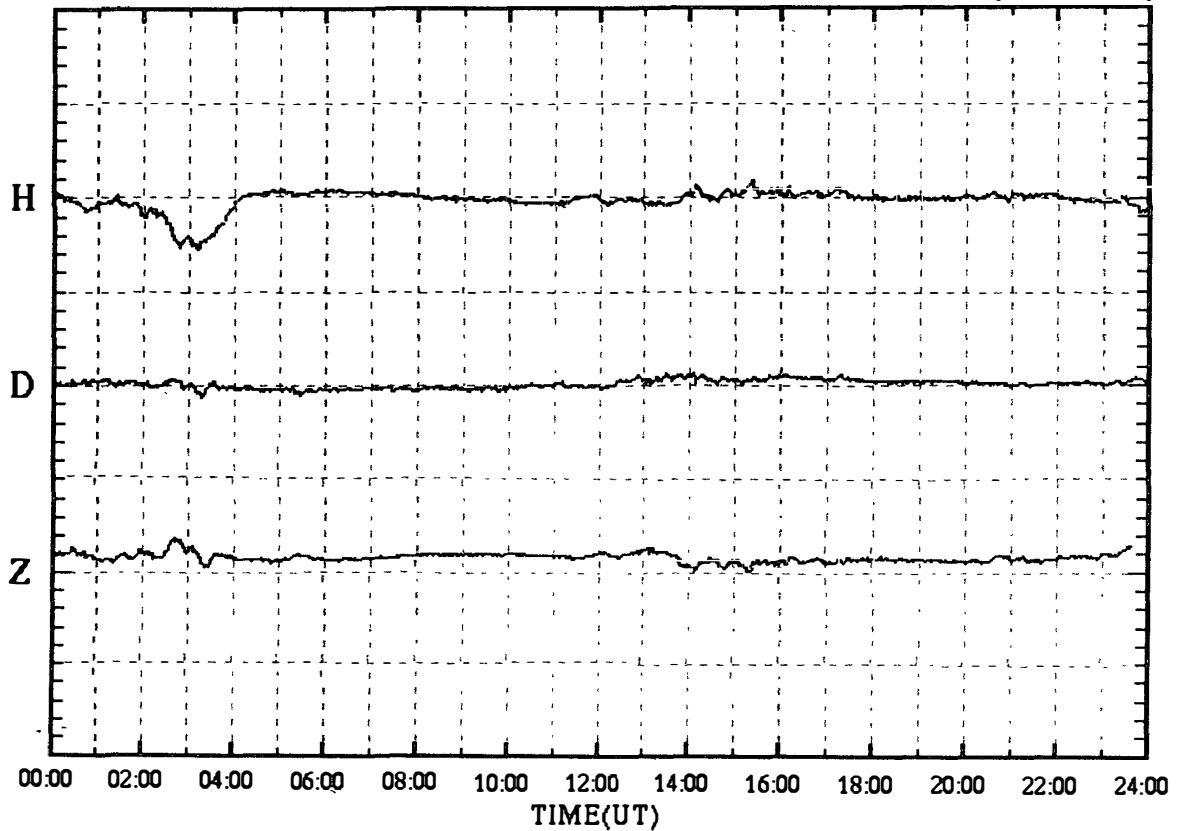

SYOWA magnetogram (100 nT/div)

25 Mar.2000 (DAY:085)

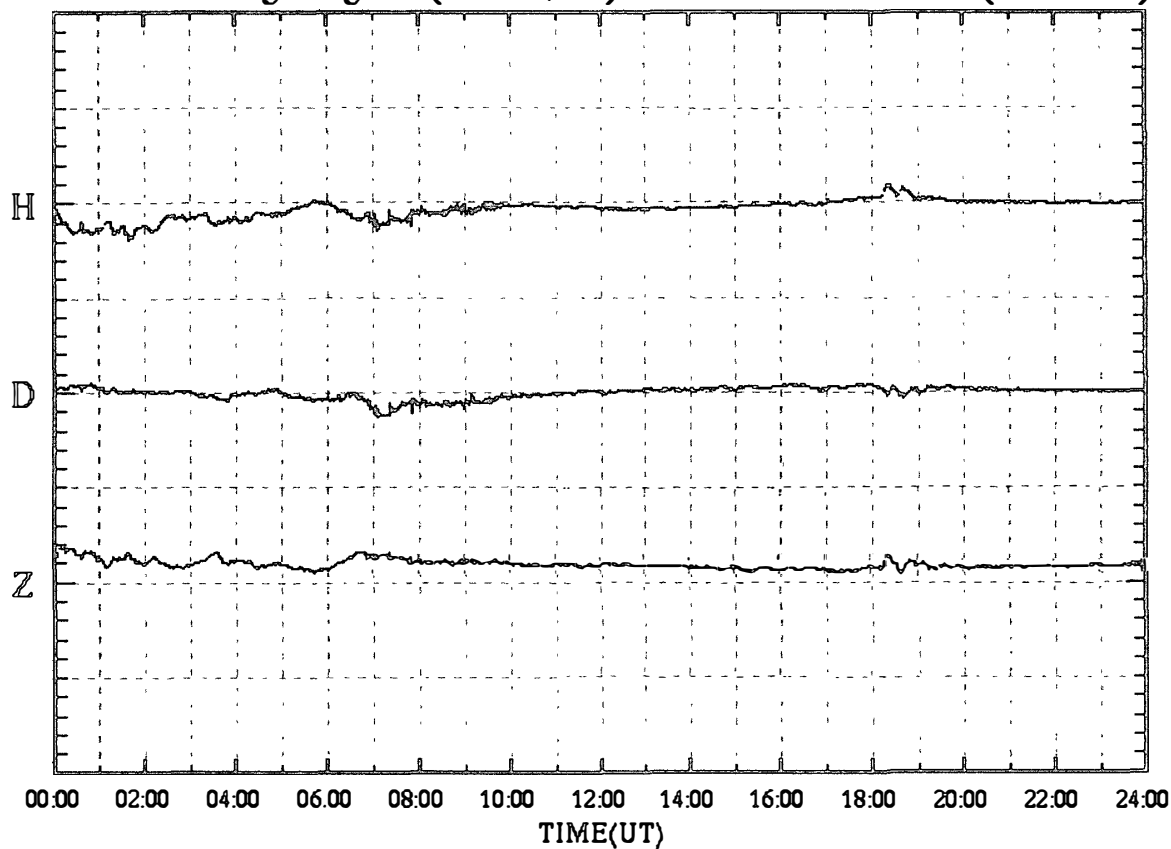

SYOWA magnetogram (100 nT/div)

26 Mar.2000 (DAY:086)

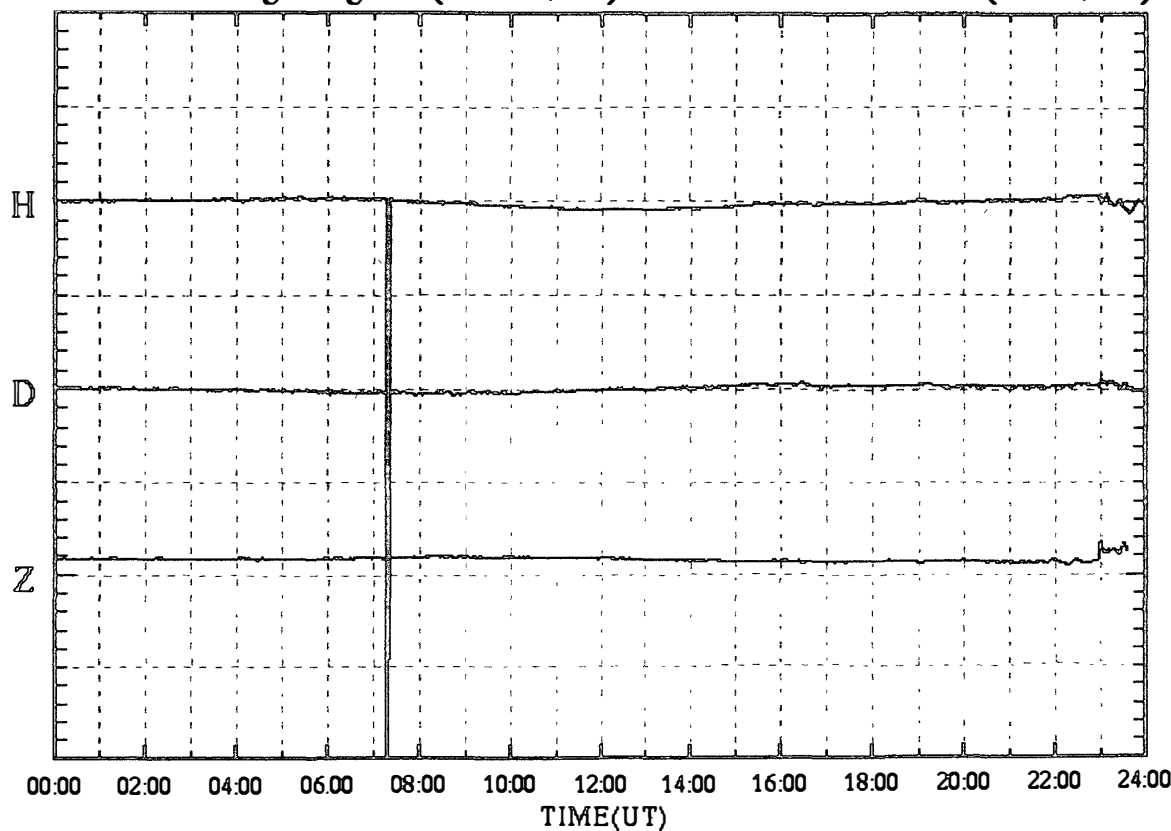

SYOWA magnetogram (100 nT/div)

27 Mar.2000 (DAY:087)

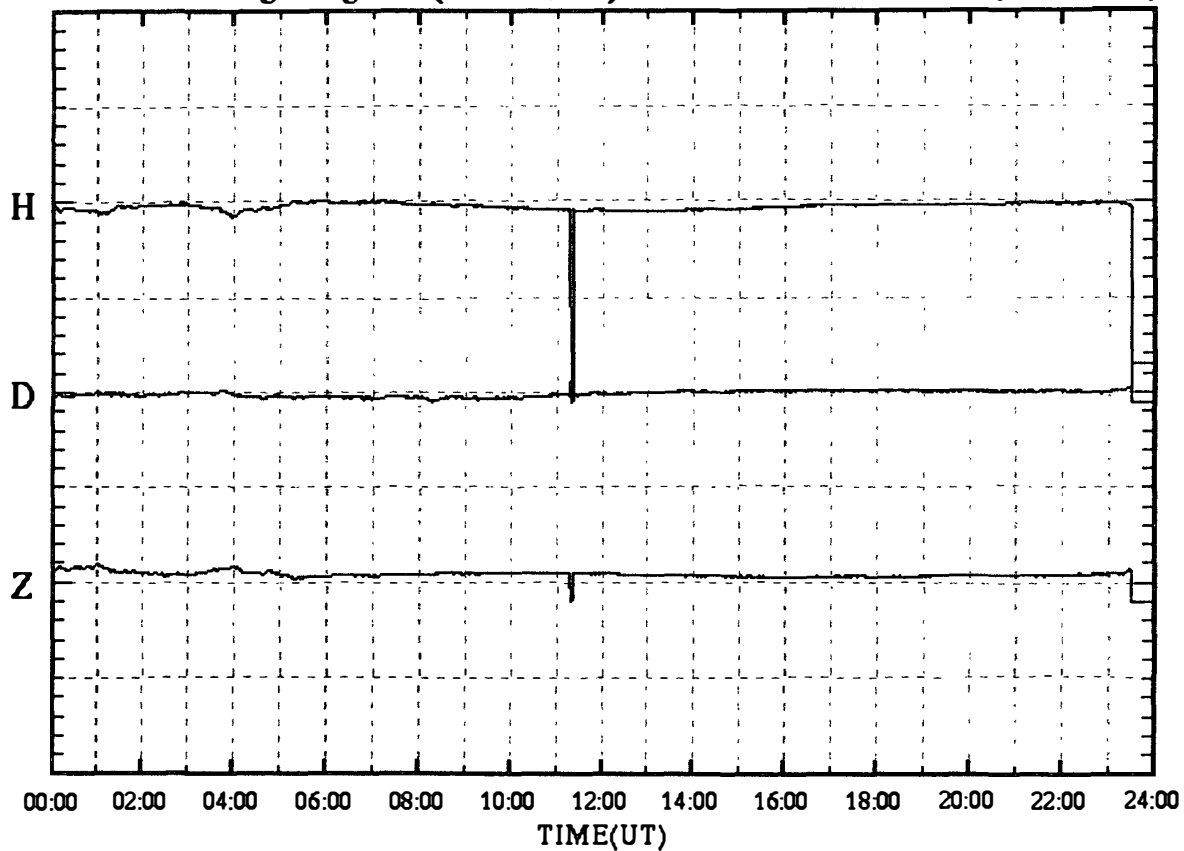

SYOWA magnetogram (100 nT/div)

28 Mar.2000 (DAY:088)

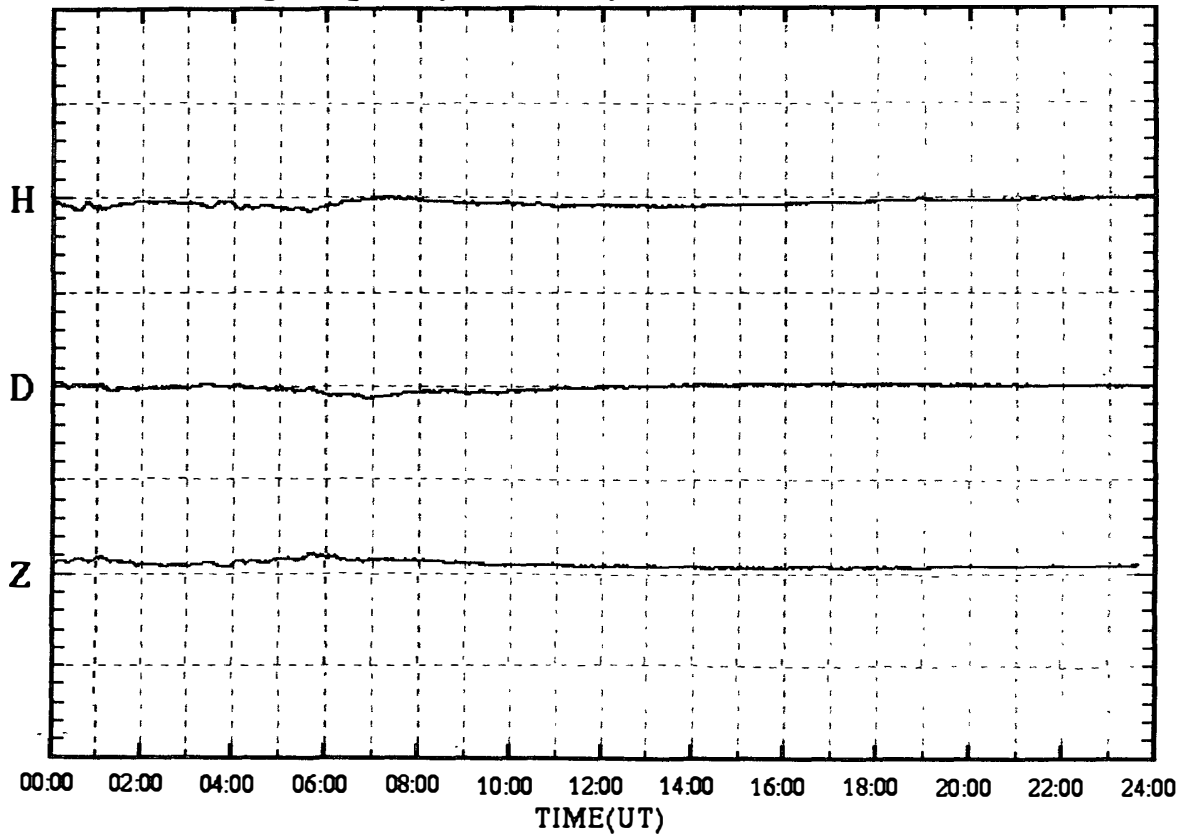

SYOWA magnetogram (100 nT/div)

29 Mar.2000 (DAY:089)

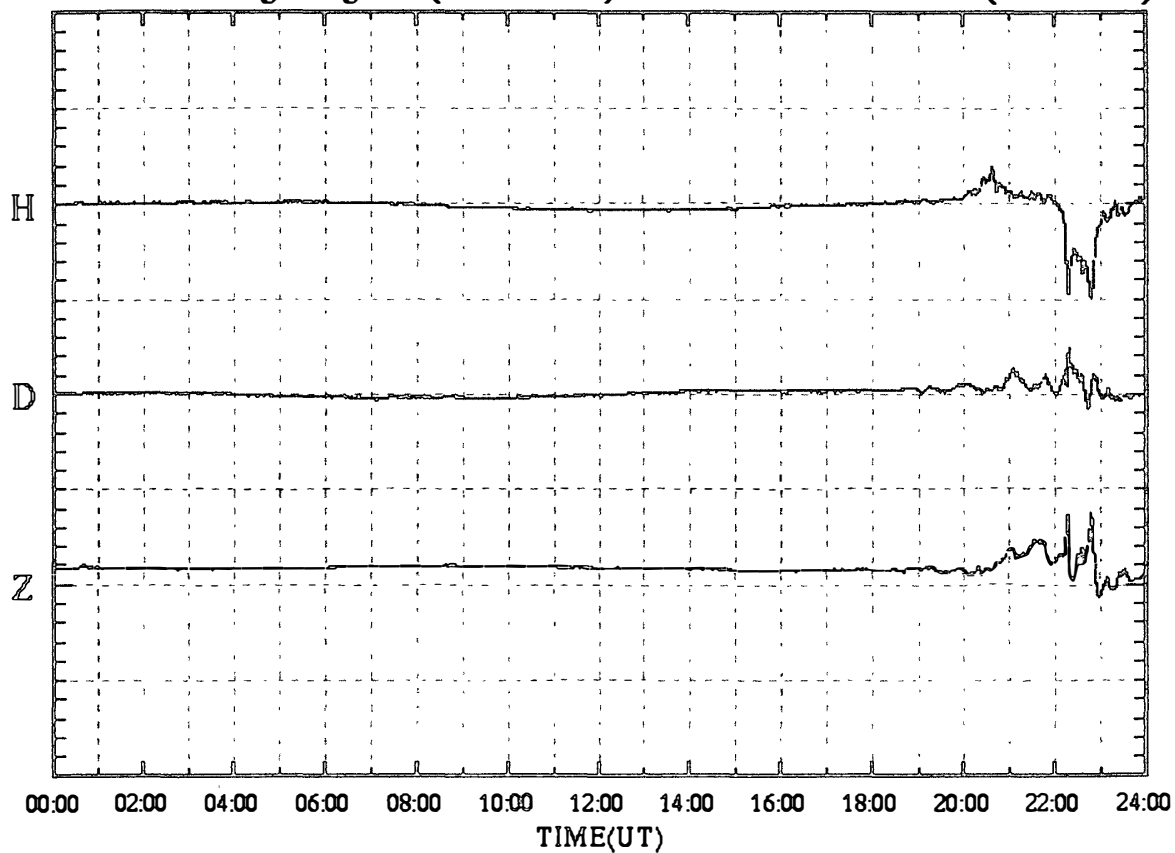

SYOWA magnetogram (100 nT/div)

30 Mar.2000 (DAY:090)

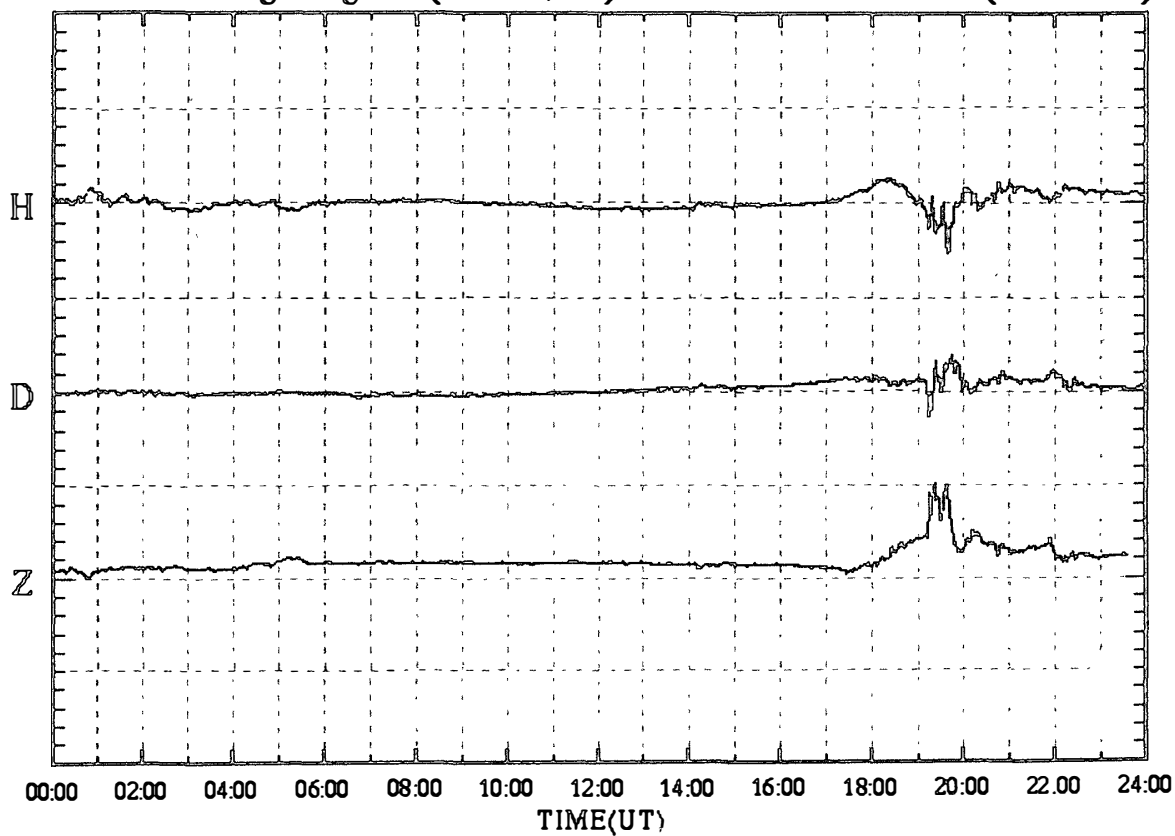

SYOWA magnetogram (100 nT/div)

31 Mar.2000 (DAY:091)

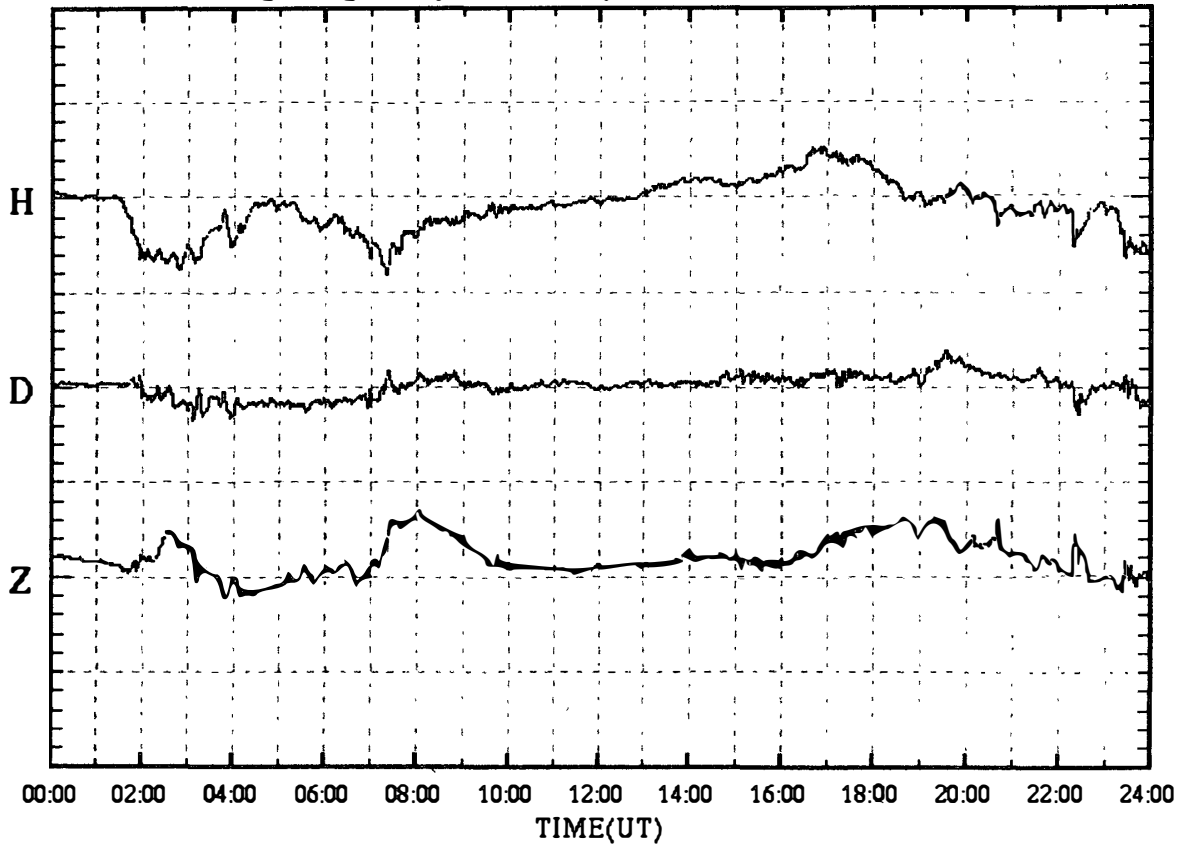

SYOWA magnetogram (100 nT/div)

01 Apr.2000 (DAY:092)

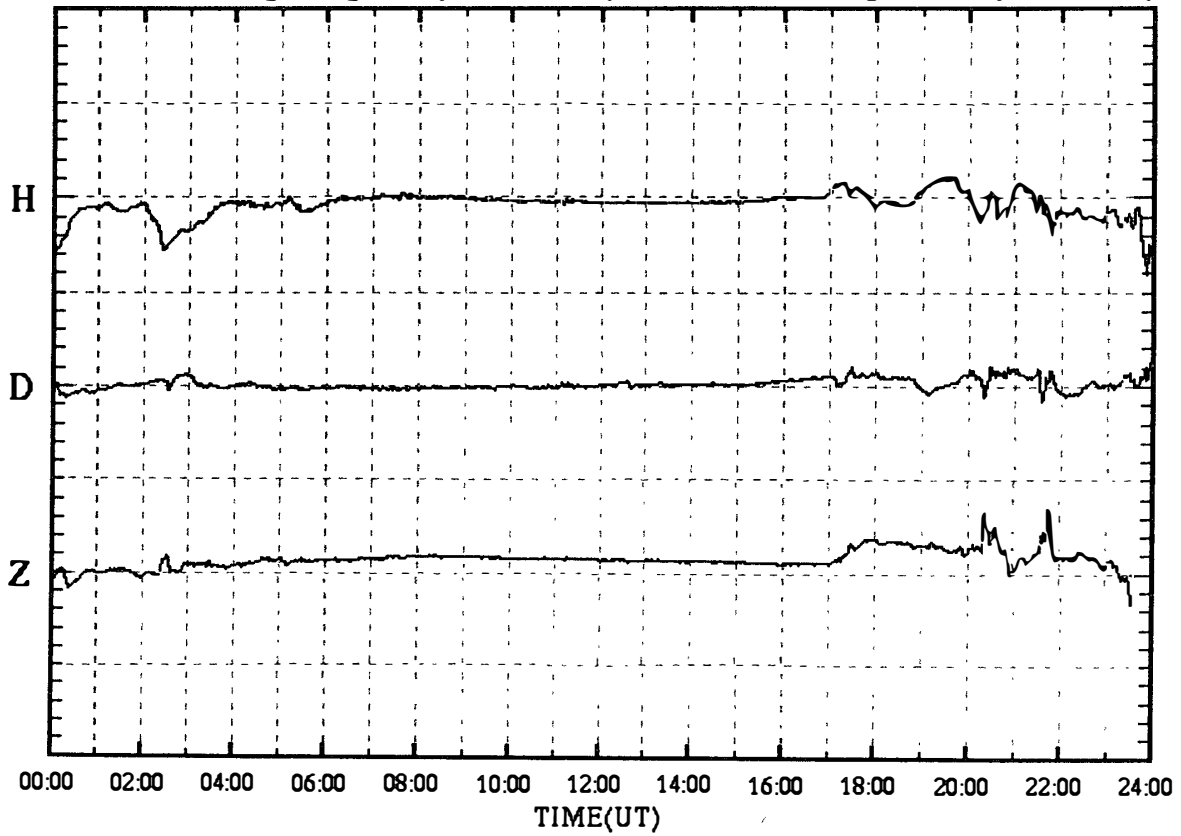

SYOWA magnetogram (100 nT/div)

02 Apr.2000 (DAY:093)

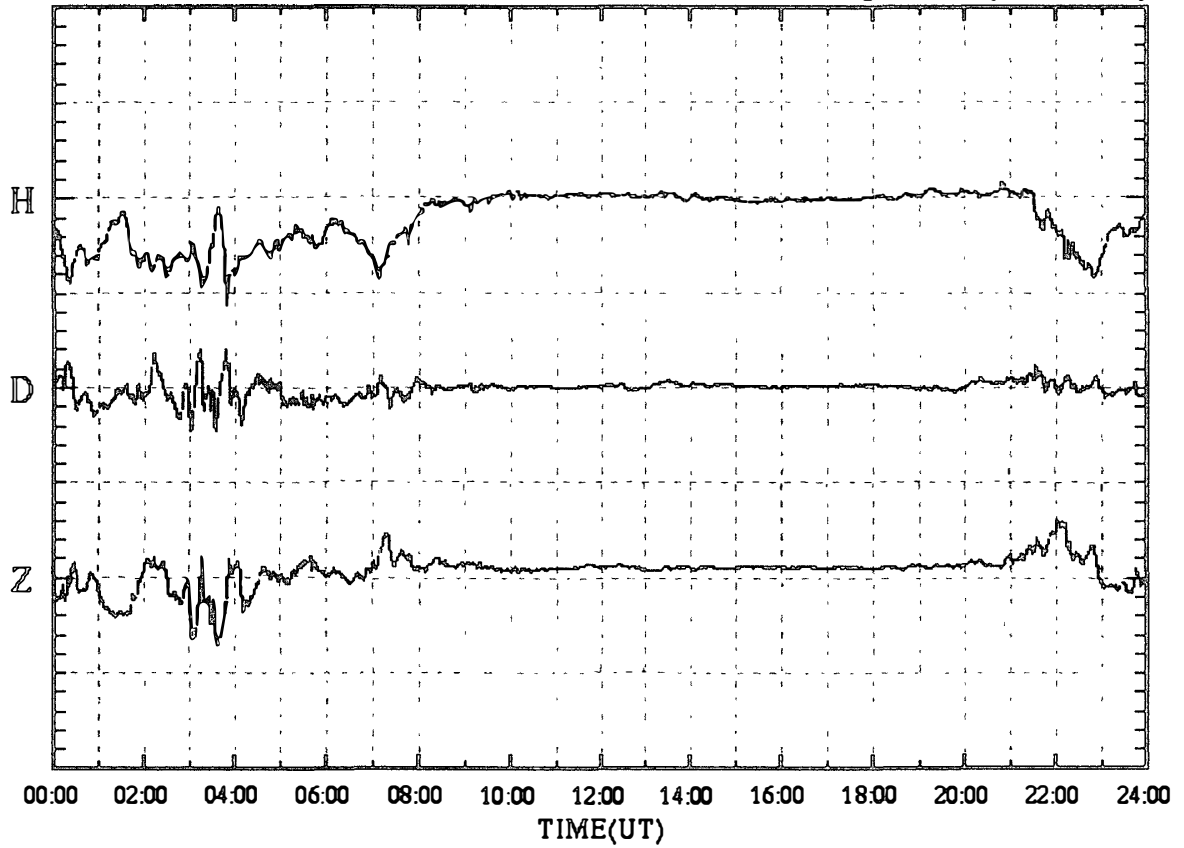

SYOWA magnetogram (100 nT/div)

03 Apr.2000 (DAY:094)

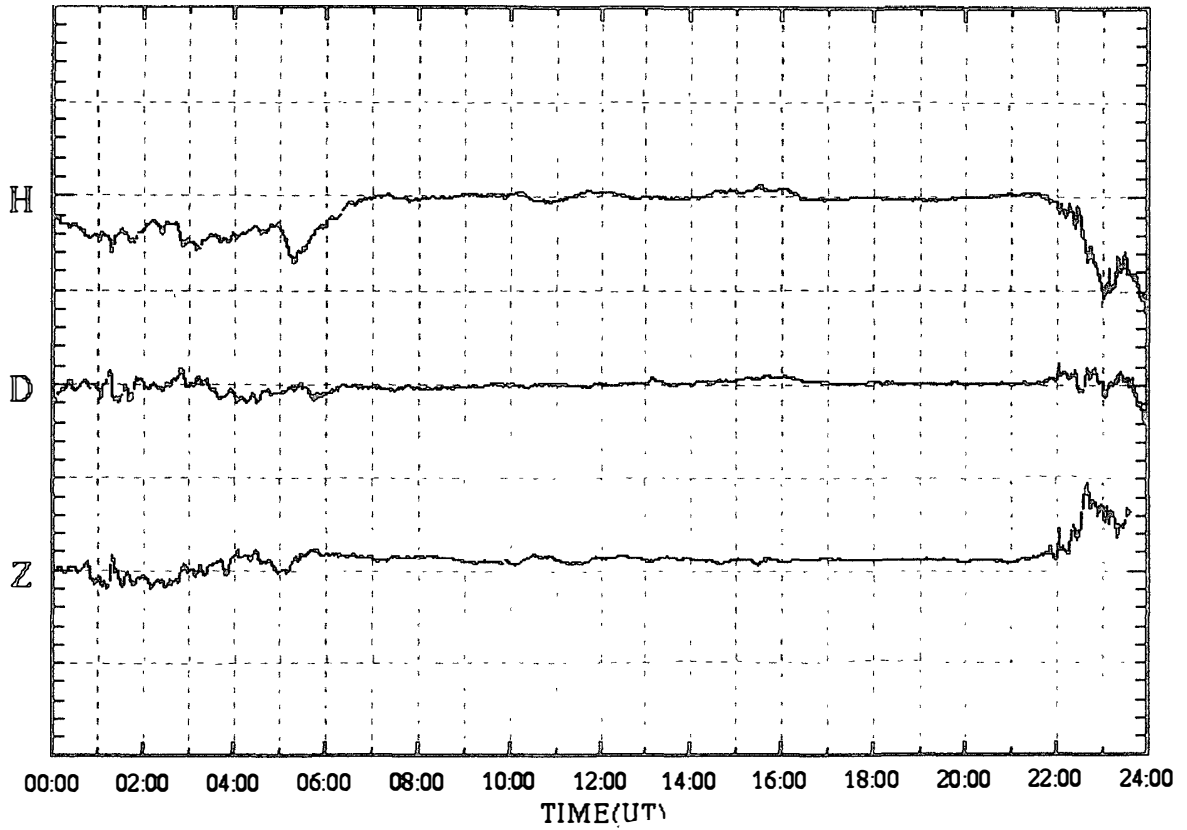

SYOWA magnetogram (100 nT/div)

04 Apr.2000 (DAY:095)

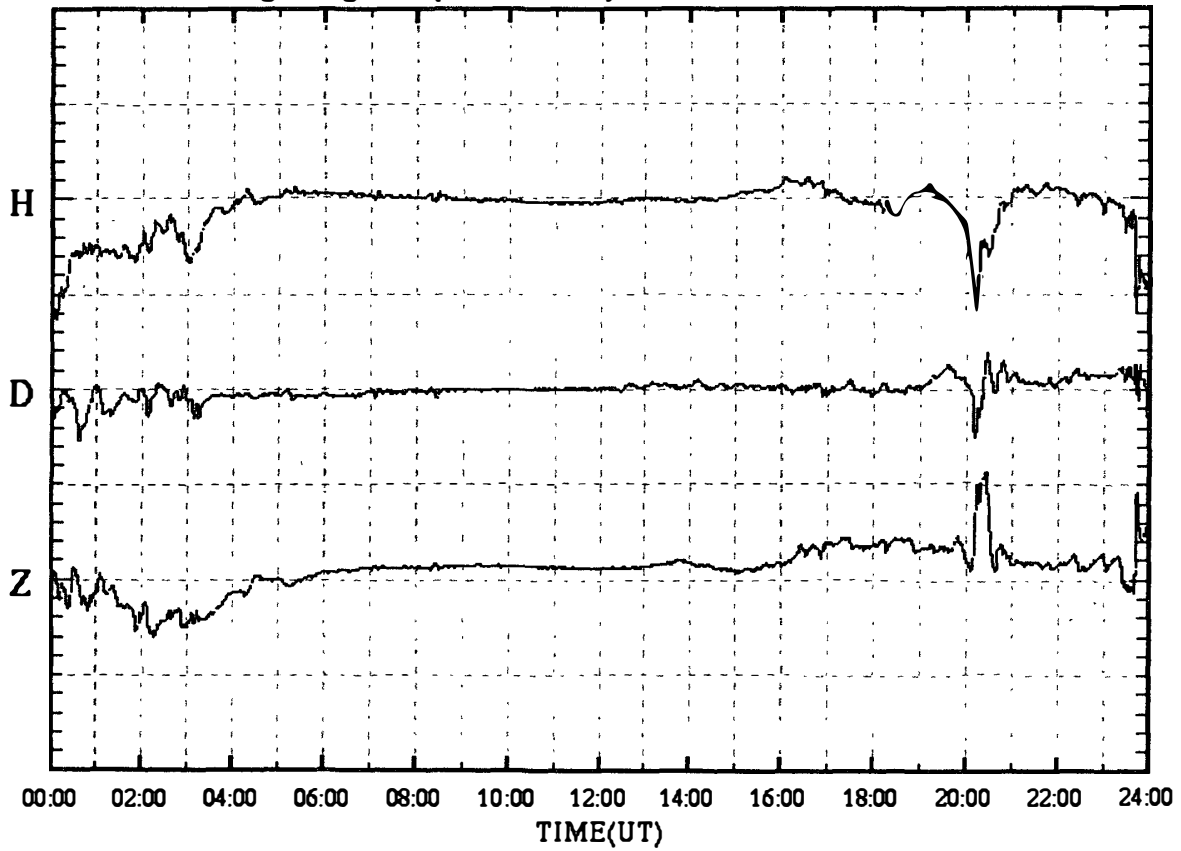

SYOWA magnetogram (100 nT/div)

05 Apr.2000 (DAY:096)

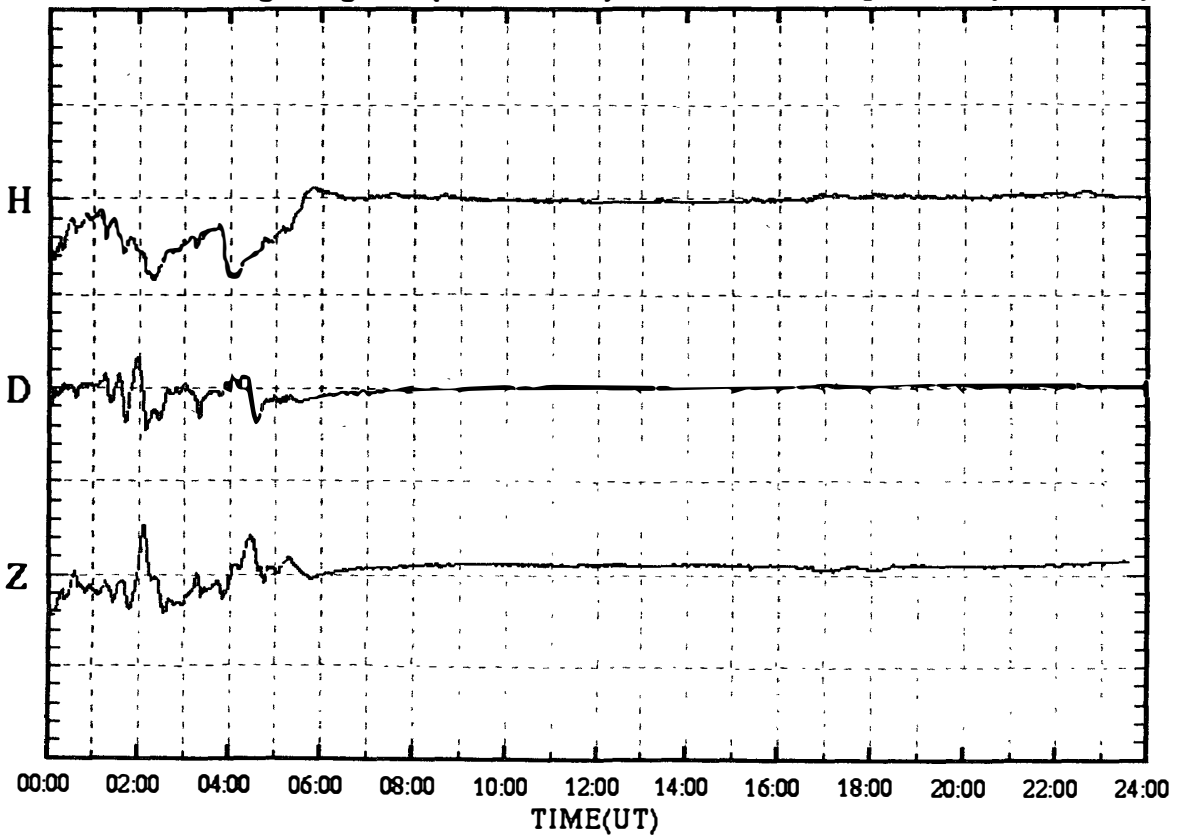

SYOWA magnetogram (100 nT/div)

06 Apr.2000 (DAY:097)

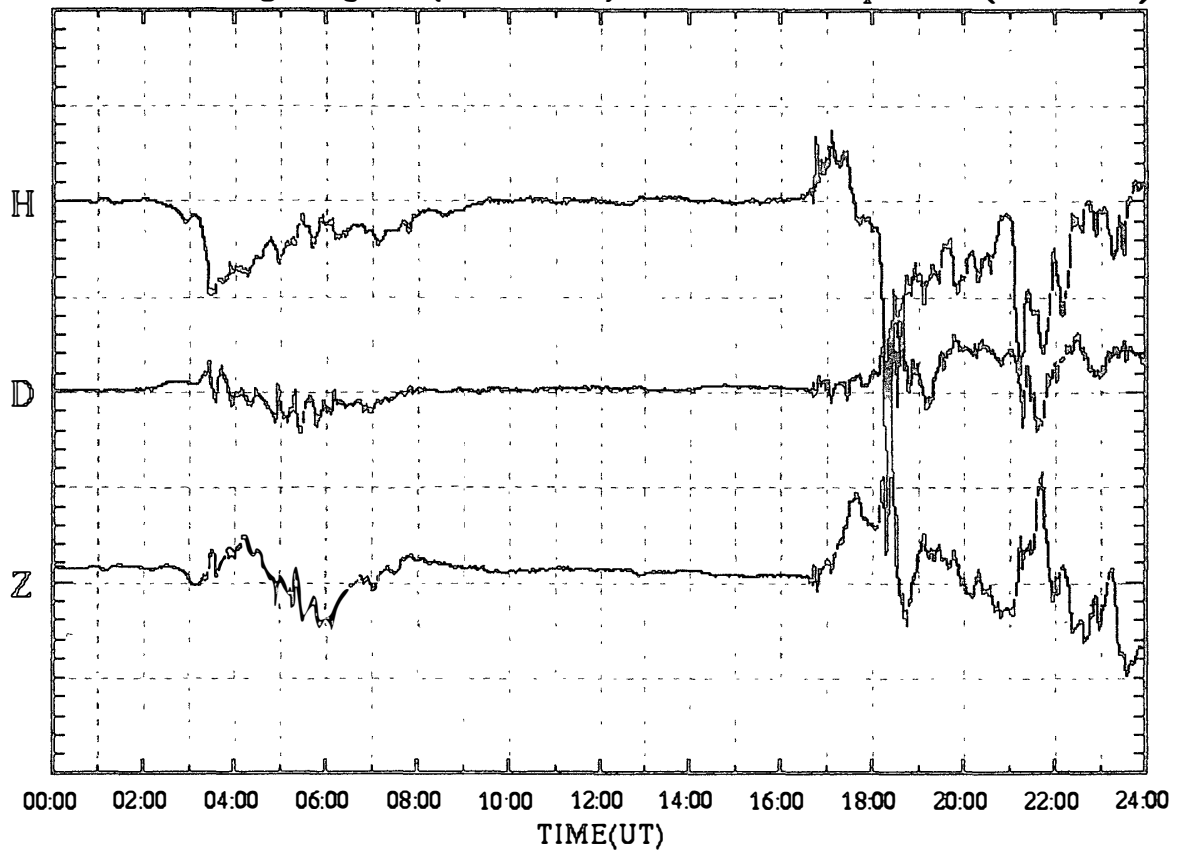

SYOWA magnetogram (100 nT/div)

07 Apr.2000 (DAY:098)

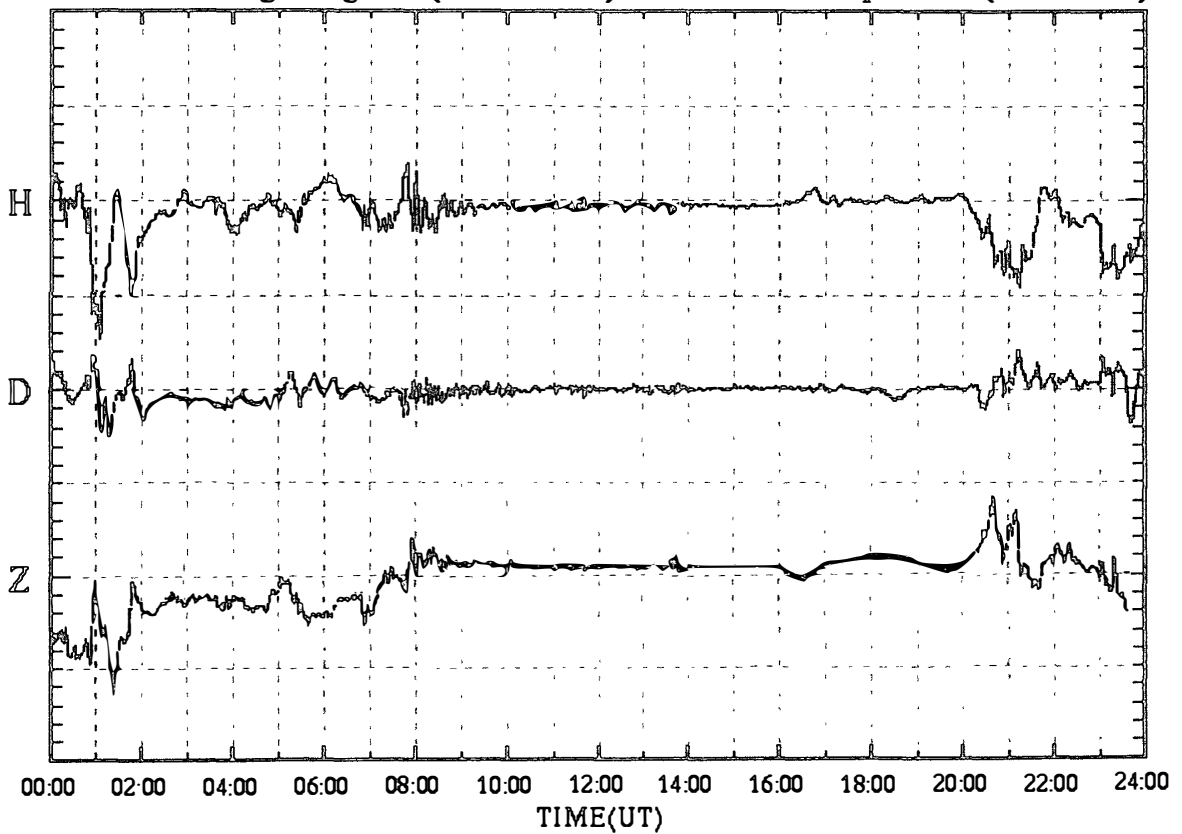

SYOWA magnetogram (100 nT/div)

08 Apr.2000 (DAY:099)

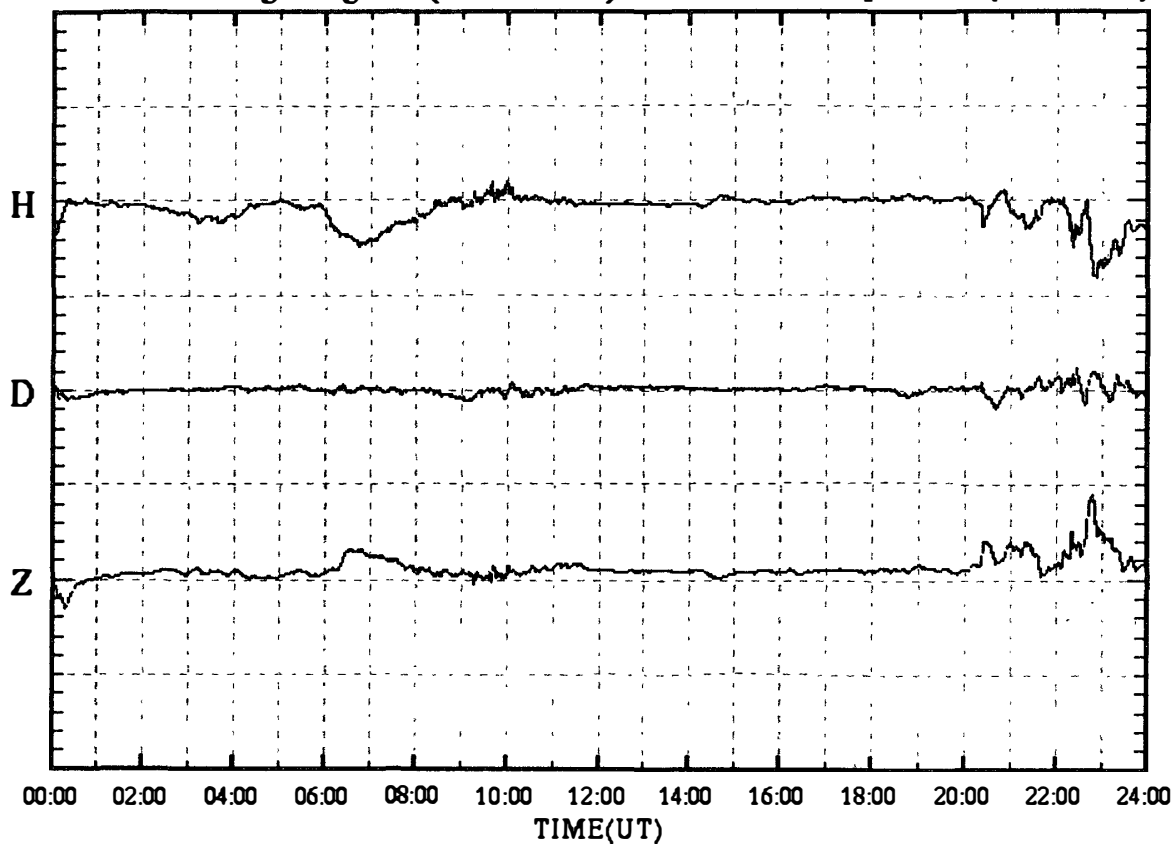

SYOWA magnetogram (100 nT/div)

09 Apr.2000 (DAY:100)

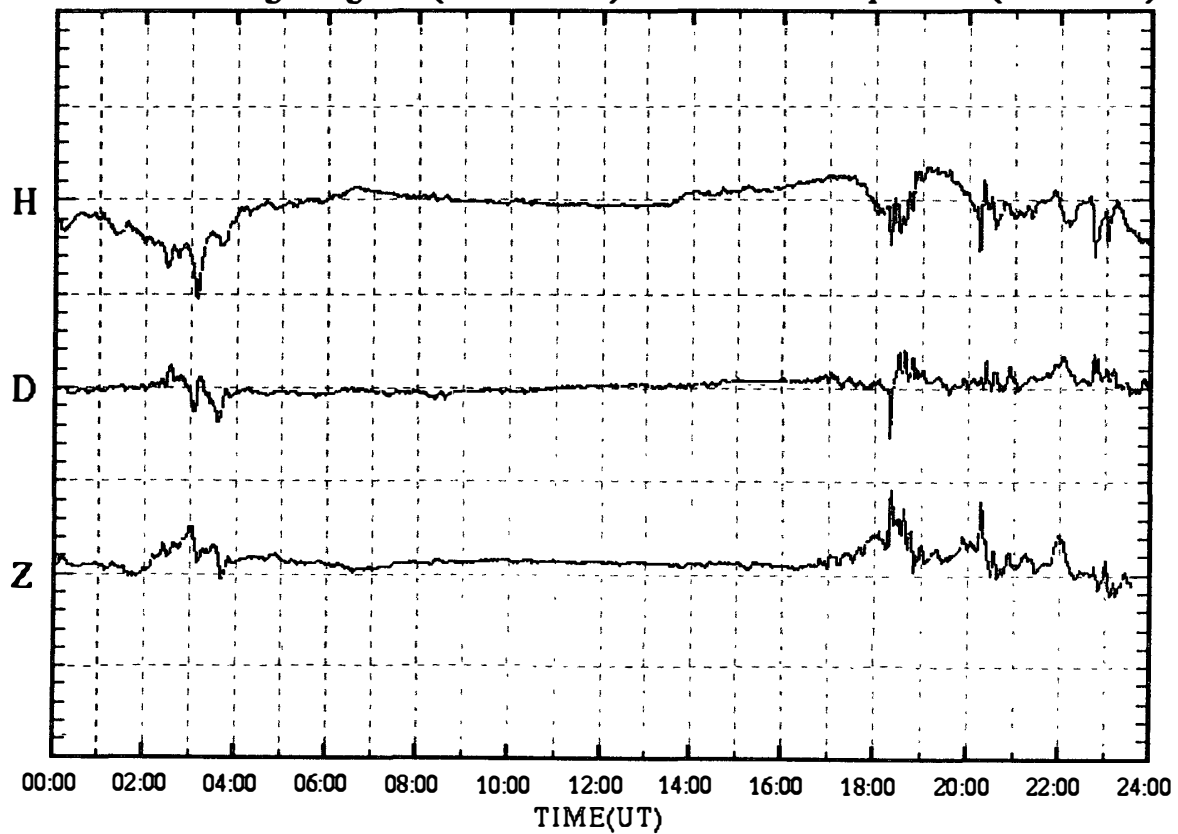

SYOWA magnetogram (100 nT/div)

10 Apr.2000 (DAY:101)

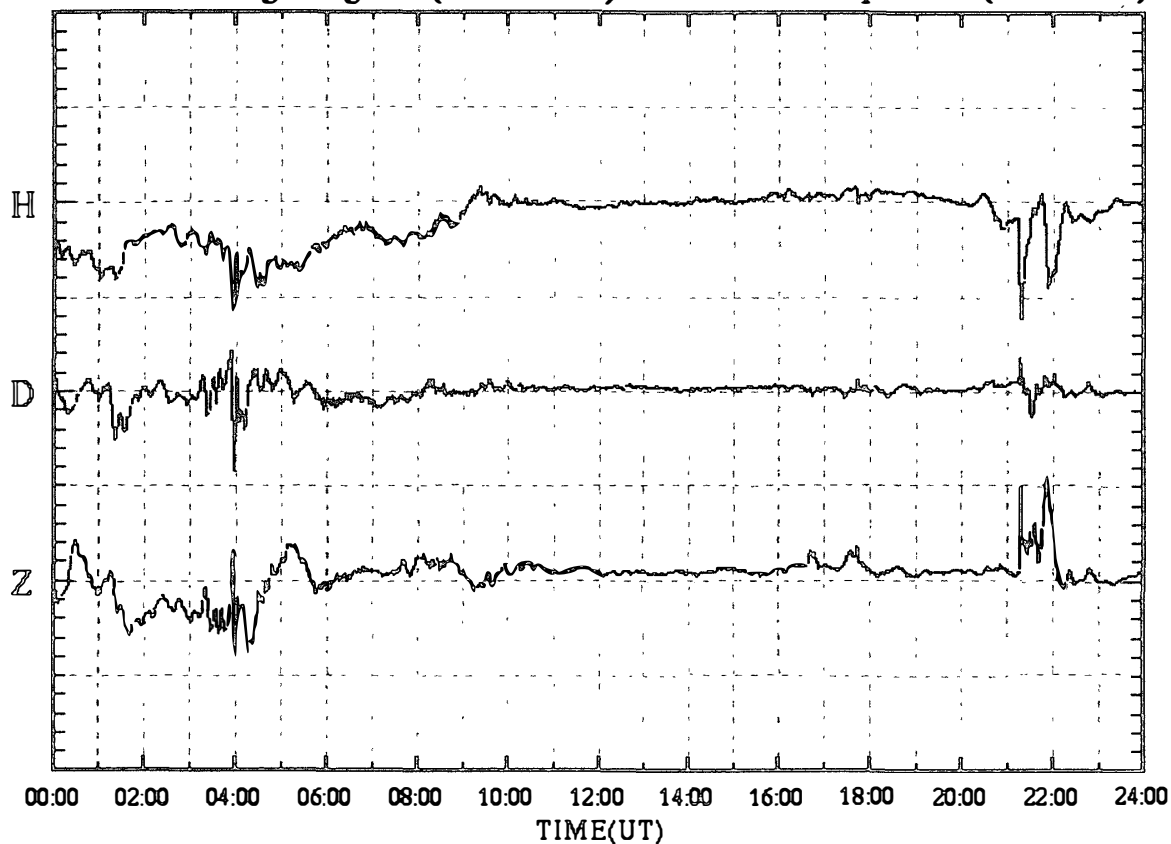

SYOWA magnetogram (100 nT/div)

11 Apr.2000 (DAY:102)

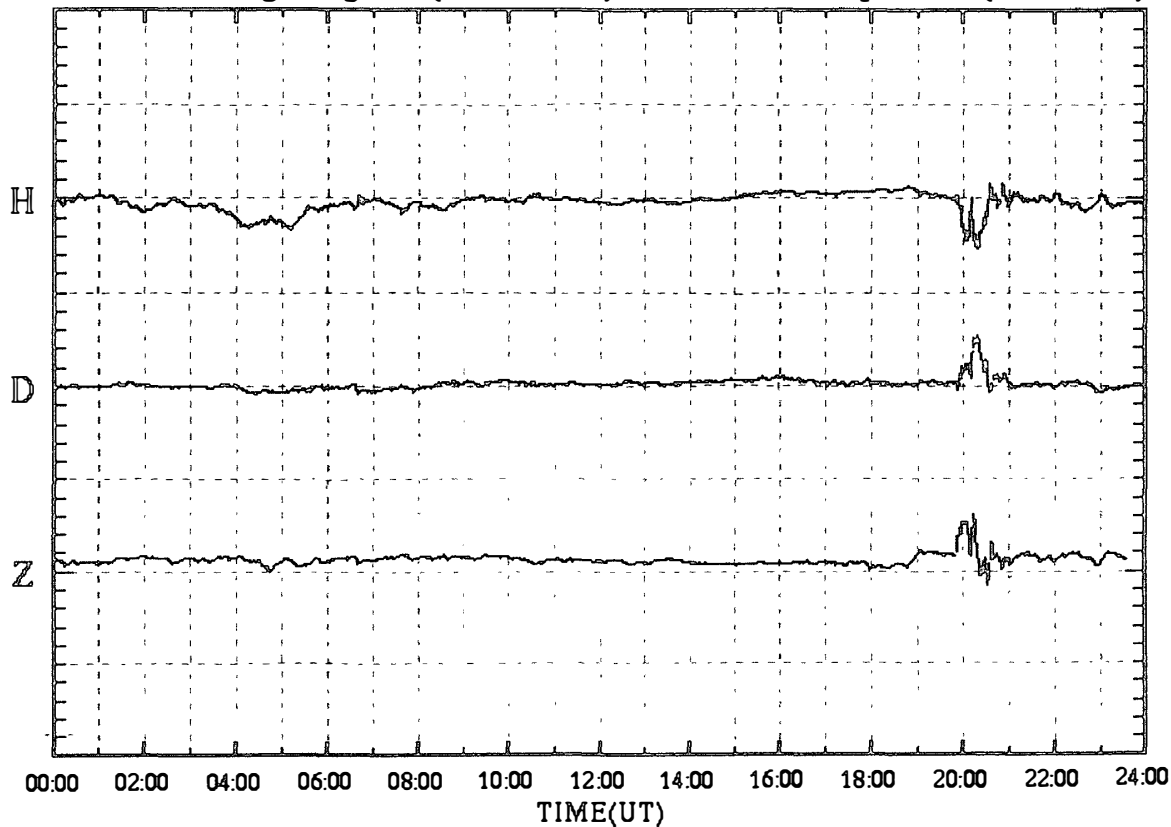

SYOWA magnetogram (100 nT/div)

12 Apr.2000 (DAY:103)

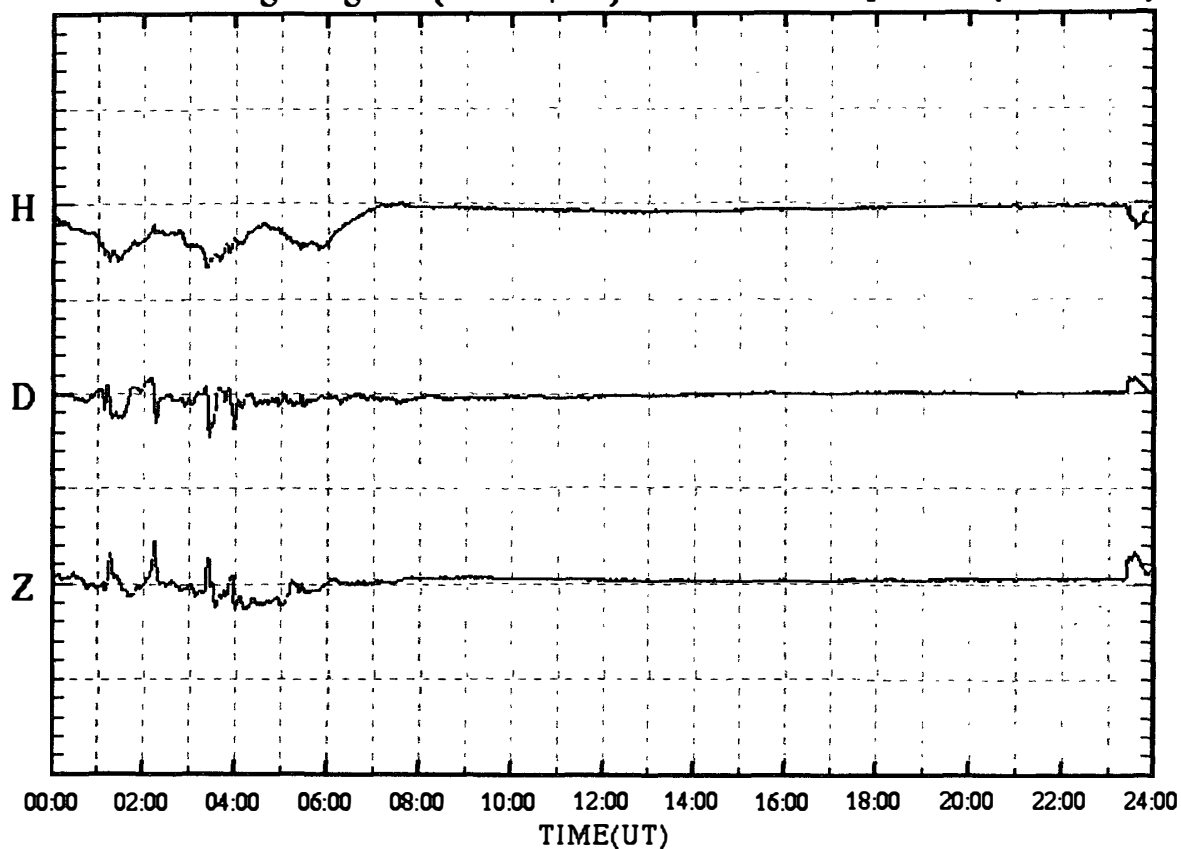

SYOWA magnetogram (100 nT/div)

13 Apr.2000 (DAY:104)

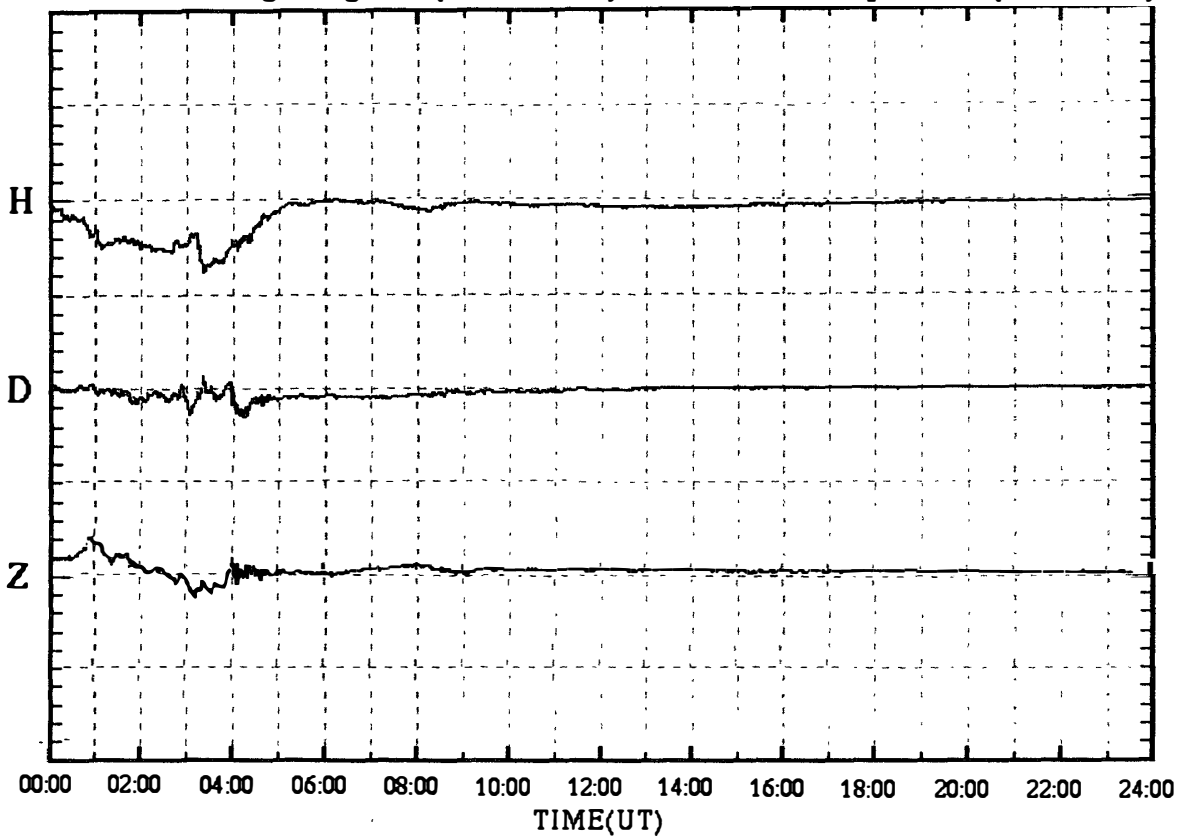

SYOWA magnetogram (100 nT/div)

14 Apr.2000 (DAY:105)

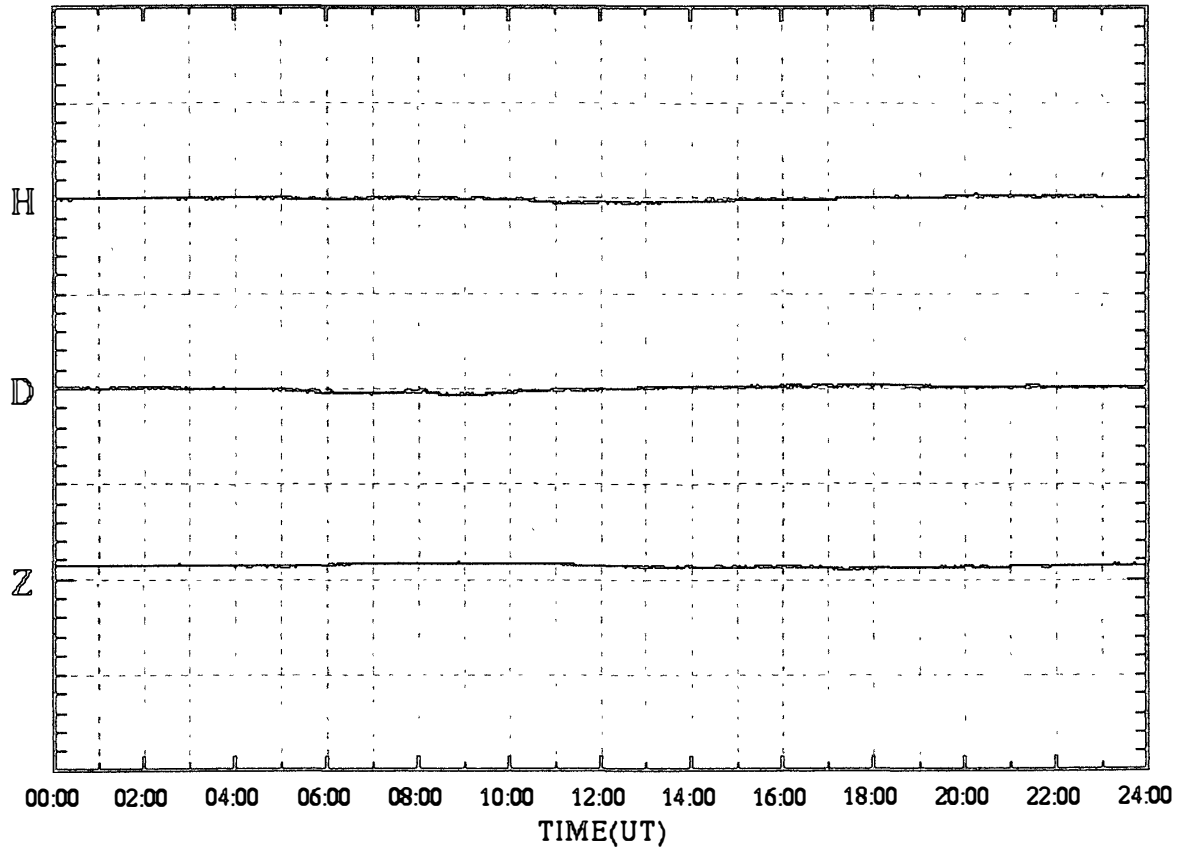

SYOWA magnetogram (100 nT/div)

15 Apr.2000 (DAY:106)

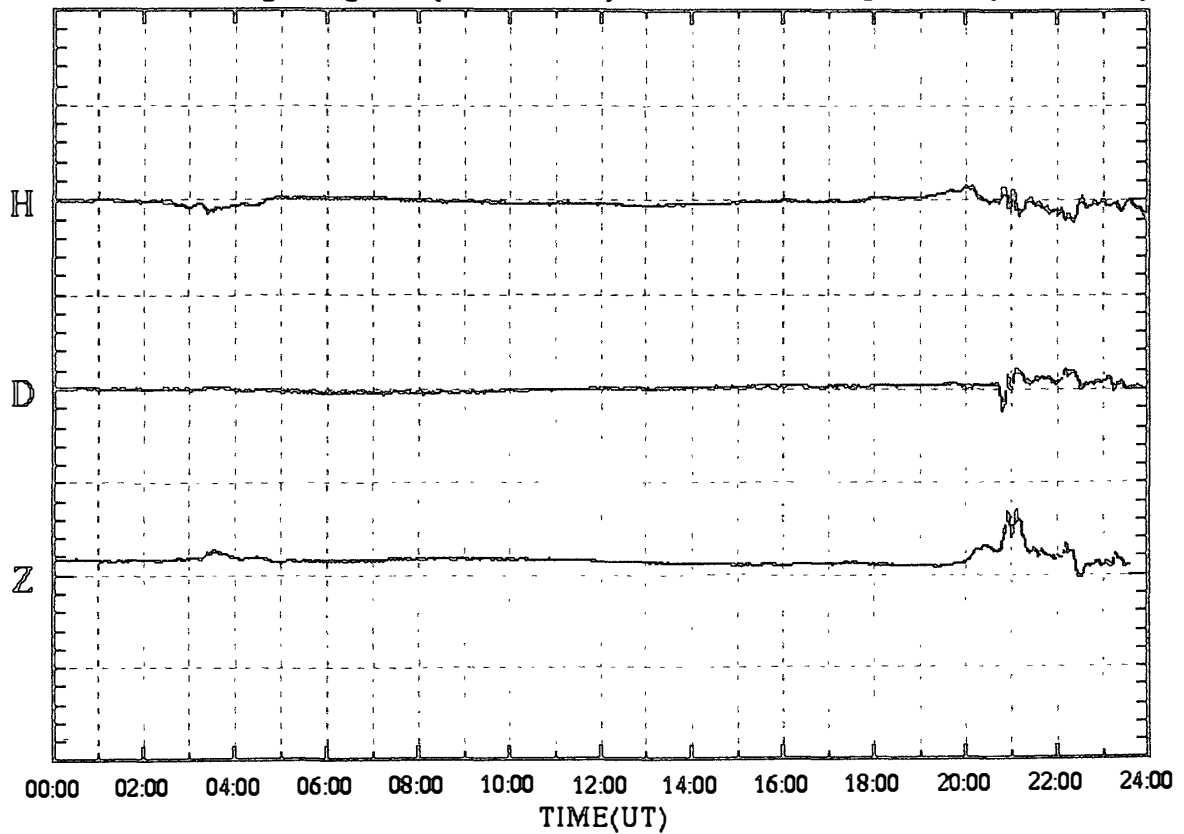

SYOWA magnetogram (100 nT/div)

16 Apr.2000 (DAY:107)

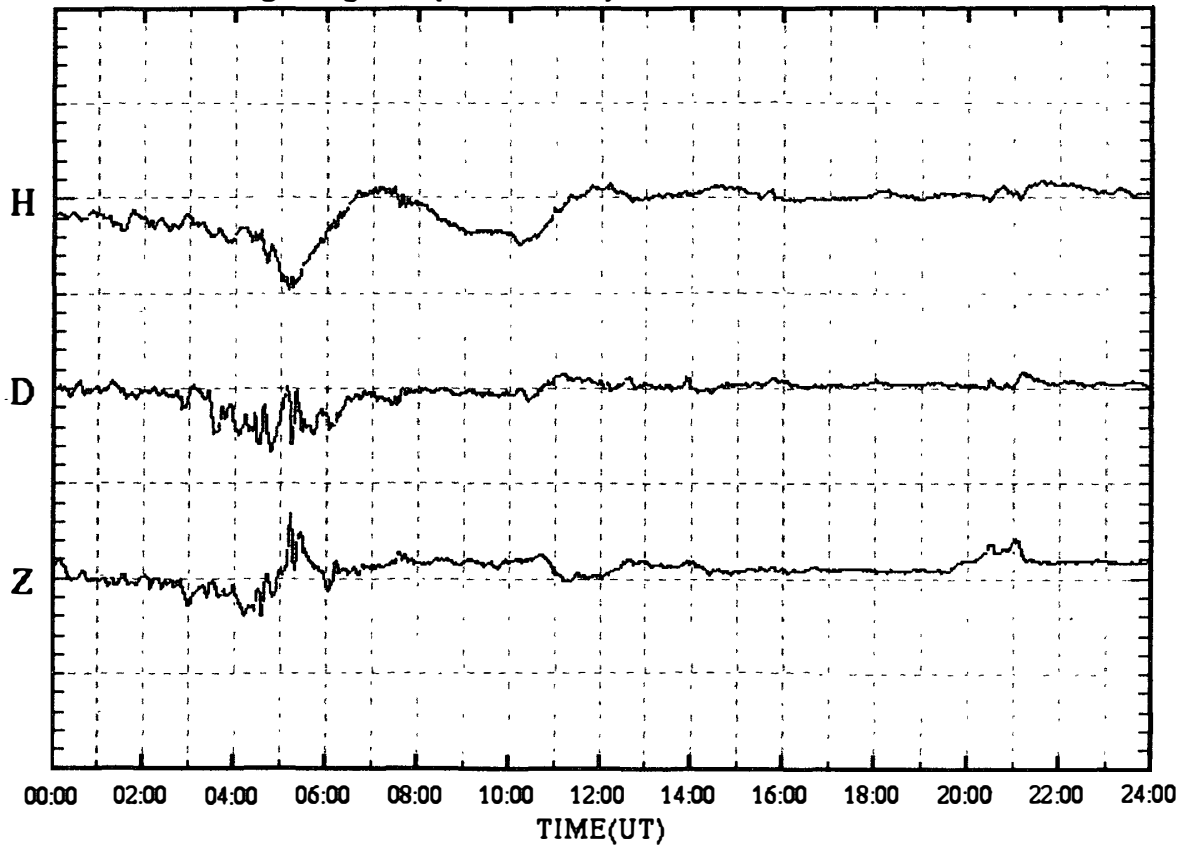

SYOWA magnetogram (100 nT/div)

17 Apr.2000 (DAY:108)

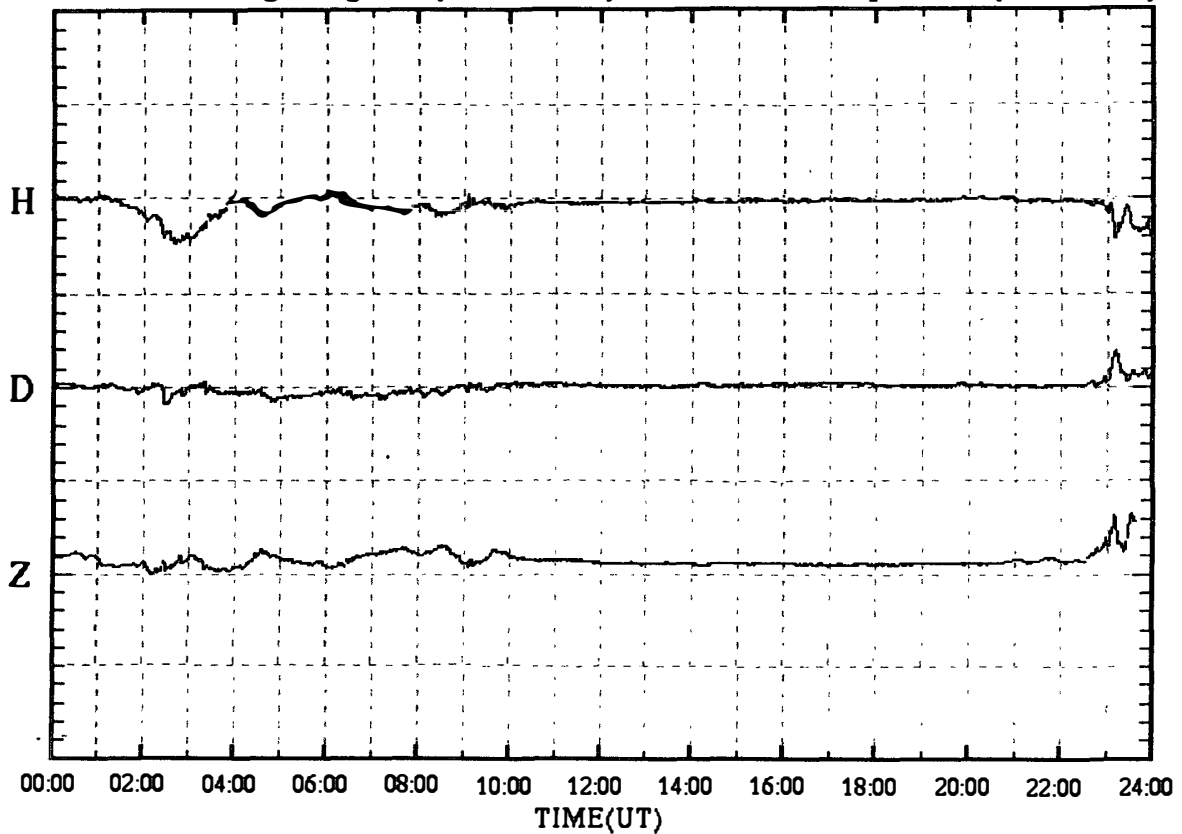

SYOWA magnetogram (100 nT/div)

18 Apr.2000 (DAY:109)

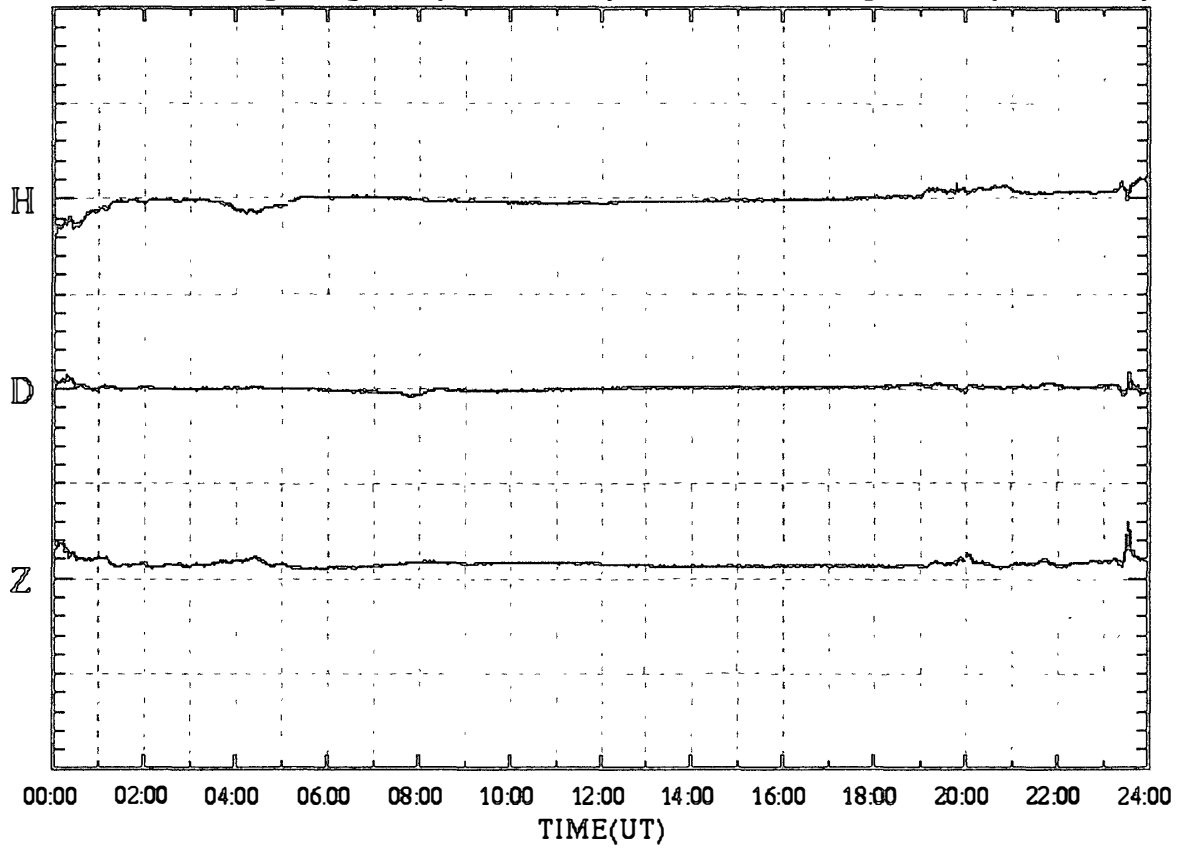

SYOWA magnetogram (100 nT/div)

19 Apr.2000 (DAY:110)

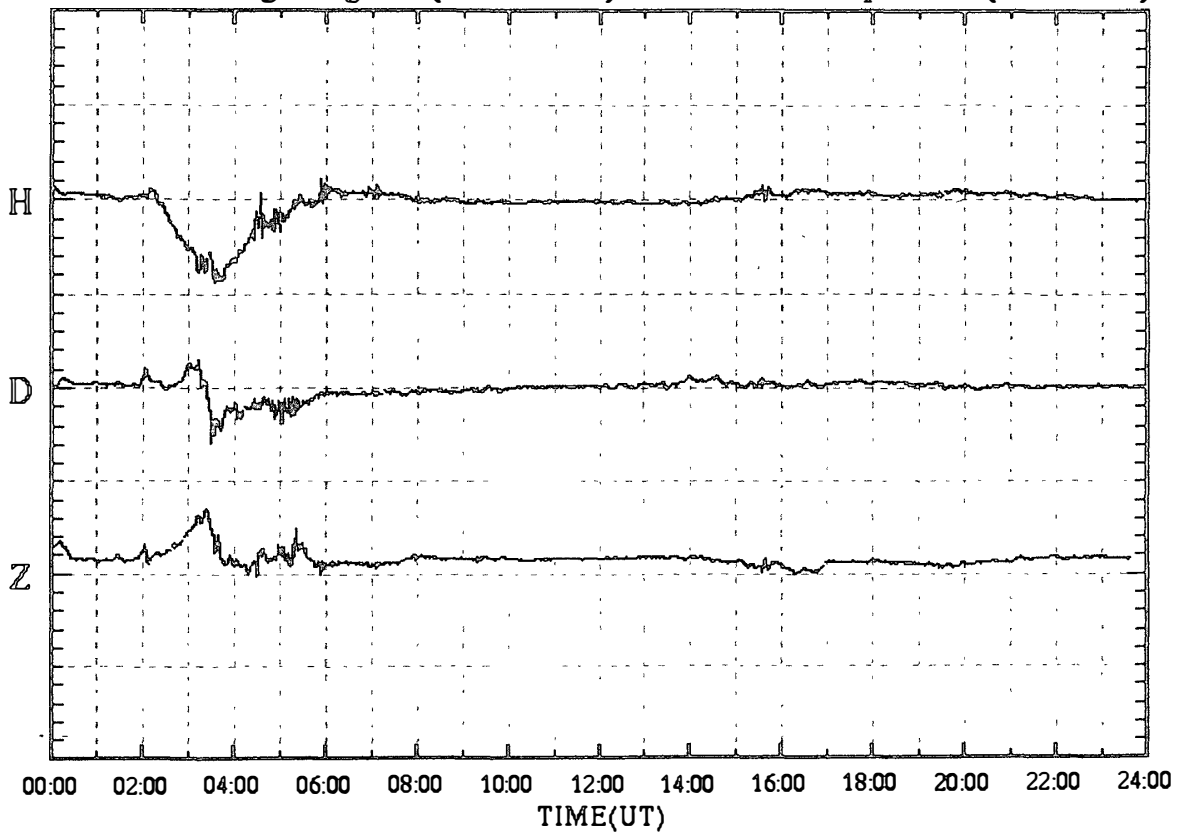

SYOWA magnetogram (100 nT/div)

20 Apr.2000 (DAY:111)

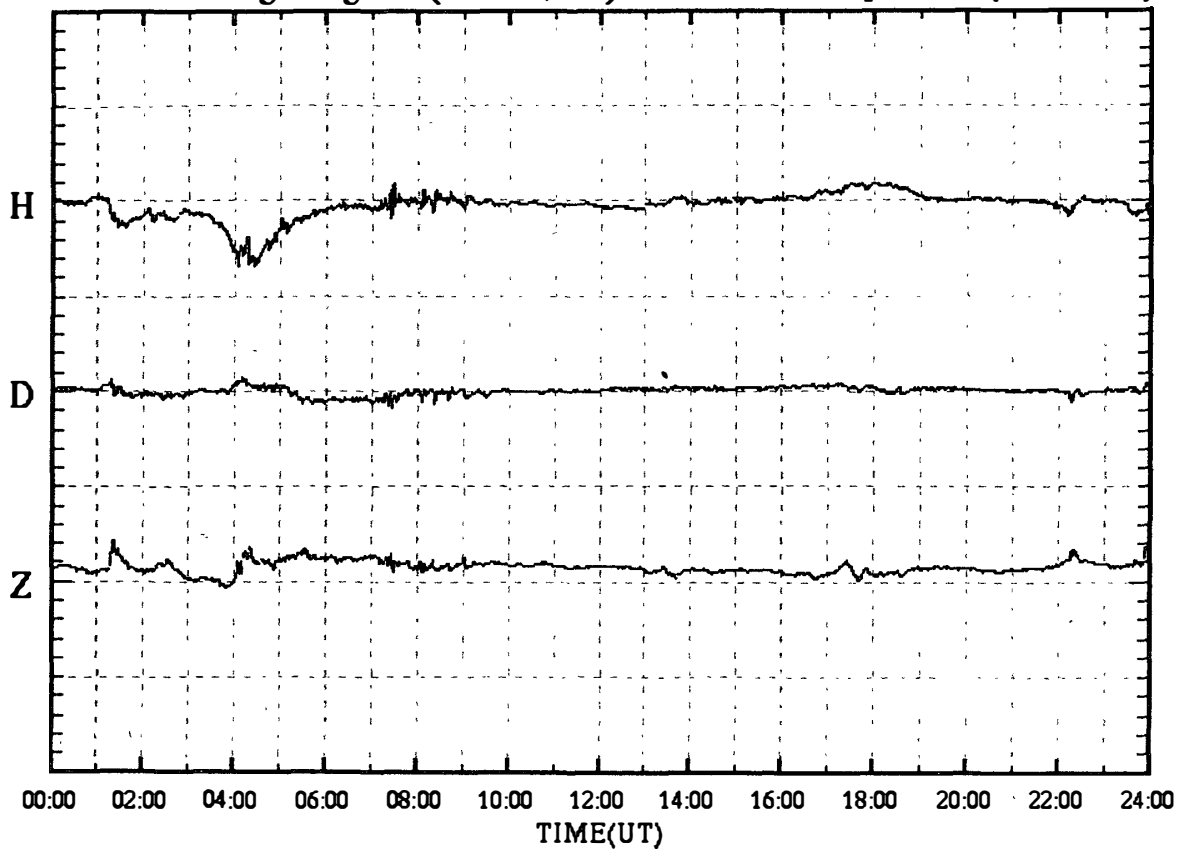

SYOWA magnetogram (100 nT/div)

21 Apr.2000 (DAY:112)

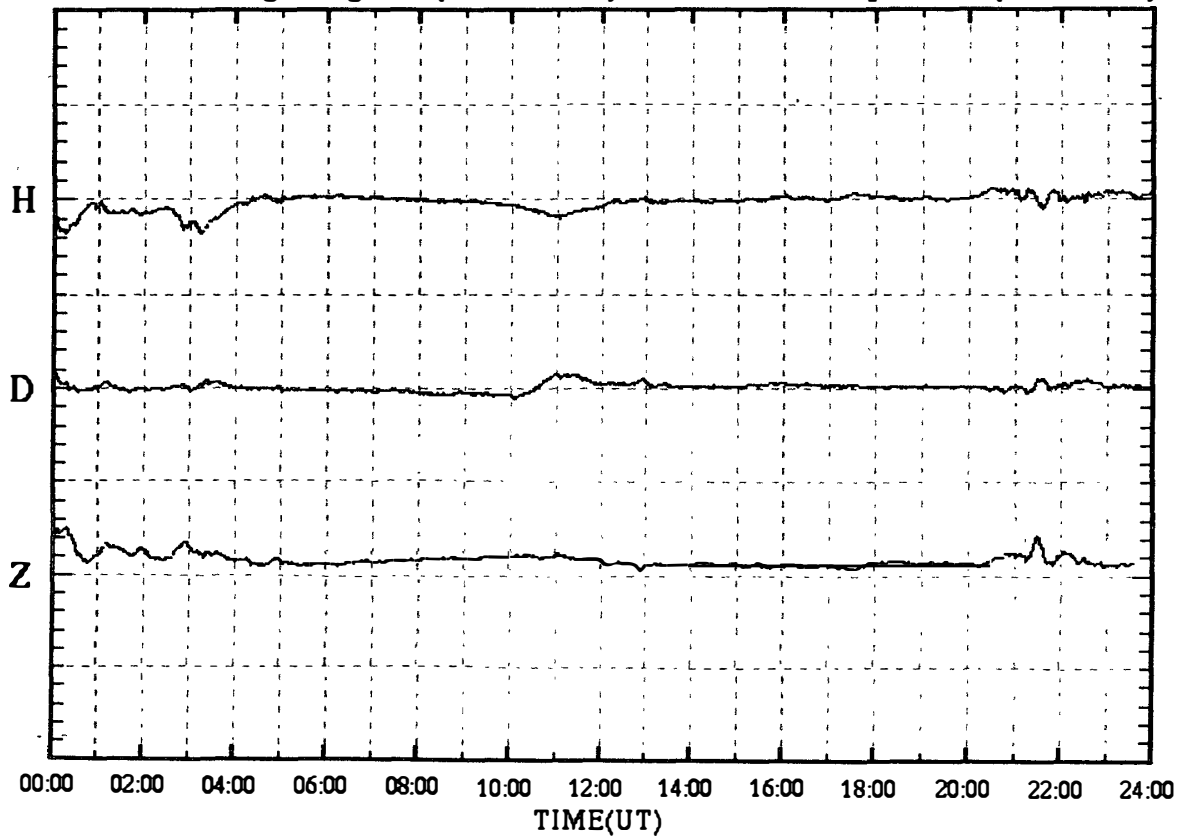

SYOWA magnetogram (100 nT/div)

22 Apr.2000 (DAY:113)

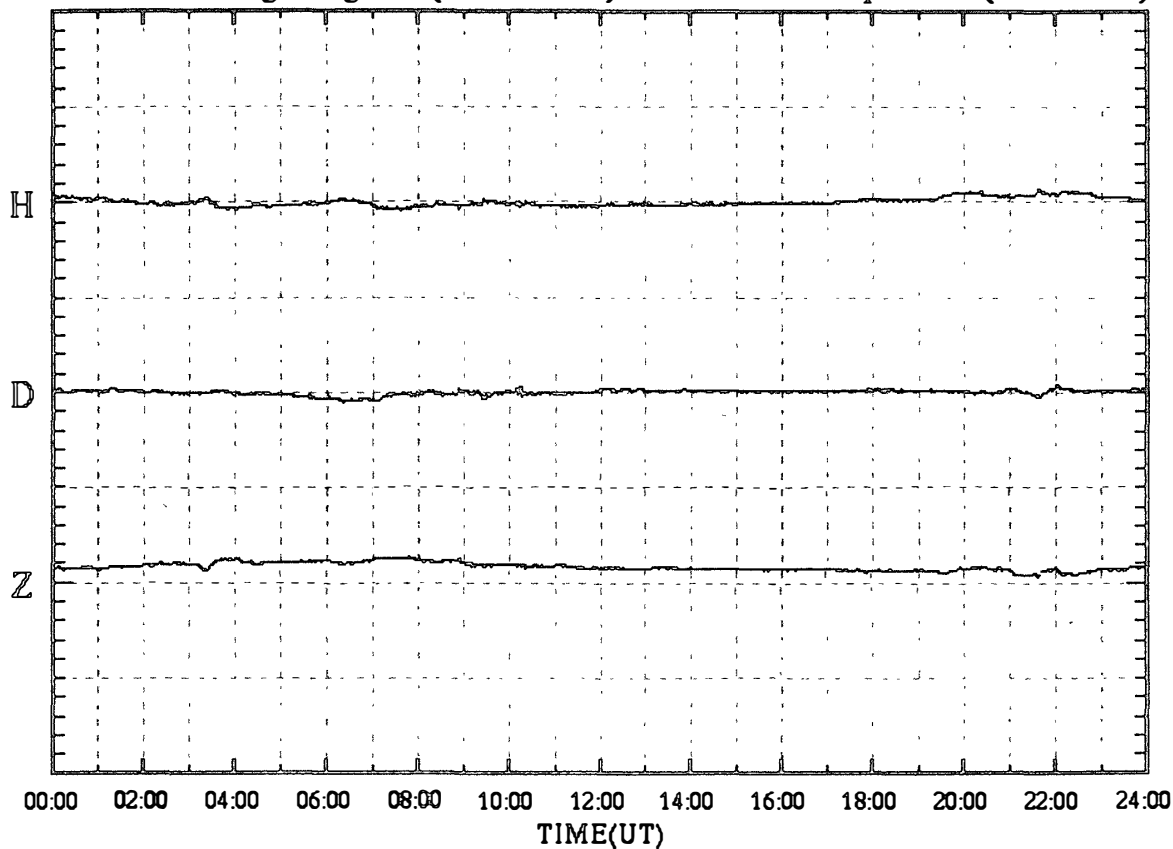

SYOWA magnetogram (100 nT/div)

23 Apr.2000 (DAY:114)

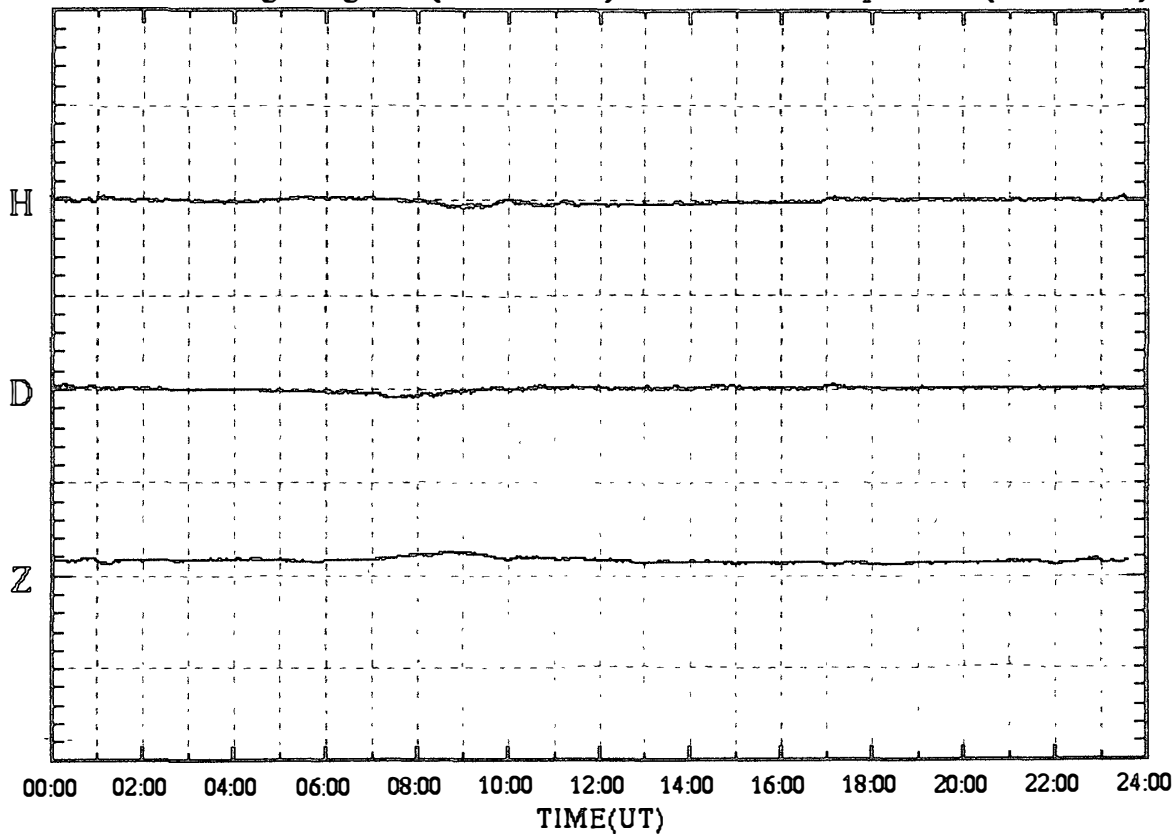

SYOWA magnetogram (100 nT/div)

24 Apr.2000 (DAY:115)

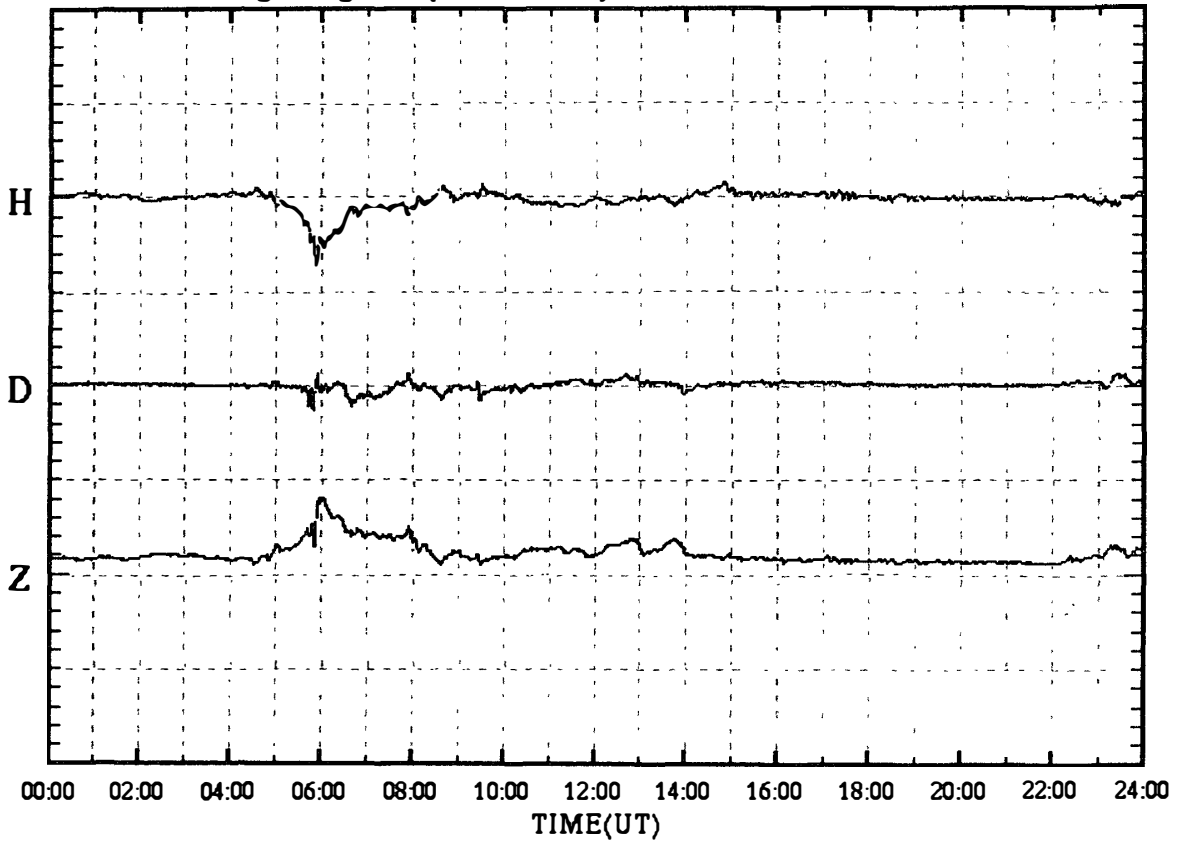

SYOWA magnetogram (100 nT/div)

25 Apr.2000 (DAY:116)

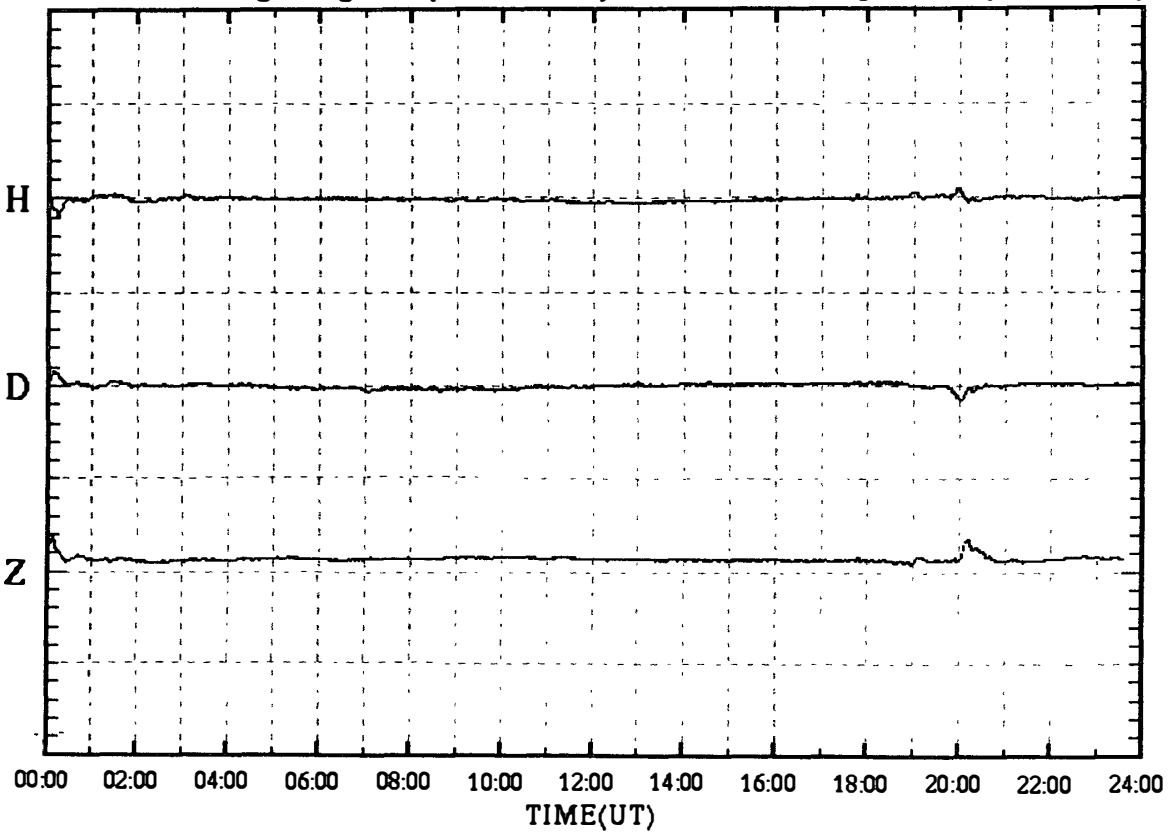

SYOWA magnetogram (100 nT/div)

26 Apr.2000 (DAY:117)

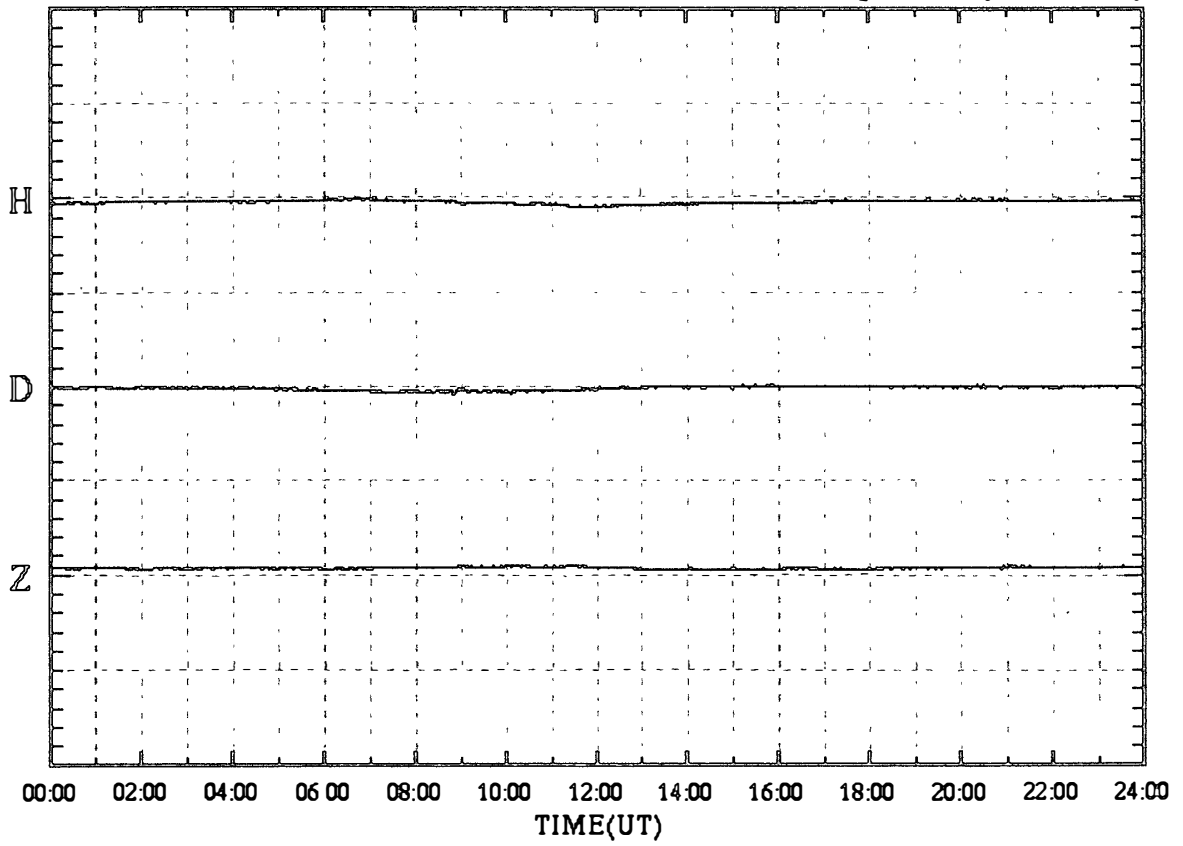

SYOWA magnetogram (100 nT/div)

27 Apr.2000 (DAY:118)

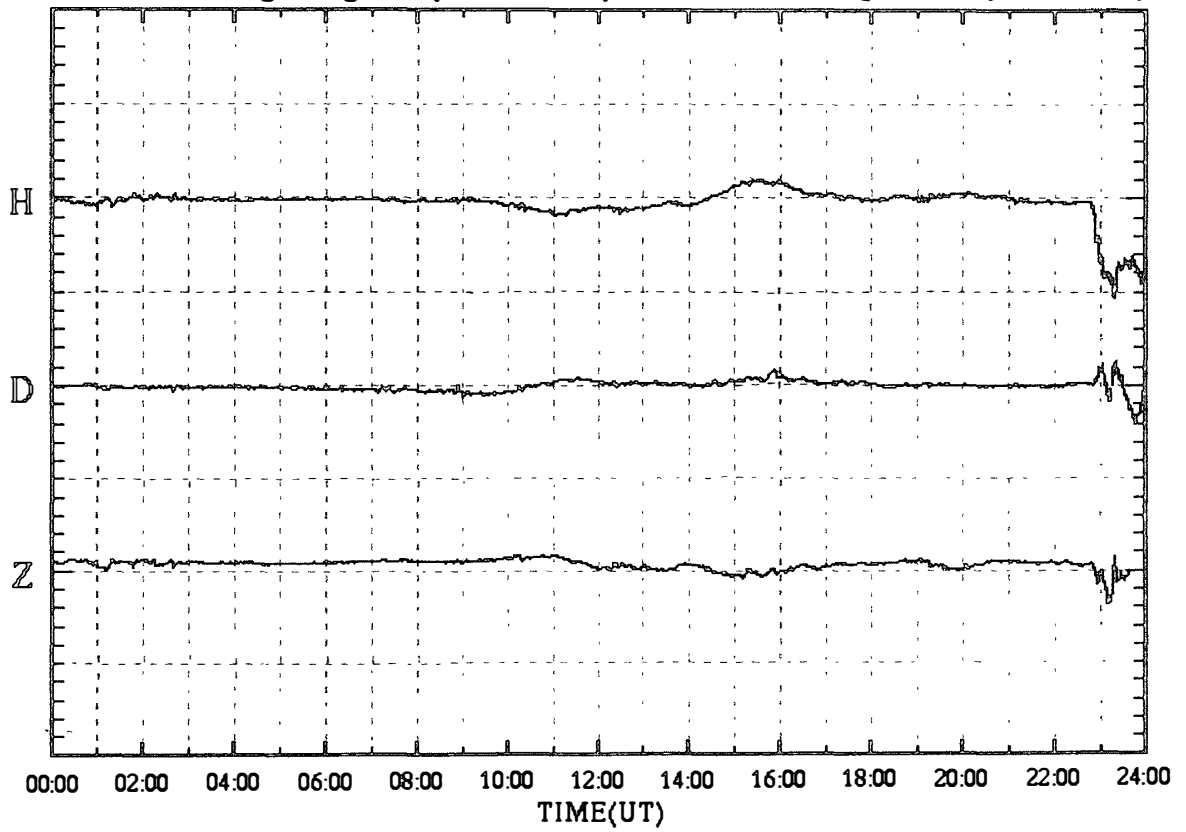

SYOWA magnetogram (100 nT/div)

28 Apr.2000 (DAY:119)

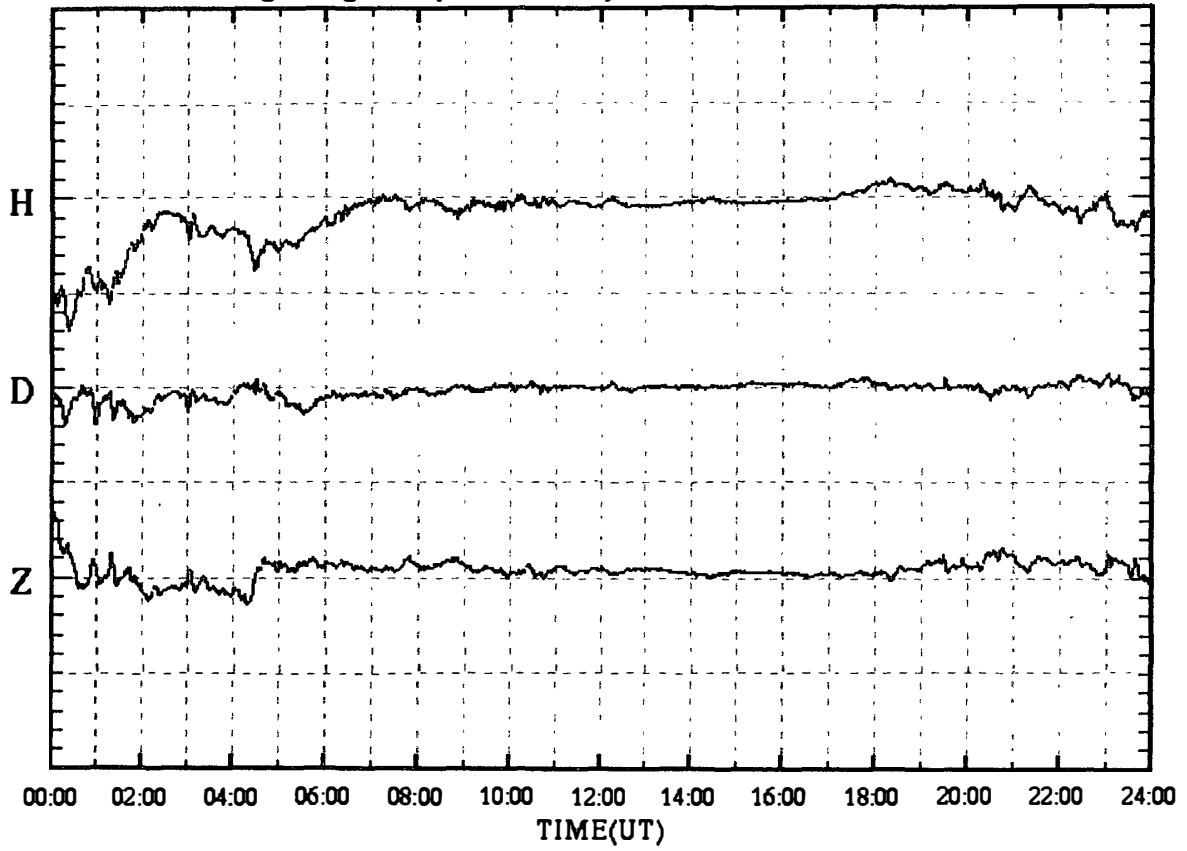

SYOWA magnetogram (100 nT/div)

29 Apr.2000 (DAY:120)

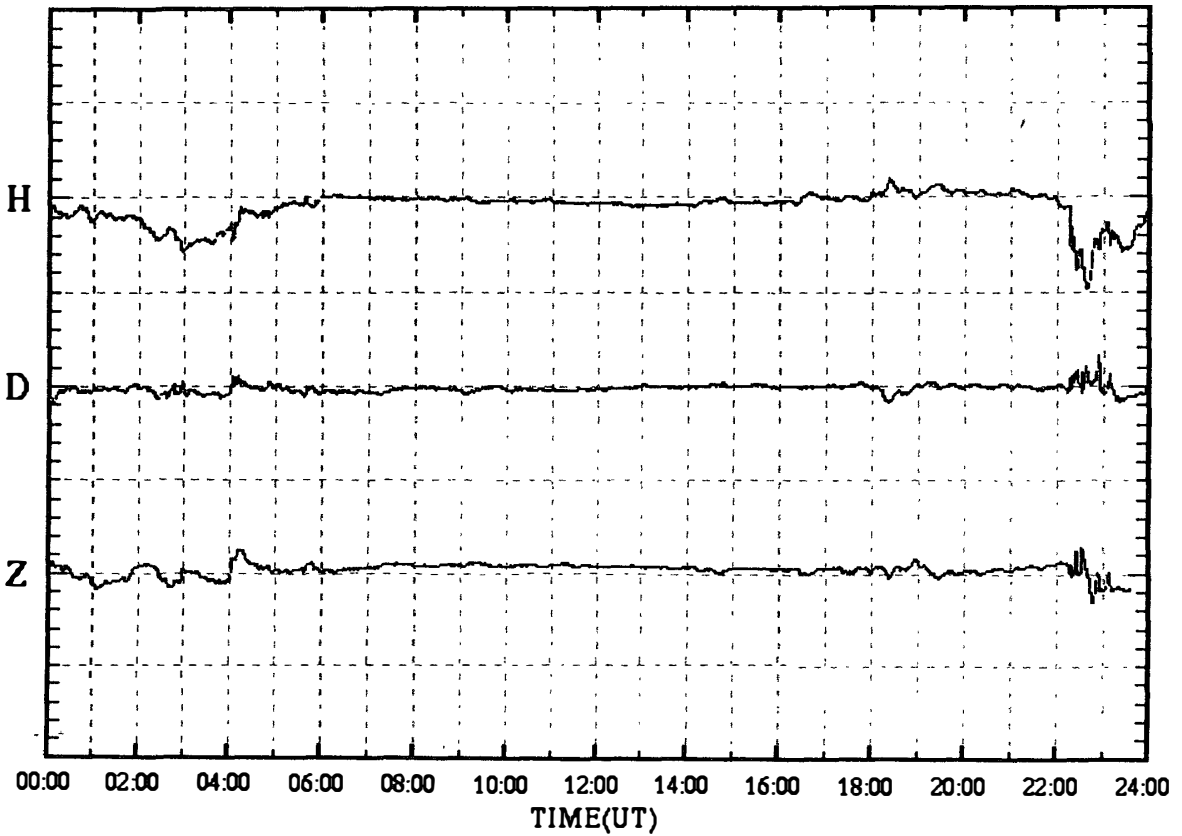

SYOWA magnetogram (100 nT/div)

30 Apr.2000 (DAY:121)

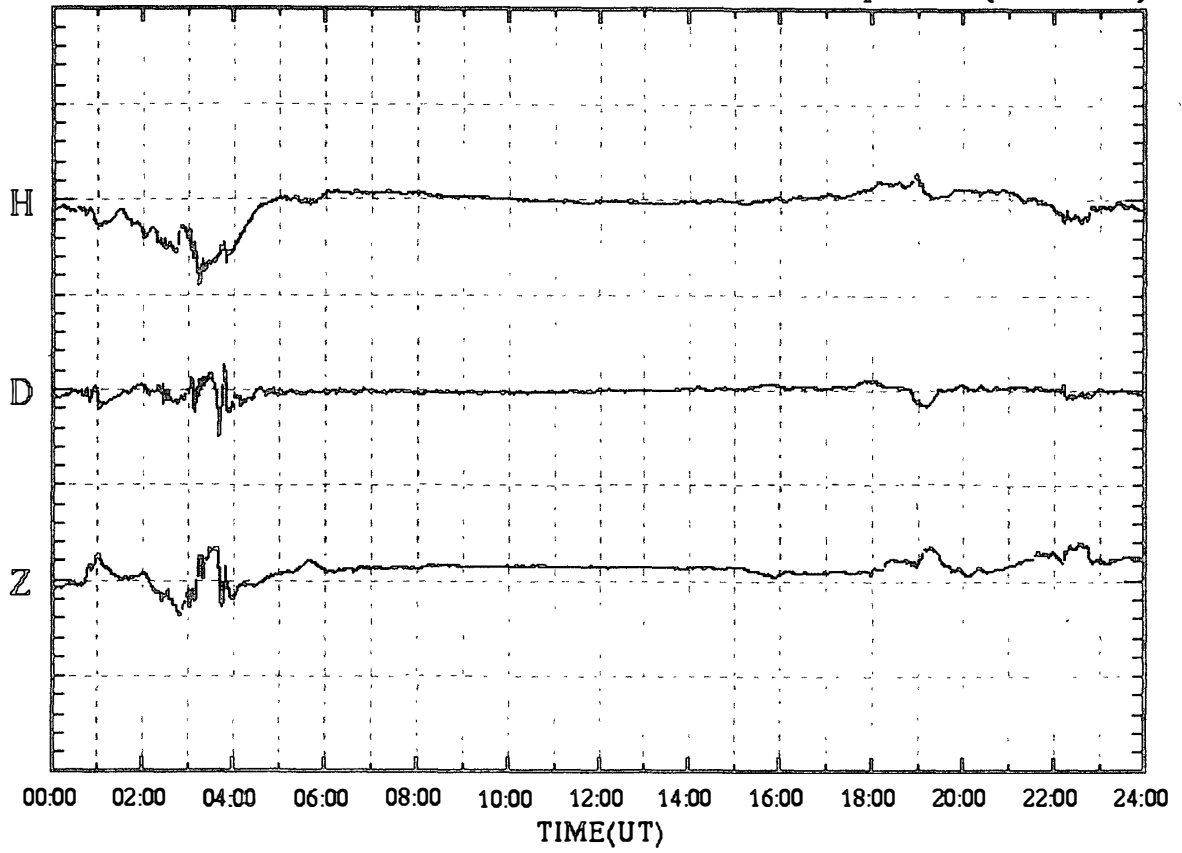

SYOWA magnetogram (100 nT/div)

01 May 2000 (DAY:122)

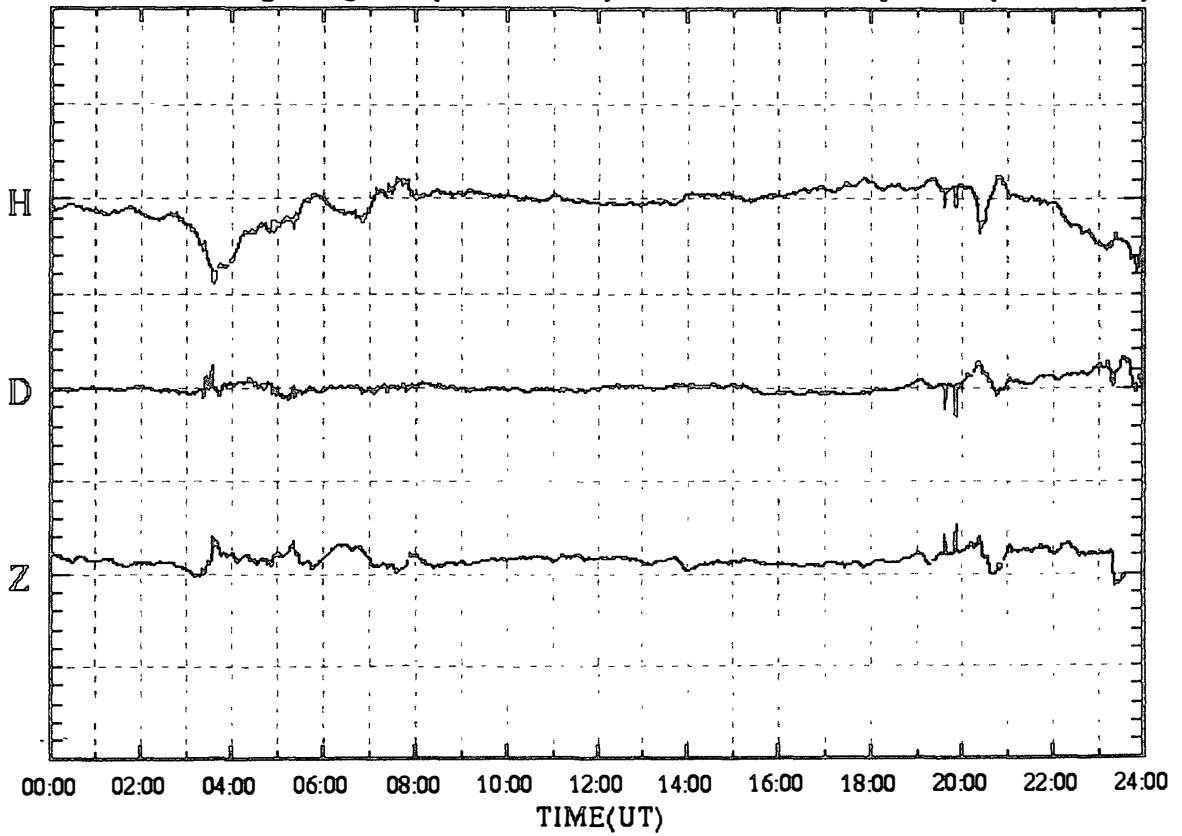

SYOWA magnetogram (100 nT/div)

02 May 2000 (DAY:123)

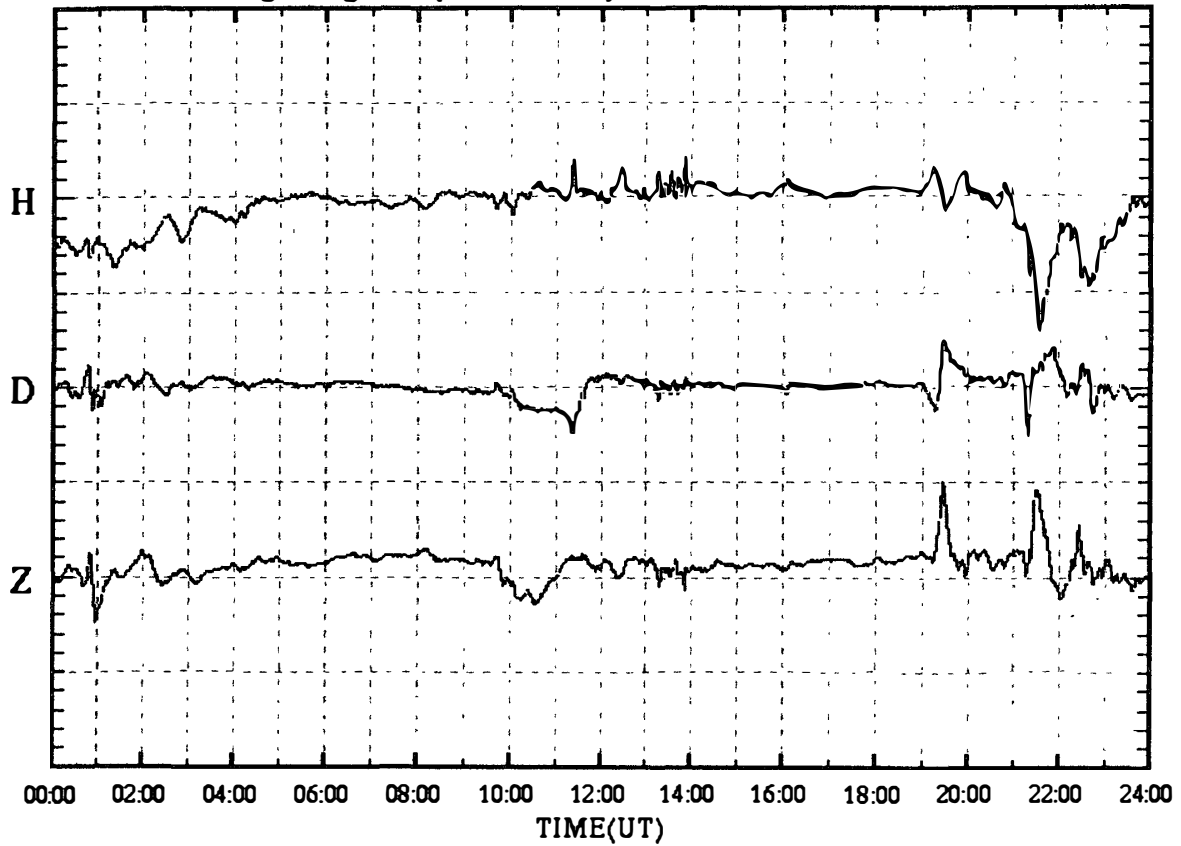

SYOWA magnetogram (100 nT/div)

03 May 2000 (DAY:124)

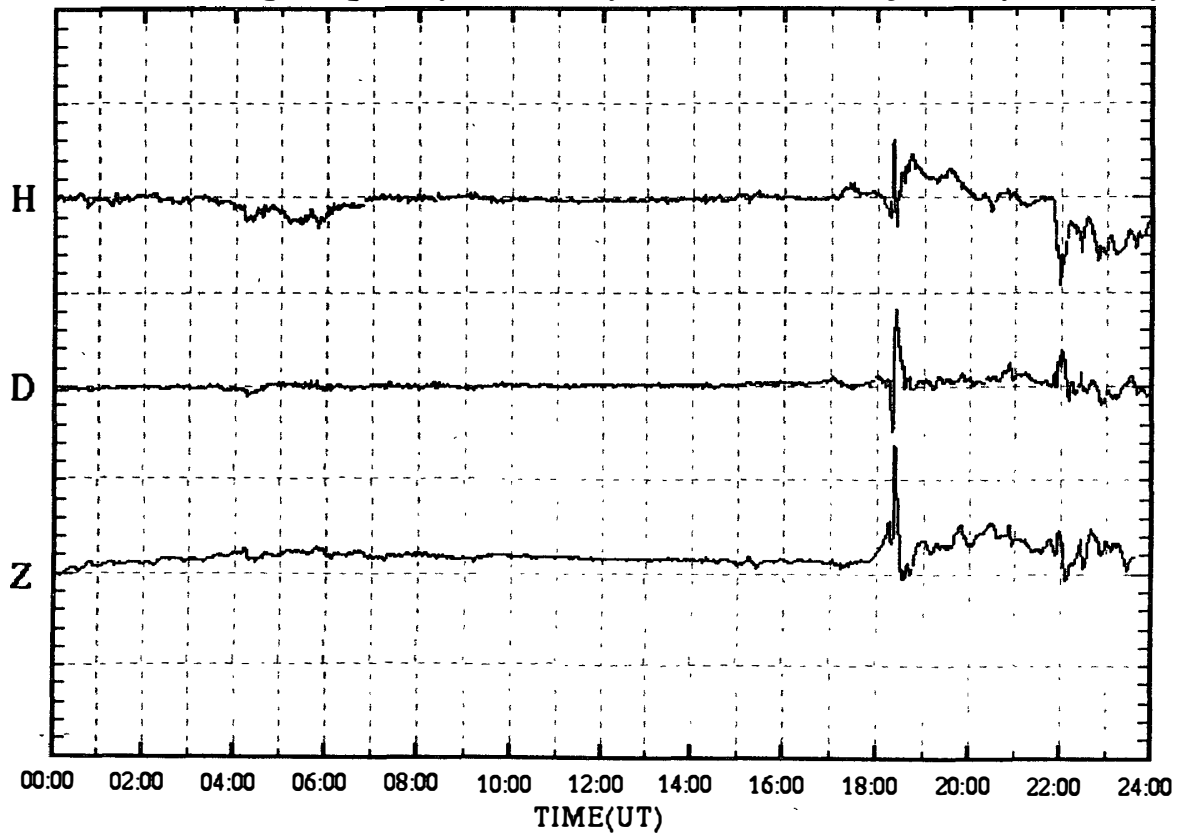

SYOWA magnetogram (100 nT/div)

04 May 2000 (DAY:125)

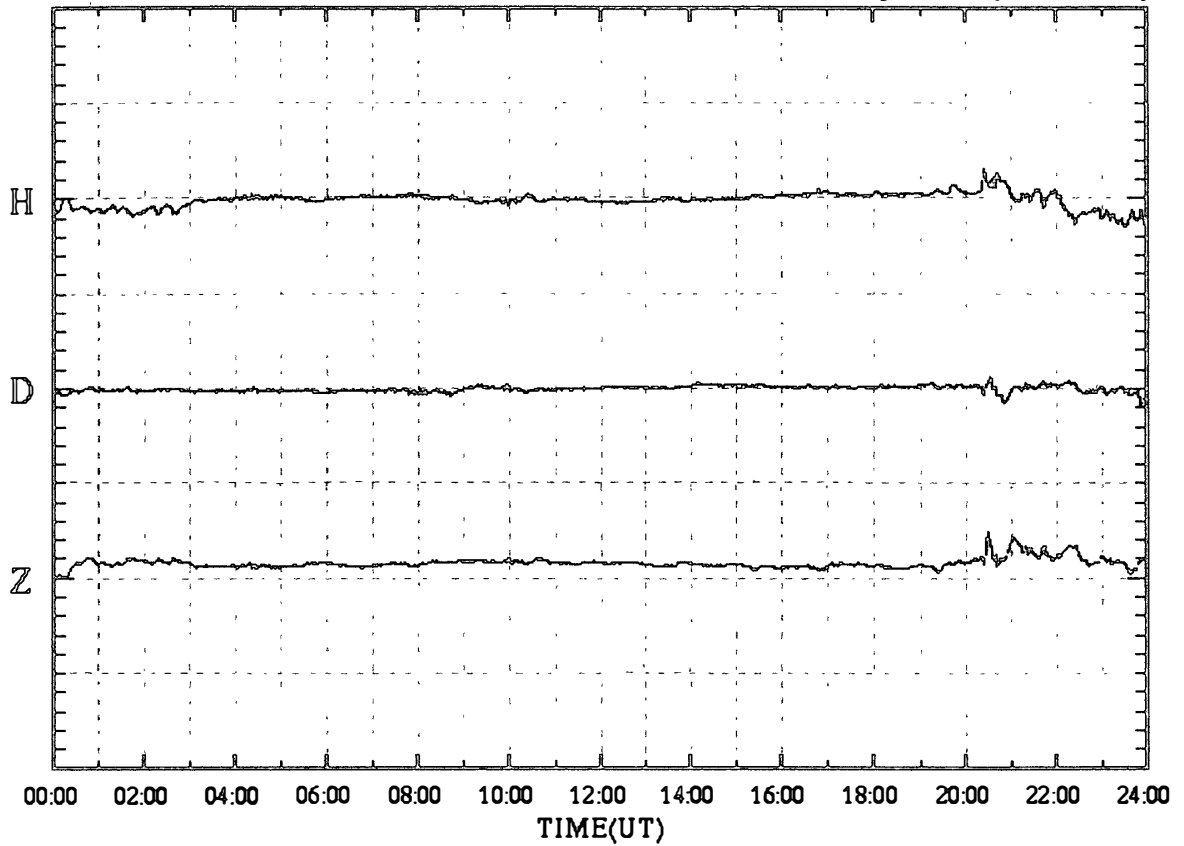

SYOWA magnetogram (100 nT/div)

05 May 2000 (DAY:126)

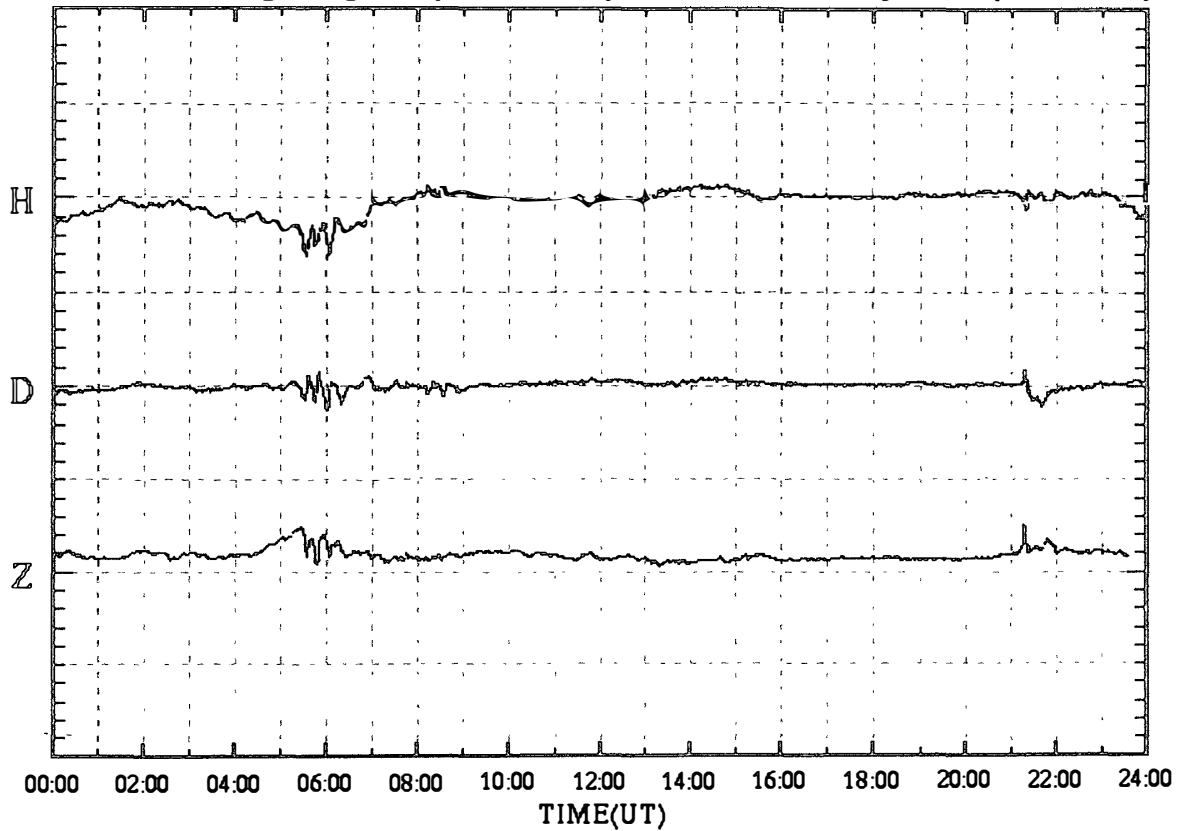

SYOWA magnetogram (100 nT/div)

06 May 2000 (DAY:127)

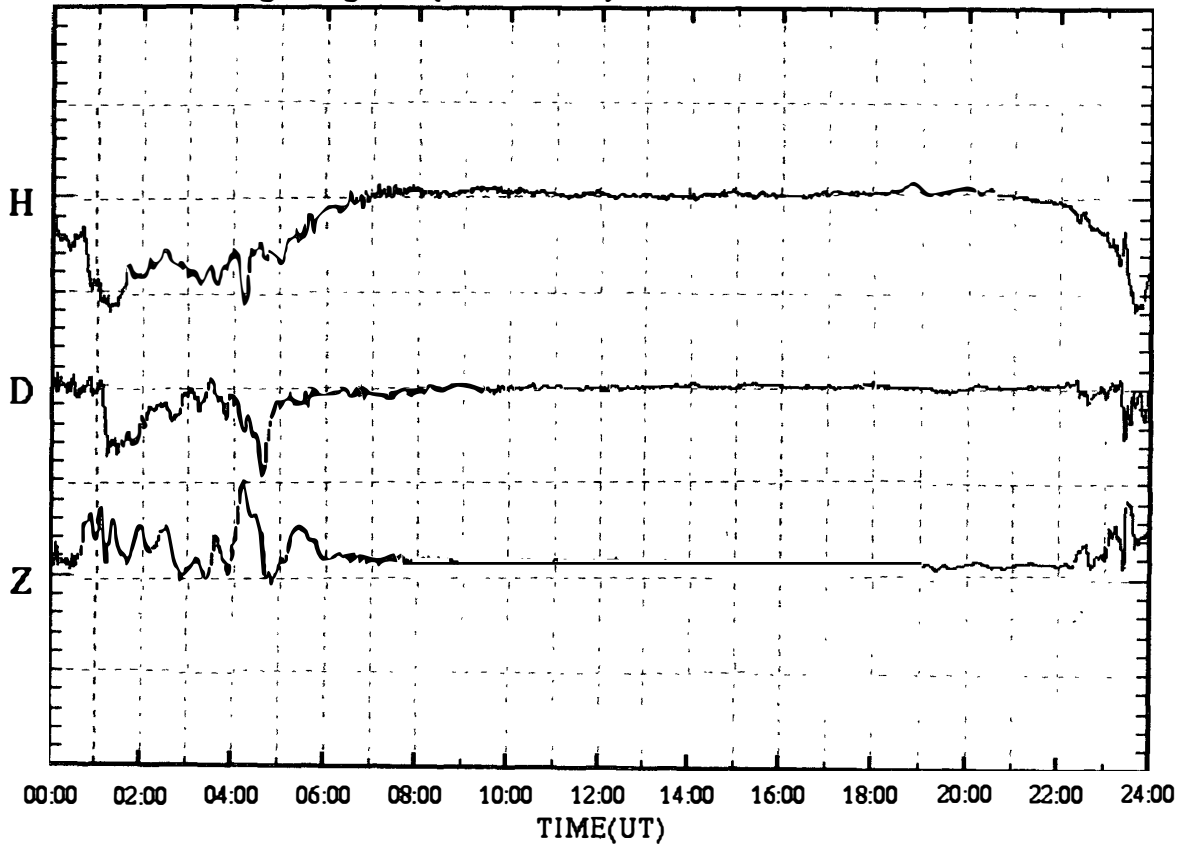

SYOWA magnetogram (100 nT/div)

07 May 2000 (DAY:128)

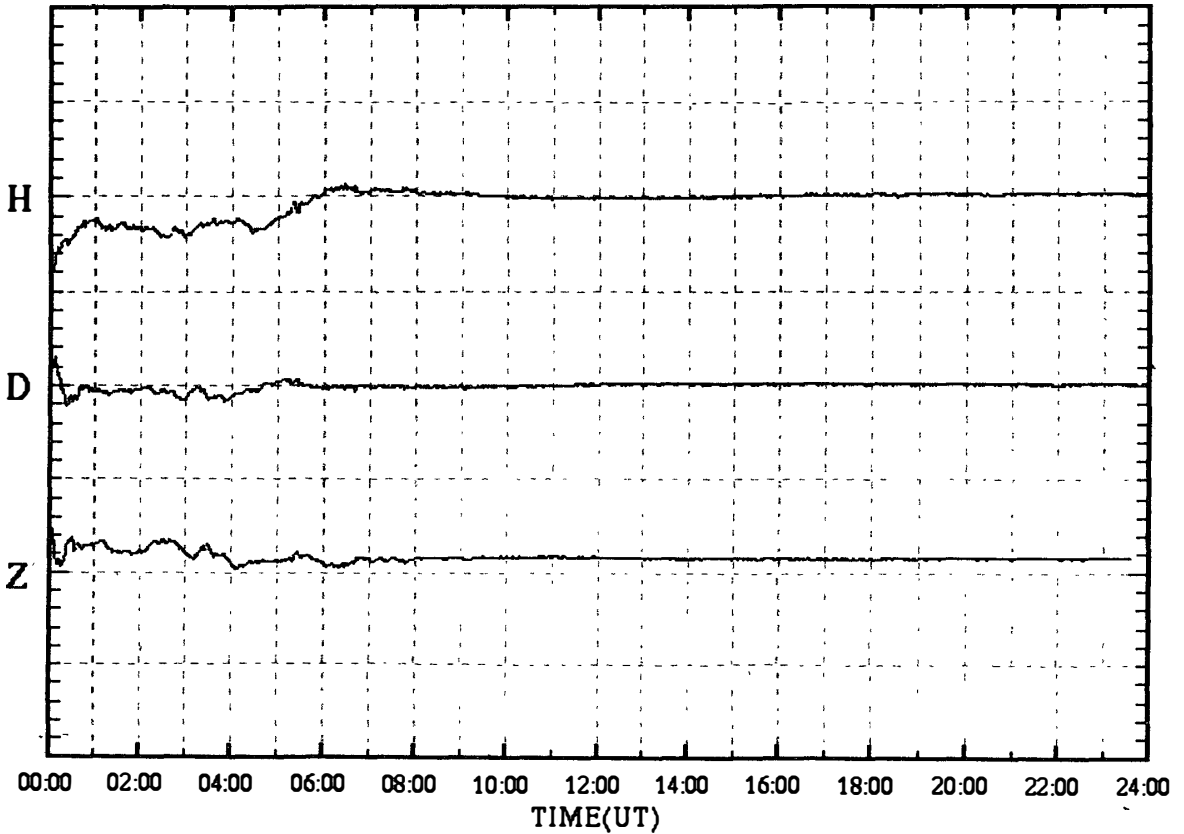

SYOWA magnetogram (100 nT/div)

08 May 2000 (DAY:129)

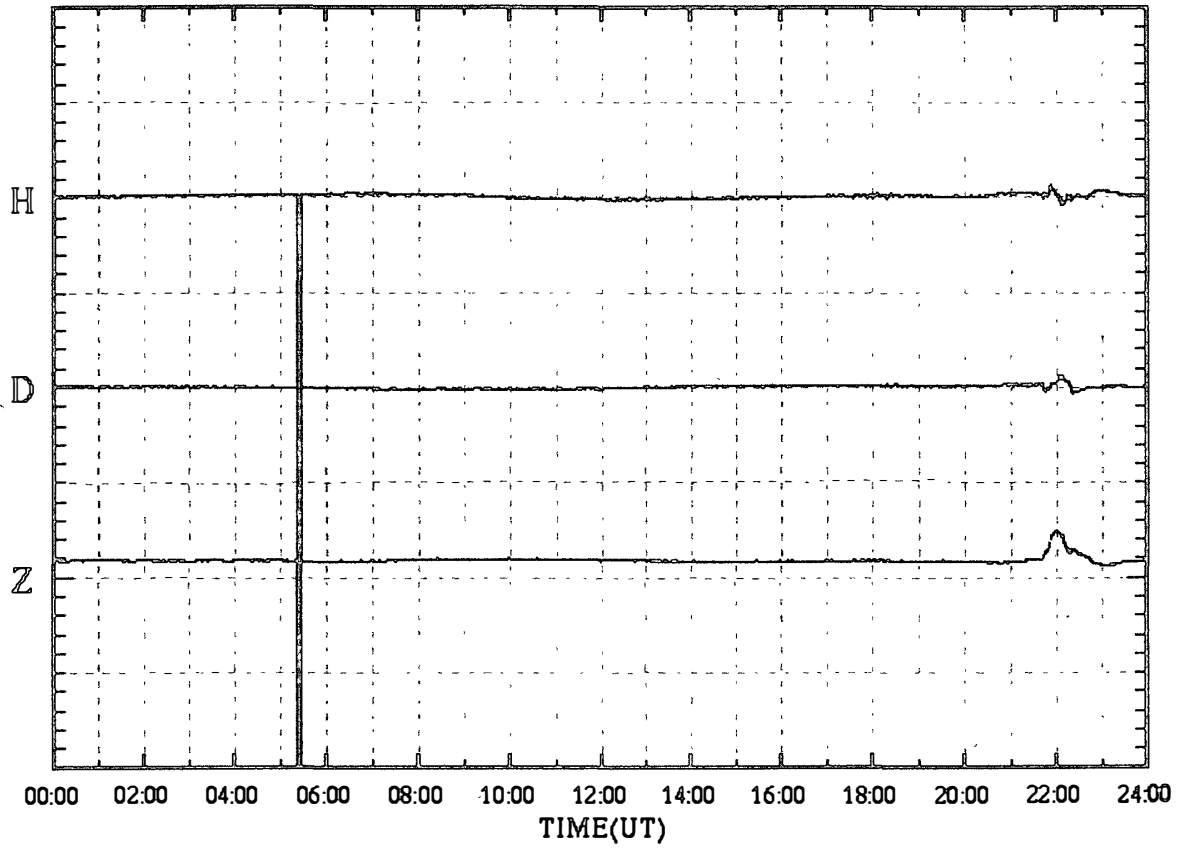

SYOWA magnetogram (100 nT/div)

09 May 2000 (DAY:130)

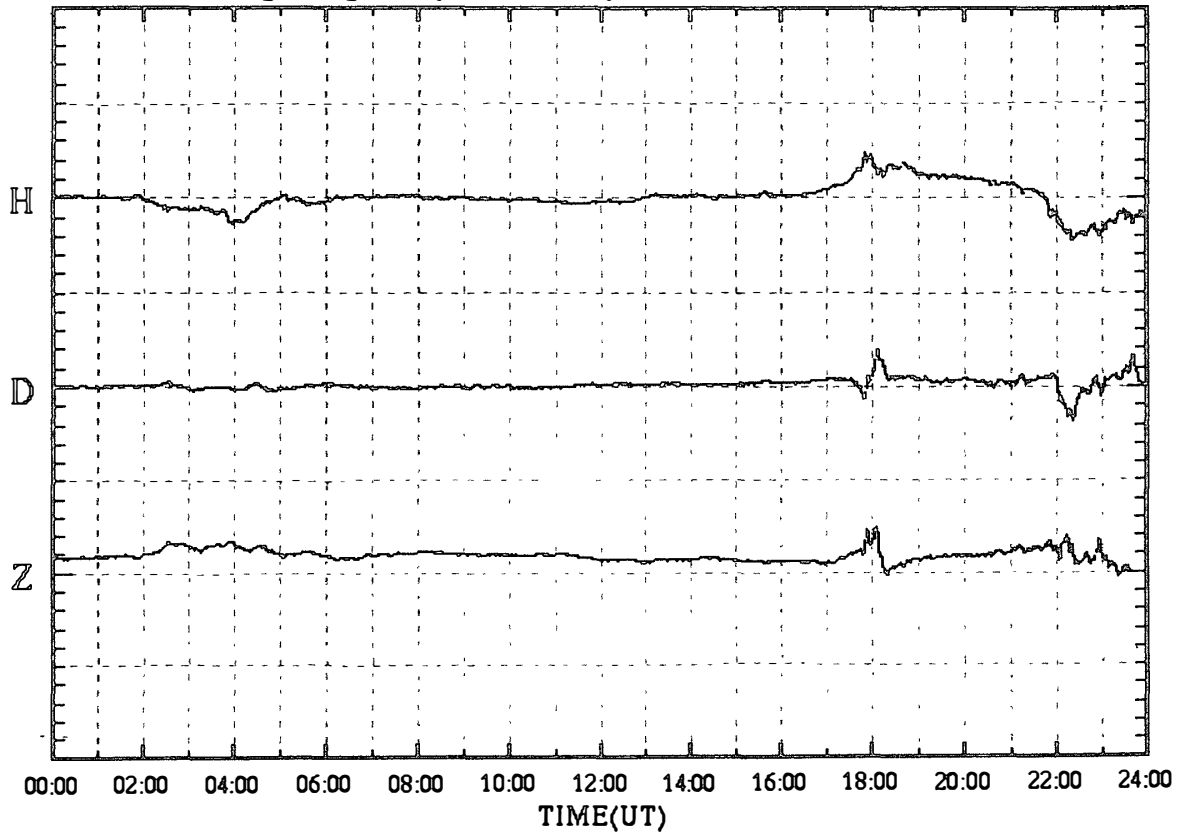

SYOWA magnetogram (100 nT/div)

10 May 2000 (DAY:131)

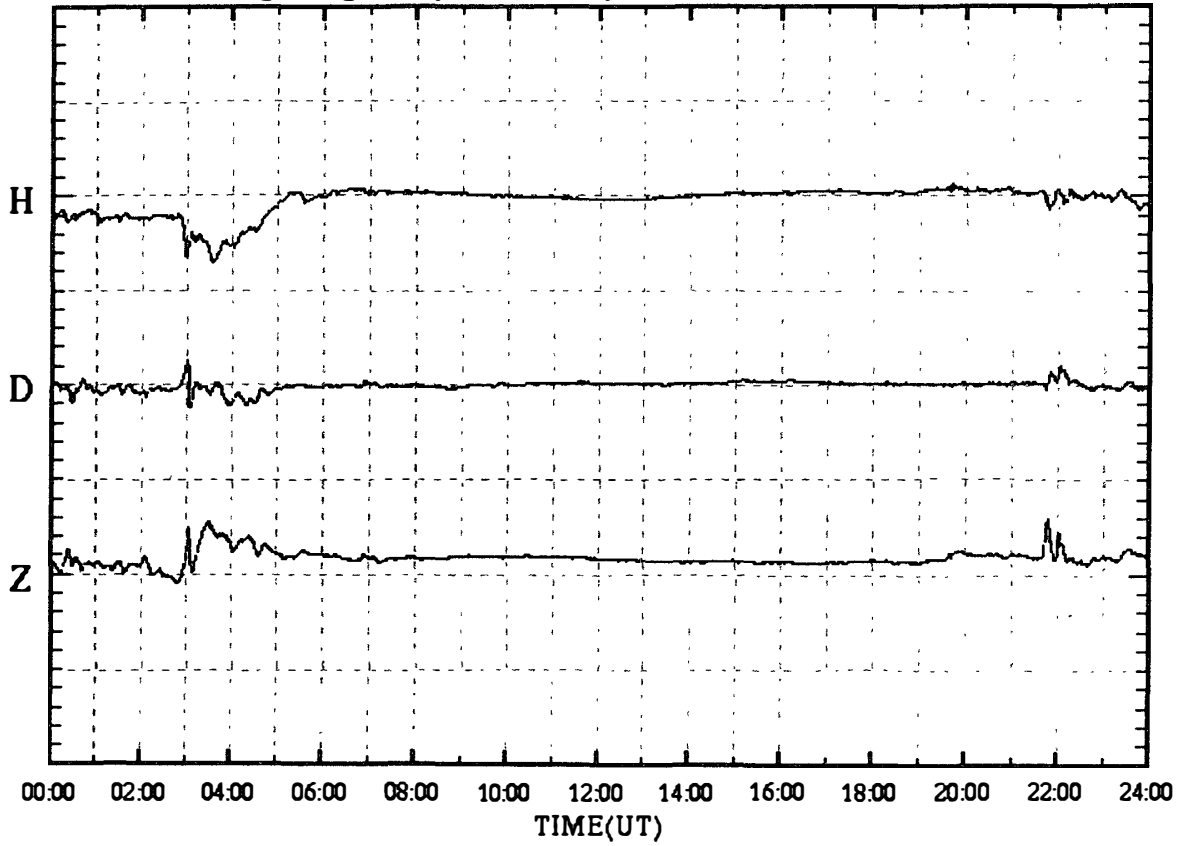

SYOWA magnetogram (100 nT/div)

11 May 2000 (DAY:132)

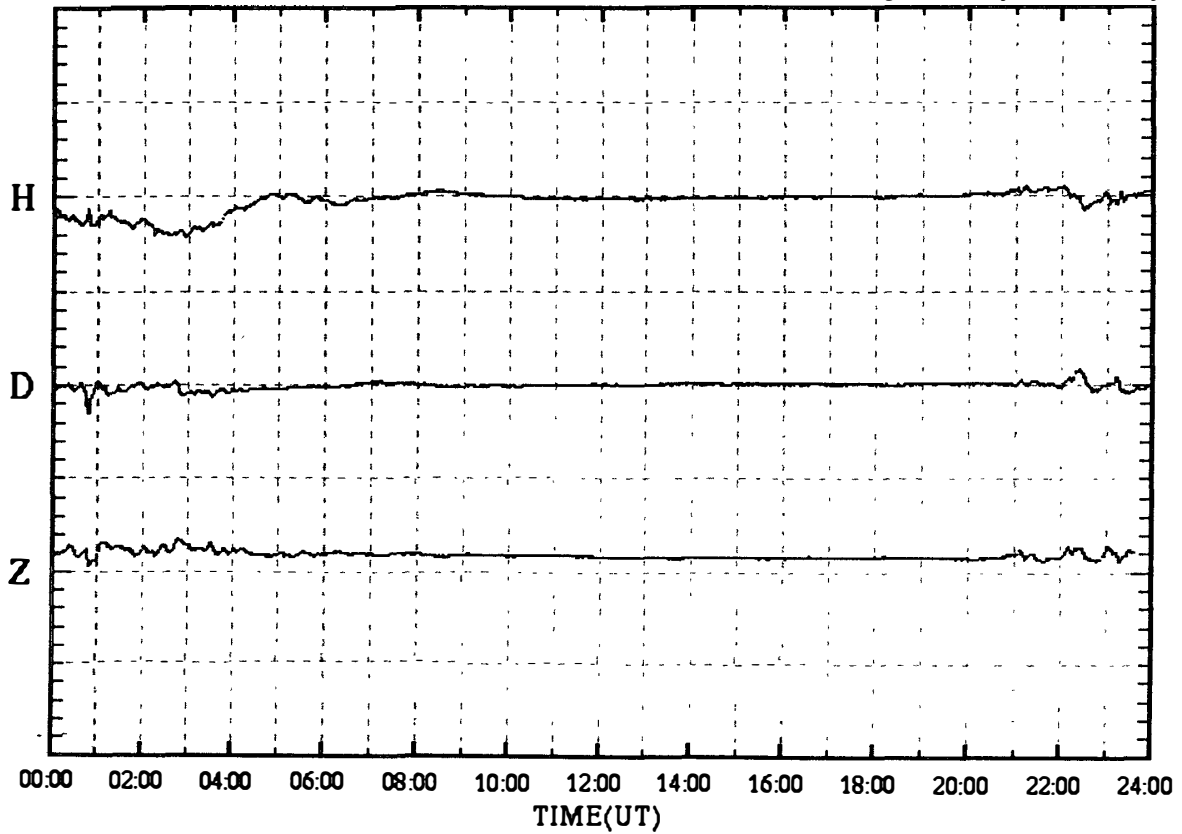

SYOWA magnetogram (100 nT/div)

12 May 2000 (DAY:133)

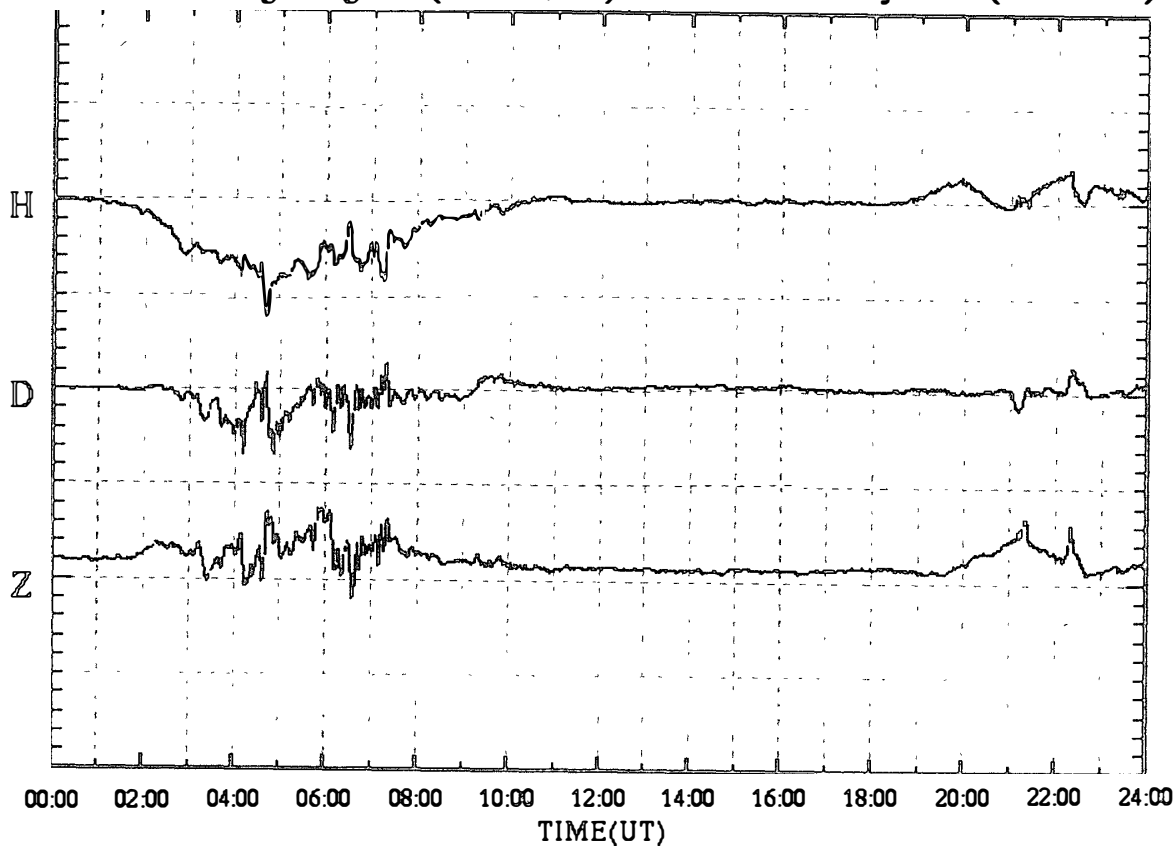

SYOWA magnetogram (100 nT/div)

13 May 2000 (DAY:134)

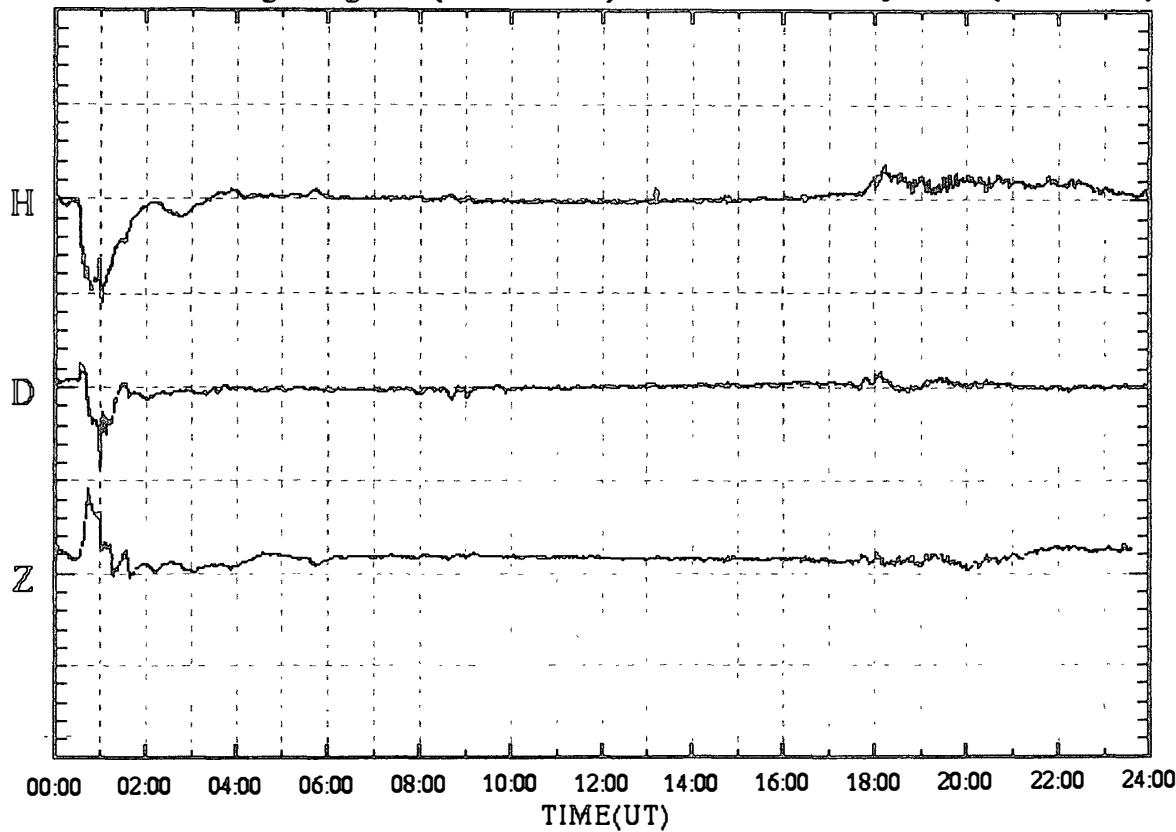

SYOWA magnetogram (100 nT/div)

14 May 2000 (DAY:135)

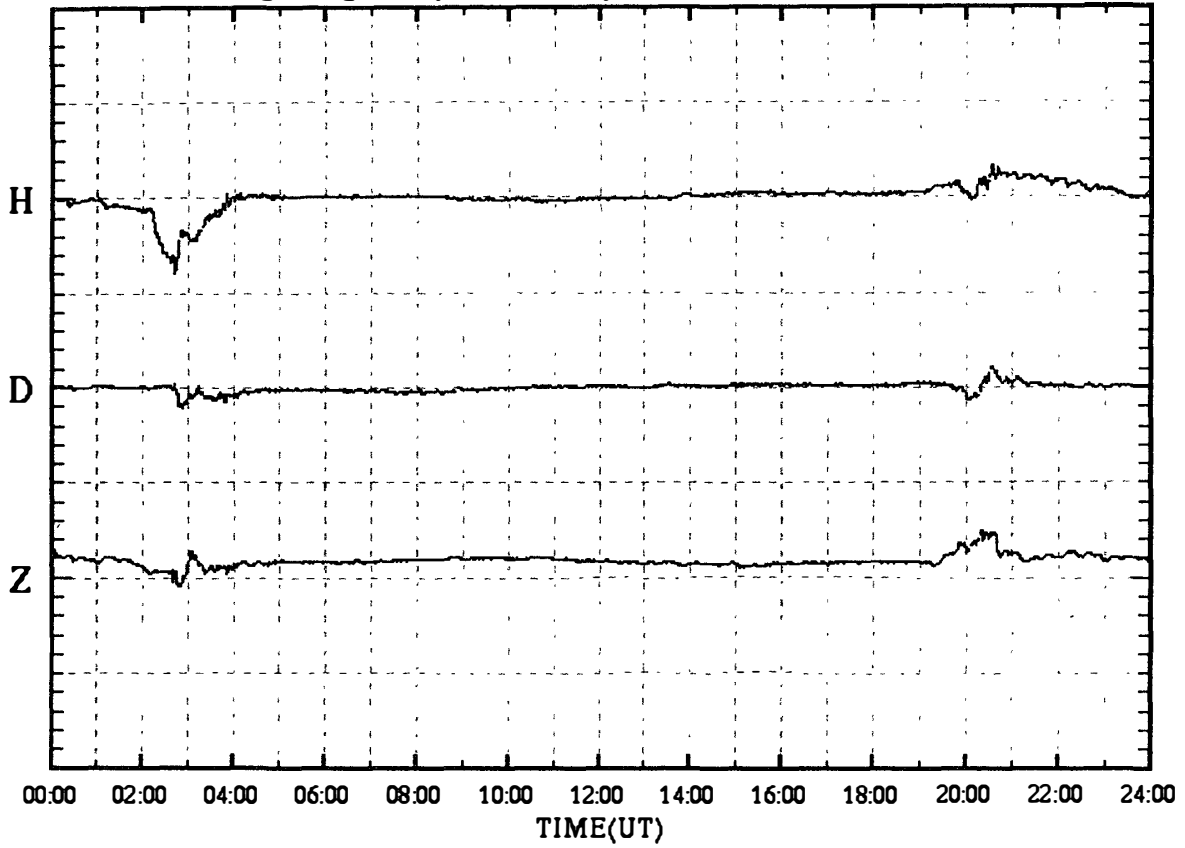

SYOWA magnetogram (100 nT/div)

15 May 2000 (DAY:136)

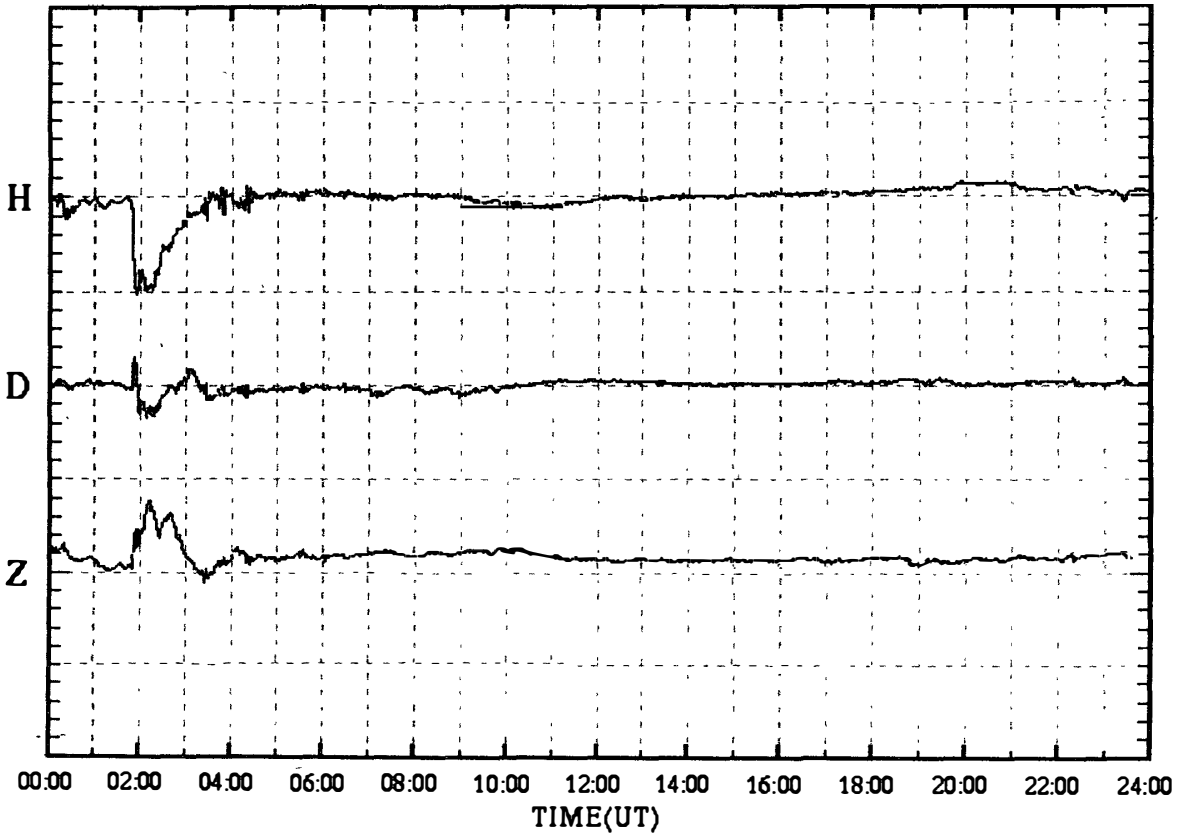

SYOWA magnetogram (100 nT/div)

16 May 2000 (DAY:137)

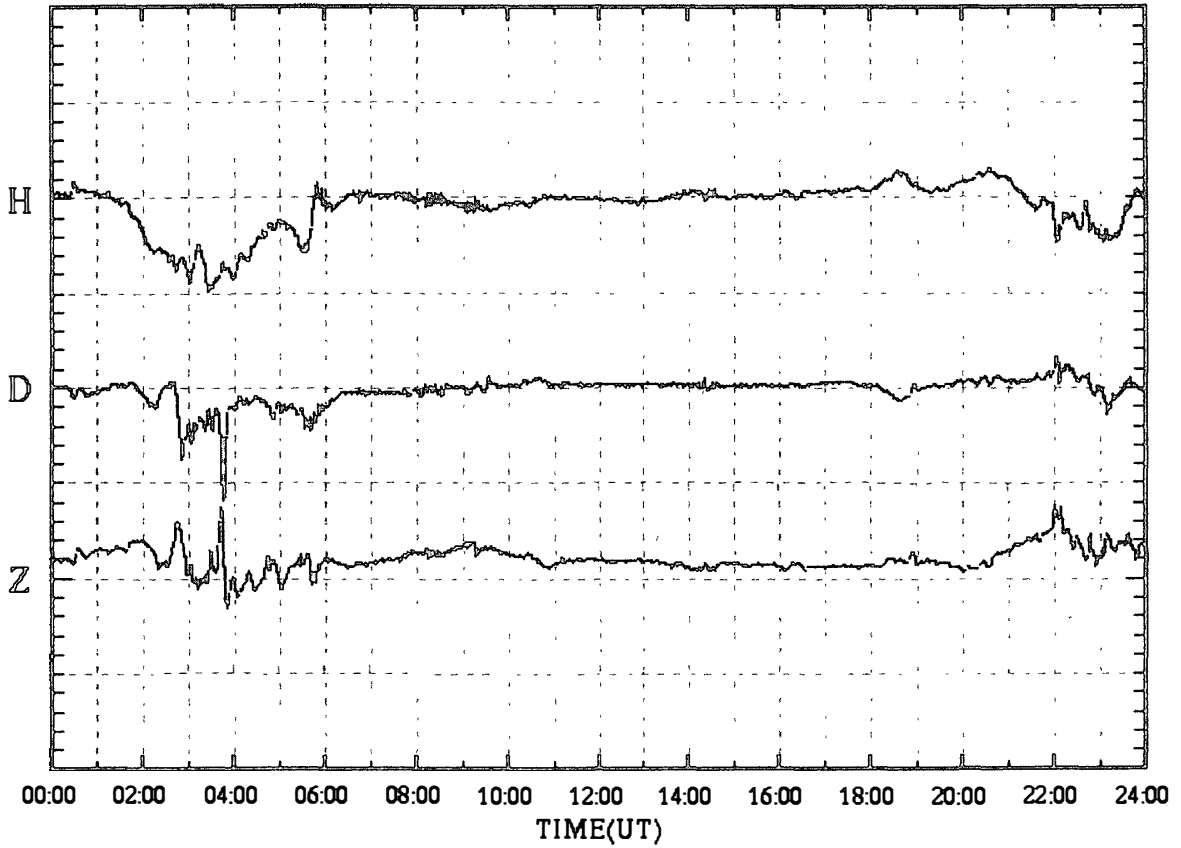

SYOWA magnetogram (100 nT/div)

17 May 2000 (DAY:138)

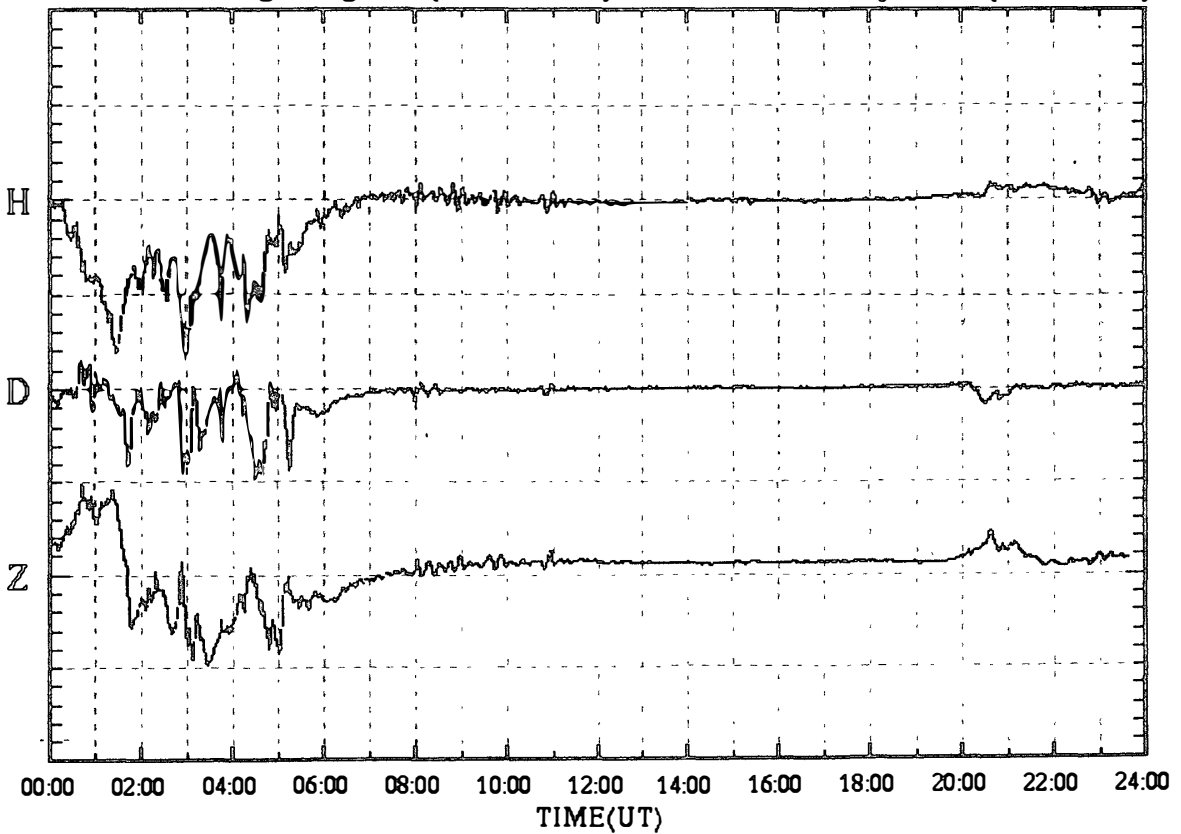

SYOWA magnetogram (100 nT/div)

18 May 2000 (DAY:139)

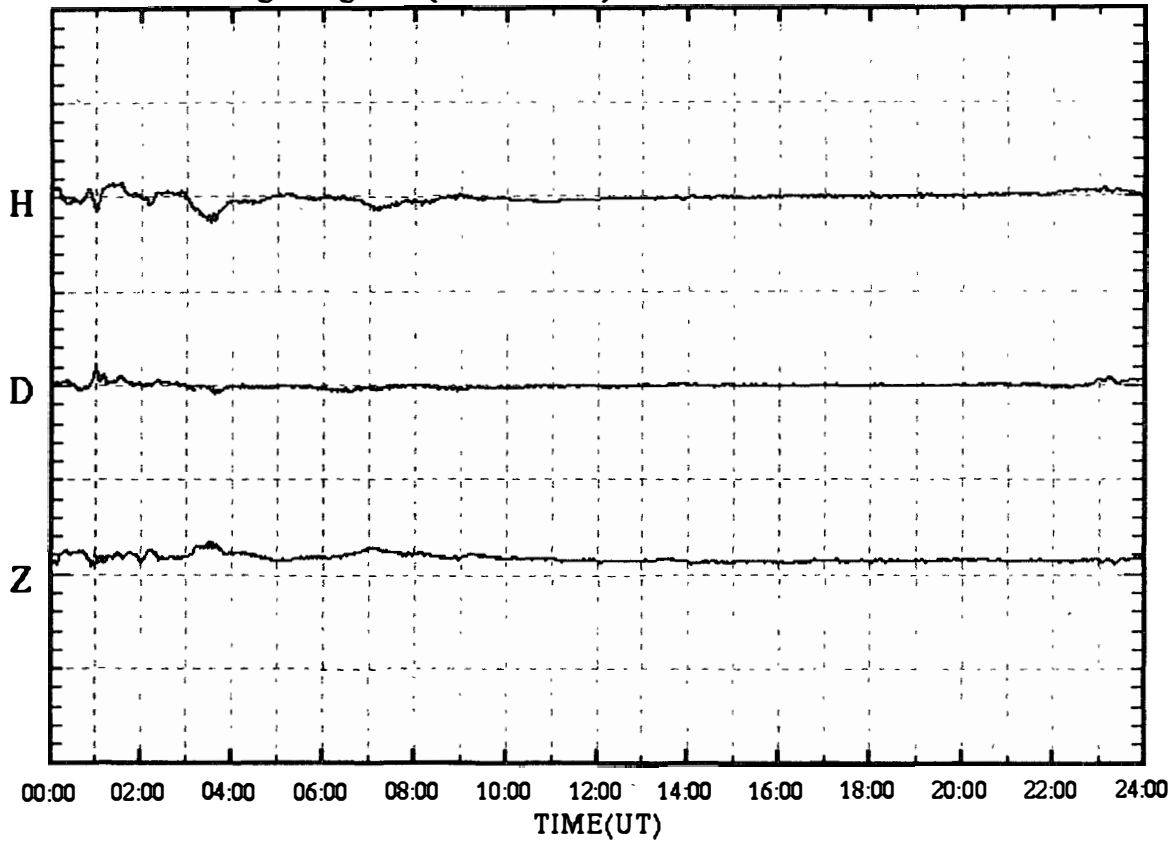

SYOWA magnetogram (100 nT/div)

19 May 2000 (DAY:140)

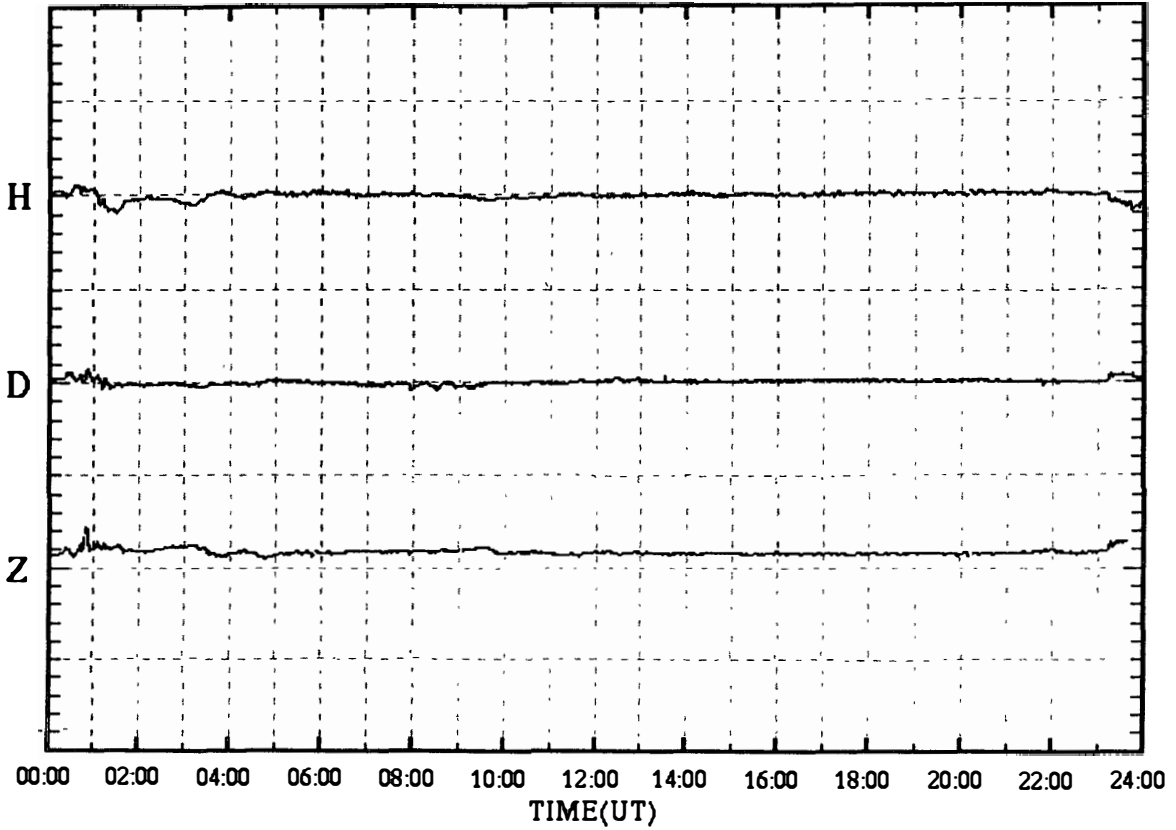

SYOWA magnetogram (100 nT/div)

20 May 2000 (DAY:141)

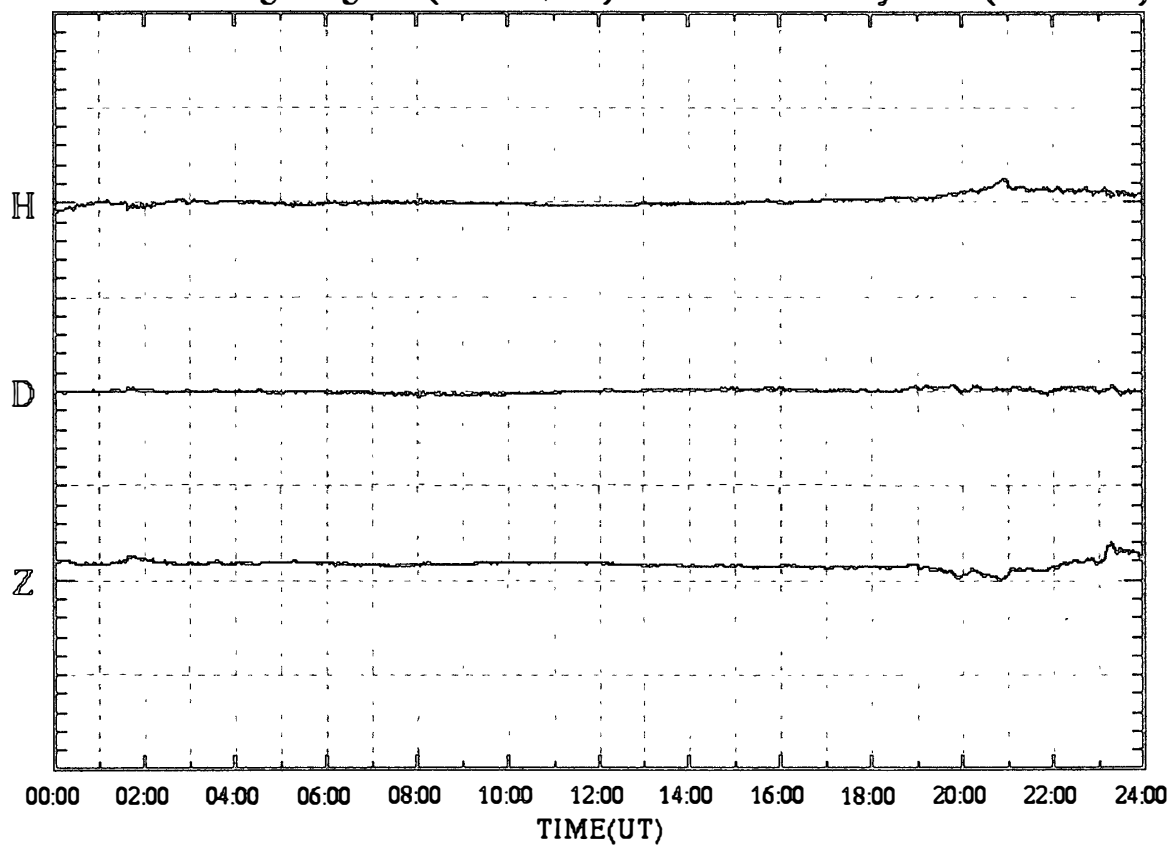

SYOWA magnetogram (100 nT/div)

21 May 2000 (DAY:142)

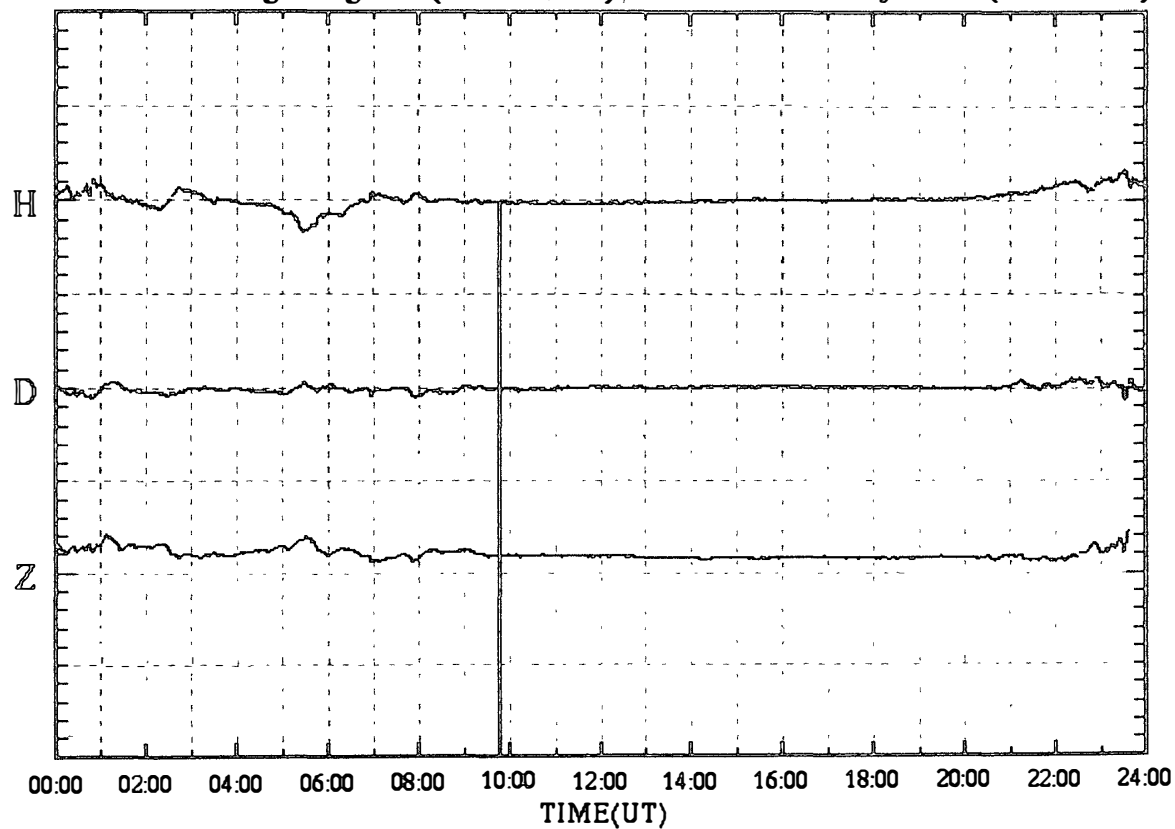

SYOWA magnetogram (100 nT/div)

22 May 2000 (DAY:143)

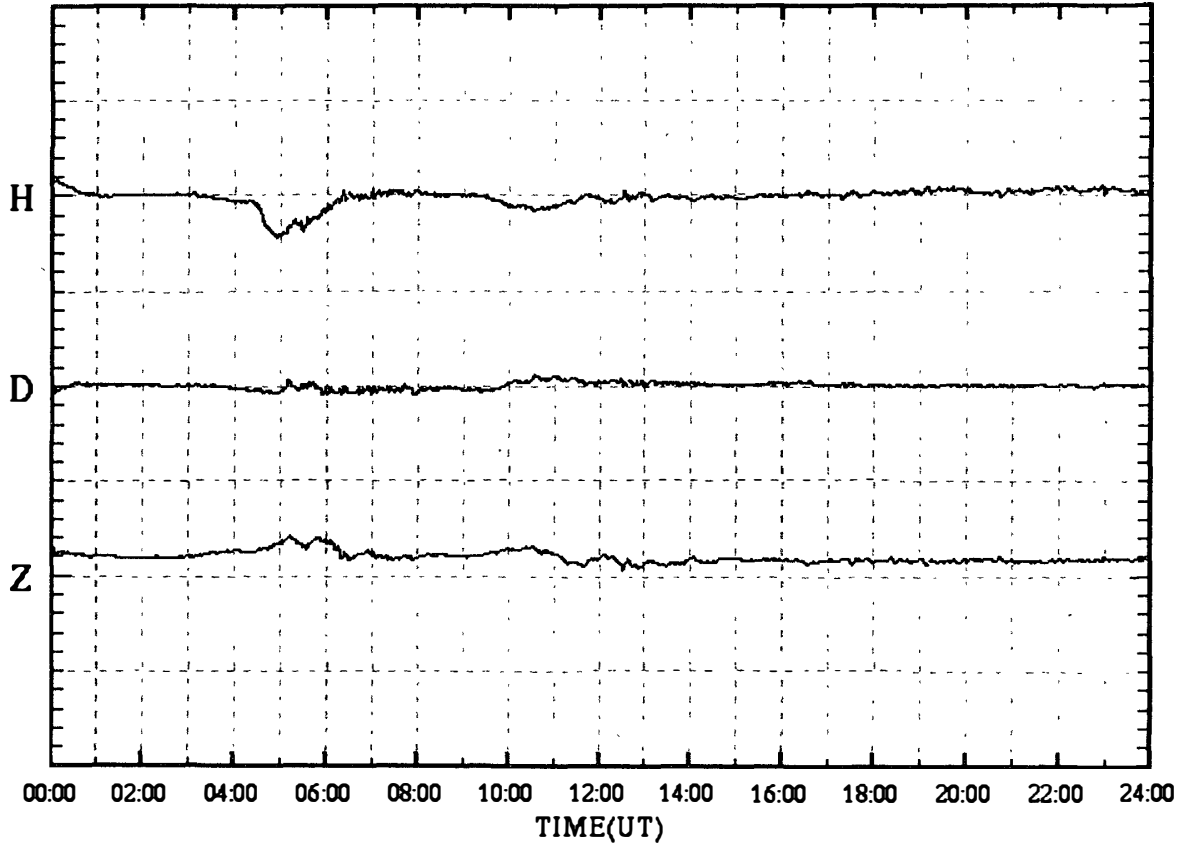

SYOWA magnetogram (100 nT/div)

23 May 2000 (DAY:144)

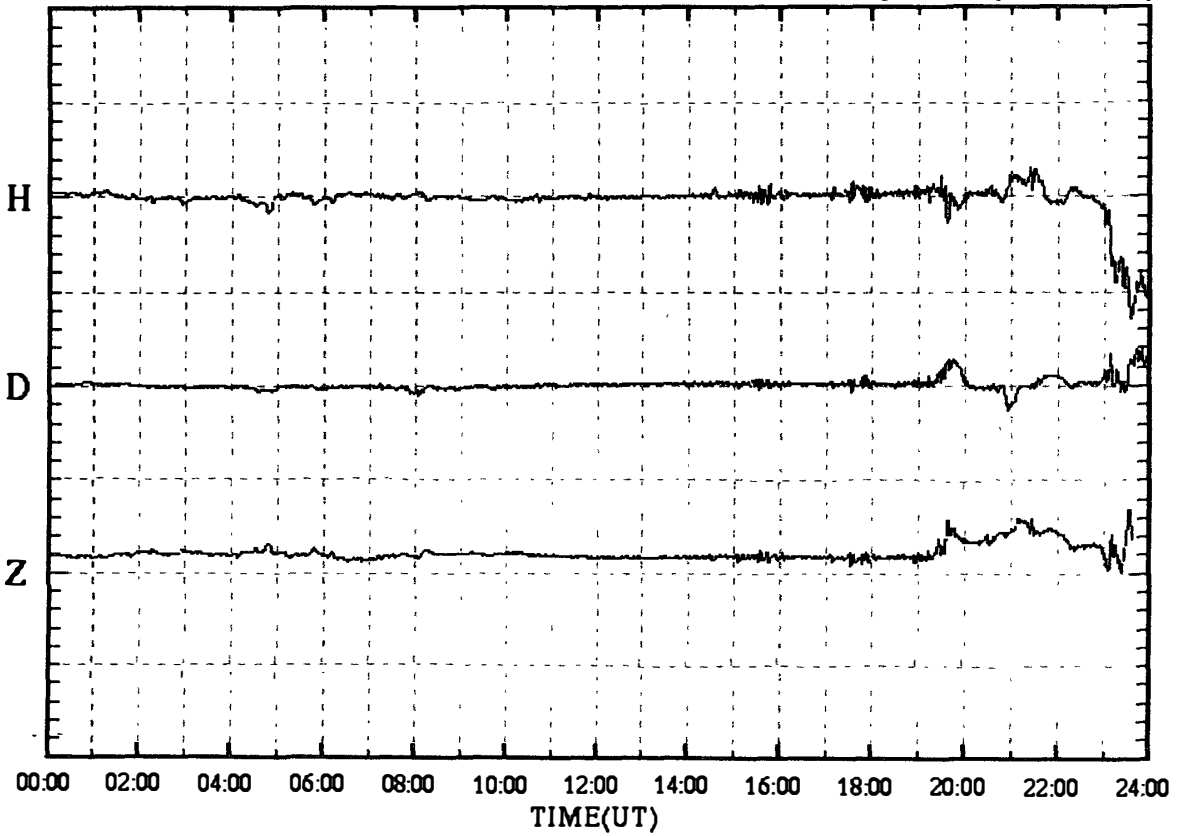

SYOWA magnetogram (100 nT/div)

24 May 2000 (DAY:145)

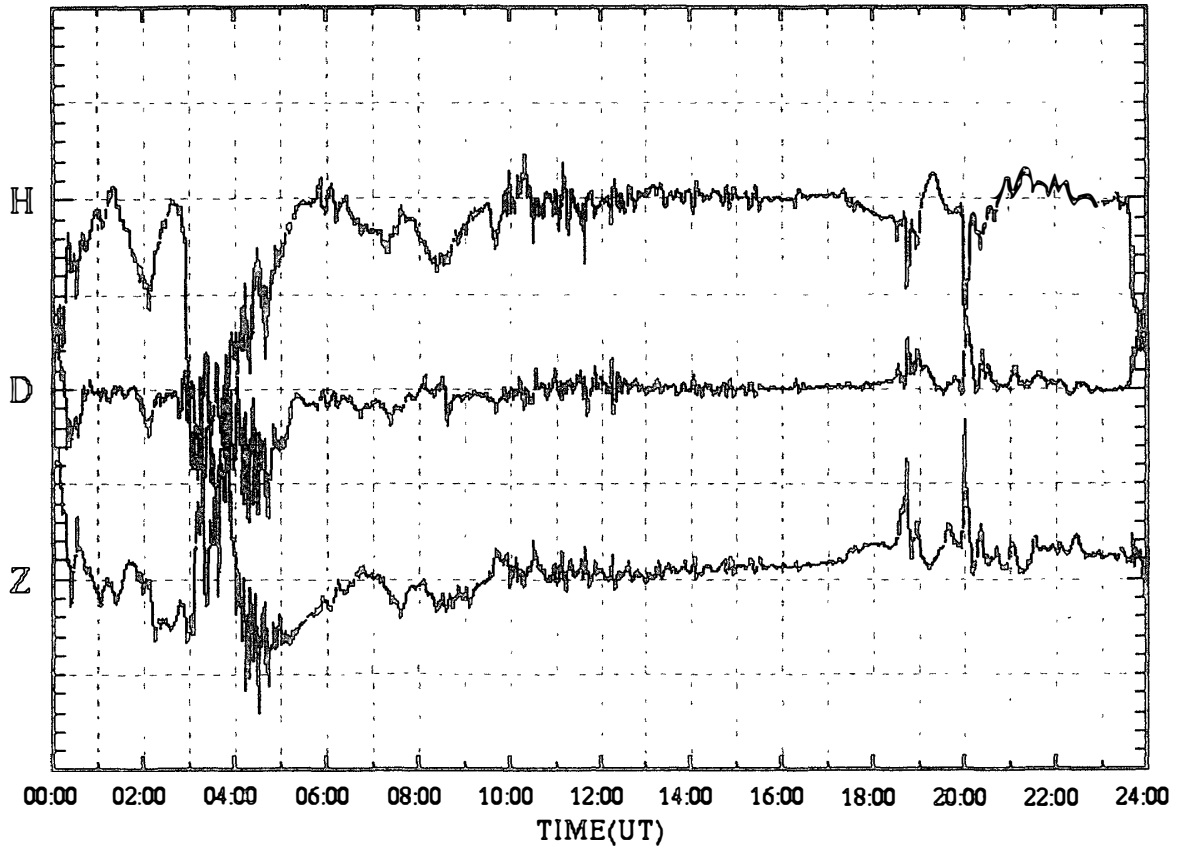

SYOWA magnetogram (100 nT/div)

25 May 2000 (DAY:146)

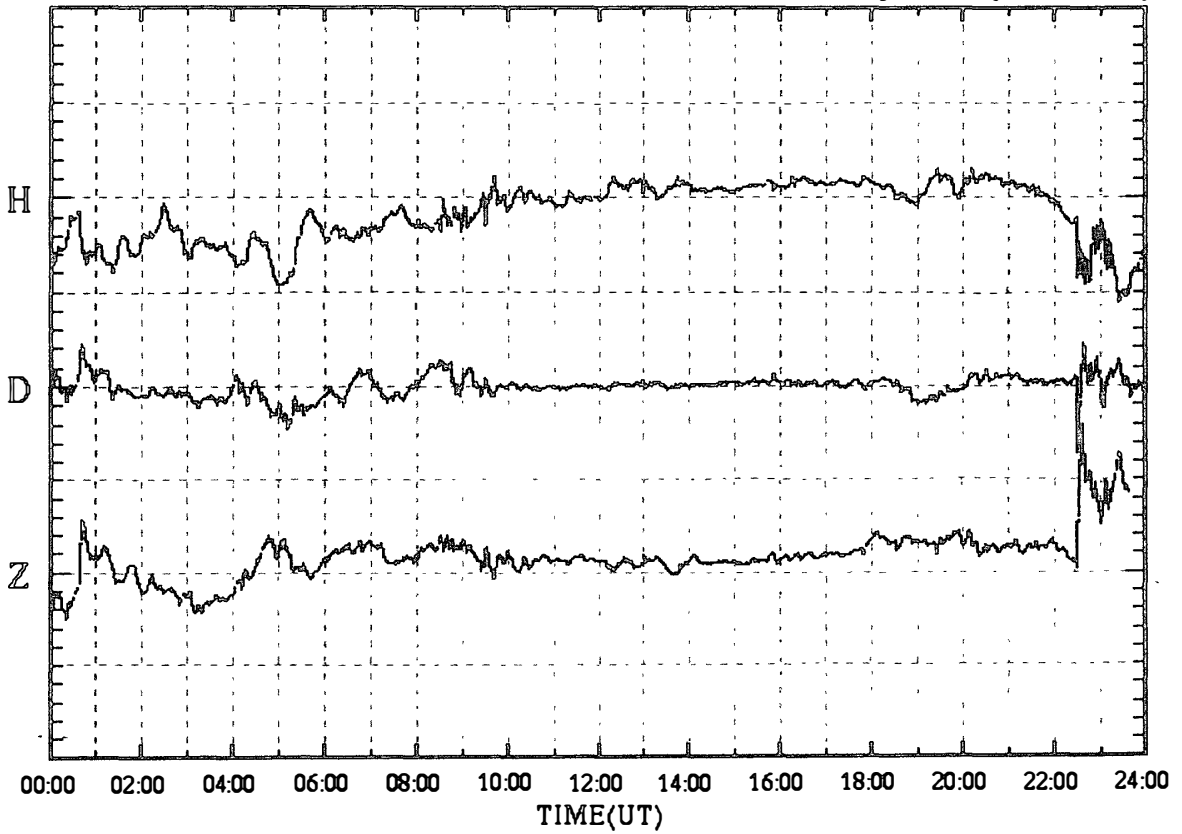

SYOWA magnetogram (100 nT/div)

26 May 2000 (DAY:147)

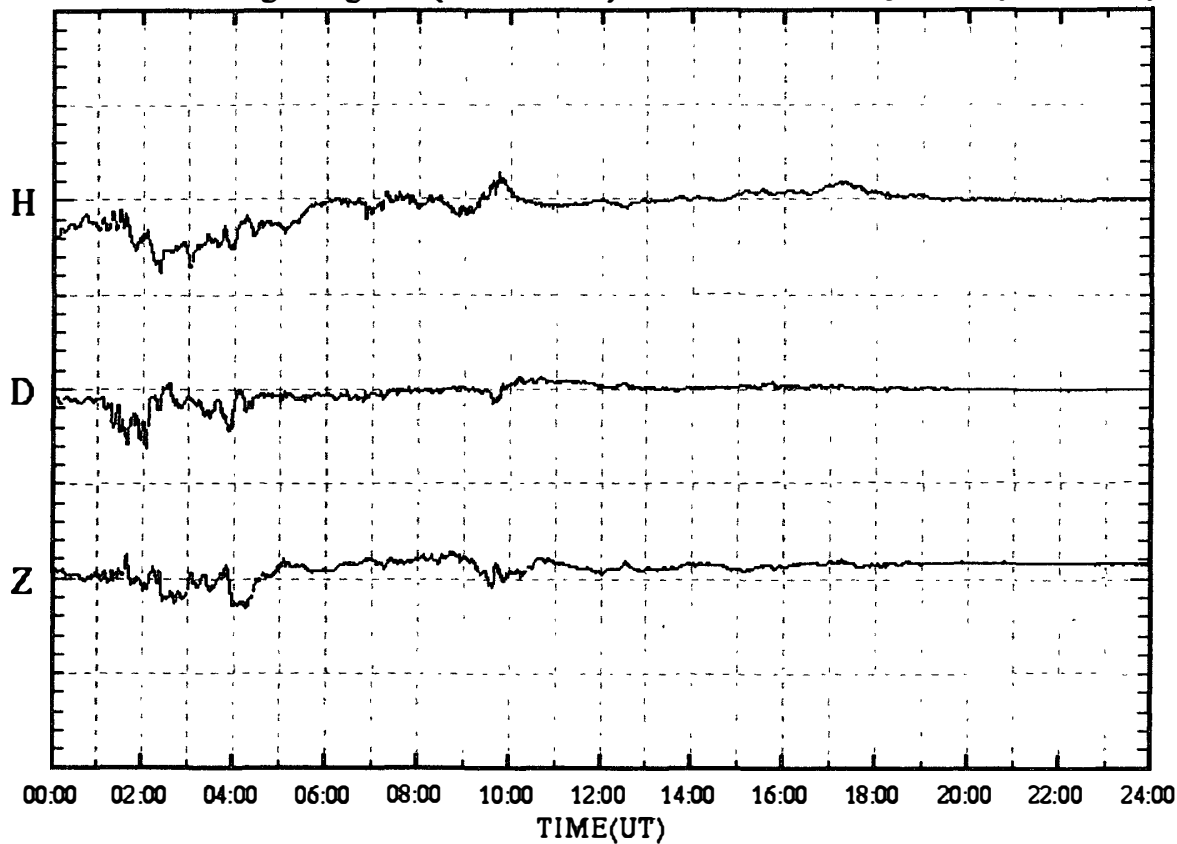

SYOWA magnetogram (100 nT/div)

27 May 2000 (DAY:148)

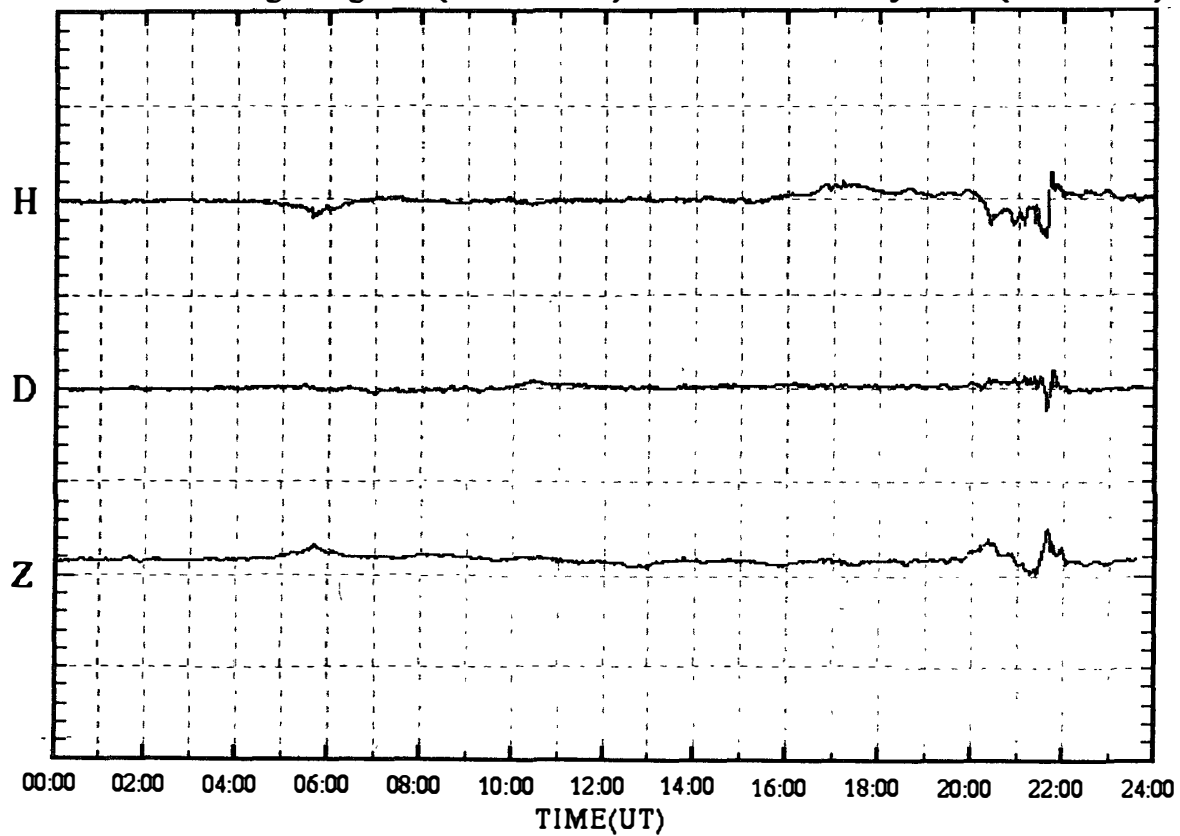

SYOWA magnetogram (100 nT/div)

28 May 2000 (DAY:149)

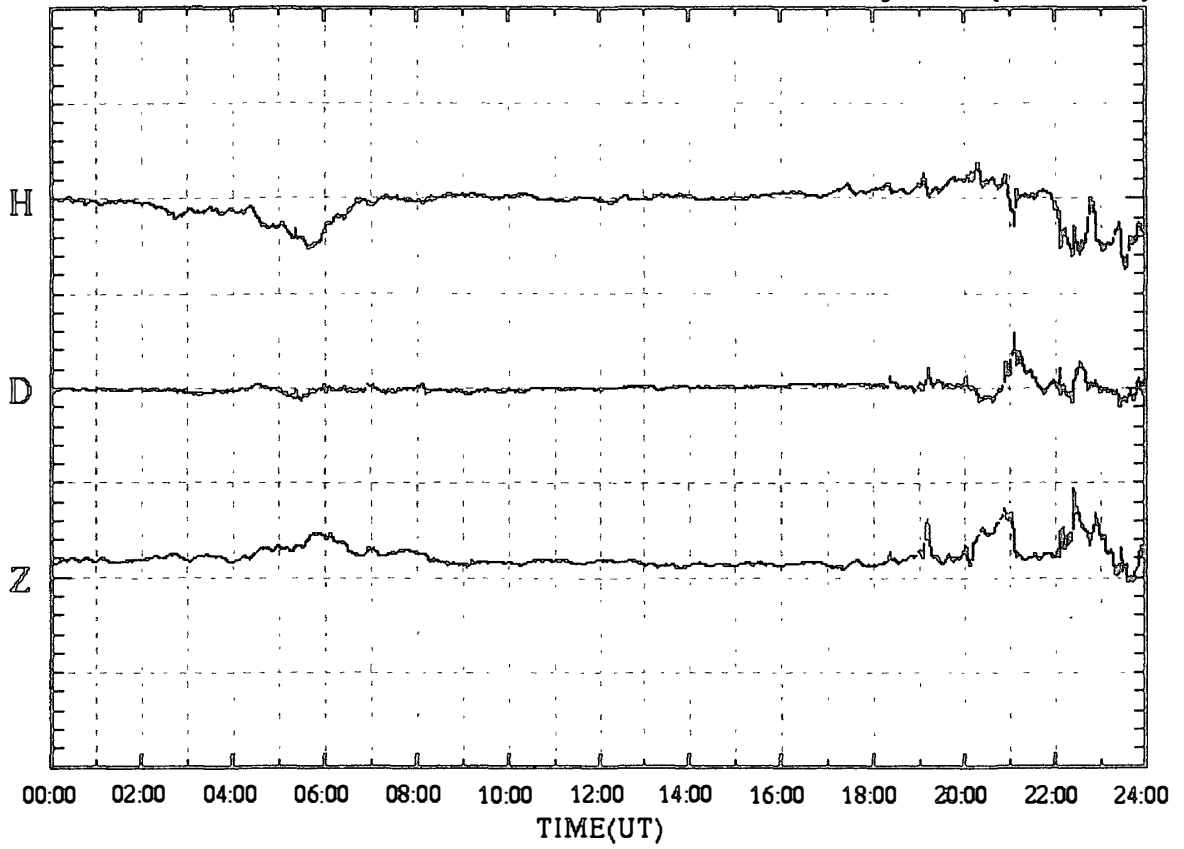

SYOWA magnetogram (100 nT/div)

29 May 2000 (DAY:150)

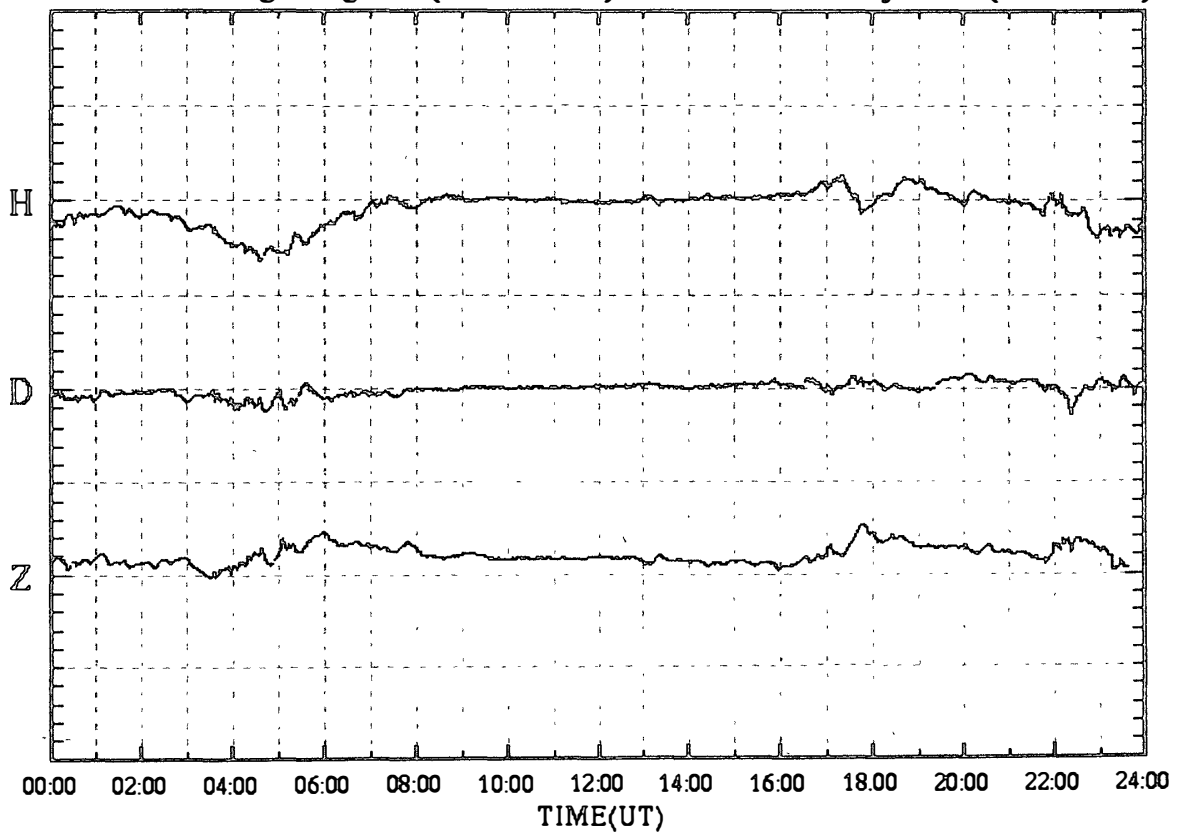

SYOWA magnetogram (100 nT/div)

30 May 2000 (DAY:151)

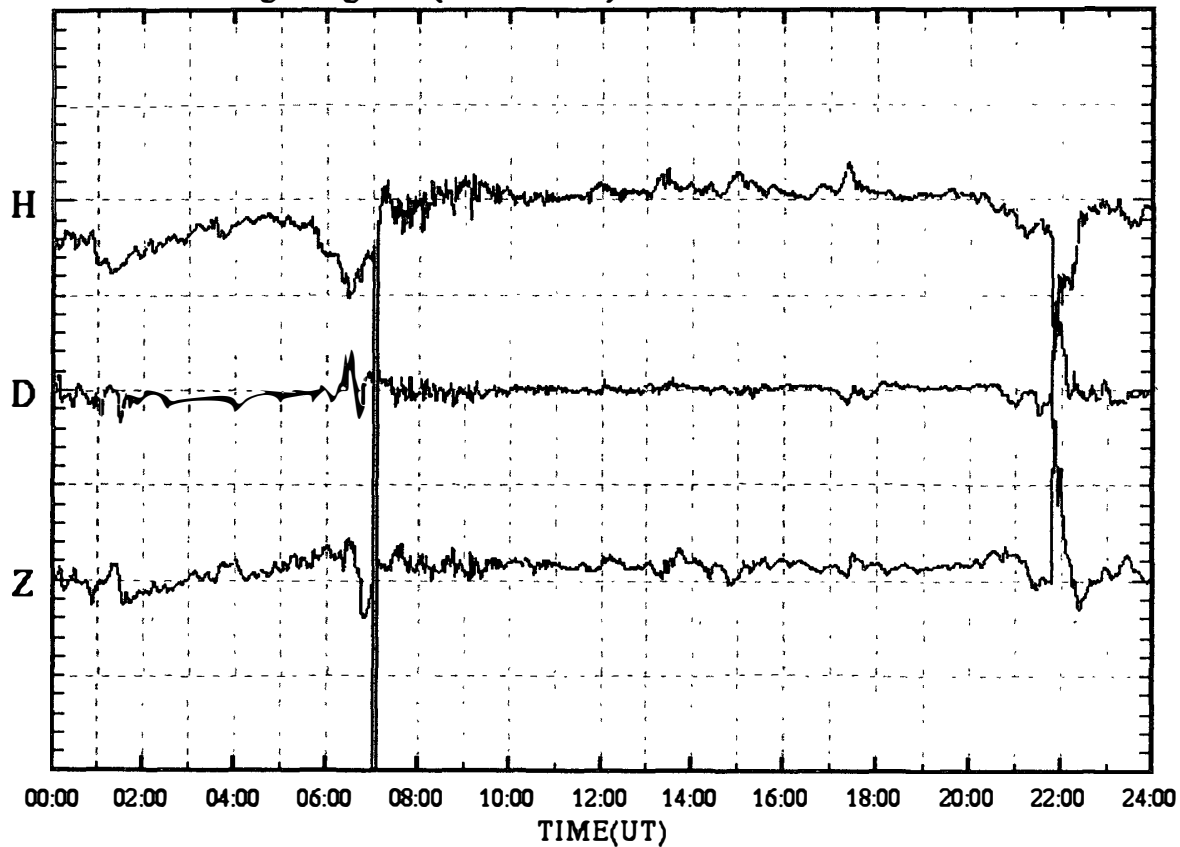

SYOWA magnetogram (100 nT/div)

31 May 2000 (DAY:152)

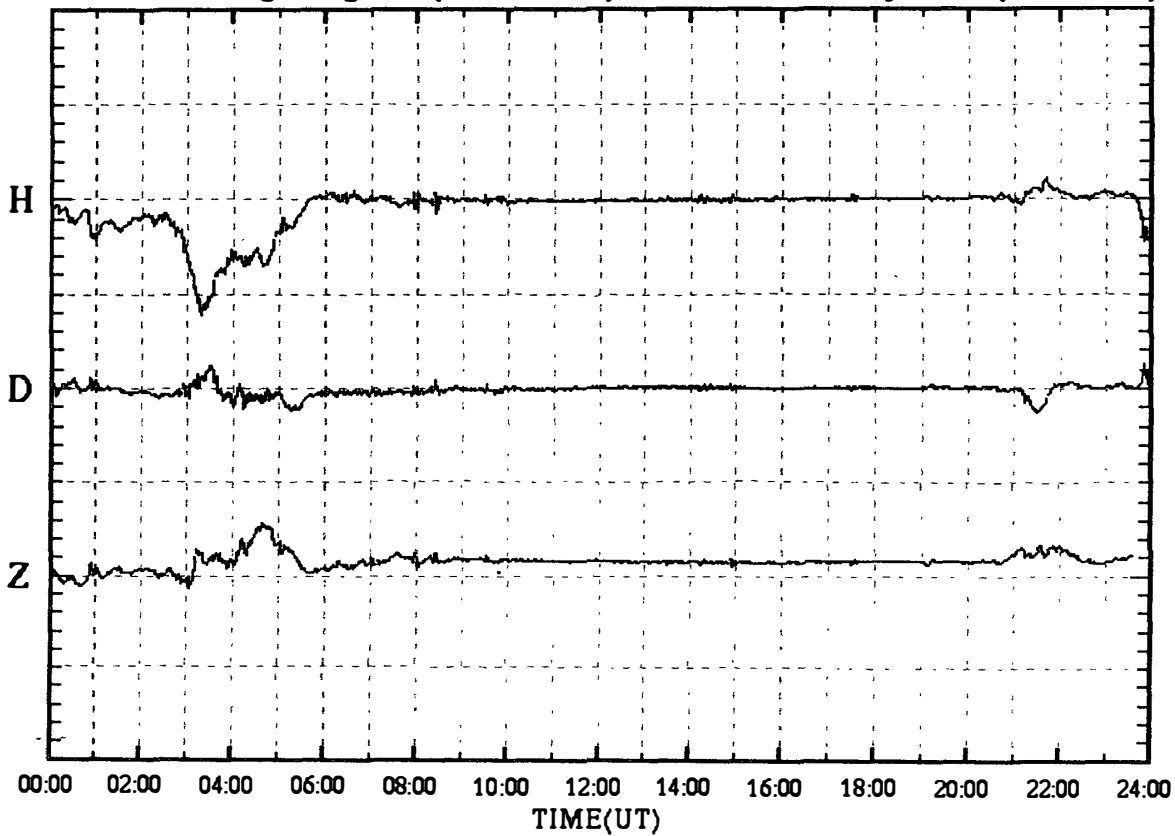

SYOWA magnetogram (100 nT/div)

01 Jun.2000 (DAY:153)

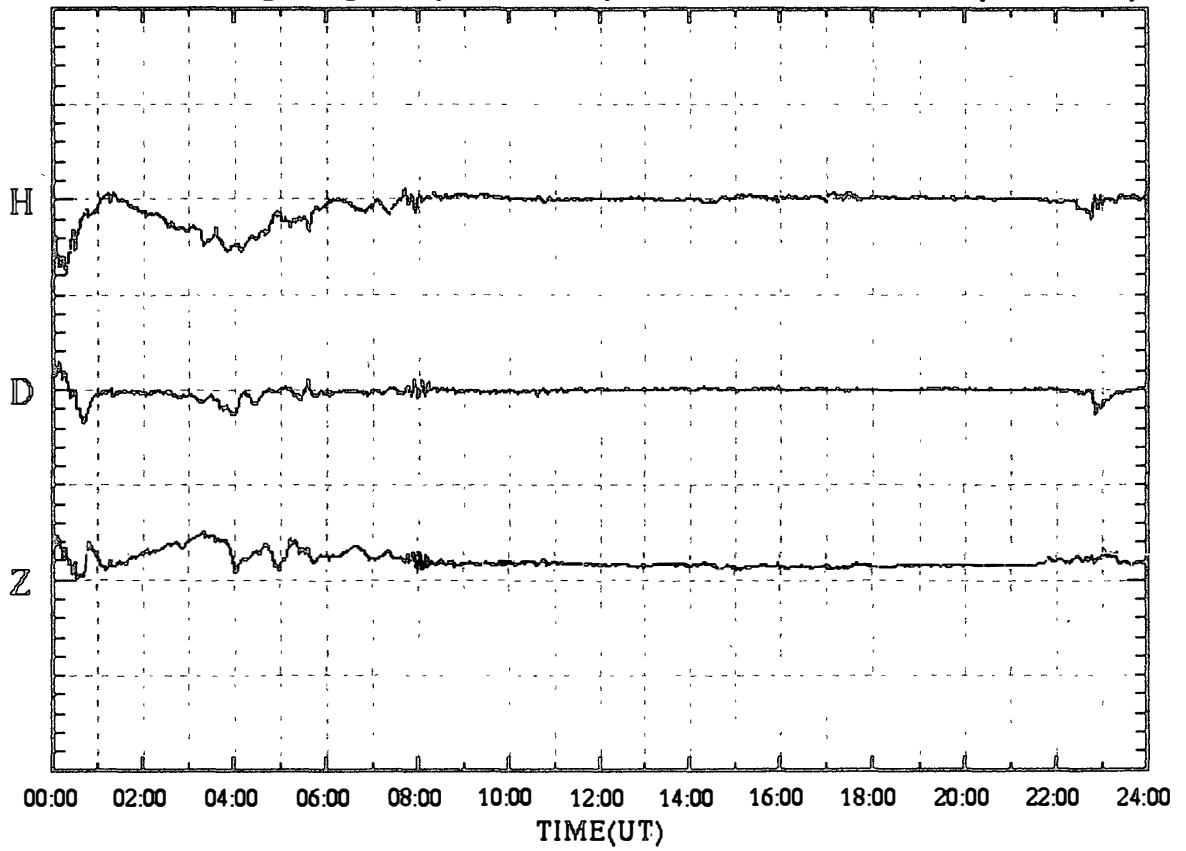

SYOWA magnetogram (100 nT/div)

02 Jun.2000 (DAY:154)

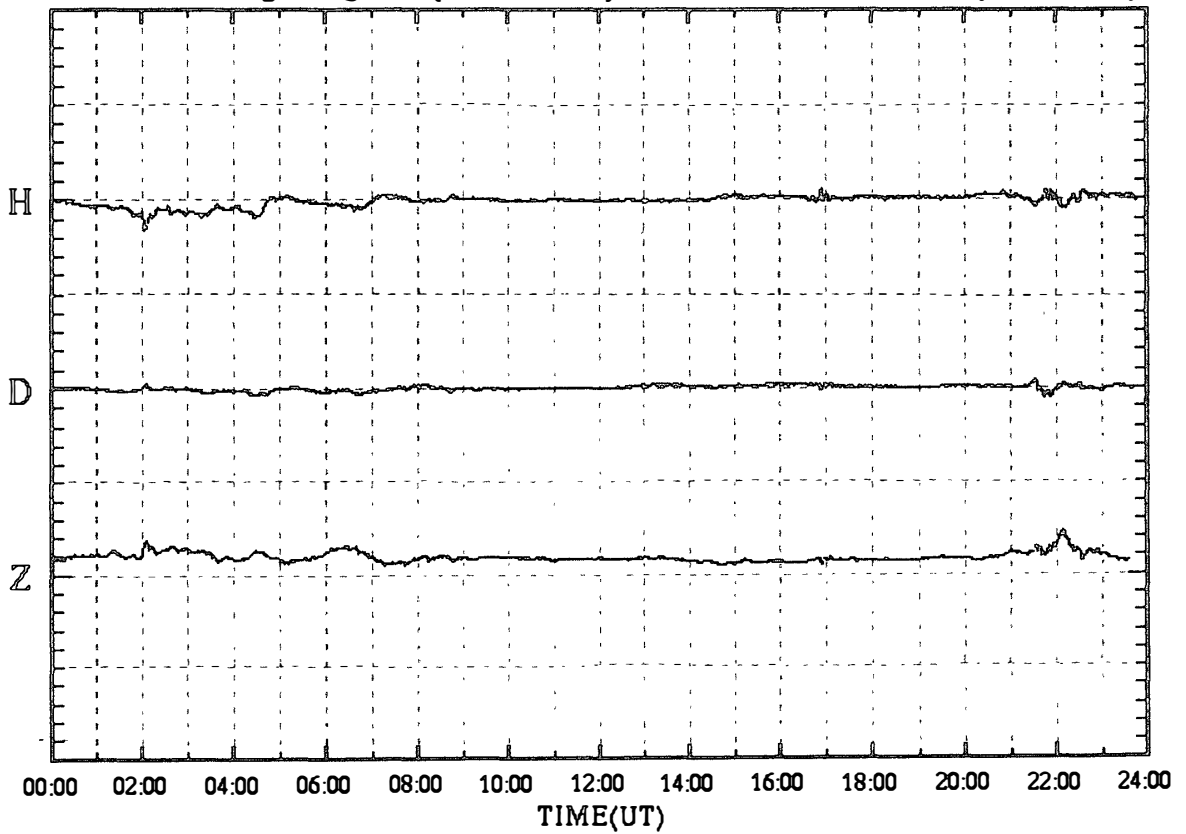

SYOWA magnetogram (100 nT/div)

03 Jun.2000 (DAY:155)

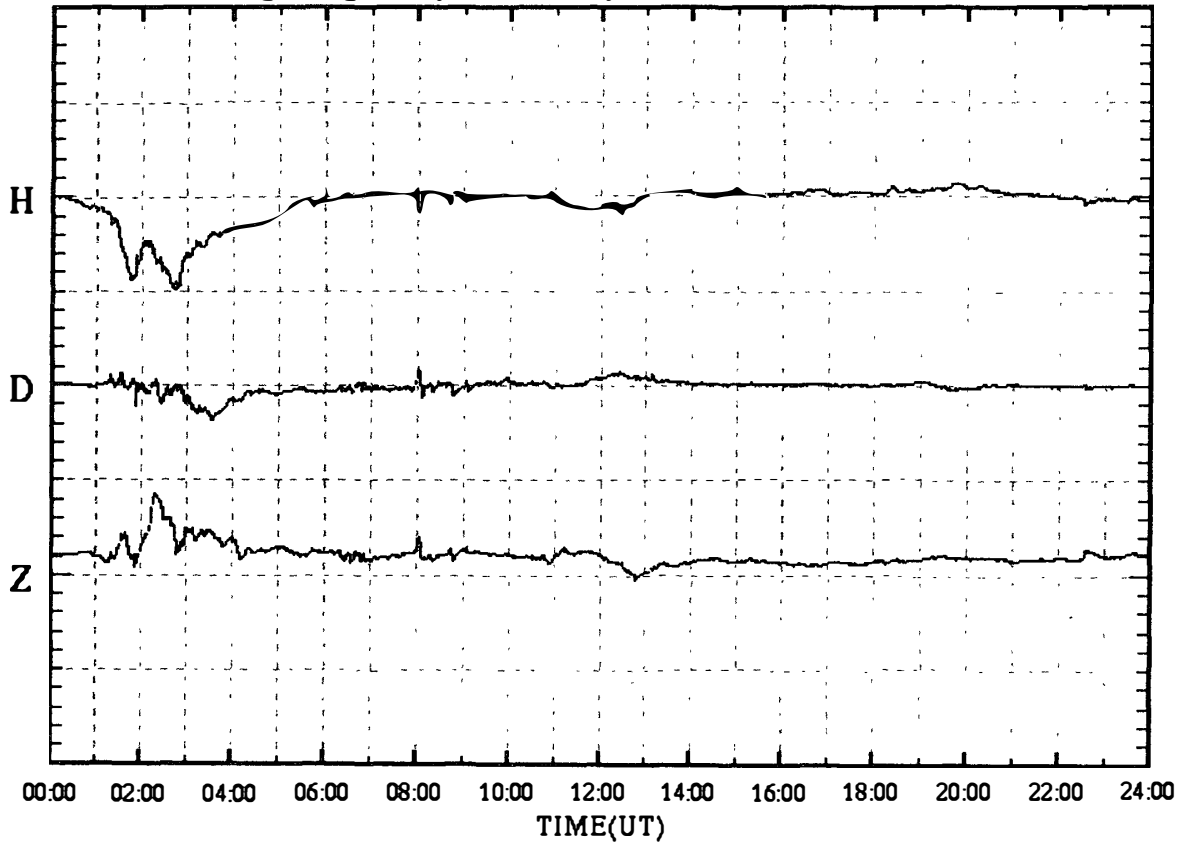

SYOWA magnetogram (100 nT/div)

04 Jun.2000 (DAY:156)

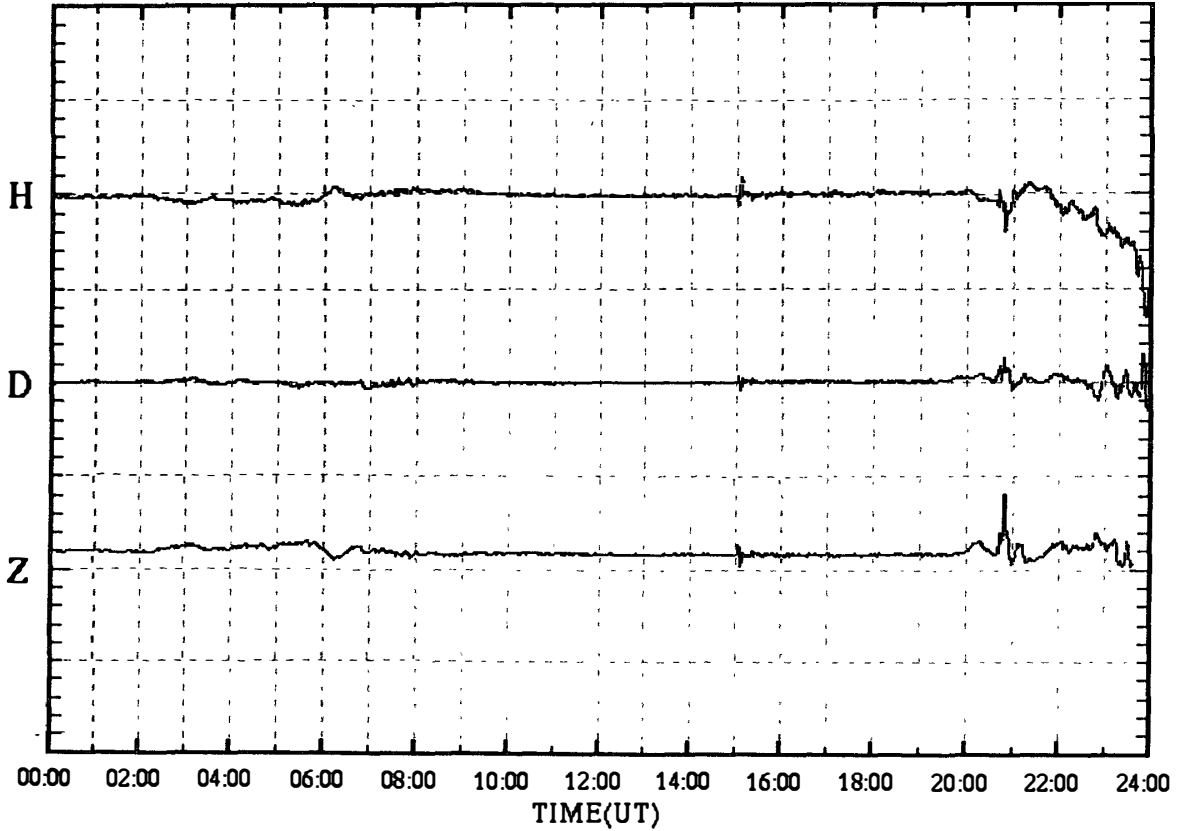

SYOWA magnetogram (100 nT/div)

05 Jun.2000 (DAY:157)

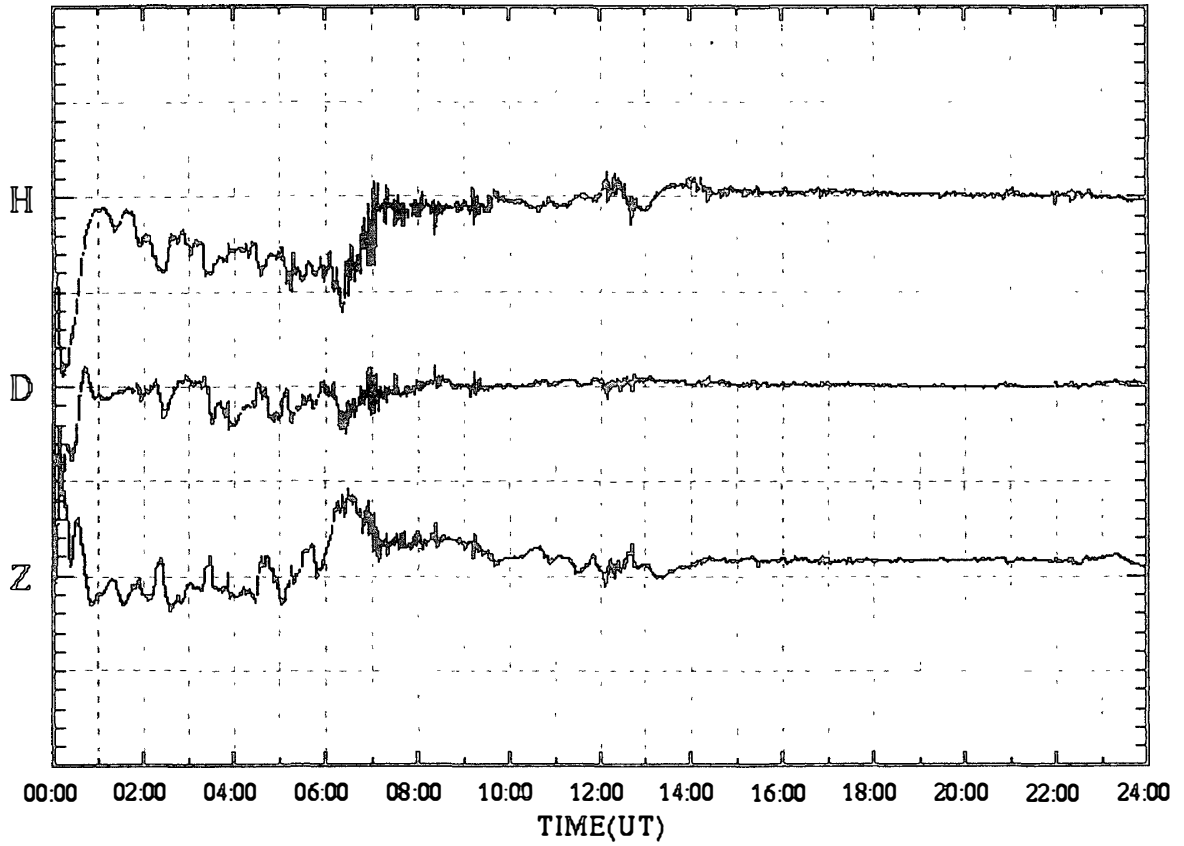

SYOWA magnetogram (100 nT/div)

06 Jun.2000 (DAY:158)

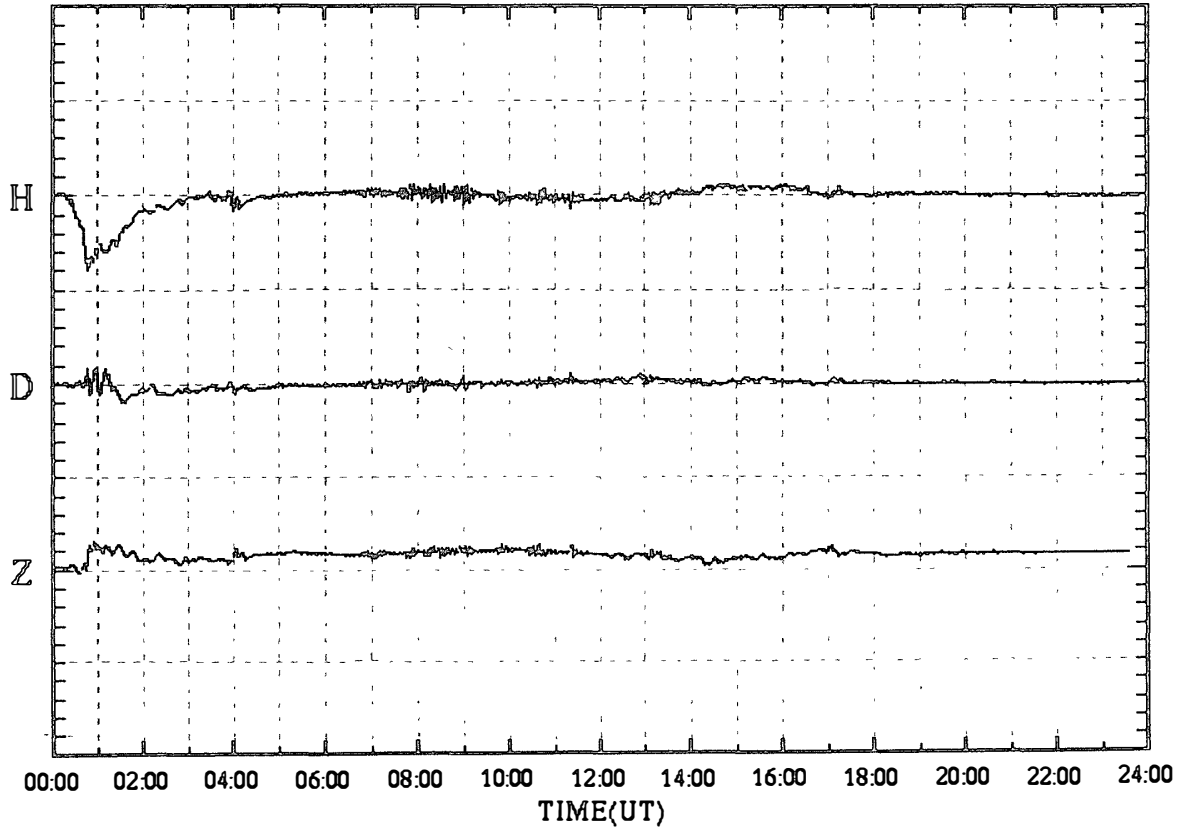

SYOWA magnetogram (100 nT/div)

07 Jun.2000 (DAY:159)

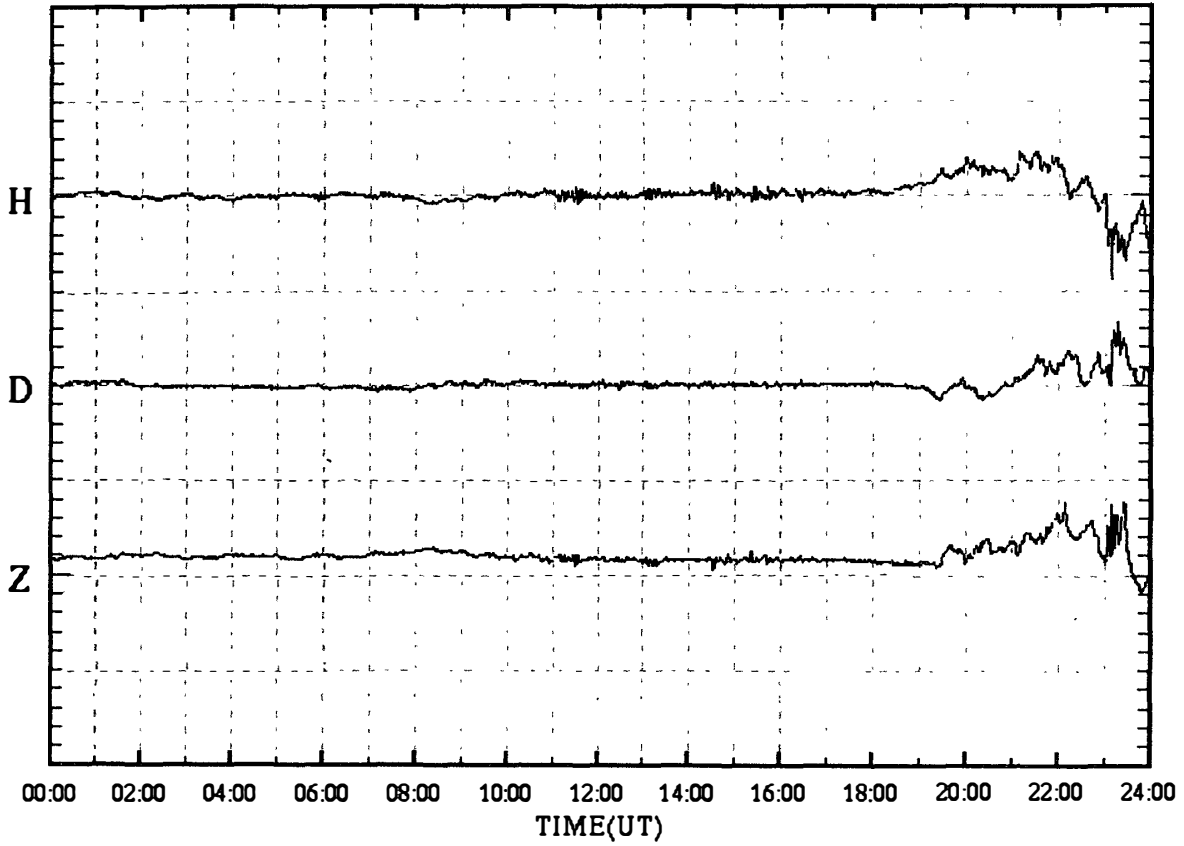

SYOWA magnetogram (100 nT/div)

08 Jun.2000 (DAY:160)

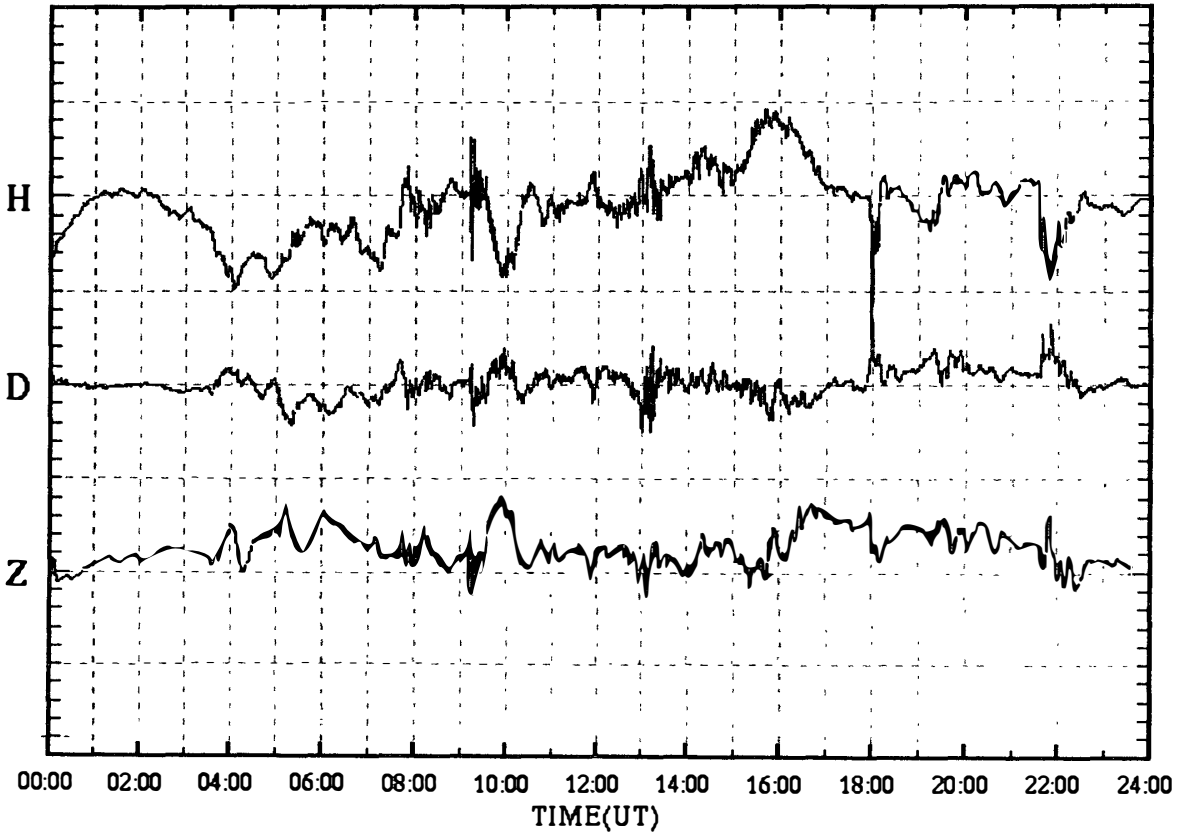

SYOWA magnetogram (100 nT/div)

09 Jun.2000 (DAY:161)

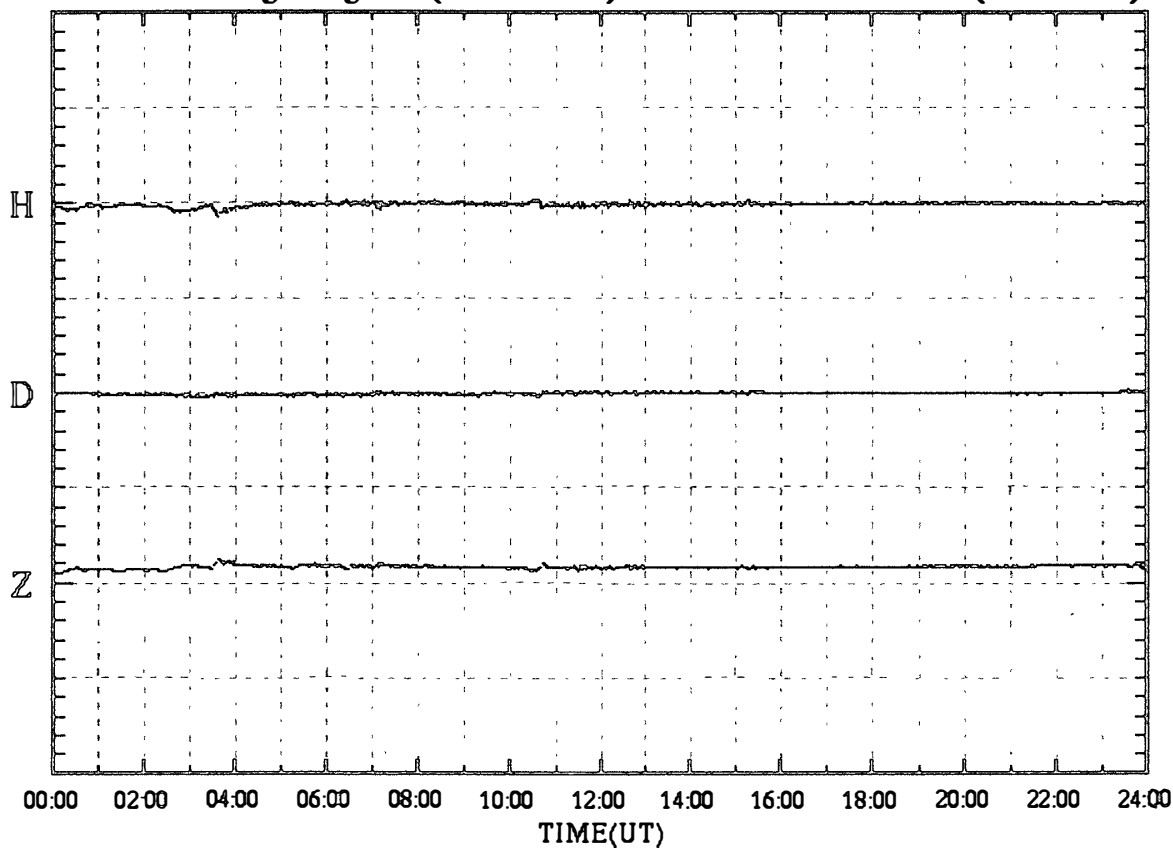

SYOWA magnetogram (100 nT/div)

10 Jun.2000 (DAY:162)

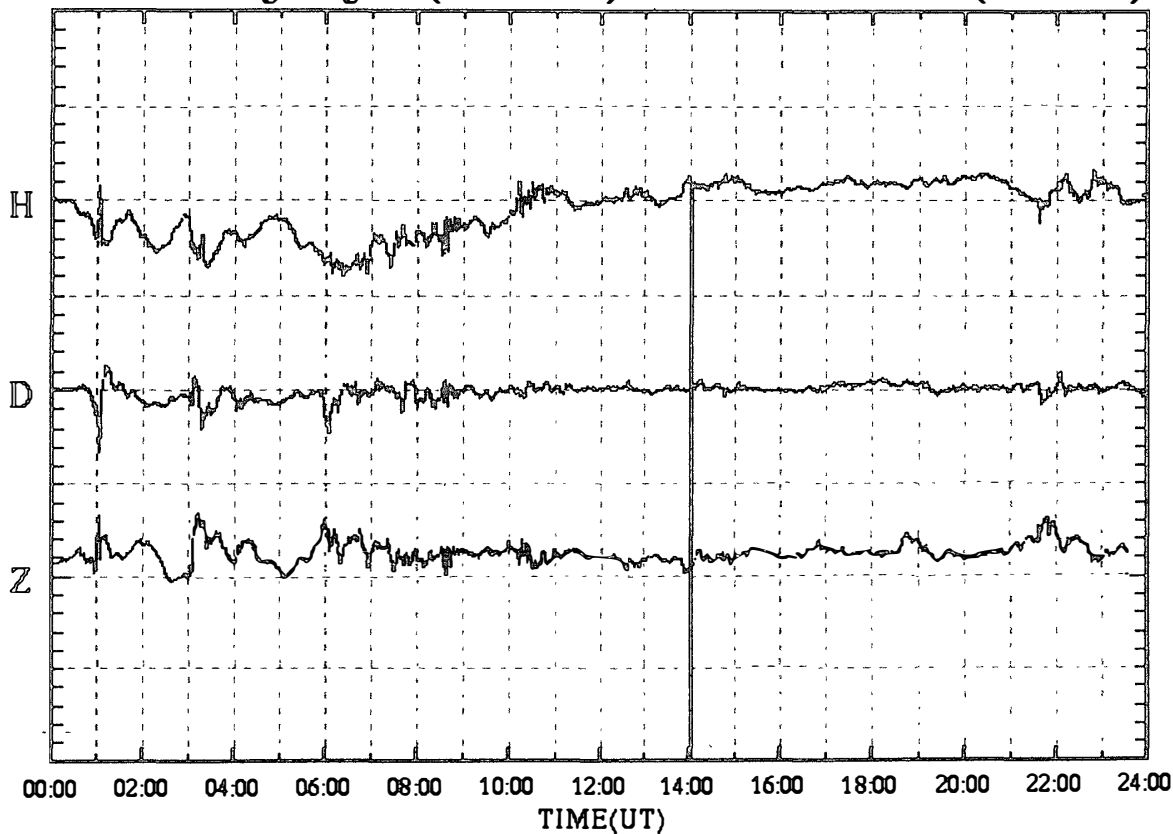

SYOWA magnetogram (100 nT/div)

11 Jun.2000 (DAY:163)

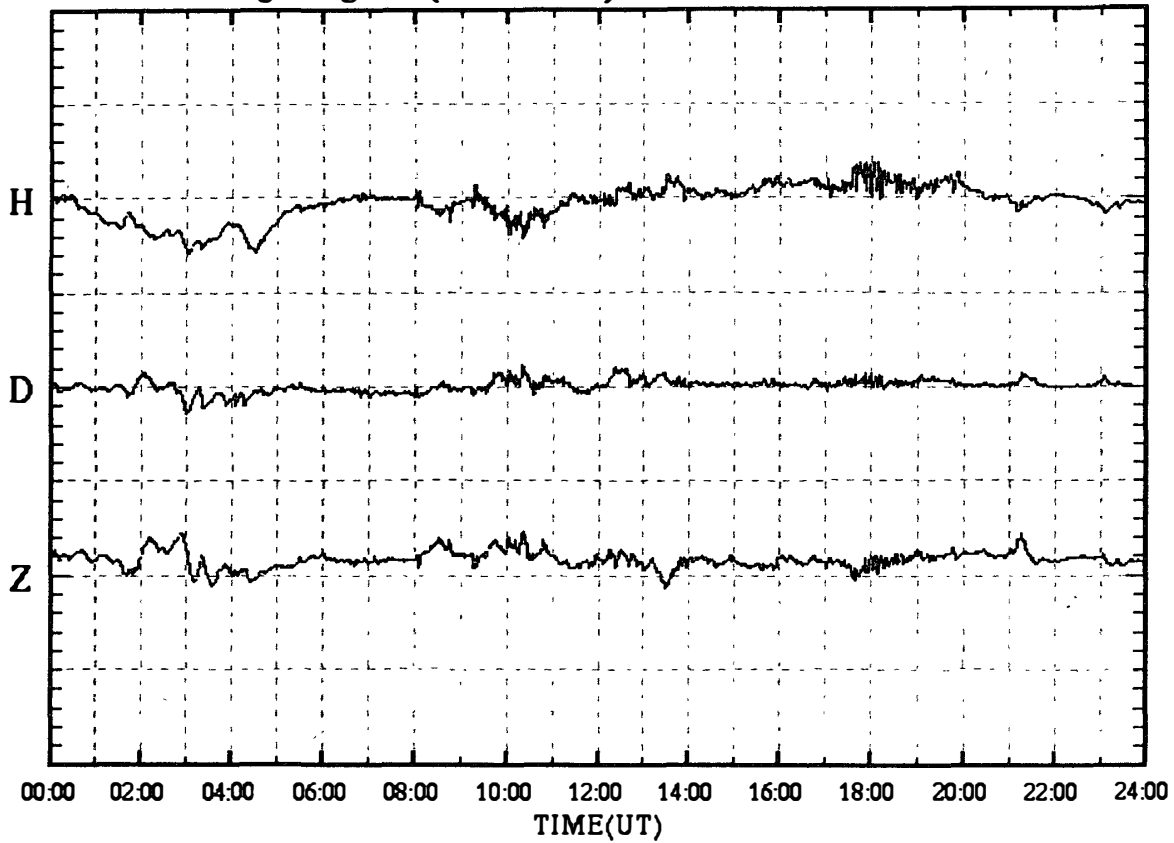

SYOWA magnetogram (100 nT/div)

12 Jun.2000 (DAY:164)

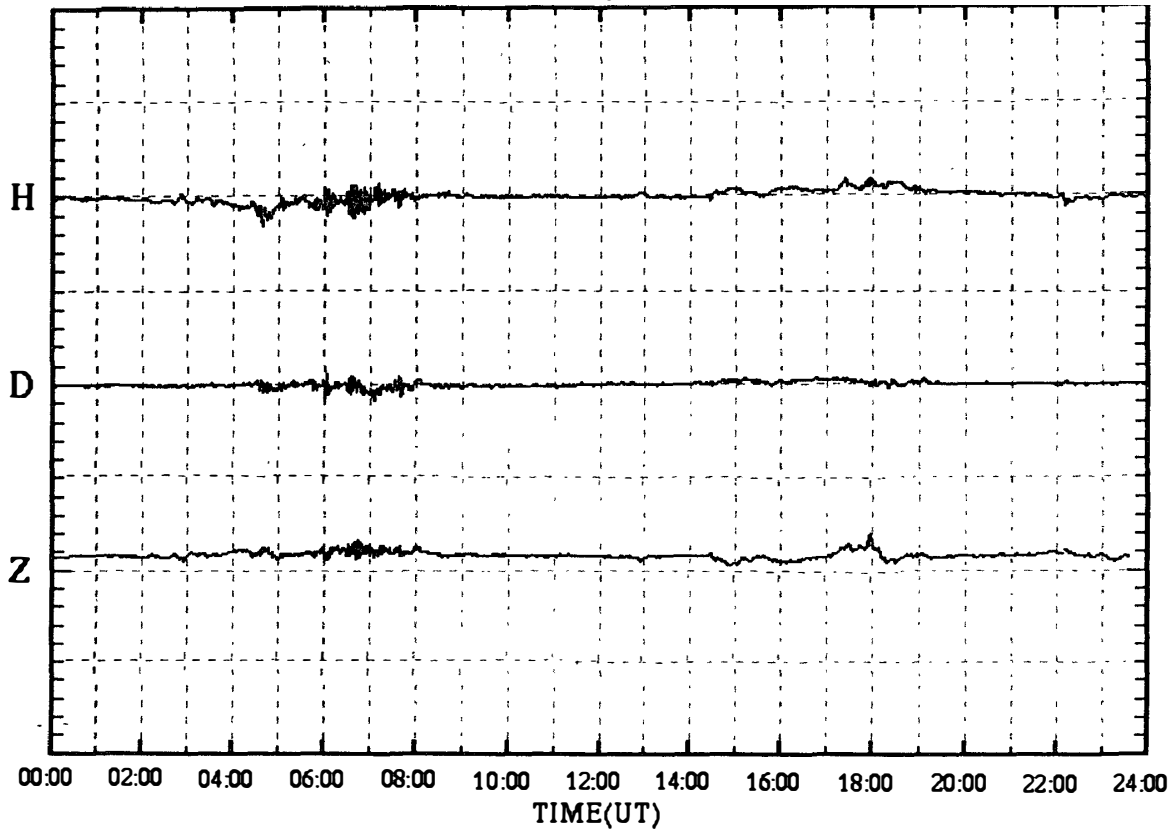

SYOWA magnetogram (100 nT/div)

13 Jun.2000 (DAY:165)

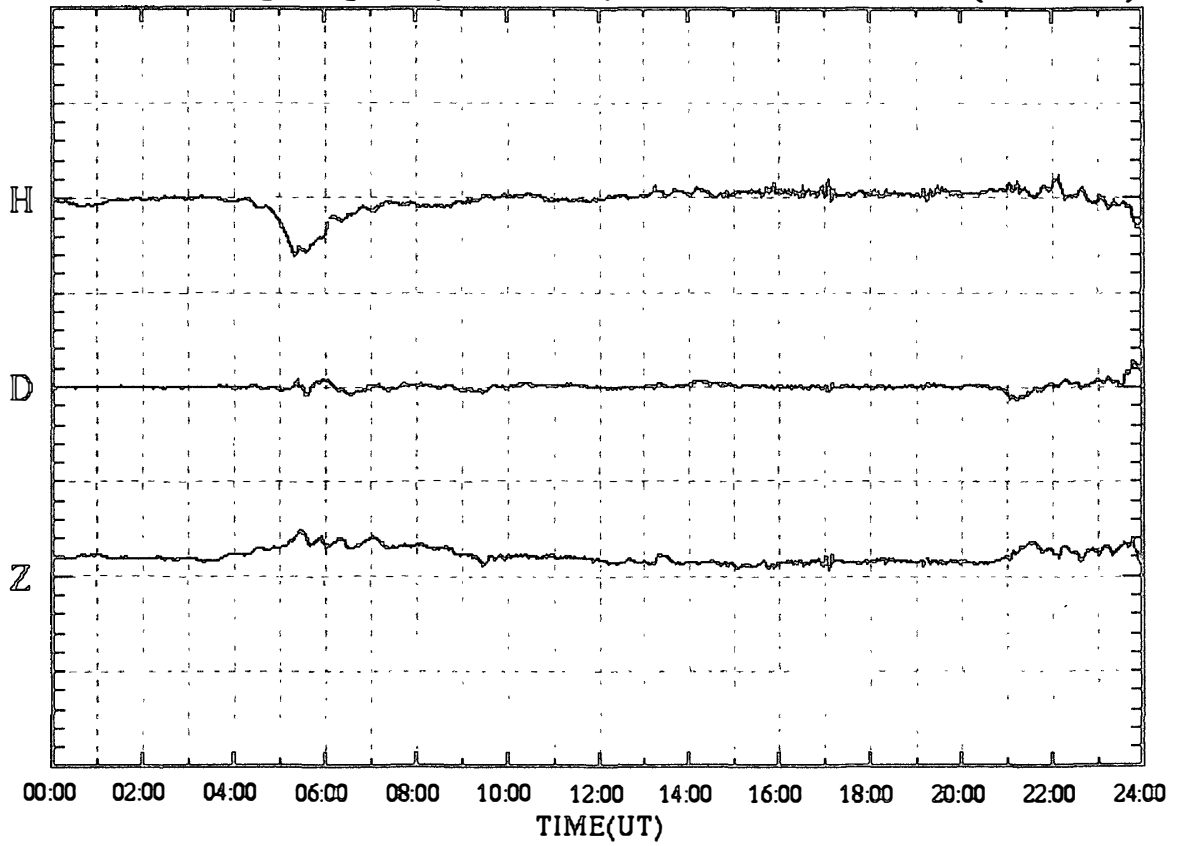

SYOWA magnetogram (100 nT/div)

14 Jun.2000 (DAY:166)

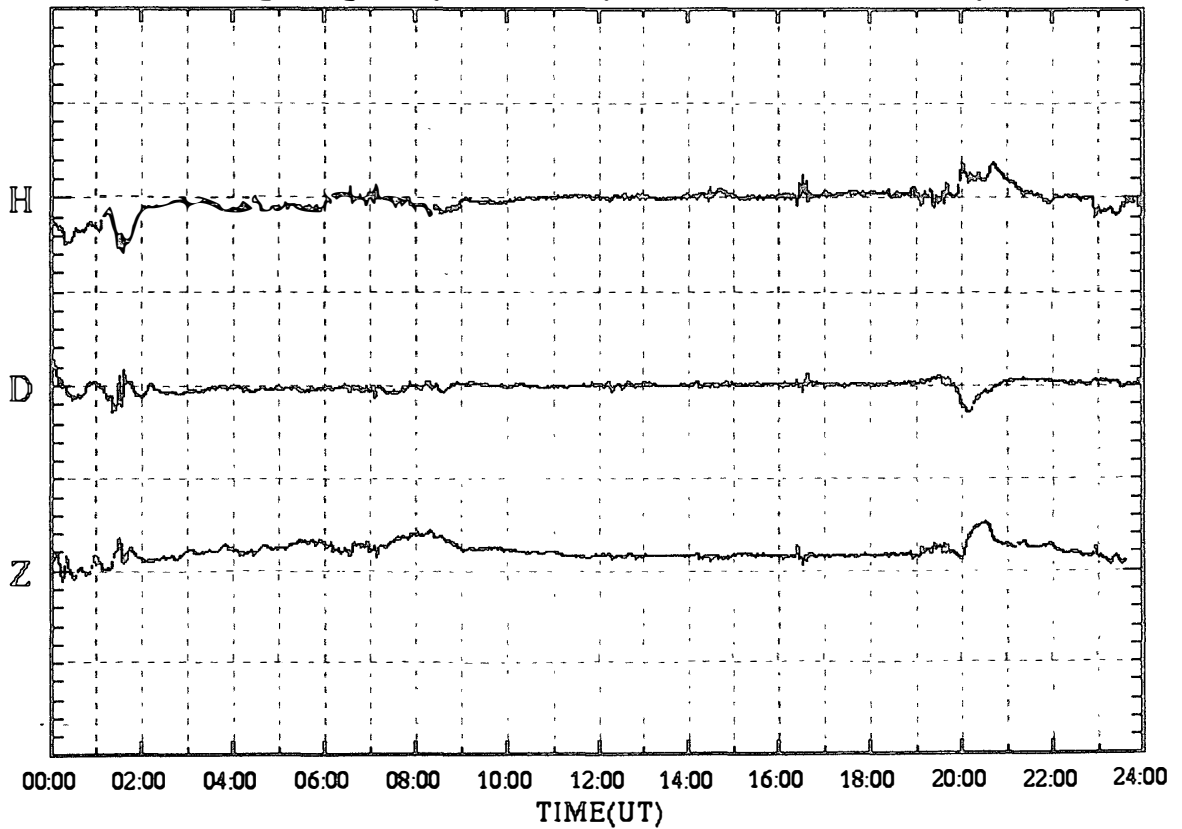

SYOWA magnetogram (100 nT/div)

15 Jun.2000 (DAY:167)

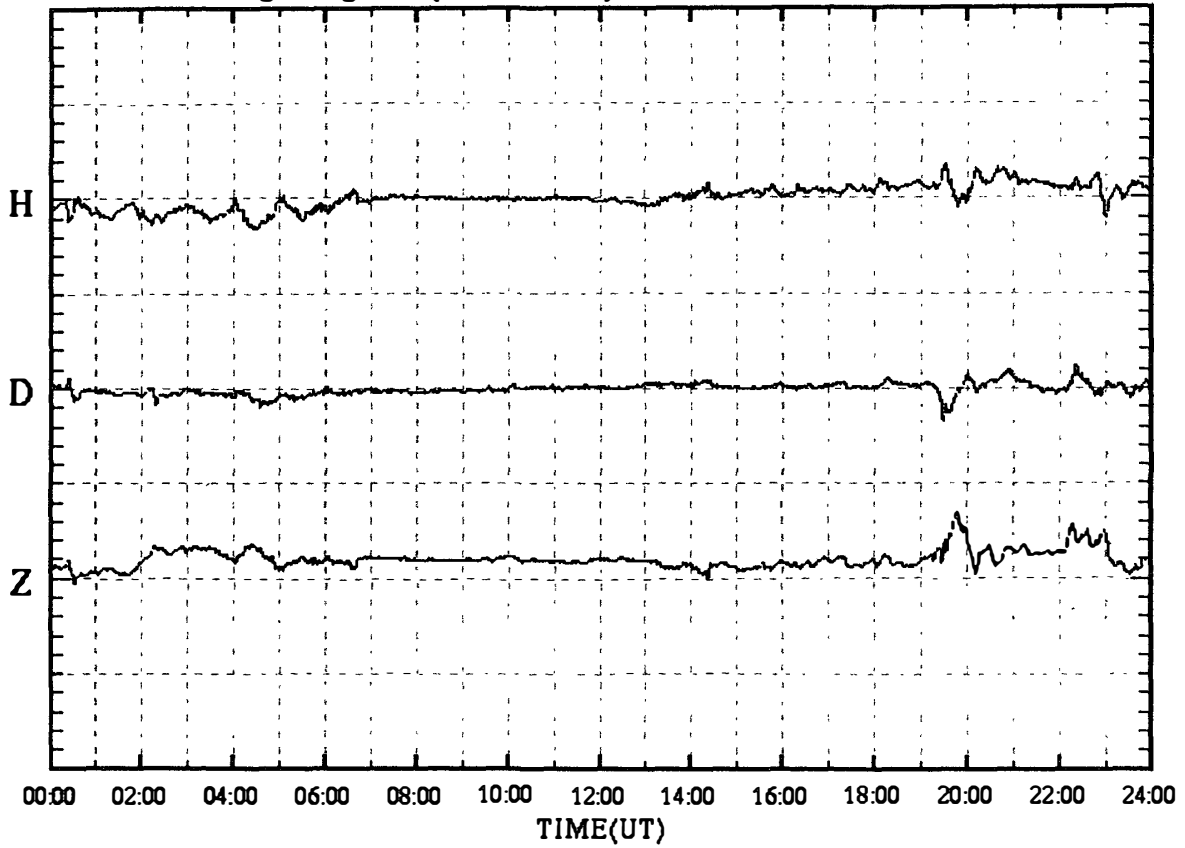

SYOWA magnetogram (100 nT/div)

16 Jun.2000 (DAY:168)

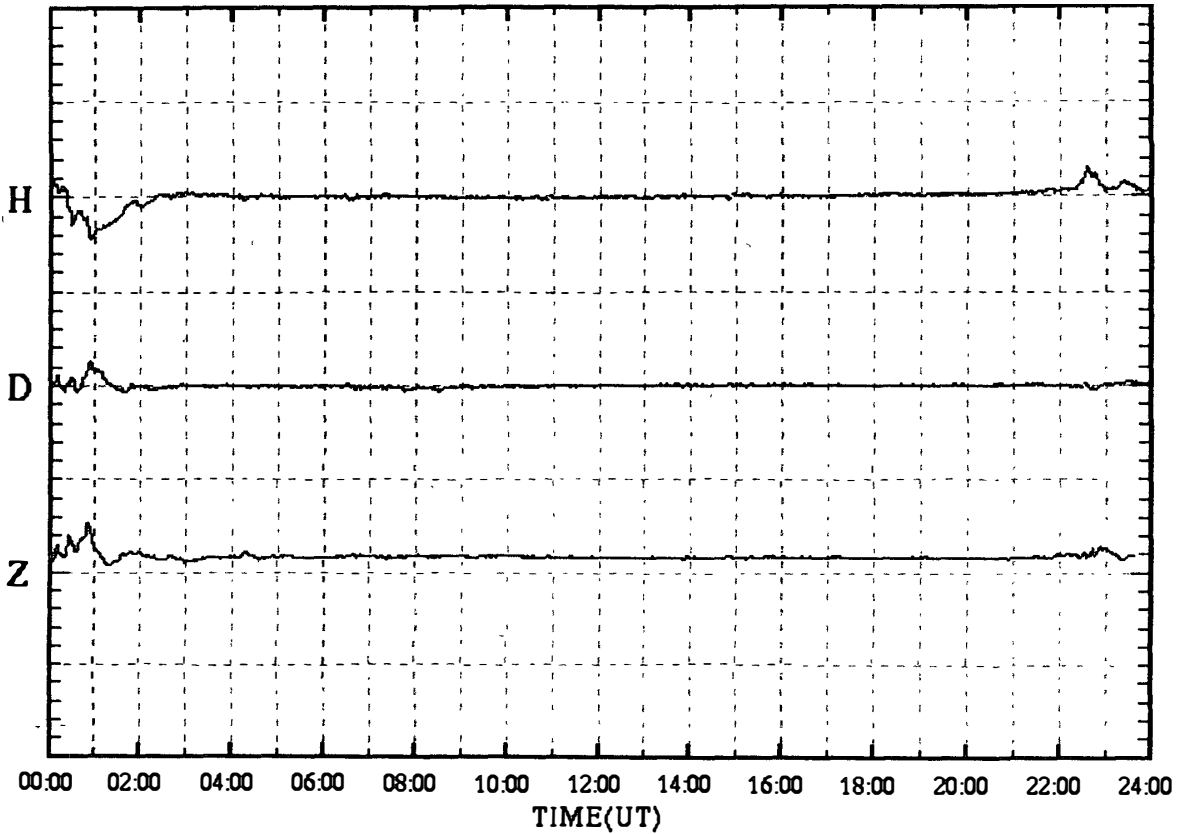

SYOWA magnetogram (100 nT/div)

17 Jun.2000 (DAY:169)

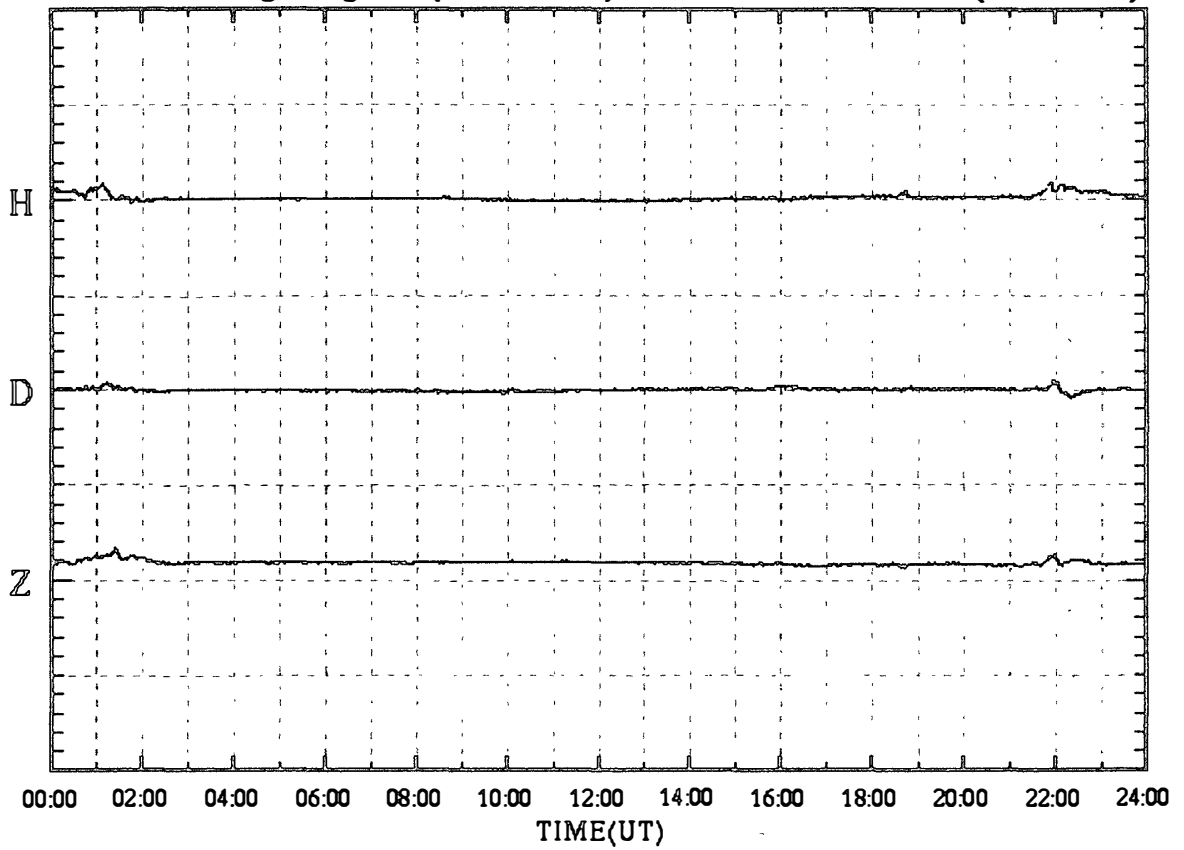

SYOWA magnetogram (100 nT/div)

18 Jun.2000 (DAY:170)

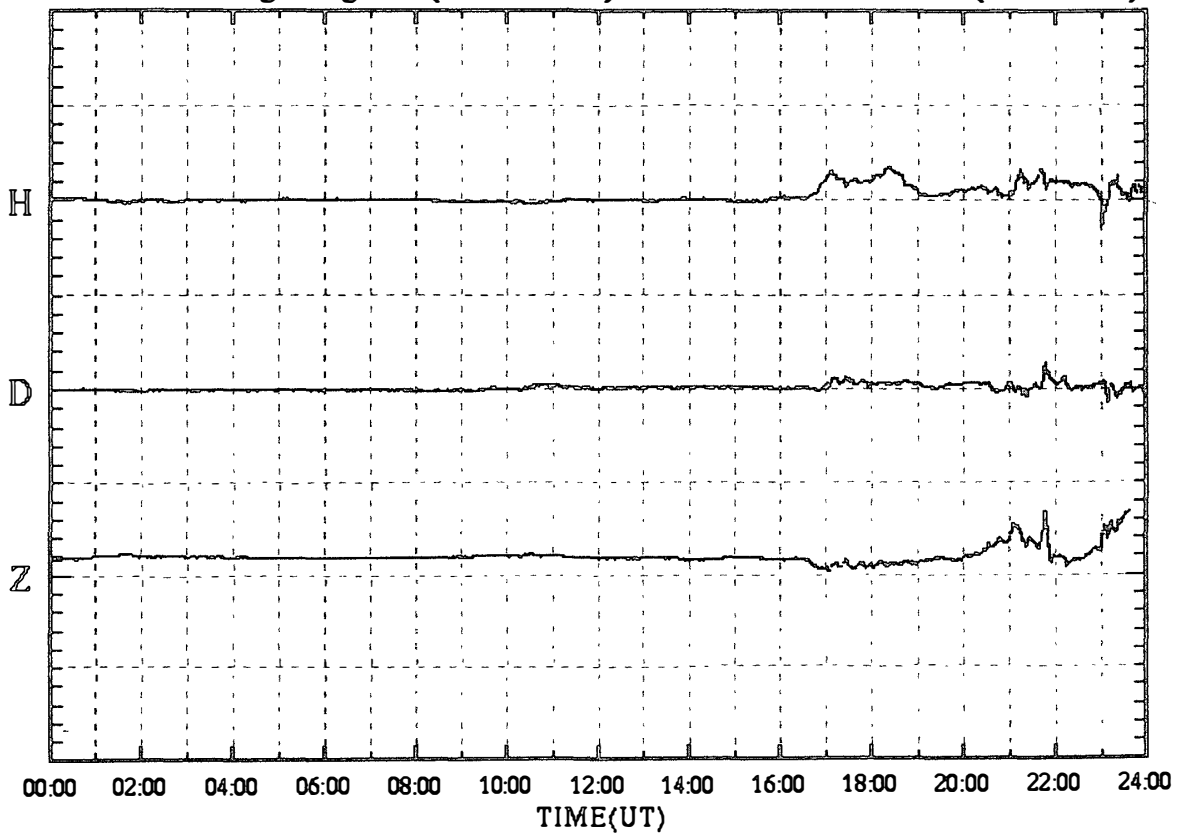

SYOWA magnetogram (100 nT/div)

19 Jun.2000 (DAY:171)

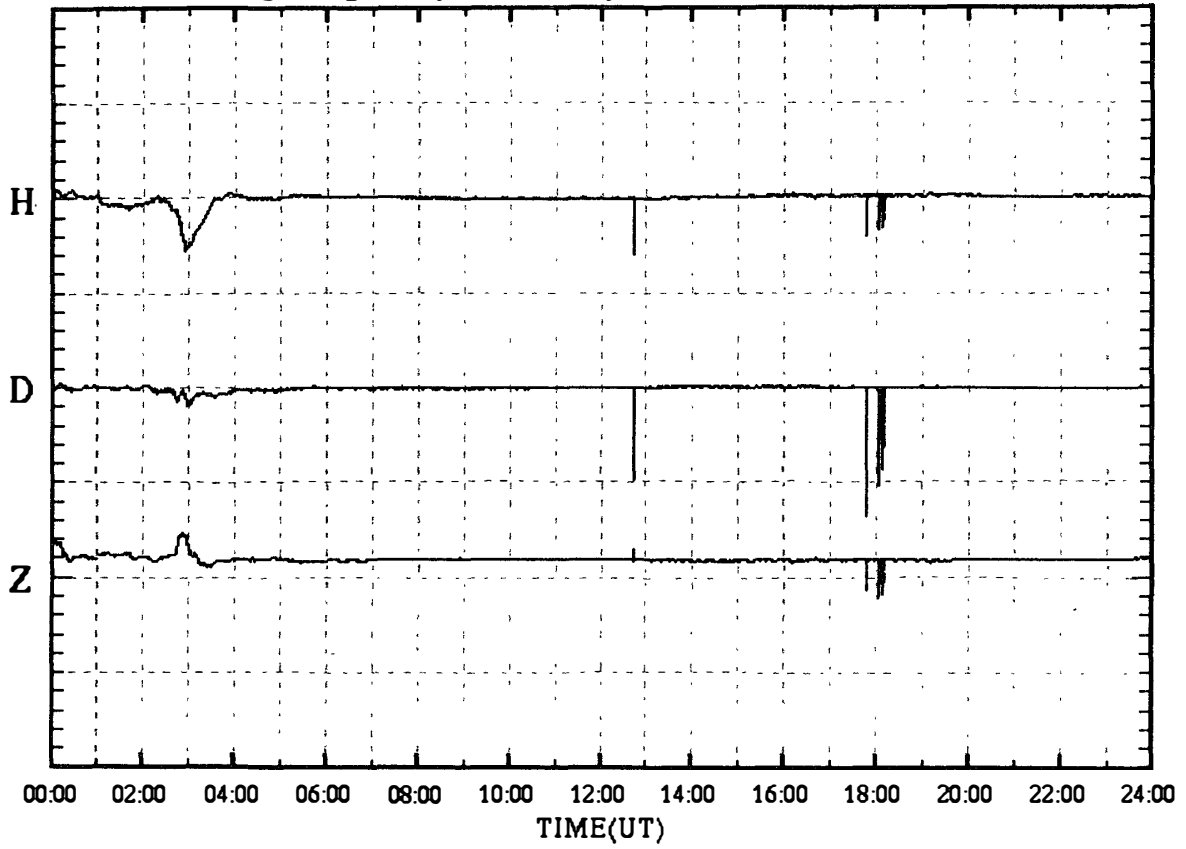

SYOWA magnetogram (100 nT/div)

20 Jun.2000 (DAY:172)

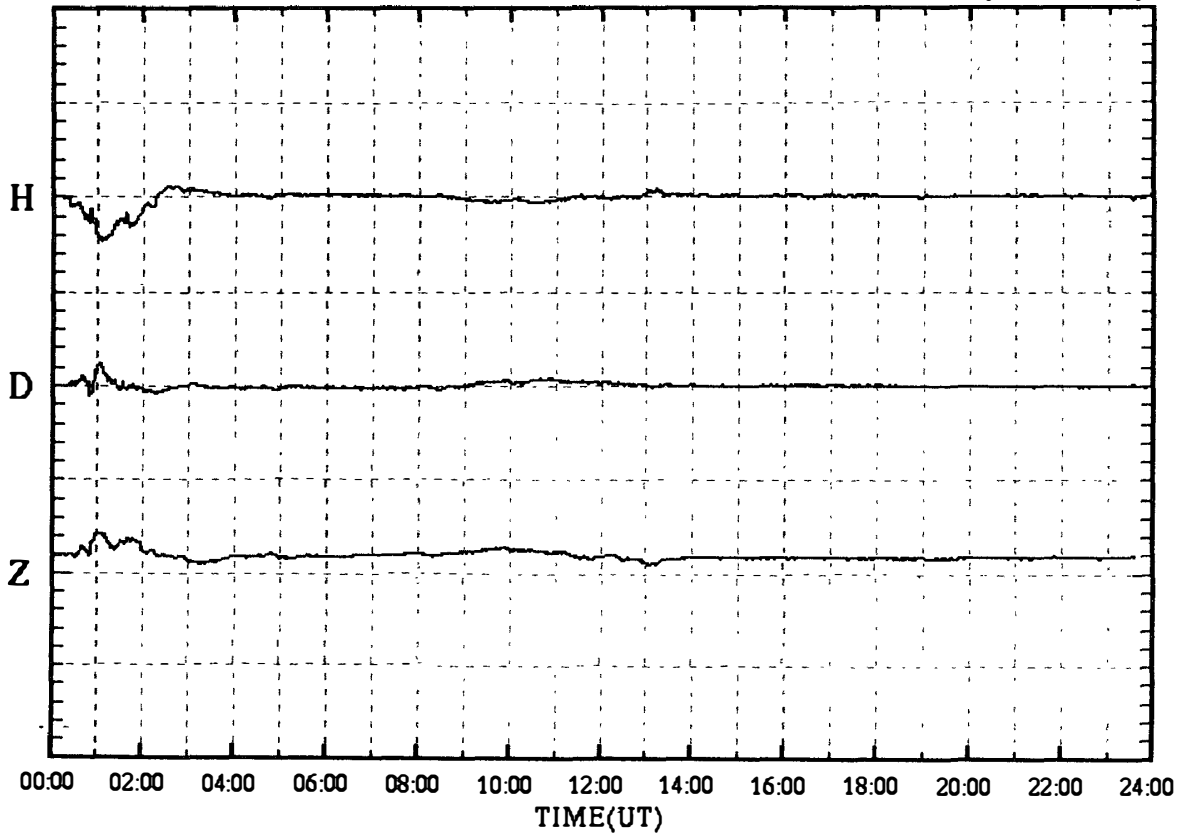

SYOWA magnetogram (100 nT/div)

21 Jun.2000 (DAY:173)

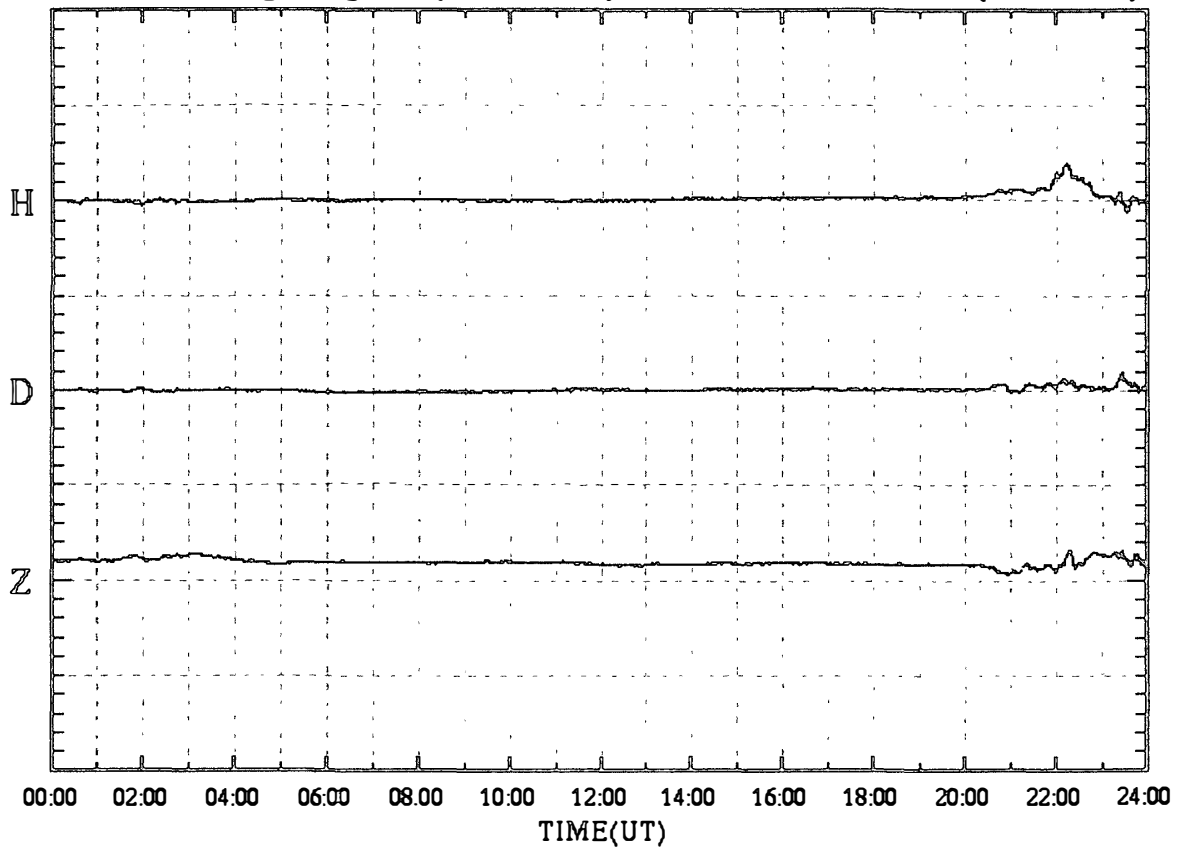

SYOWA magnetogram (100 nT/div)

22 Jun.2000 (DAY:174)

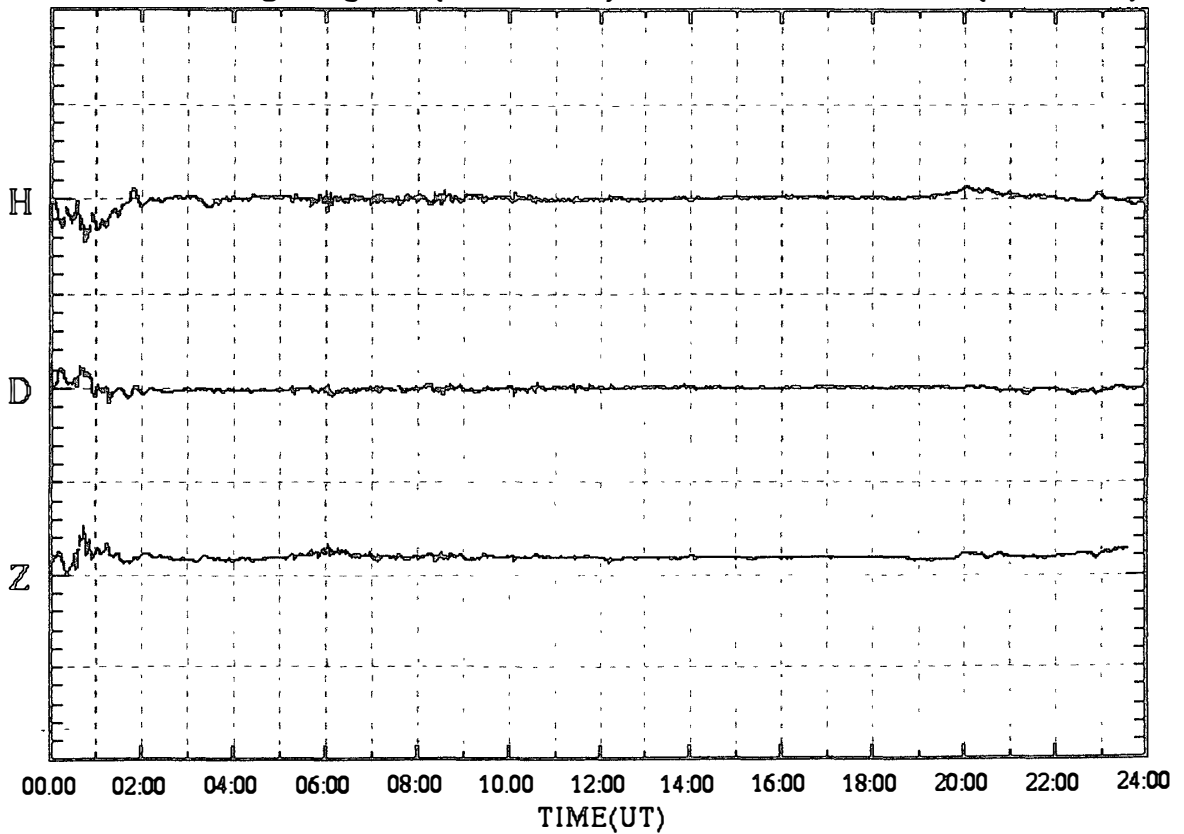

SYOWA magnetogram (100 nT/div)

23 Jun.2000 (DAY:175)

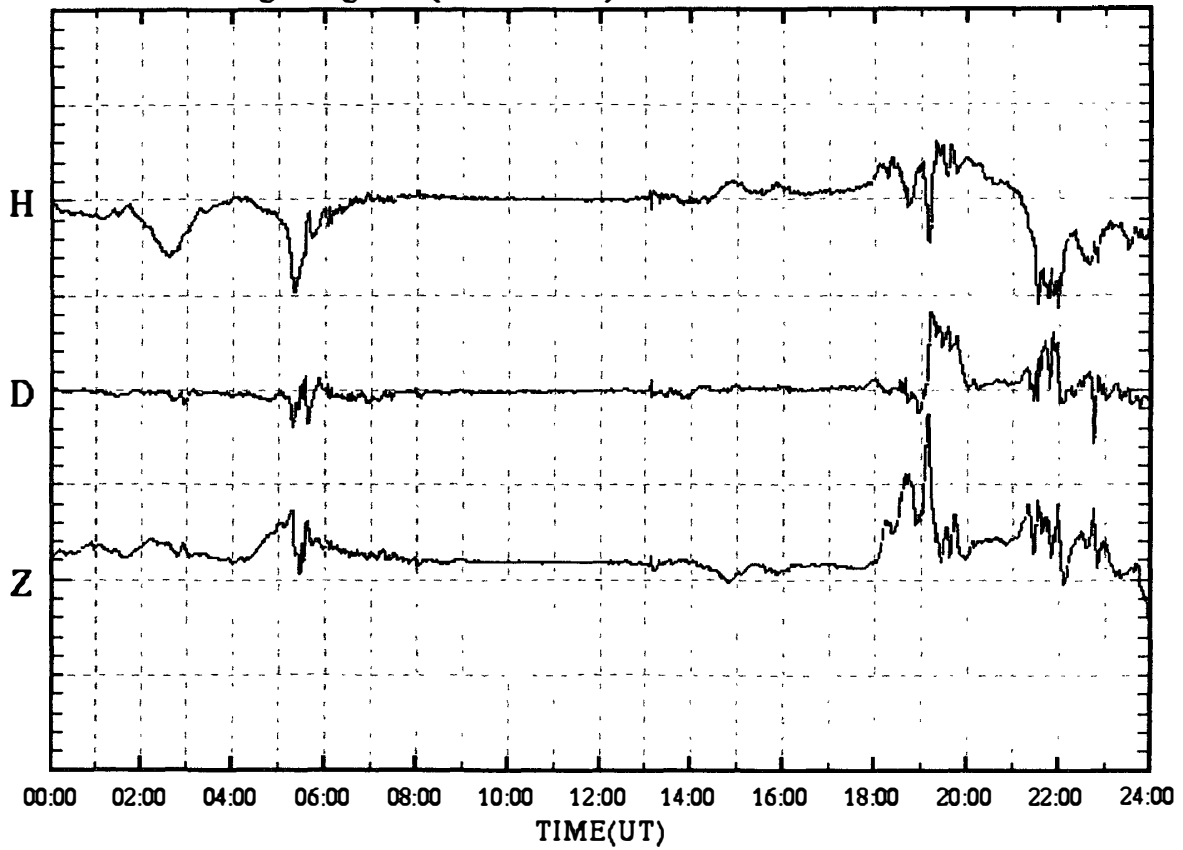

SYOWA magnetogram (100 nT/div)

24 Jun.2000 (DAY:176)

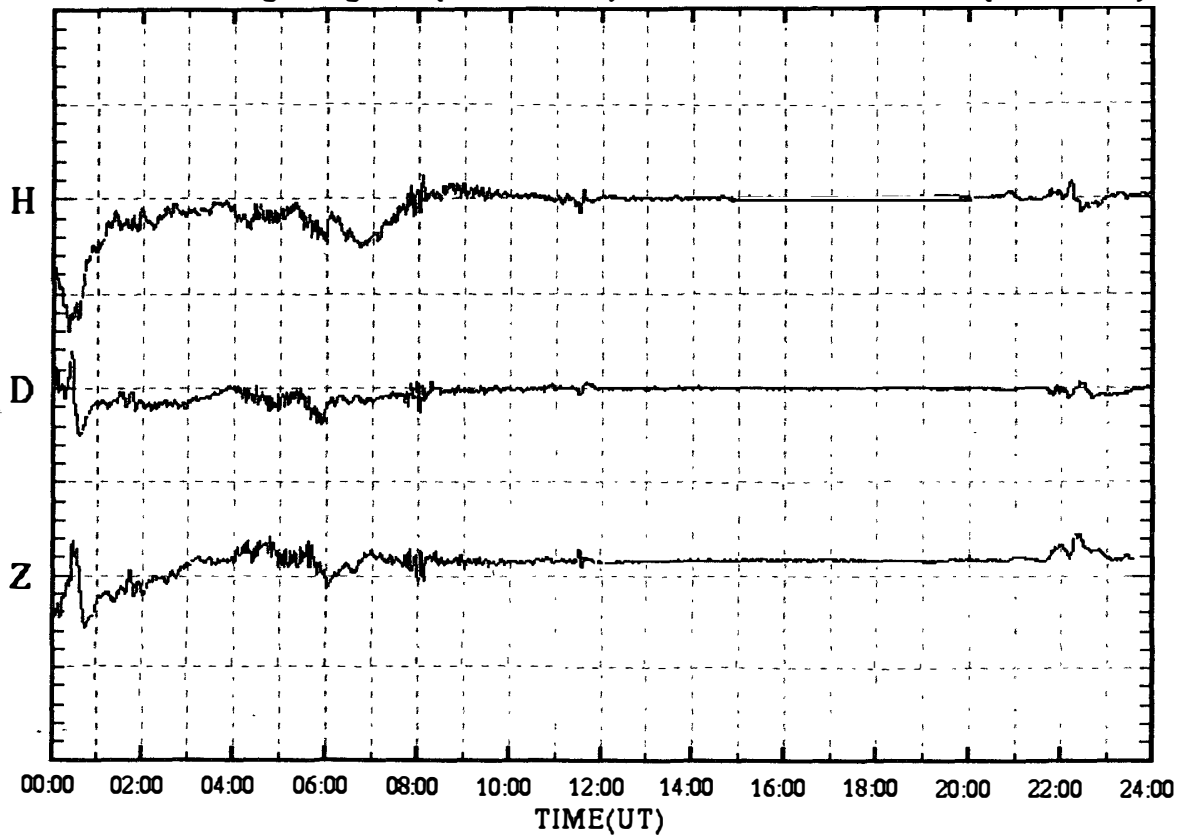

SYOWA magnetogram (100 nT/div)

25 Jun.2000 (DAY:177)

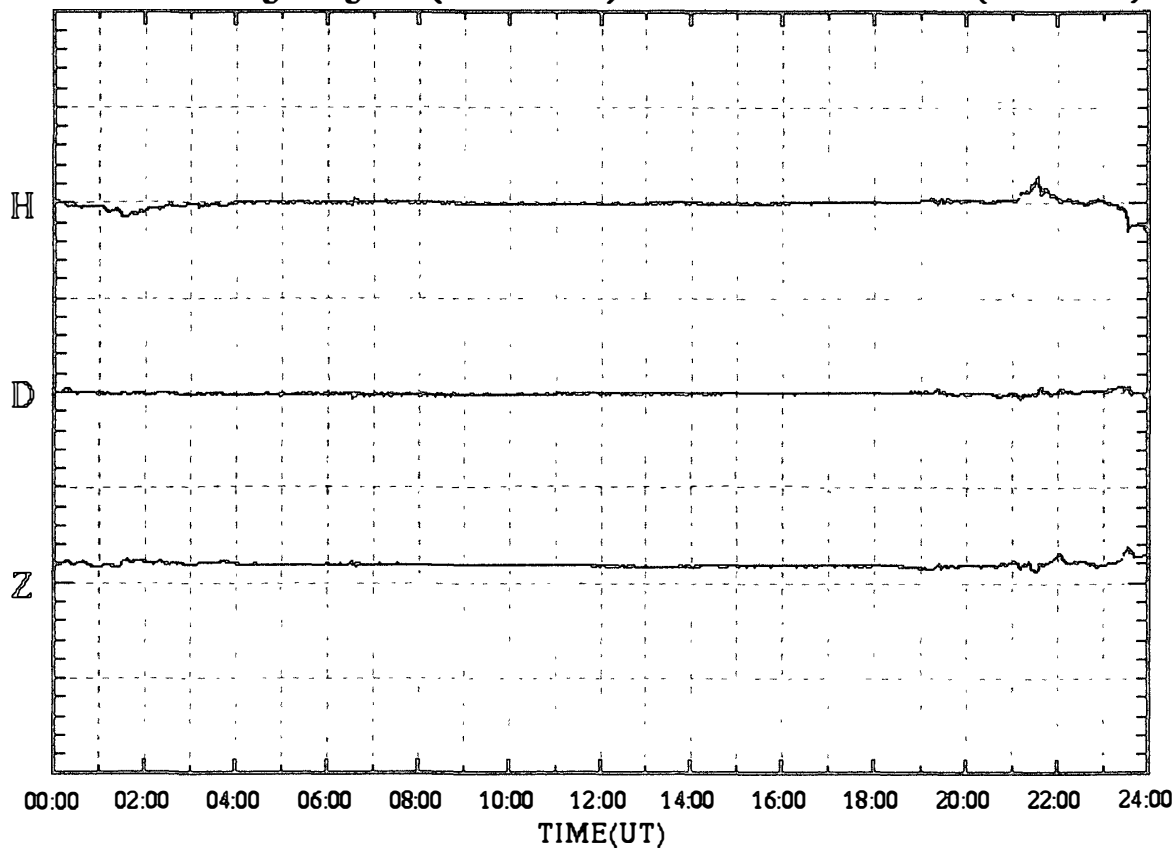

SYOWA magnetogram (100 nT/div)

26 Jun.2000 (DAY:178)

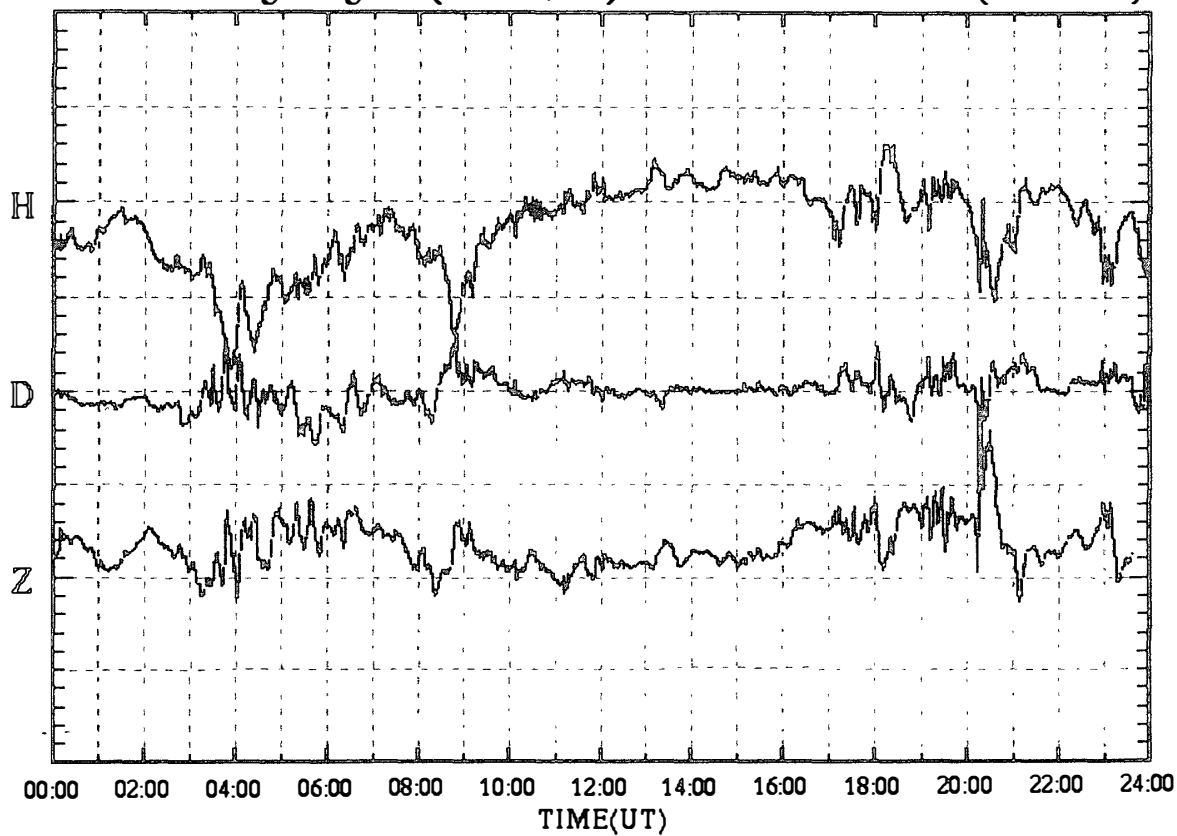

SYOWA magnetogram (100 nT/div)

27 Jun.2000 (DAY:179)

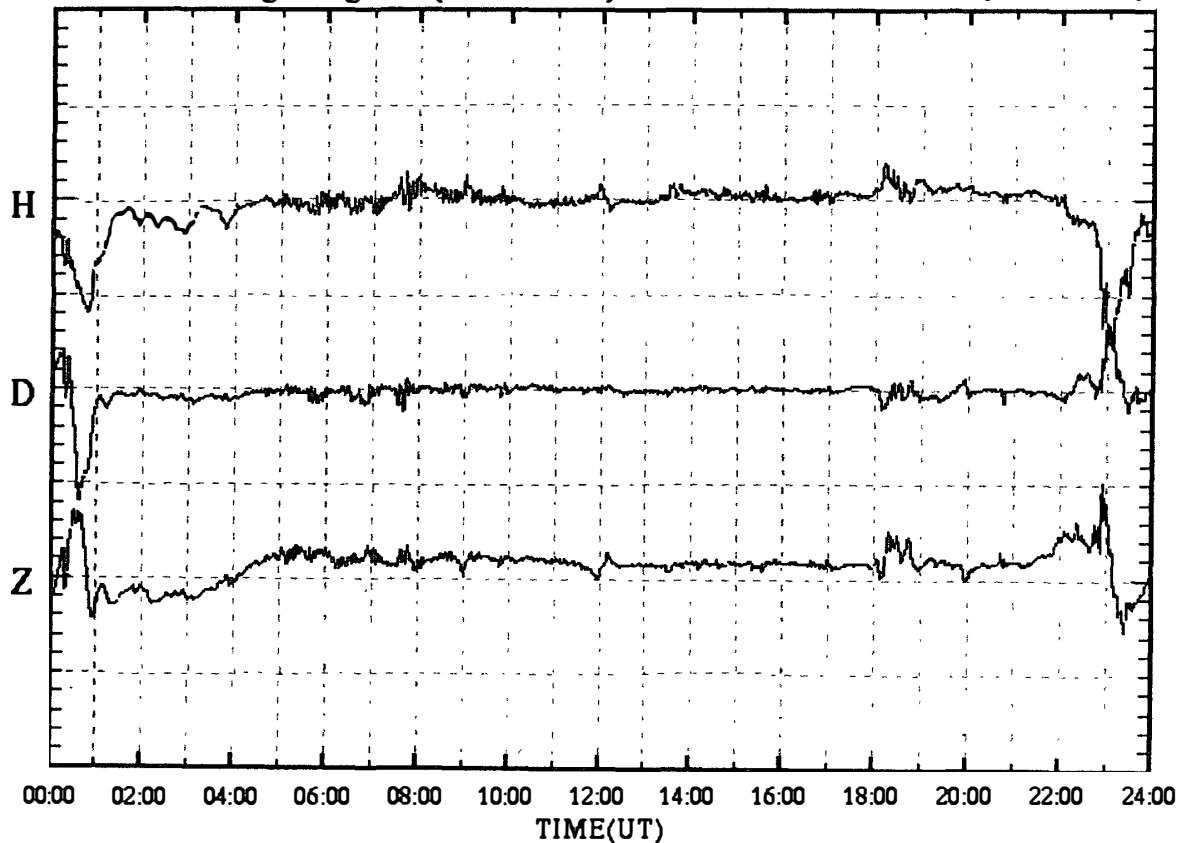

SYOWA magnetogram (100 nT/div)

28 Jun.2000 (DAY:180)

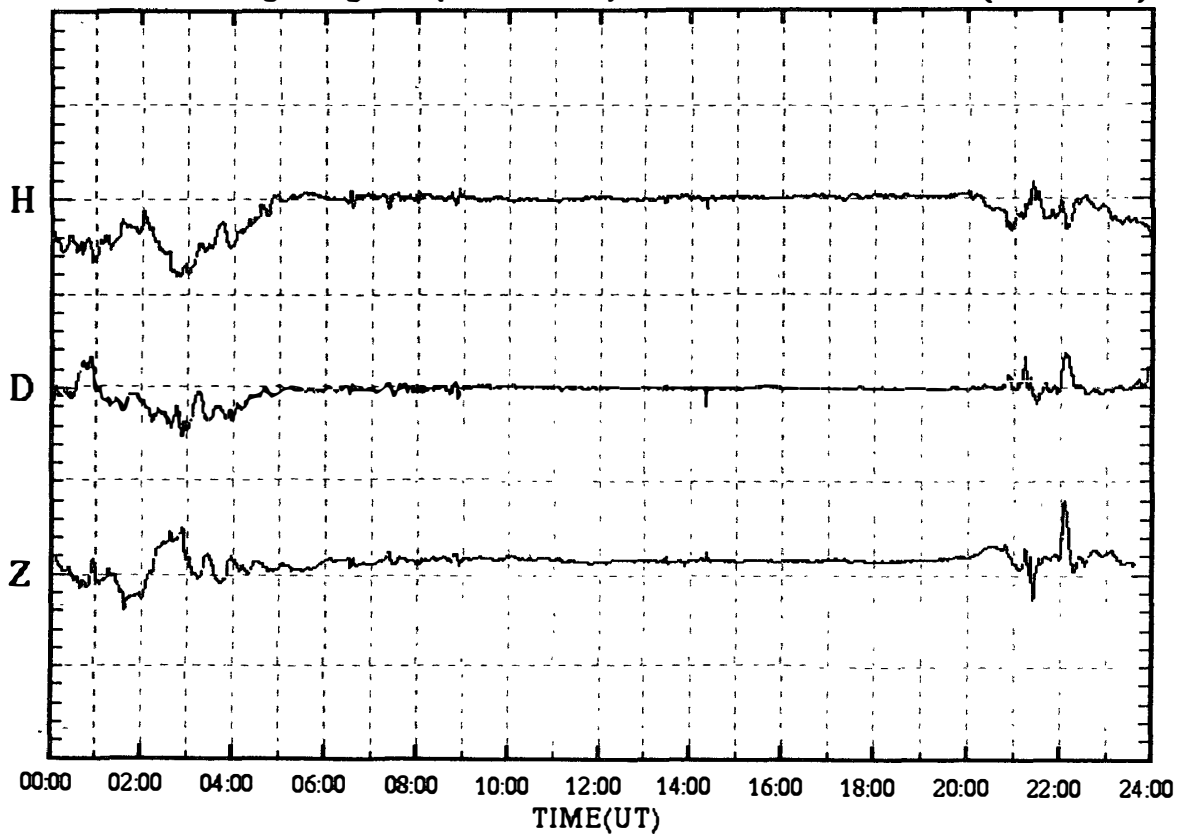

SYOWA magnetogram (100 nT/div)

29 Jun.2000 (DAY:181)

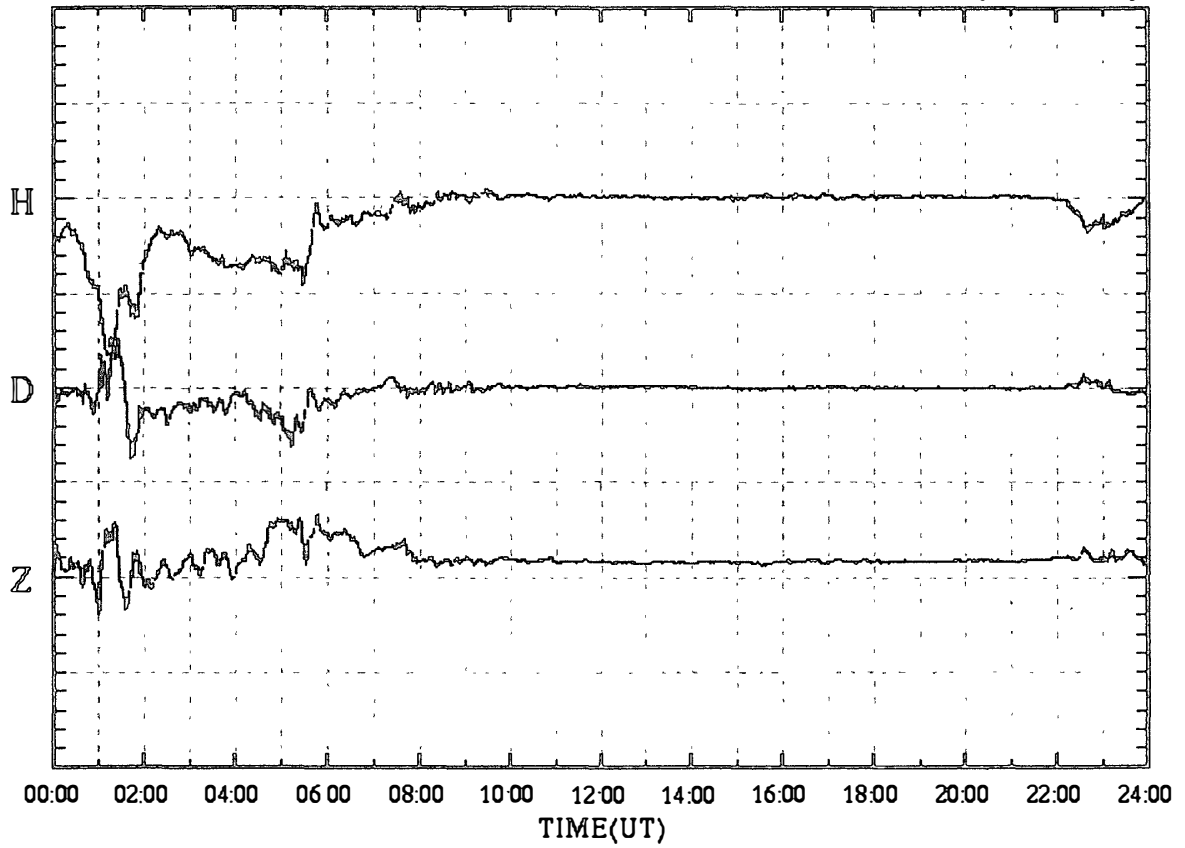

SYOWA magnetogram (100 nT/div)

30 Jun.2000 (DAY:182)

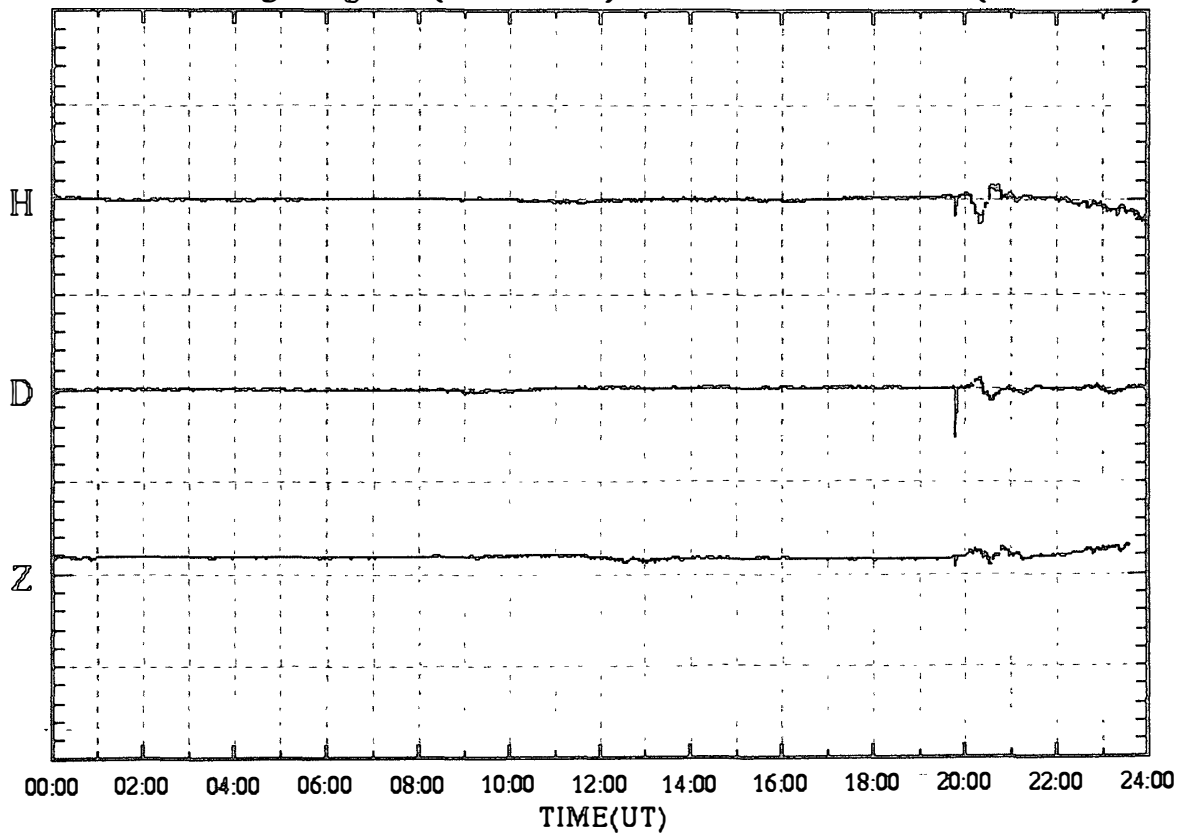

SYOWA magnetogram (100 nT/div)

01 Jul.2000 (DAY:183)

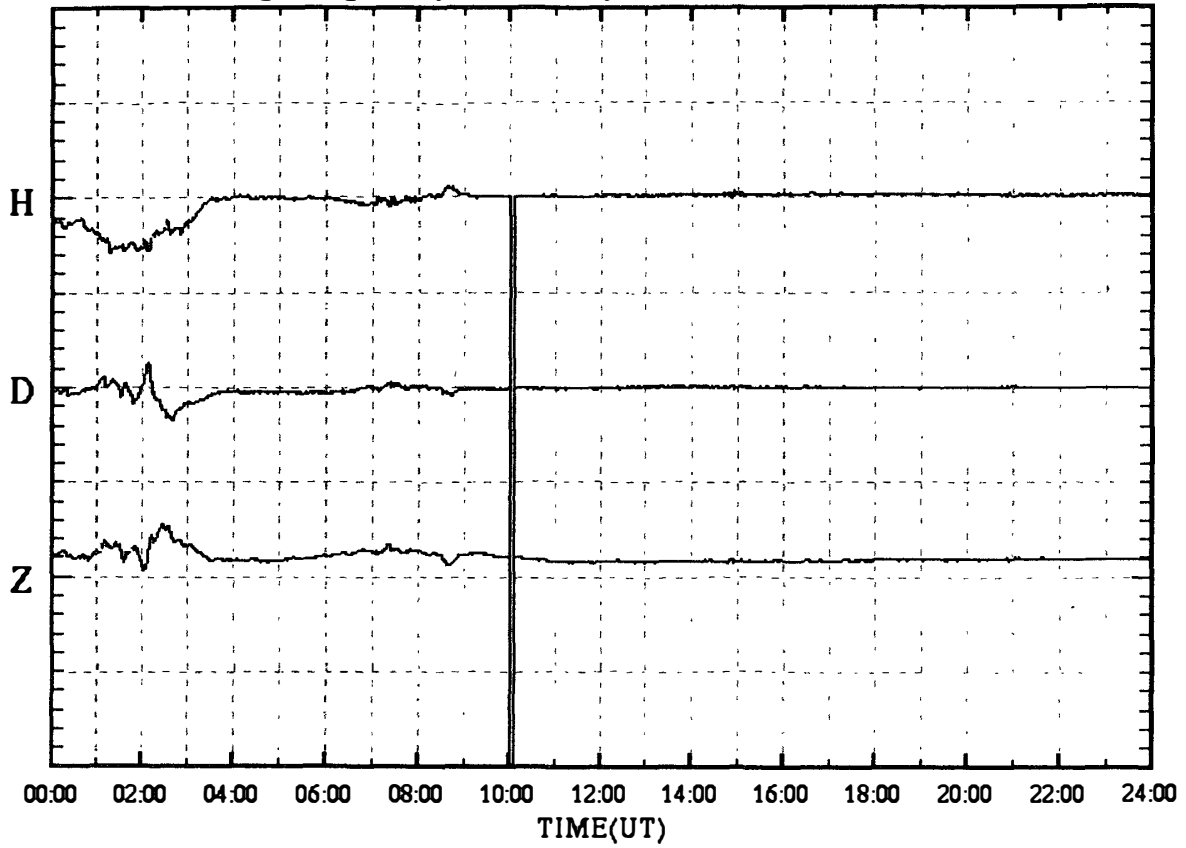

SYOWA magnetogram (100 nT/div)

02 Jul.2000 (DAY:184)

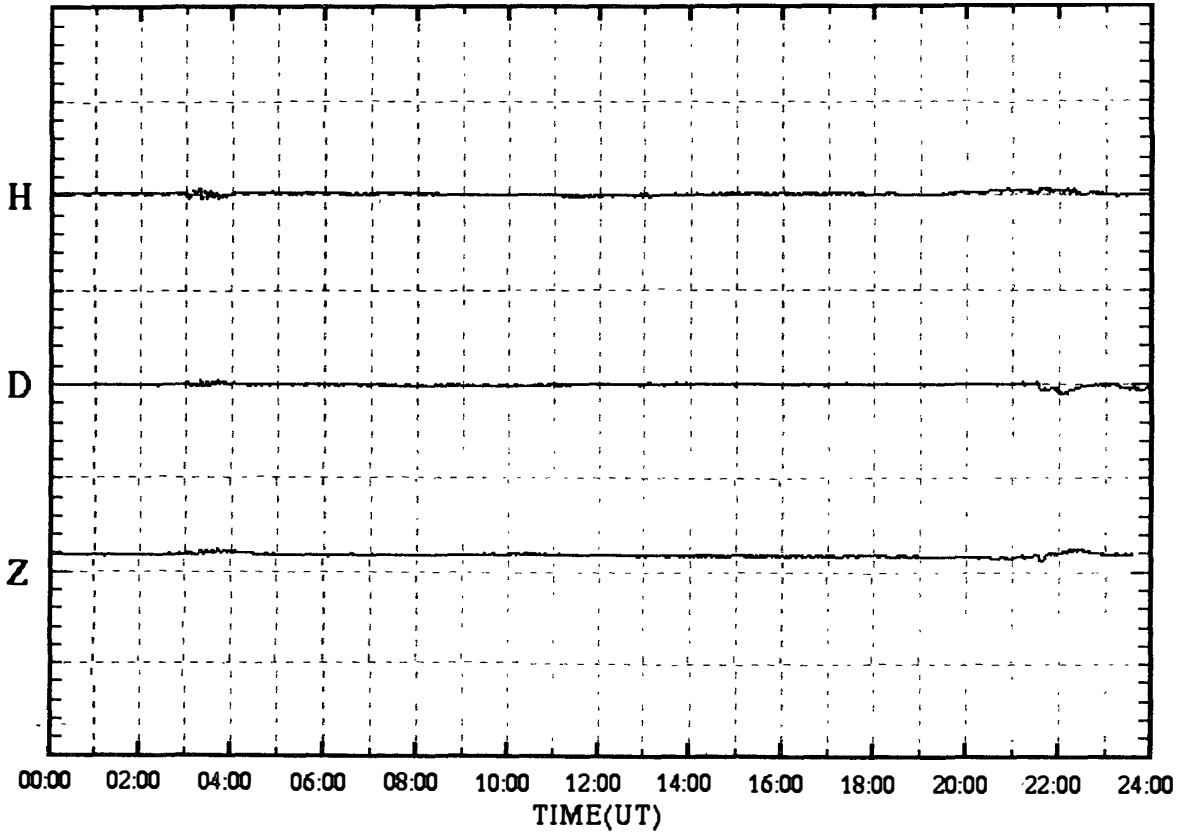

SYOWA magnetogram (100 nT/div)

03 Jul.2000 (DAY:185)

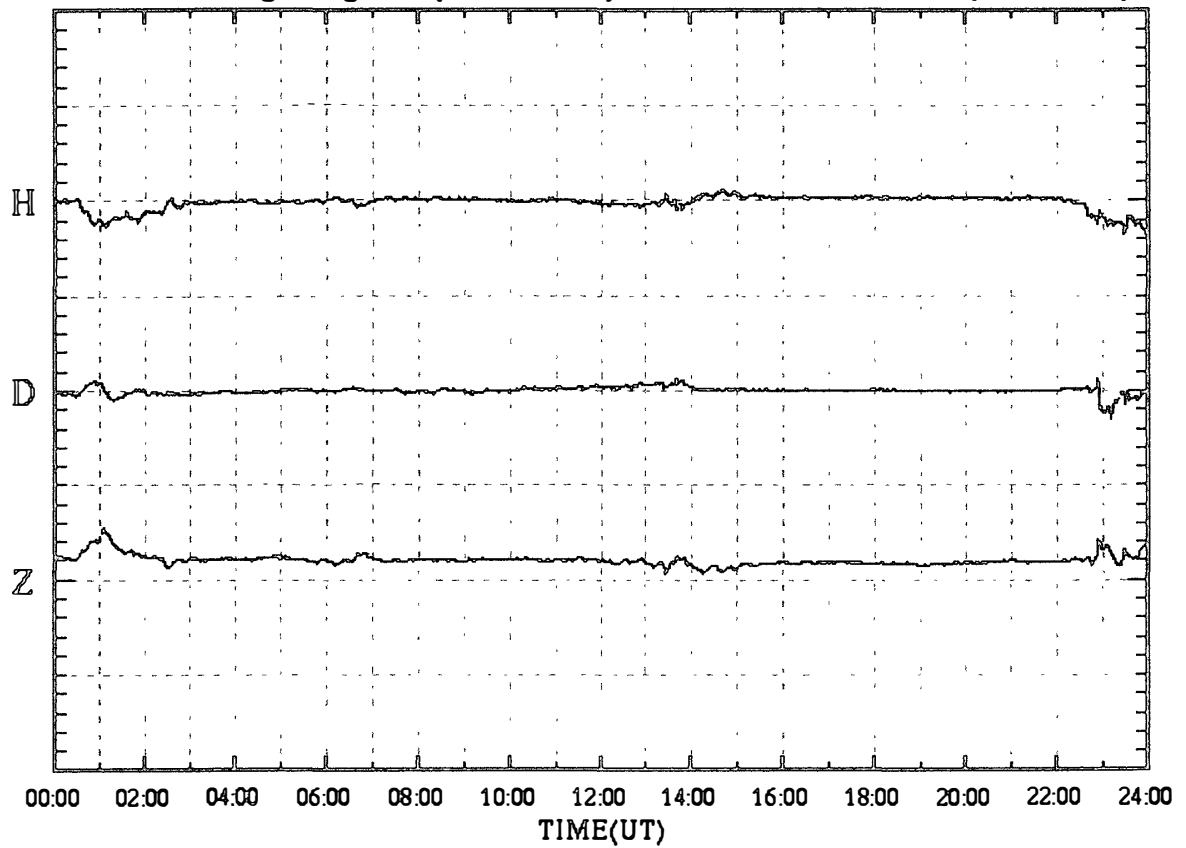

SYOWA magnetogram (100 nT/div)

04 Jul.2000 (DAY:186)

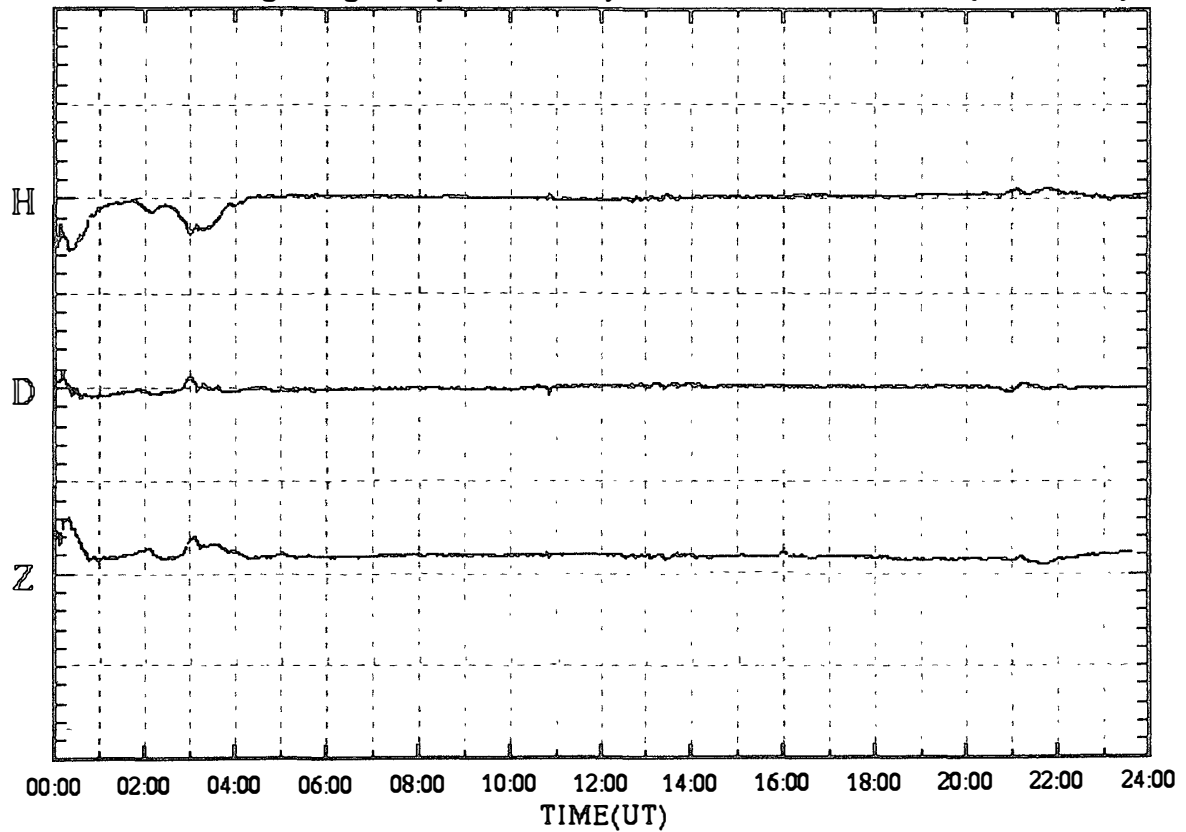

SYOWA magnetogram (100 nT/div)

05 Jul.2000 (DAY:187)

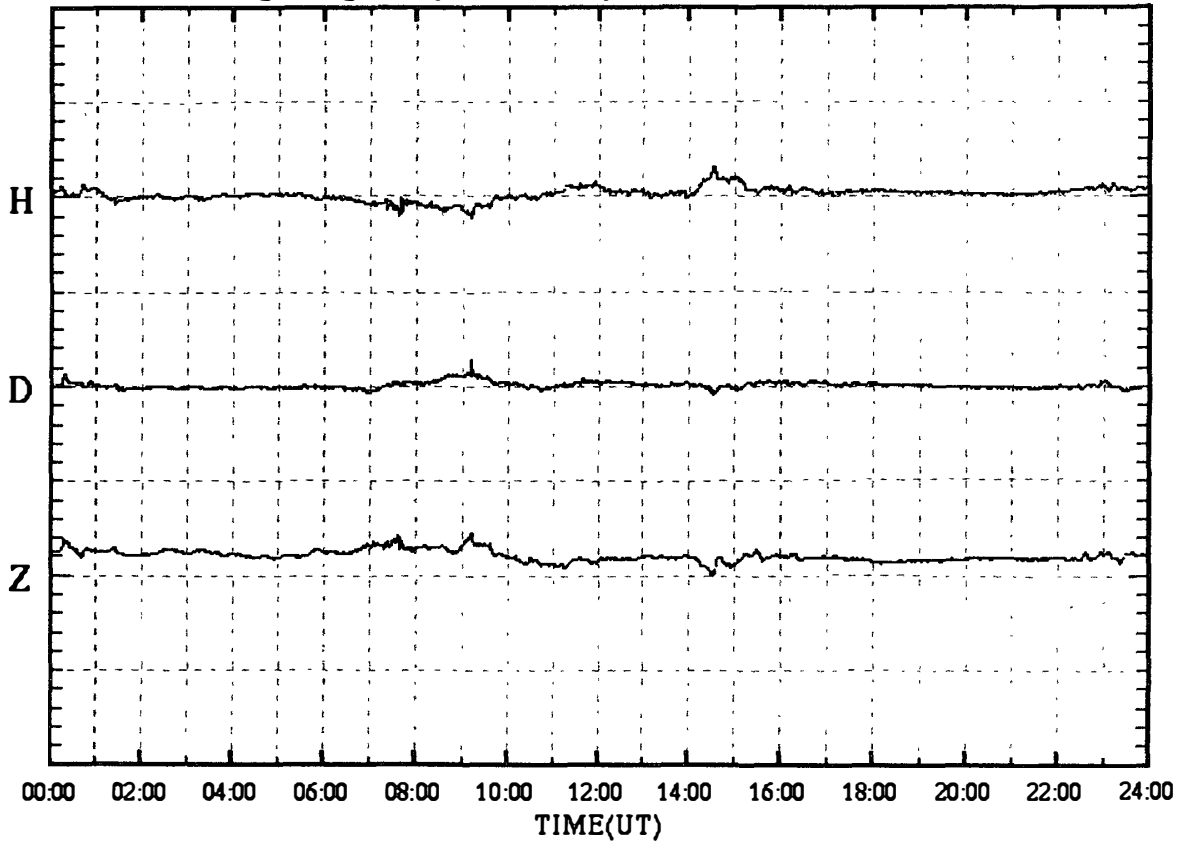

SYOWA magnetogram (100 nT/div)

06 Jul.2000 (DAY:188)

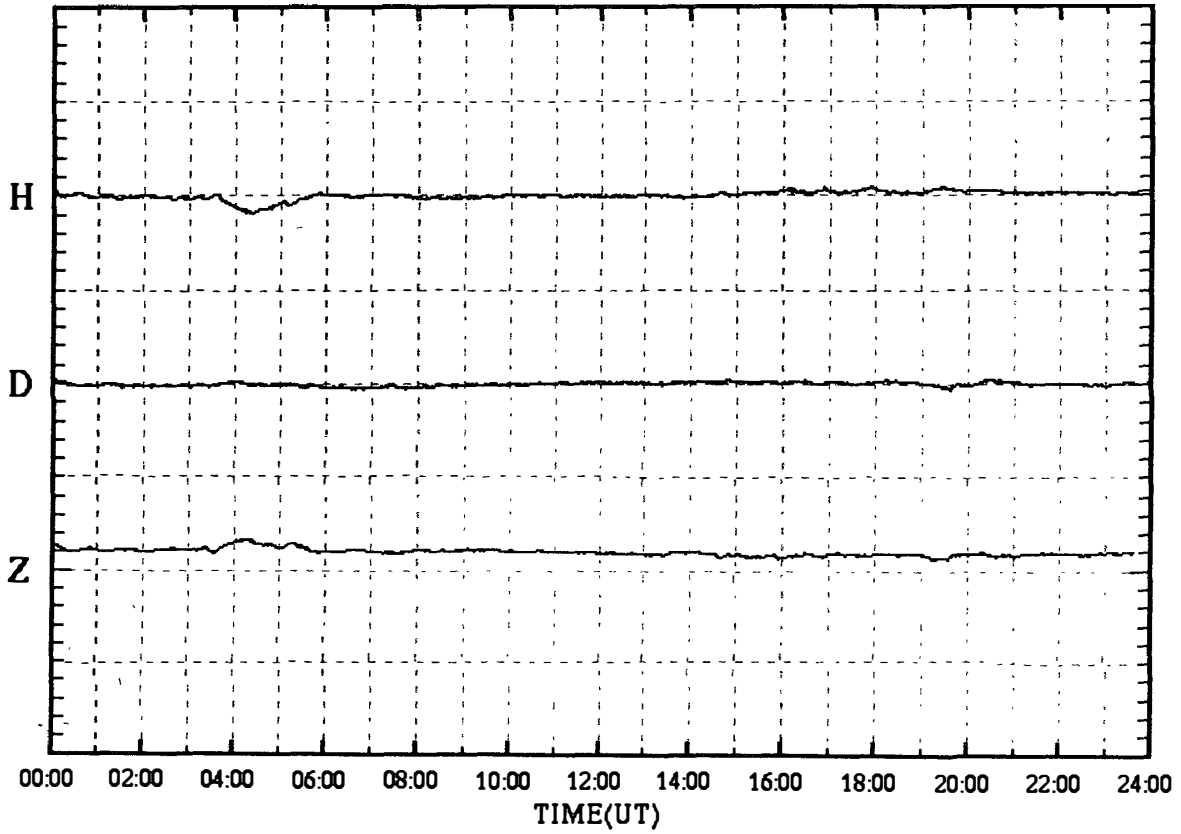

SYOWA magnetogram (100 nT/div)

07 Jul.2000 (DAY:189)

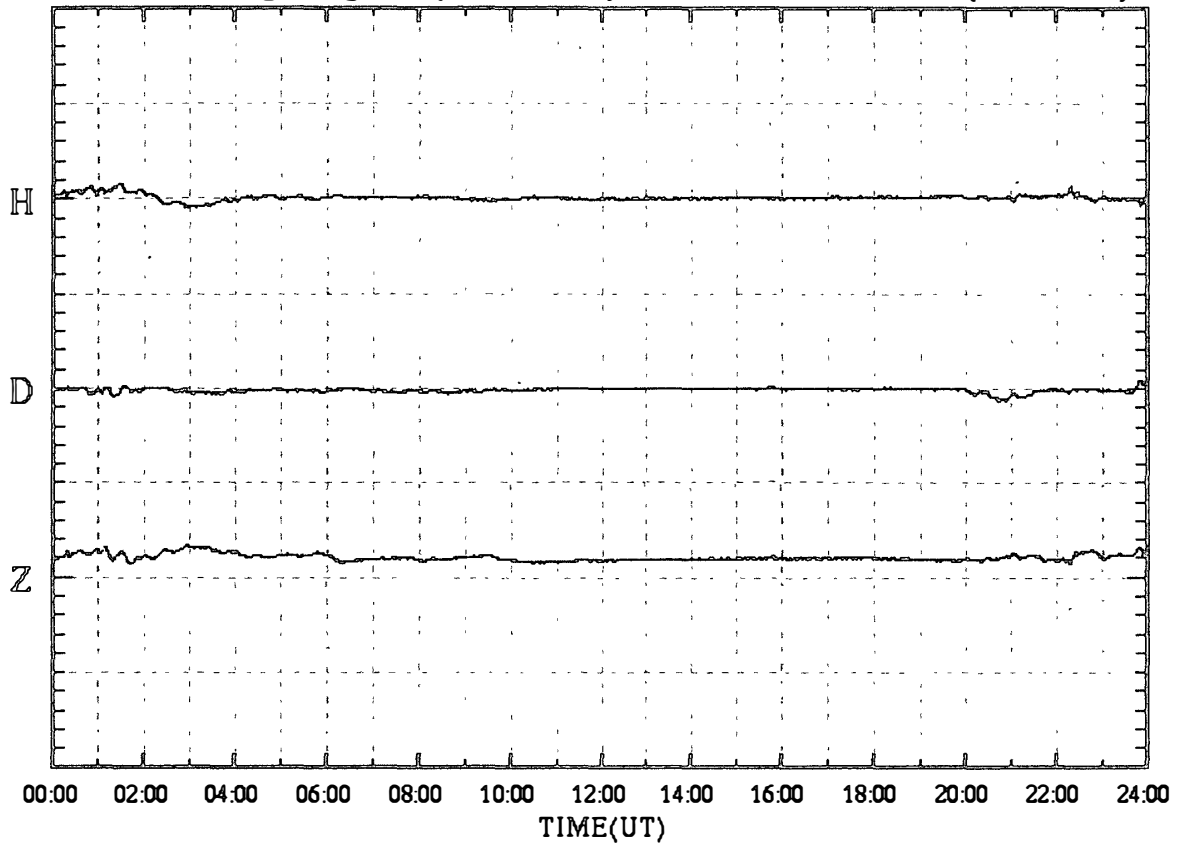

SYOWA magnetogram (100 nT/div)

08 Jul.2000 (DAY:190)

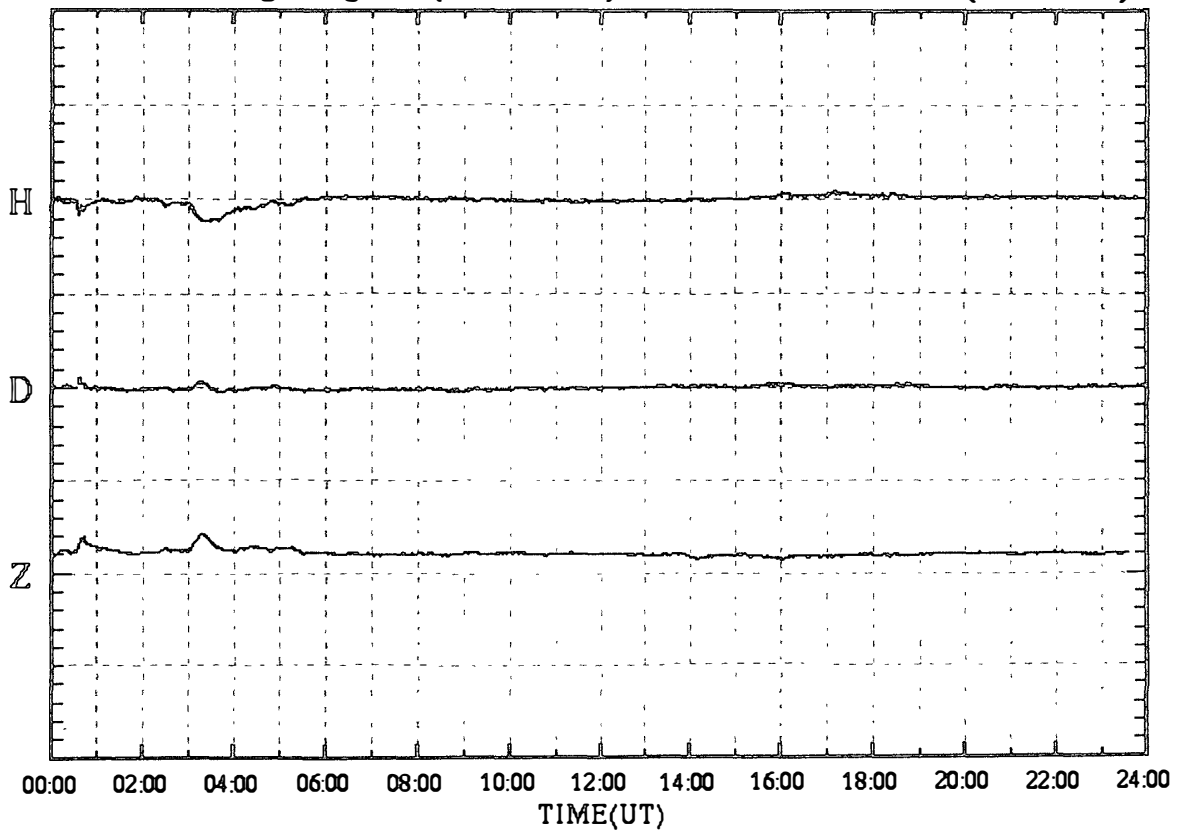

SYOWA magnetogram (100 nT/div)

09 Jul.2000 (DAY:191)

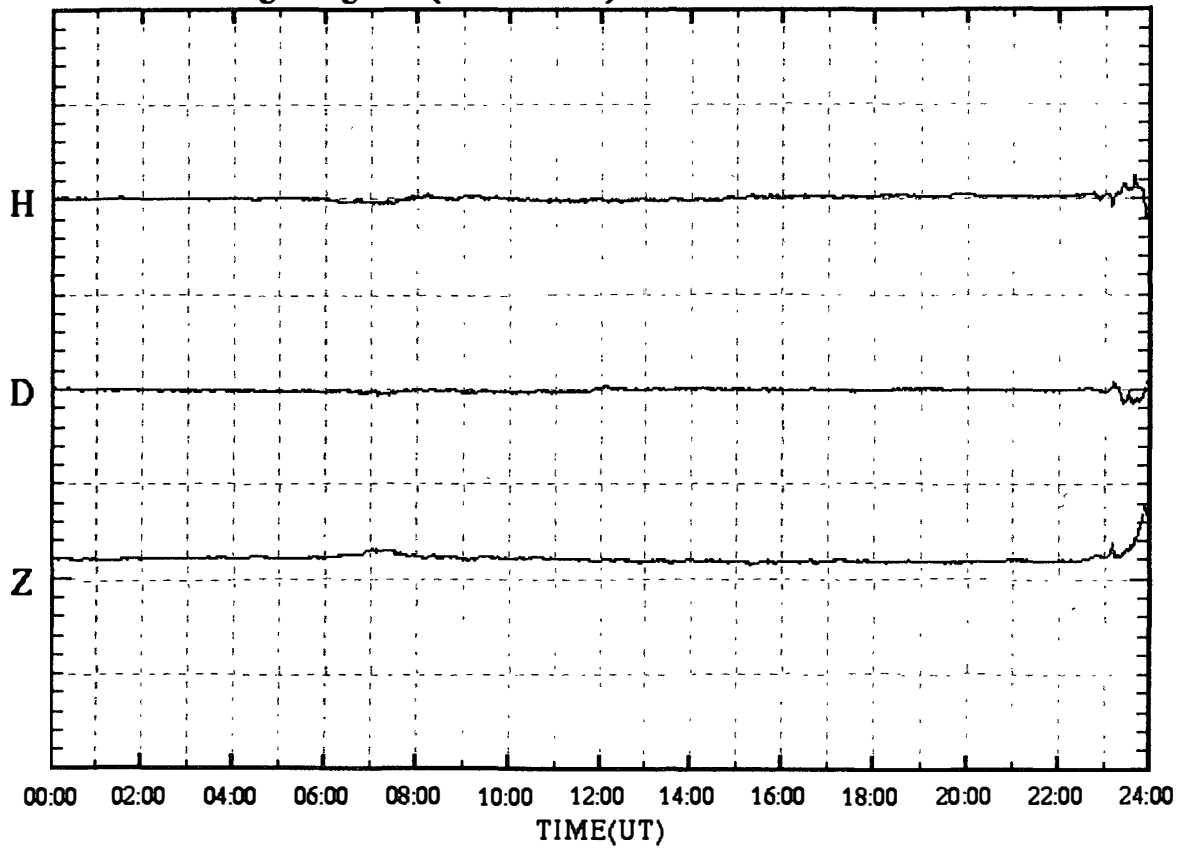

SYOWA magnetogram (100 nT/div)

10 Jul.2000 (DAY:192)

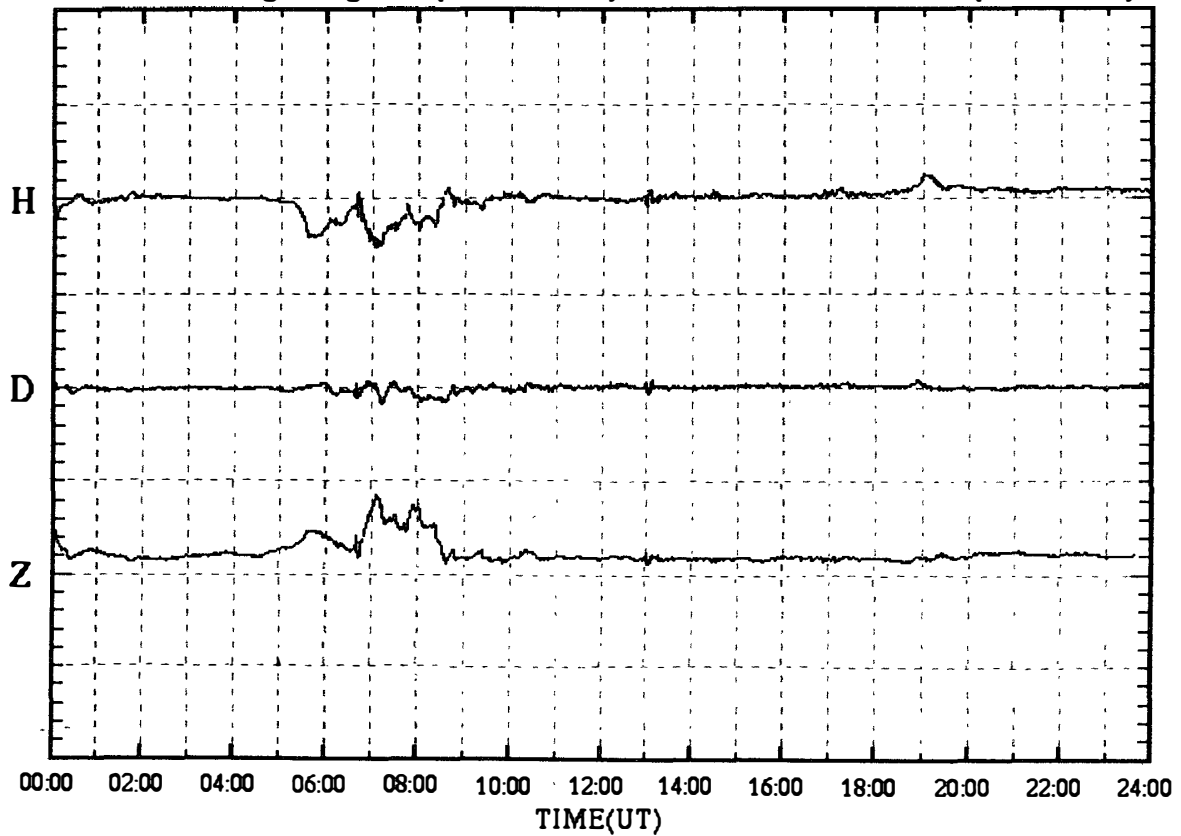

SYOWA magnetogram (100 nT/div)

11 Jul.2000 (DAY:193)

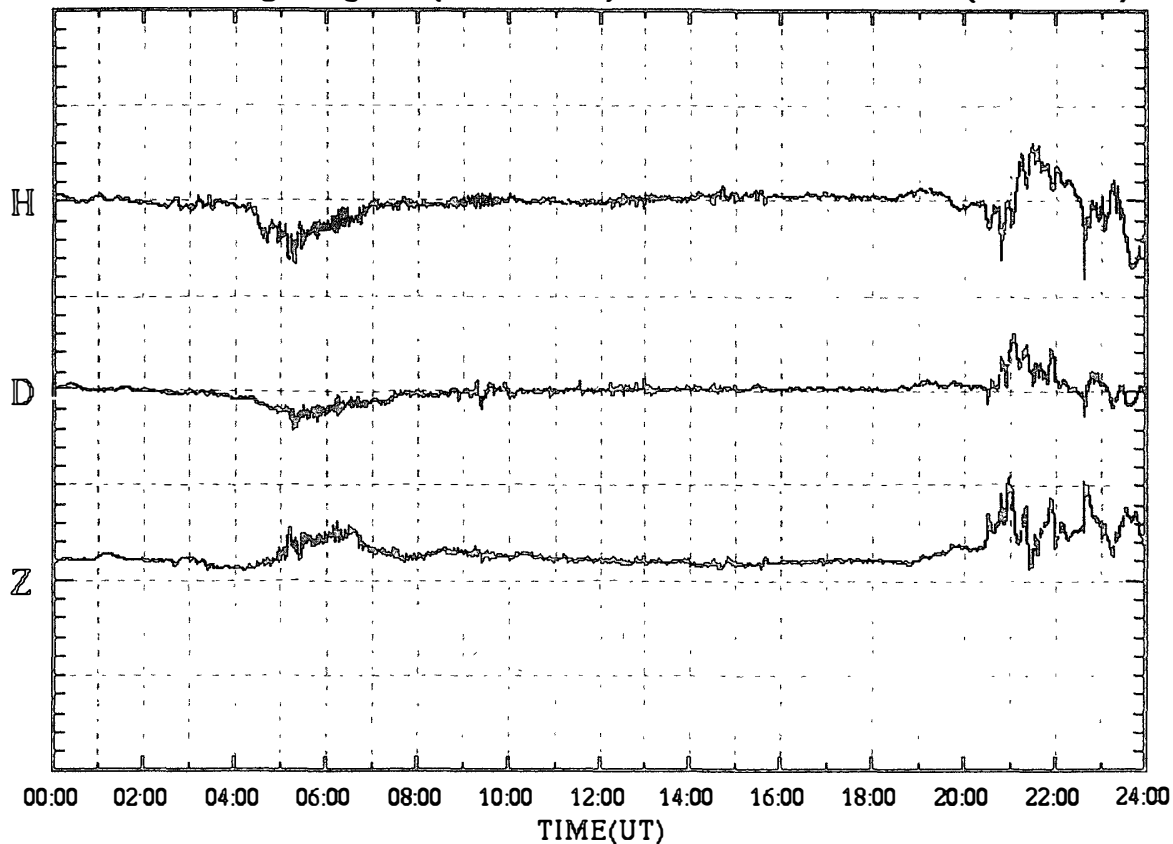

SYOWA magnetogram (100 nT/div)

12 Jul.2000 (DAY:194)

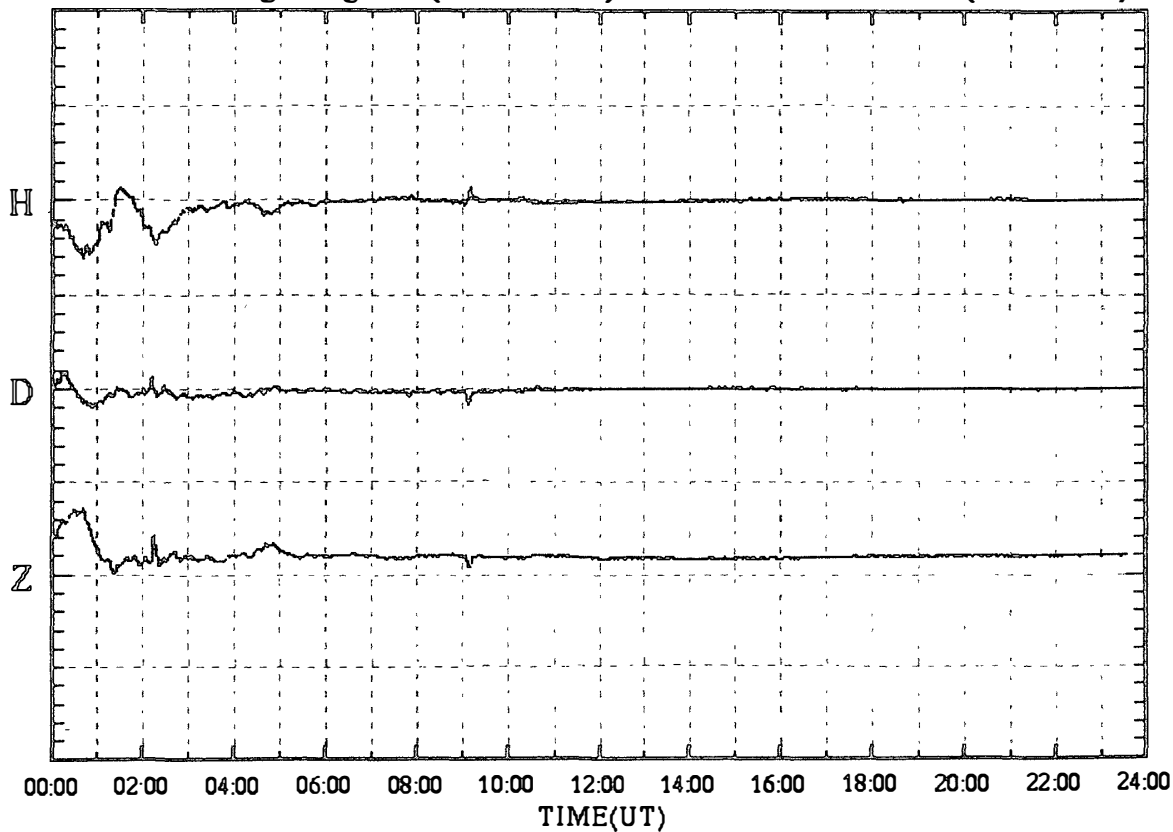

SYOWA magnetogram (100 nT/div)

13 Jul.2000 (DAY:195)

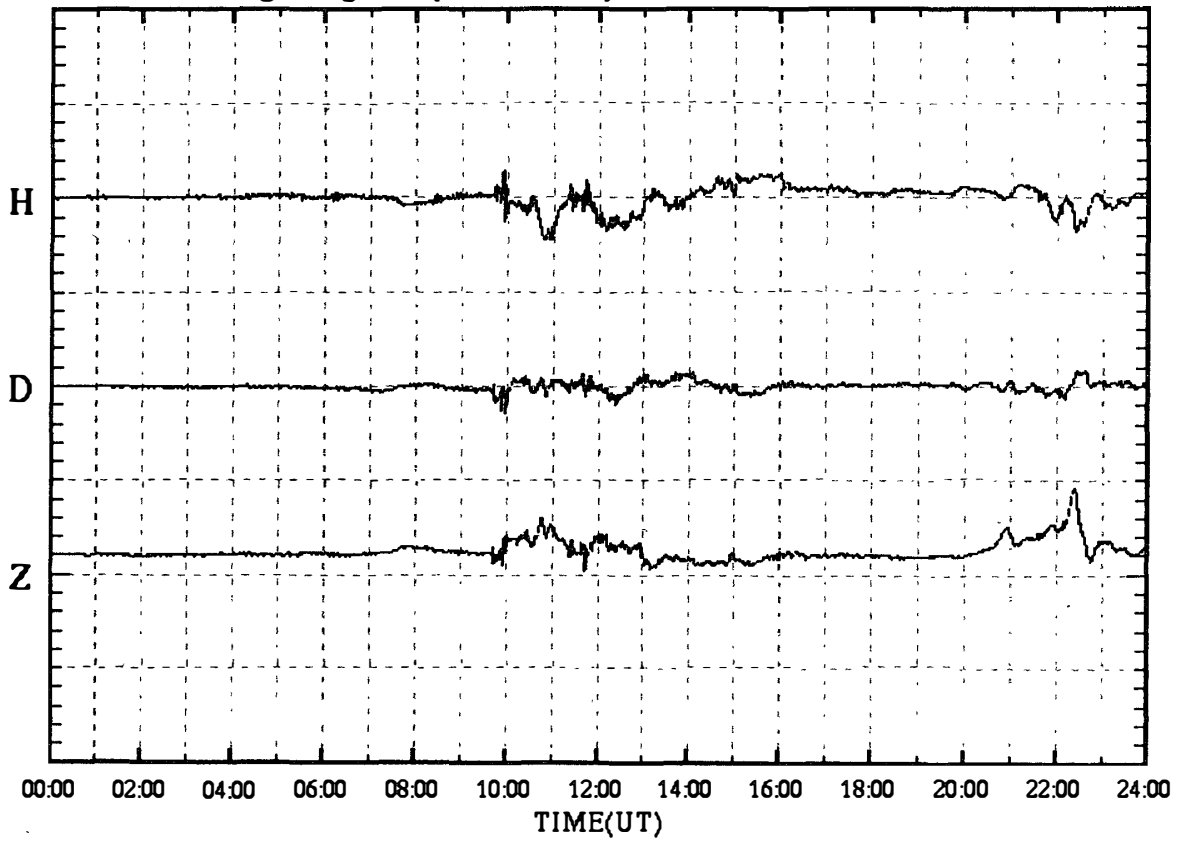

SYOWA magnetogram (100 nT/div)

14 Jul.2000 (DAY:196)

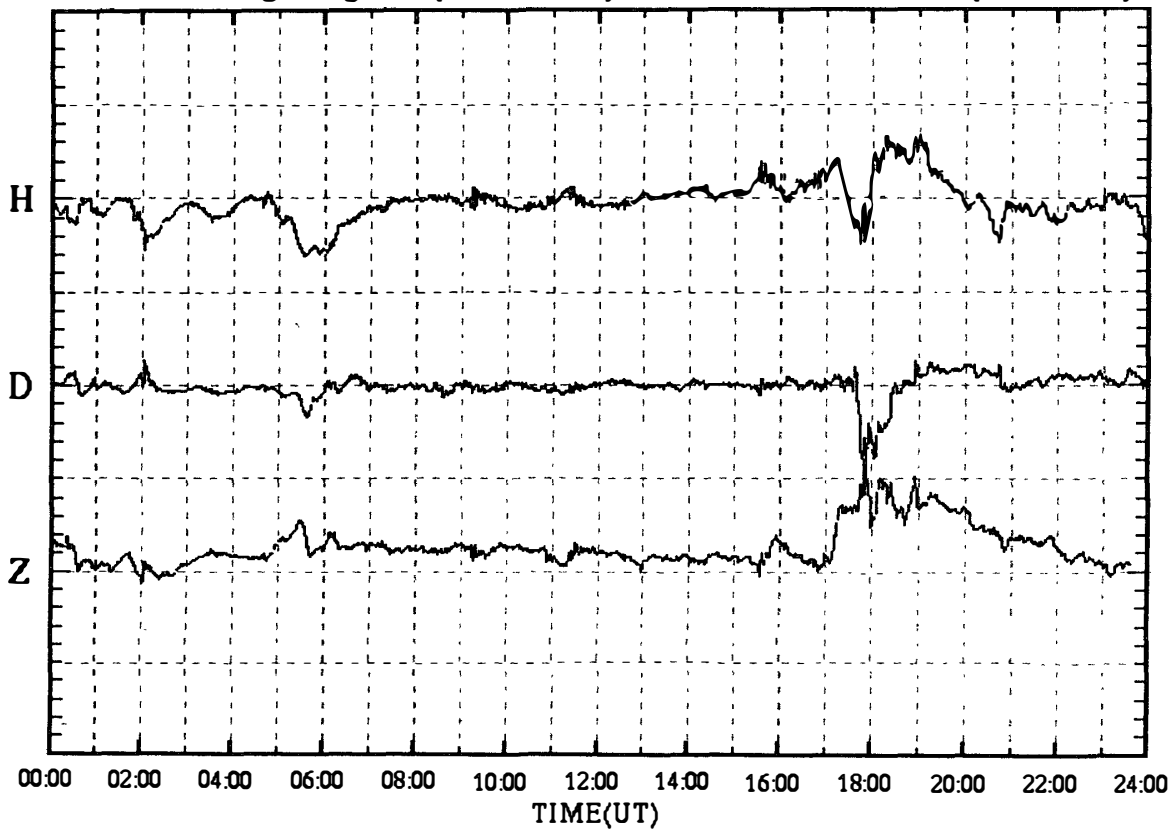

SYOWA magnetogram (100 nT/div)

15 Jul.2000 (DAY:197)

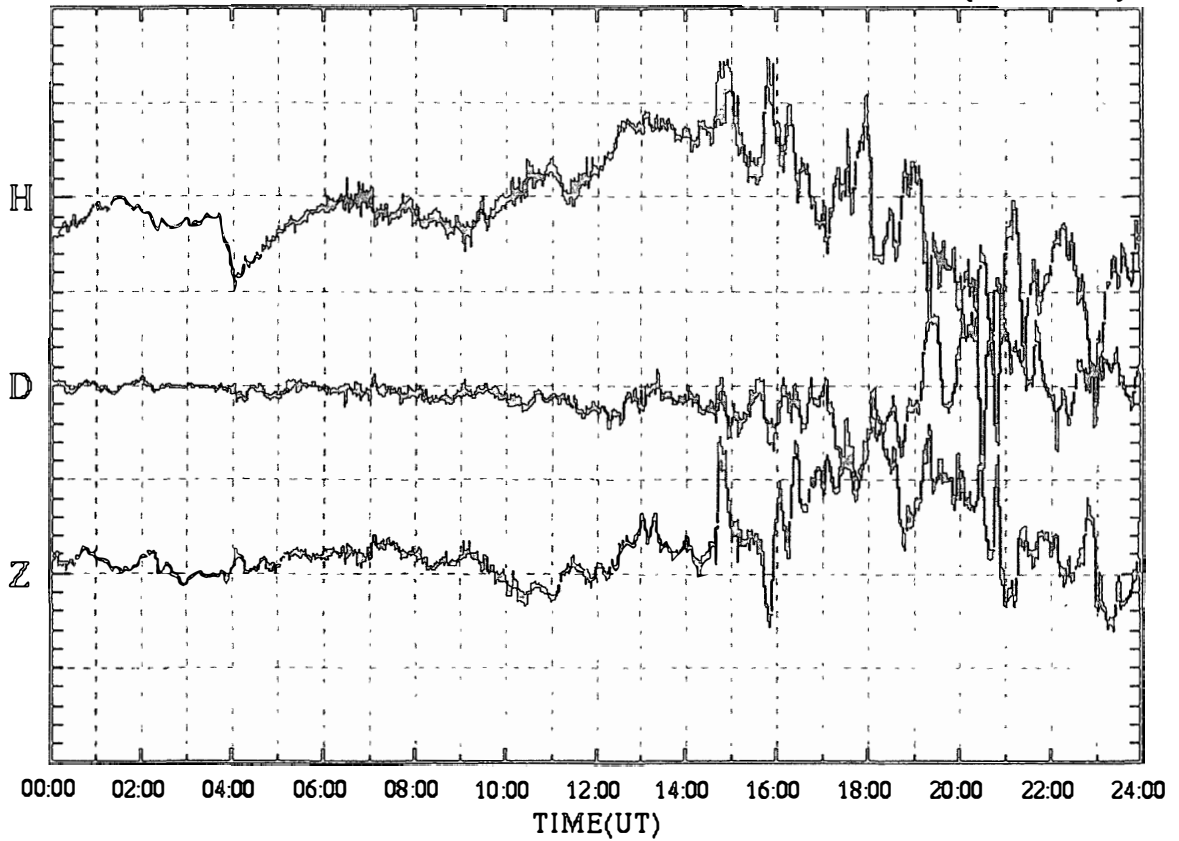

SYOWA magnetogram (100 nT/div)

16 Jul.2000 (DAY:198)

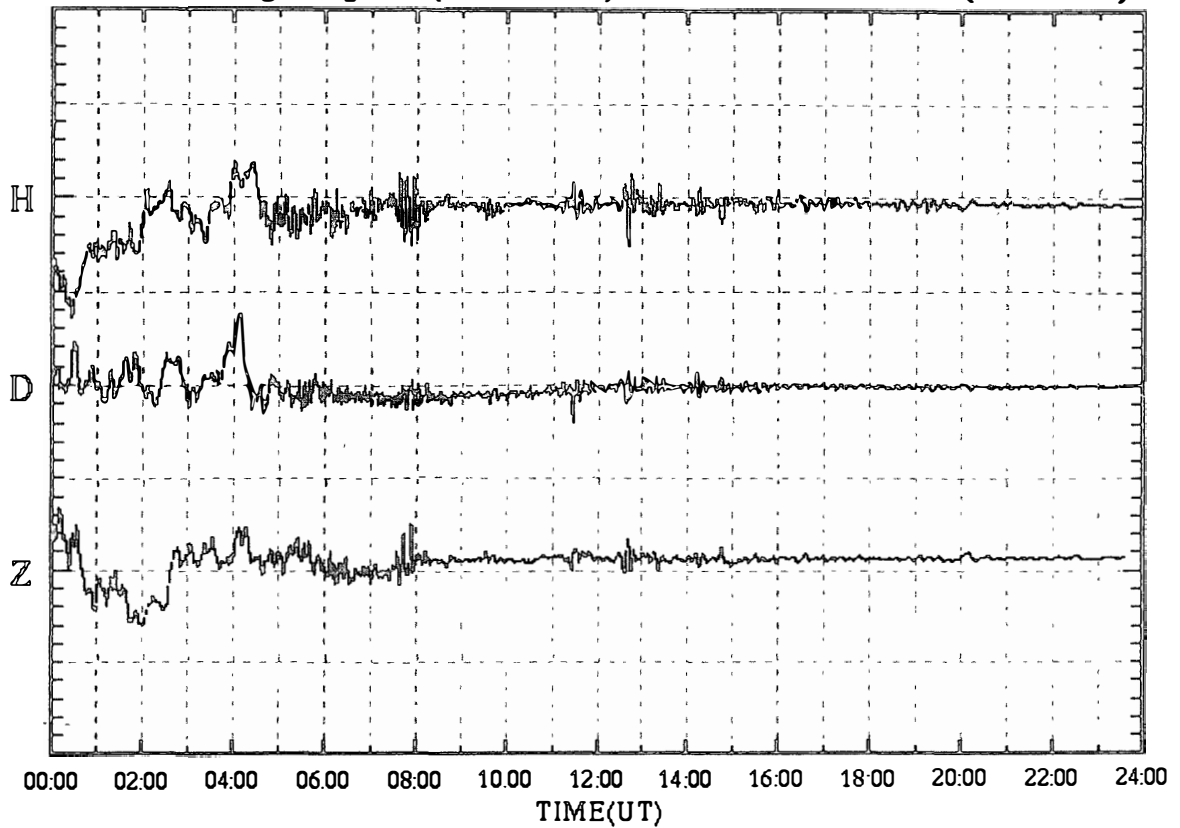

SYOWA magnetogram (100 nT/div)

17 Jul.2000 (DAY:199)

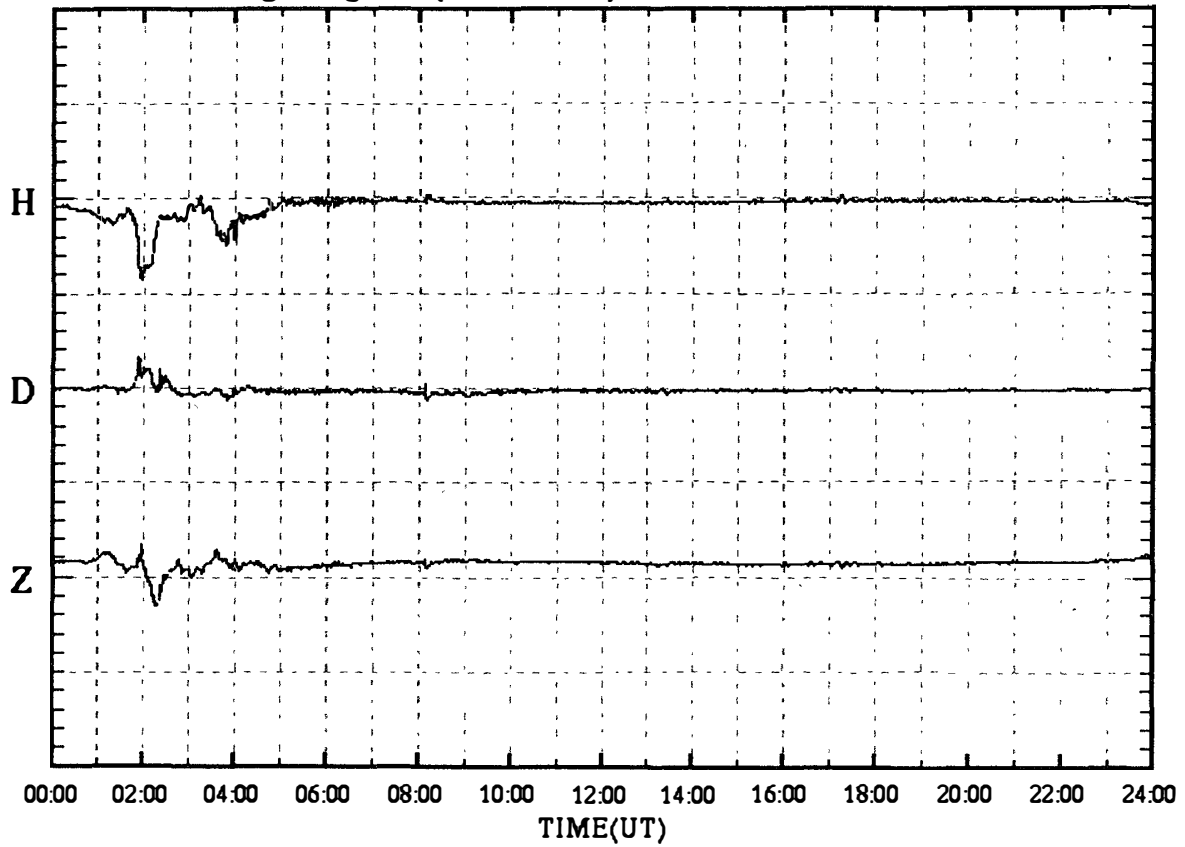

SYOWA magnetogram (100 nT/div)

18 Jul.2000 (DAY:200)

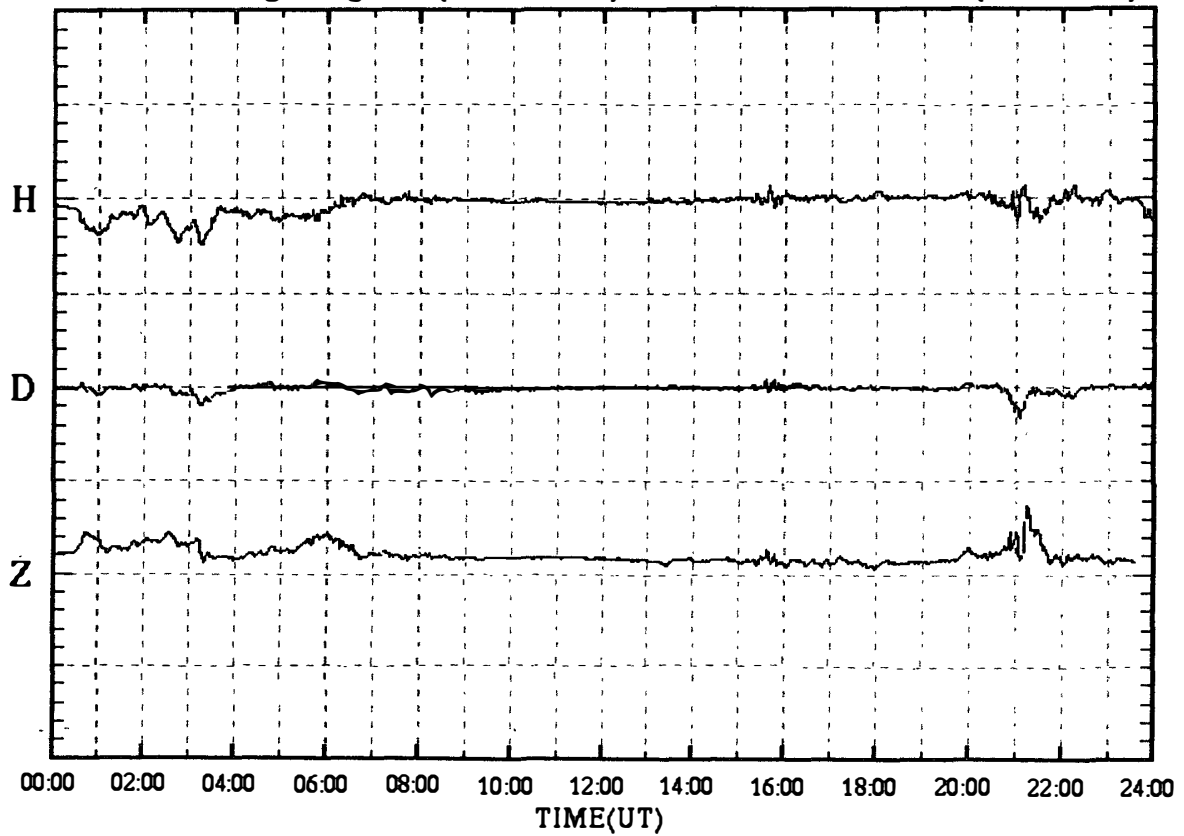

SYOWA magnetogram (100 nT/div)

19 Jul.2000 (DAY:201)

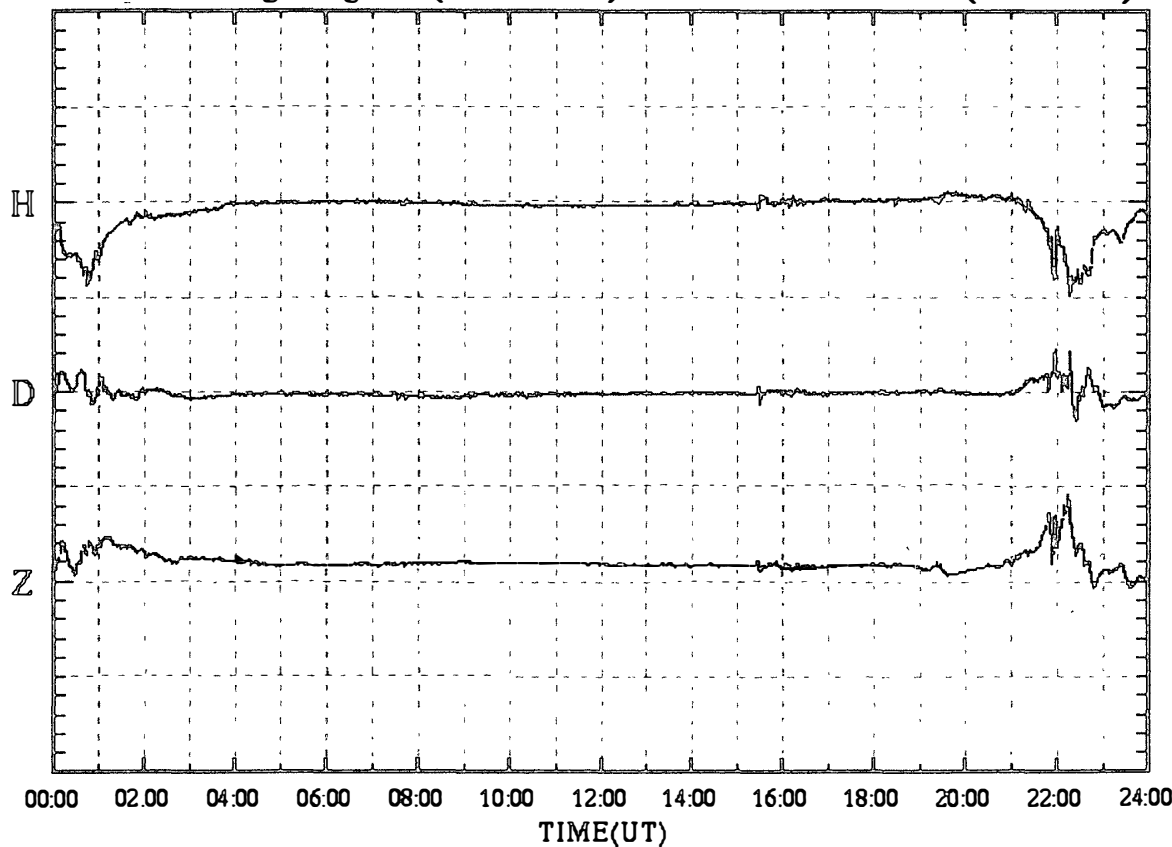

SYOWA magnetogram (100 nT/div)

20 Jul.2000 (DAY:202)

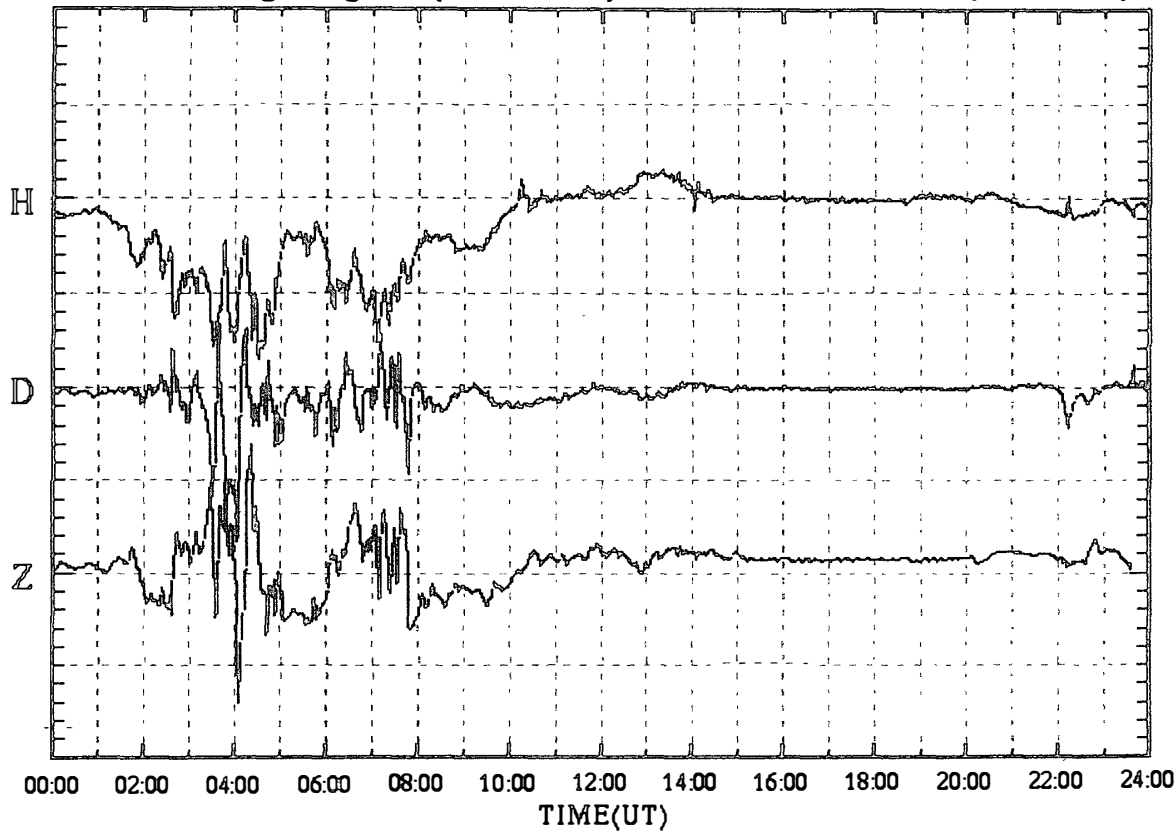

SYOWA magnetogram (100 nT/div)

21 Jul.2000 (DAY:203)

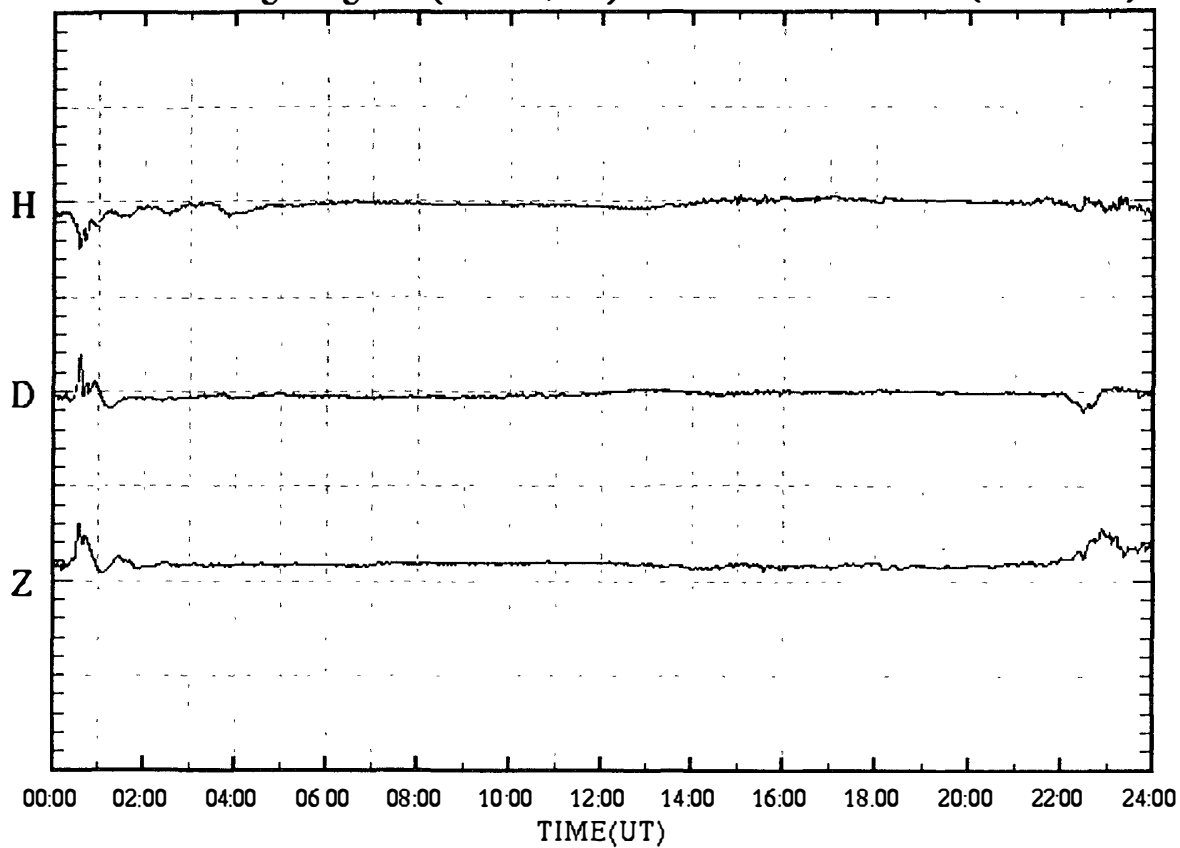

SYOWA magnetogram (100 nT/div)

22 Jul.2000 (DAY:204)

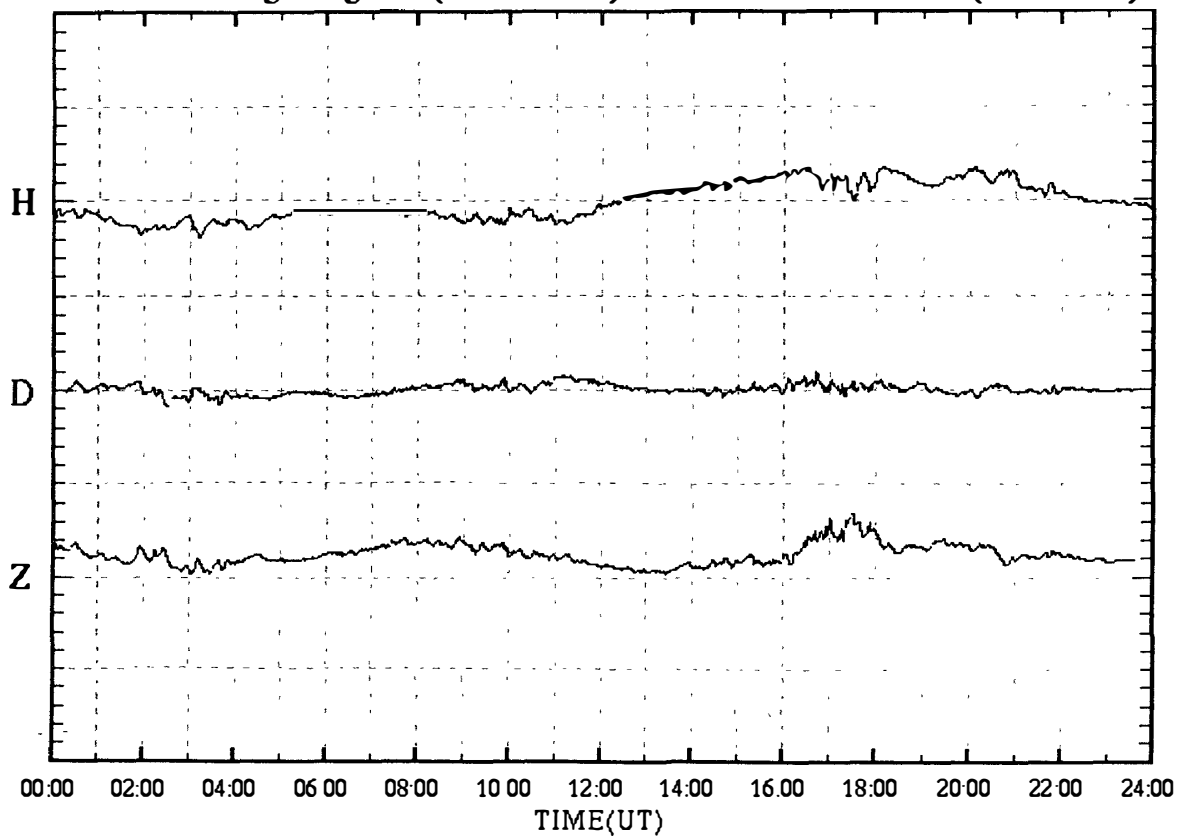

SYOWA magnetogram (100 nT/div)

23 Jul.2000 (DAY:205)

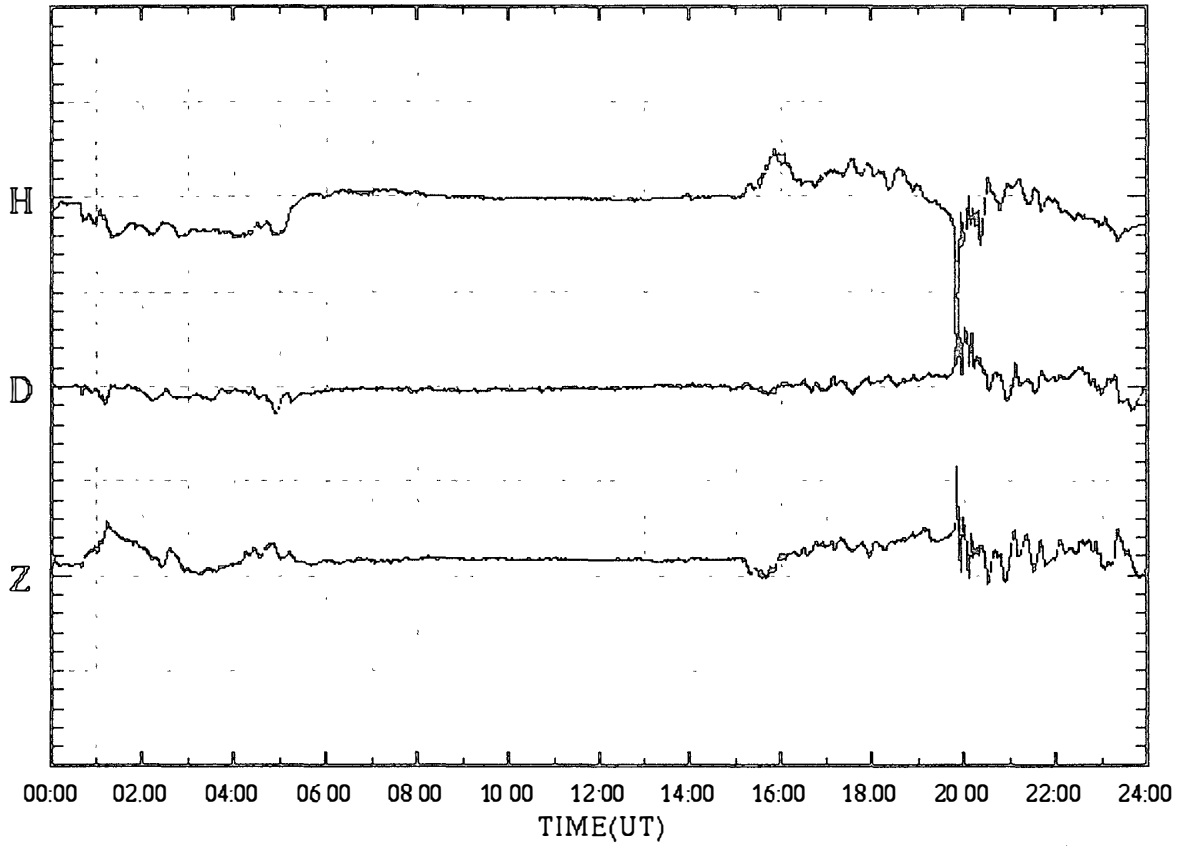

SYOWA magnetogram (100 nT/div)

24 Jul.2000 (DAY:206)

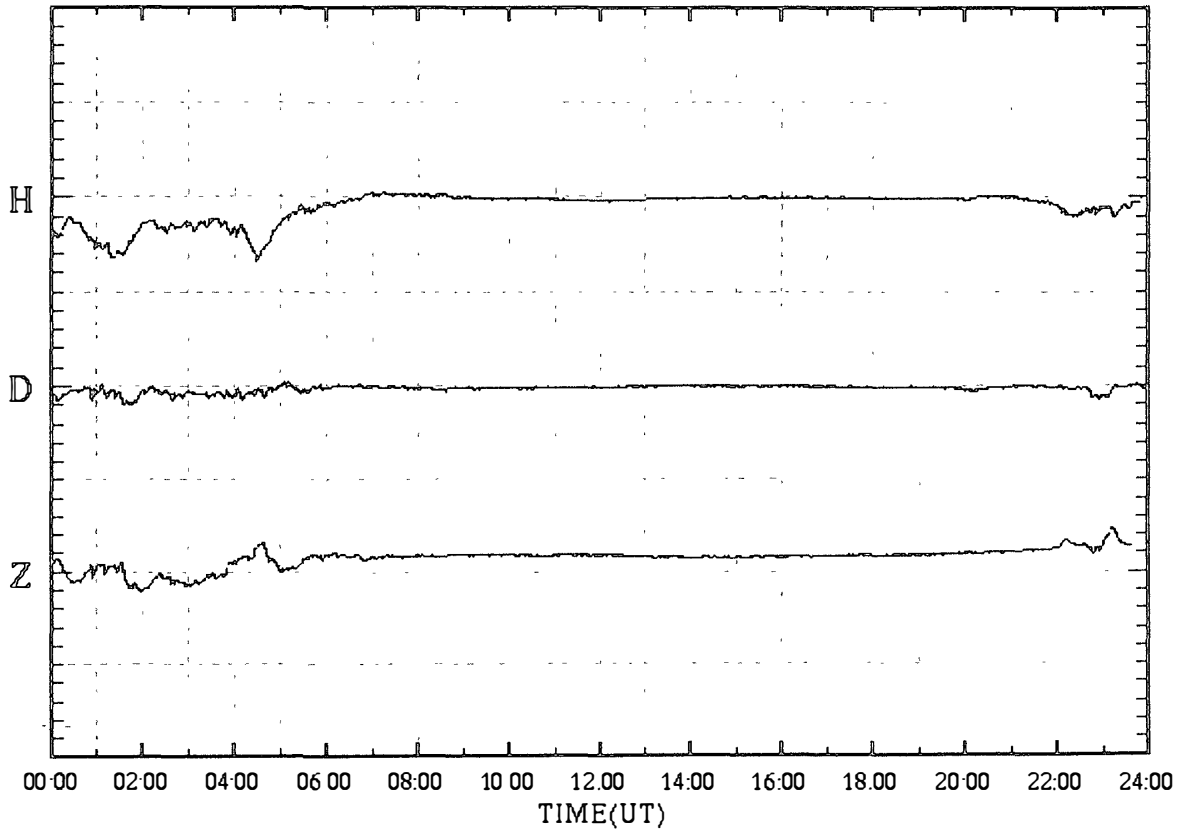

SYOWA magnetogram (100 nT/div)

25 Jul.2000 (DAY:207)

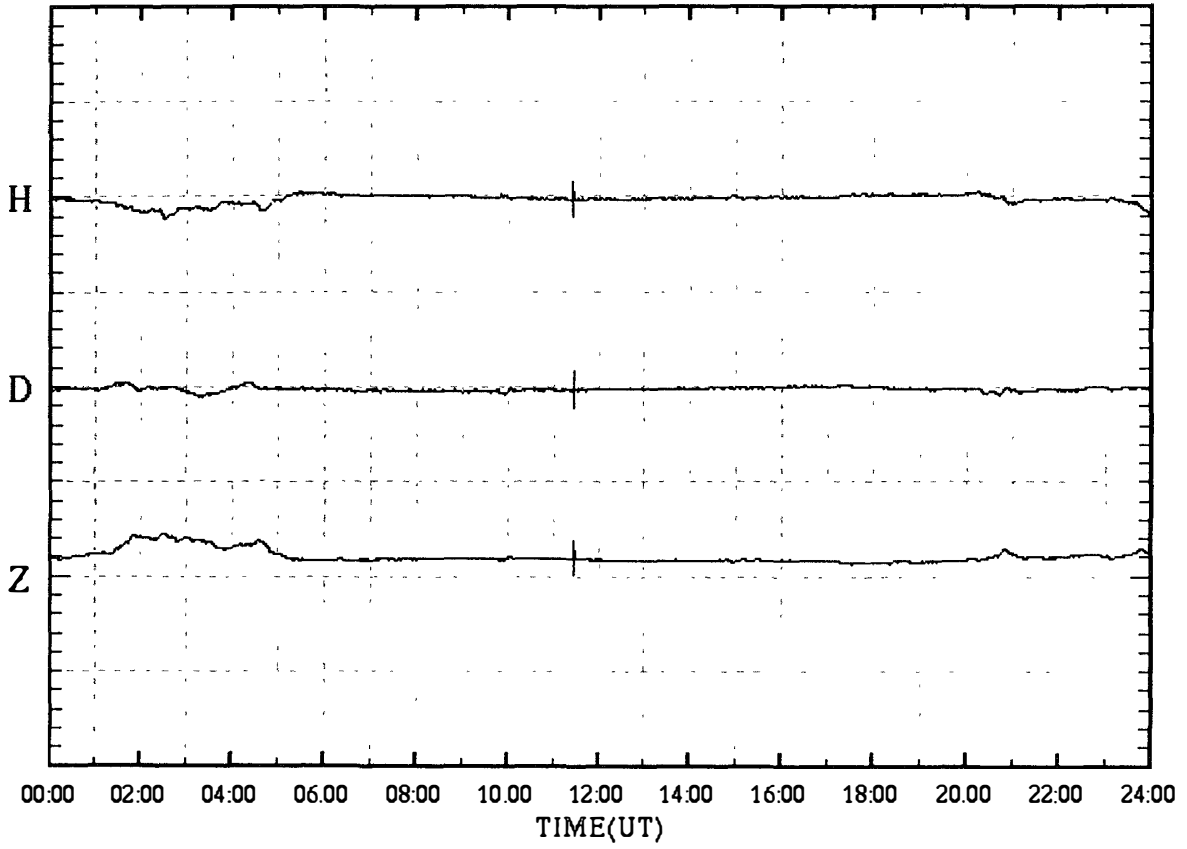

SYOWA magnetogram (100 nT/div)

26 Jul.2000 (DAY:208)

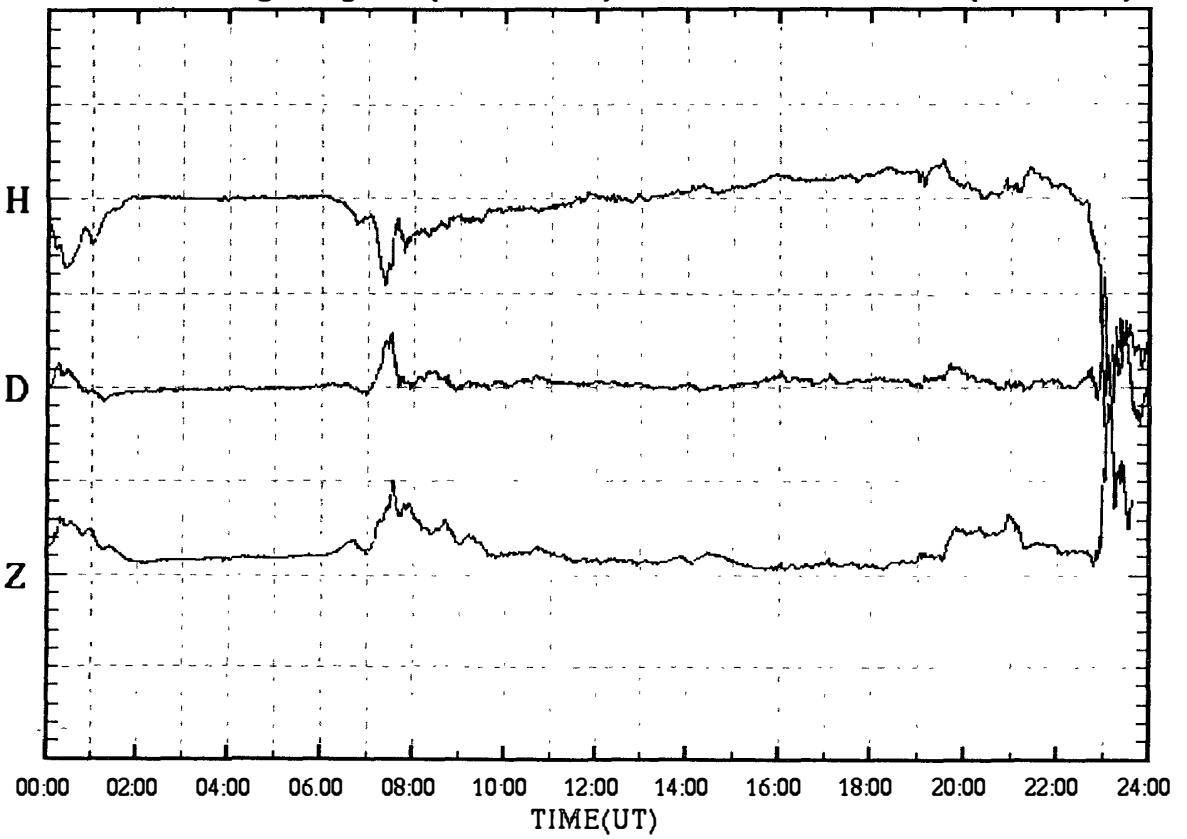

SYOWA magnetogram (100 nT/div)

27 Jul.2000 (DAY:209)

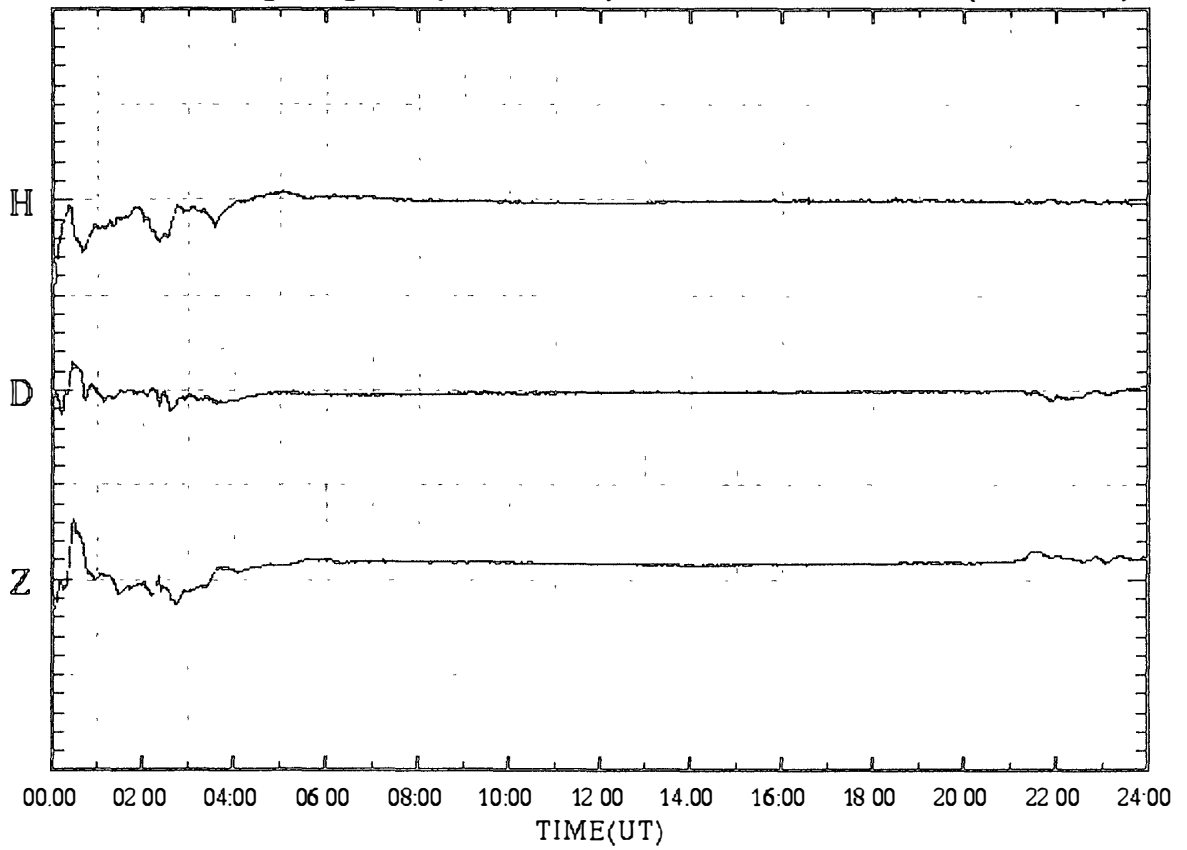

SYOWA magnetogram (100 nT/div)

28 Jul.2000 (DAY:210)

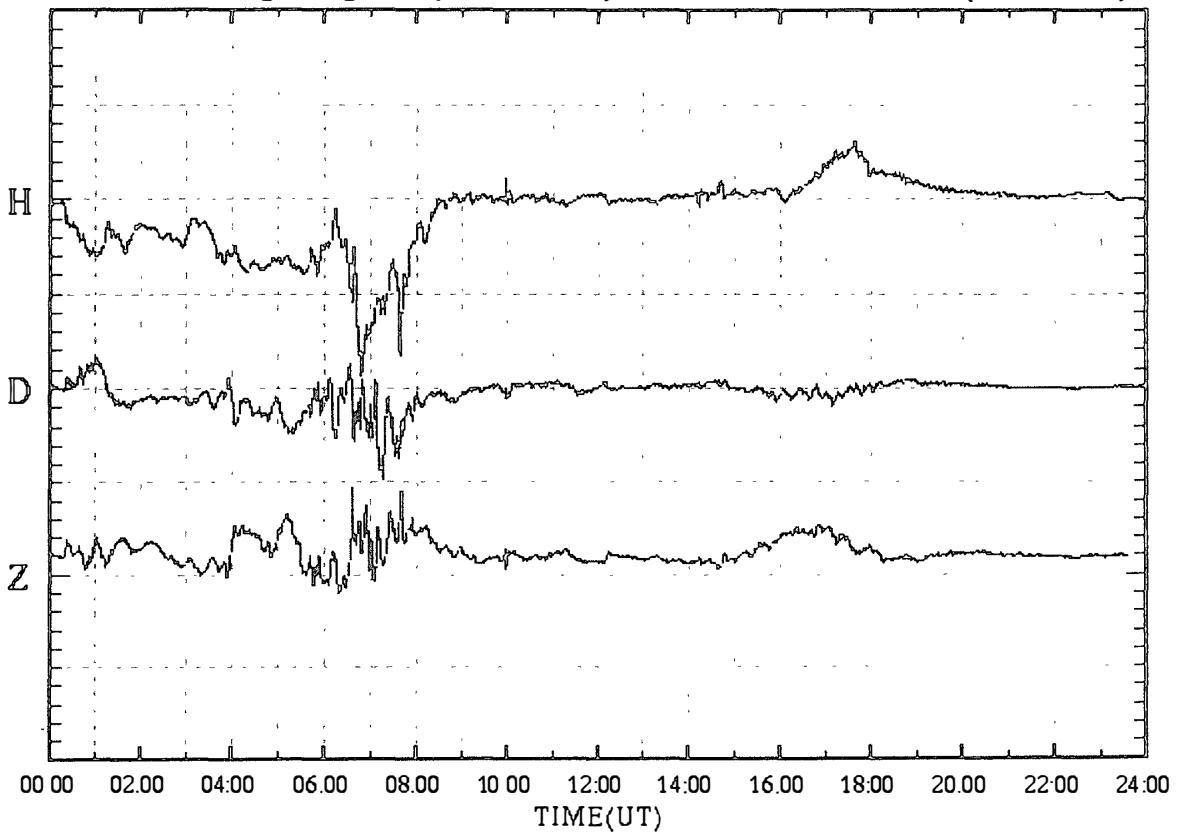

SYOWA magnetogram (100 nT/div)

29 Jul.2000 (DAY:211)

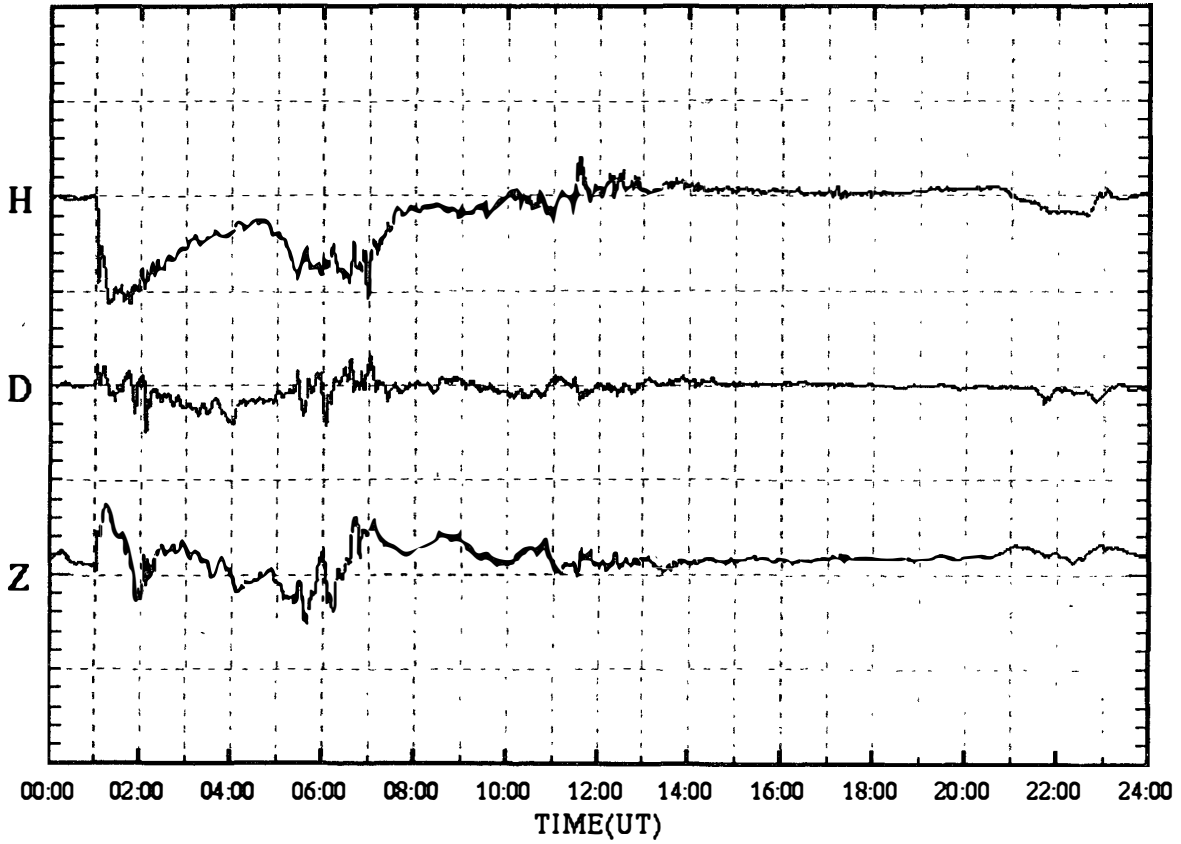

SYOWA magnetogram (100 nT/div)

30 Jul.2000 (DAY:212)

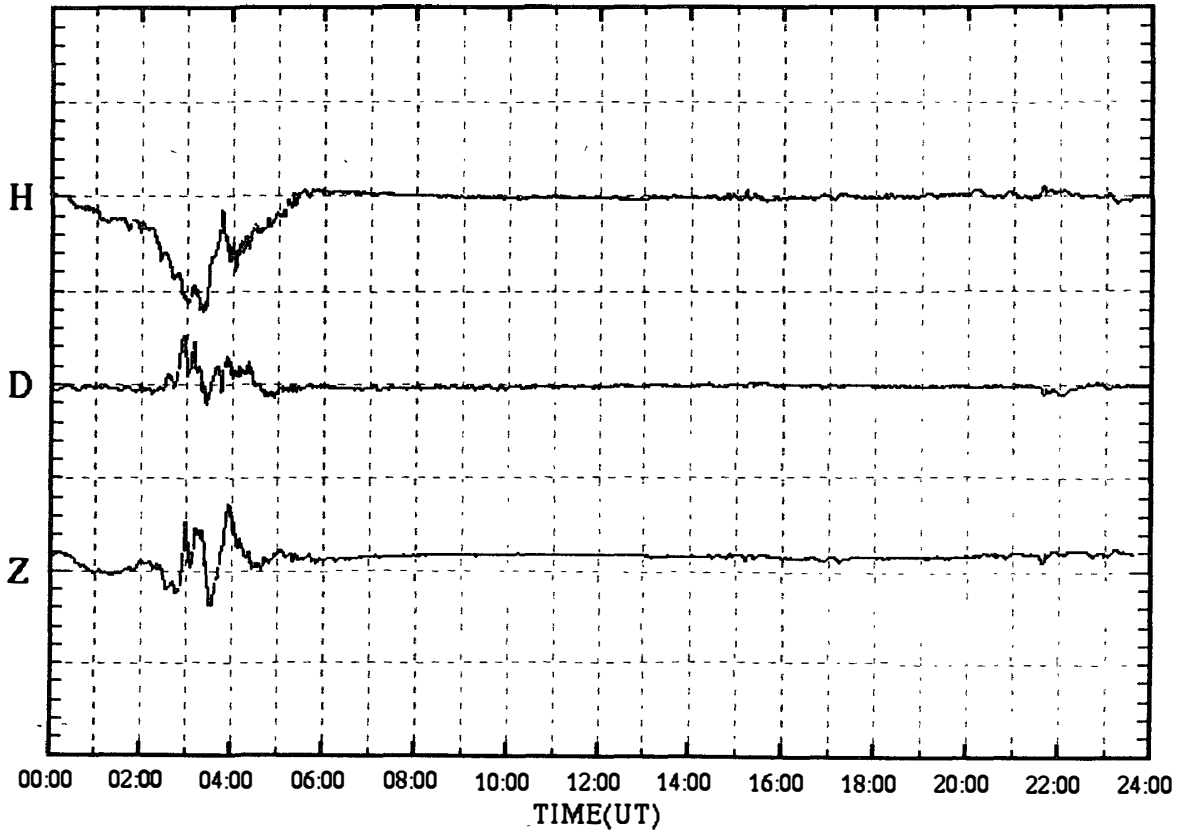

SYOWA magnetogram (100 nT/div)

31 Jul.2000 (DAY:213)

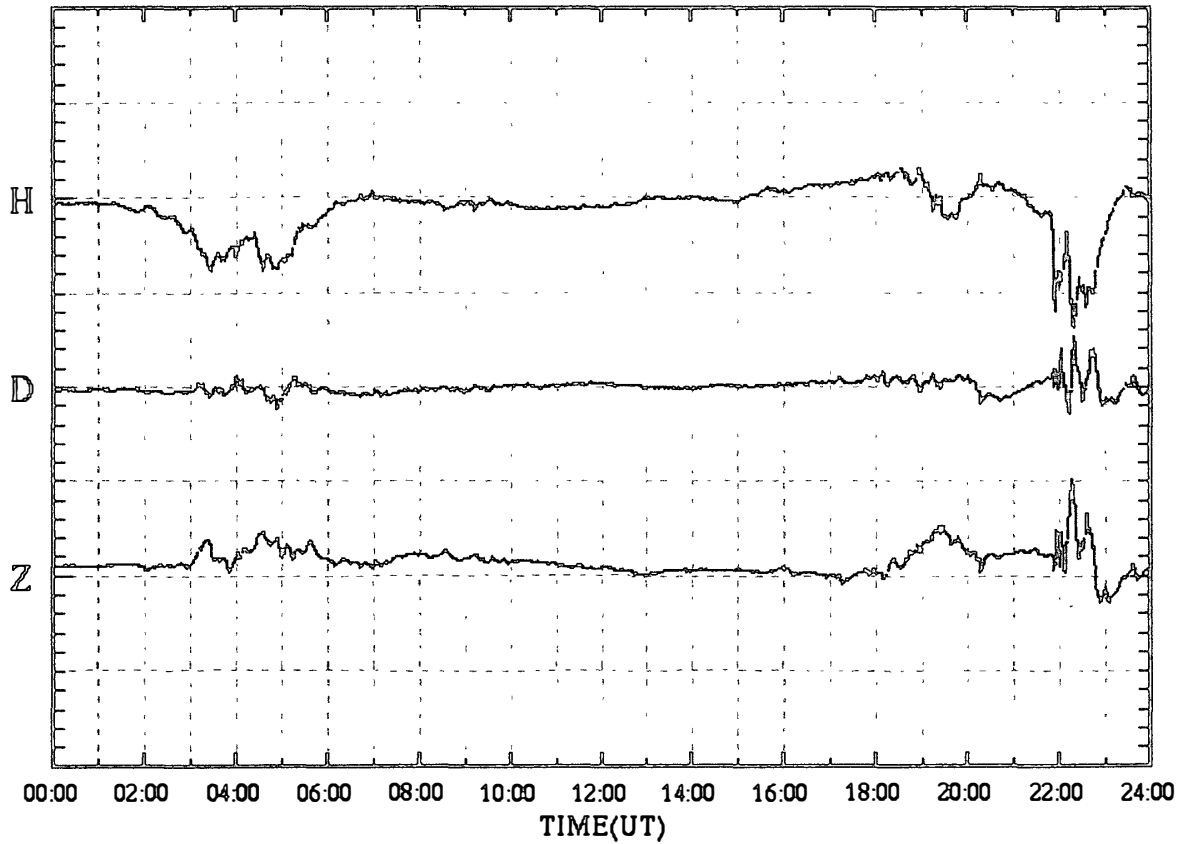

SYOWA magnetogram (100 nT/div)

01 Aug.2000 (DAY:214)

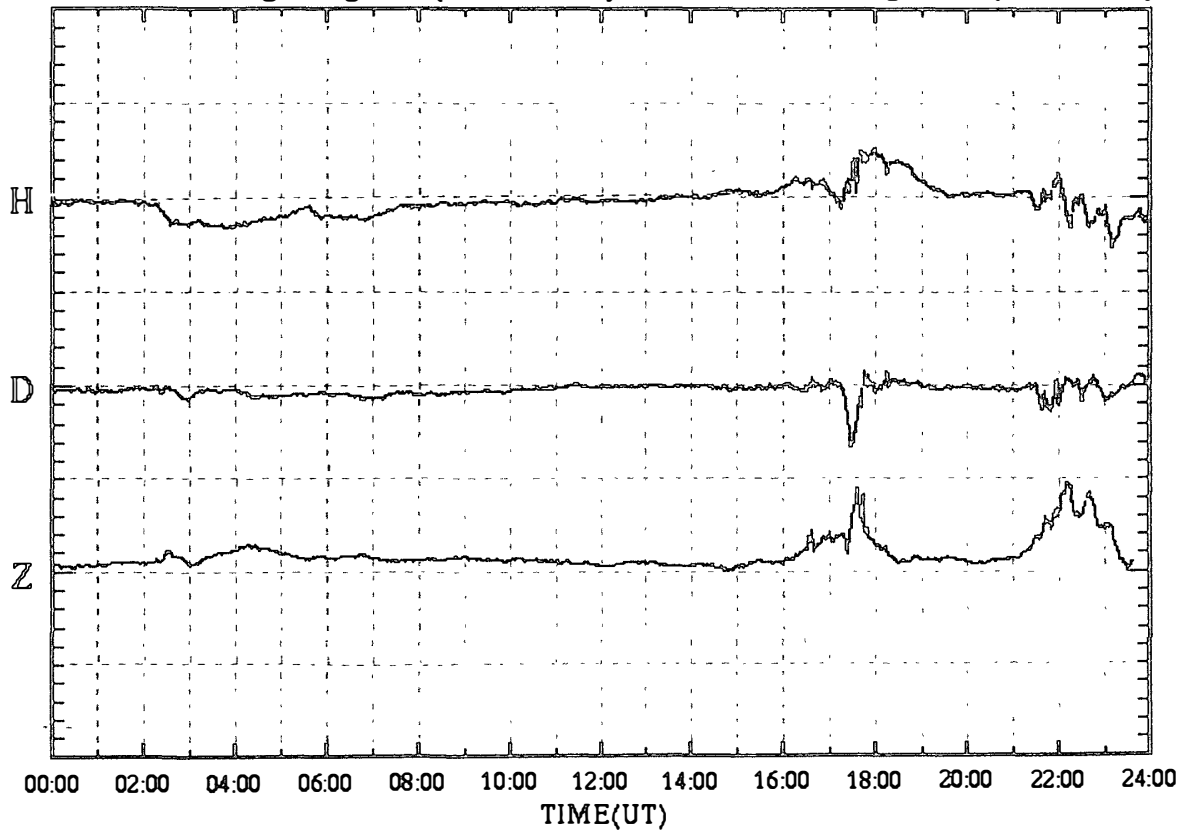

SYOWA magnetogram (100 nT/div)

02 Aug.2000 (DAY:215)

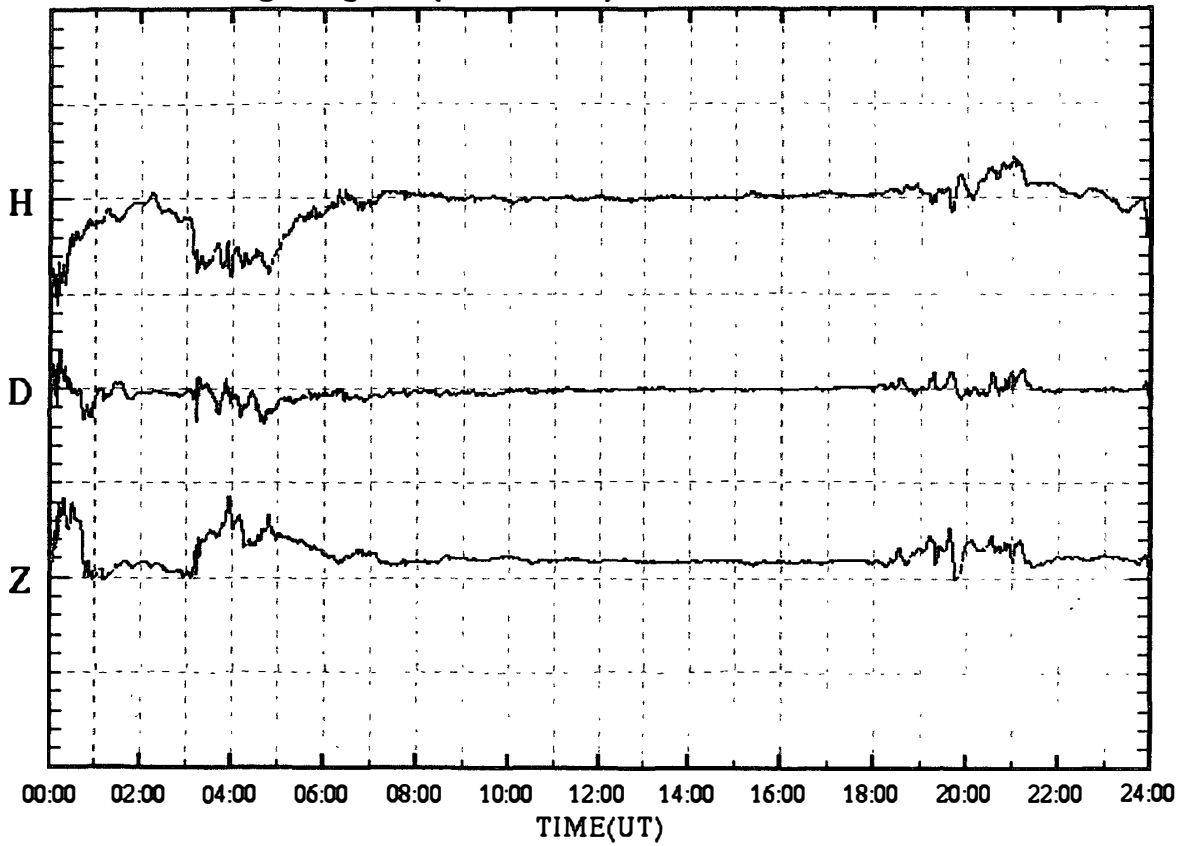

SYOWA magnetogram (100 nT/div)

03 Aug.2000 (DAY:216)

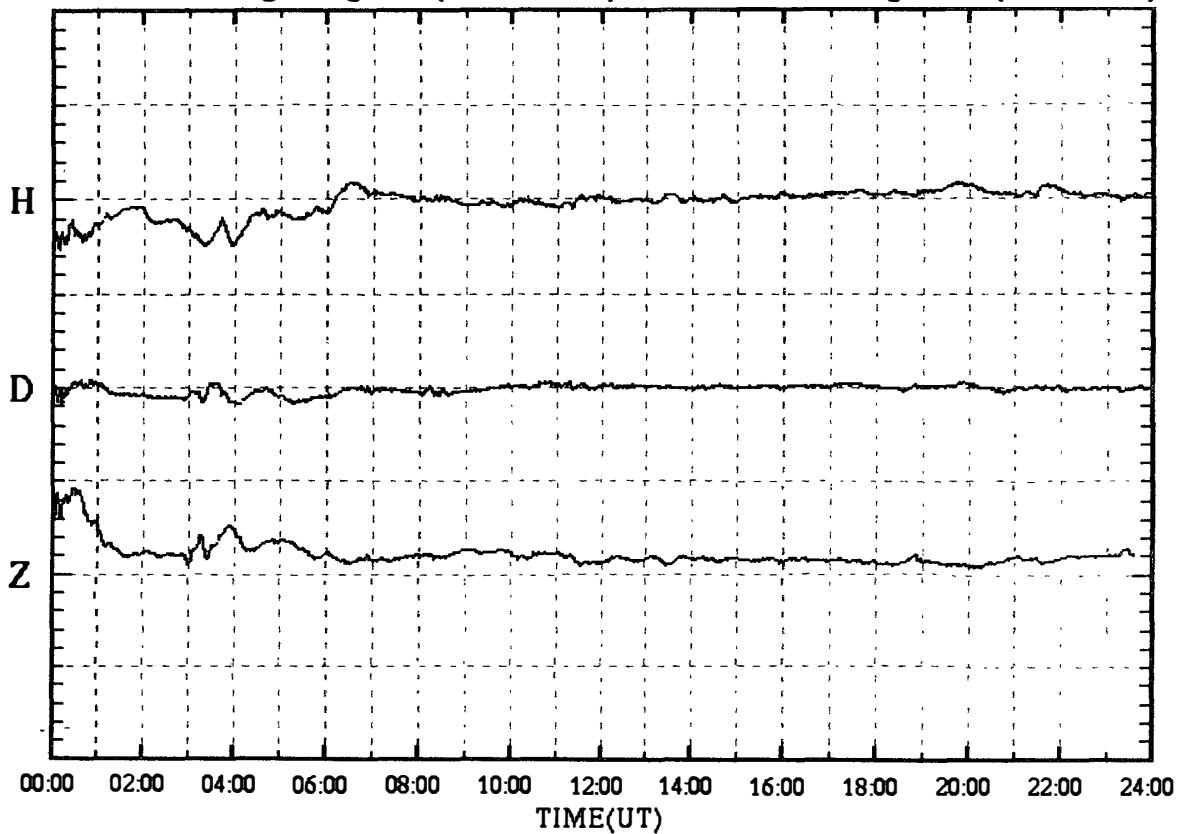

SYOWA magnetogram (100 nT/div)

04 Aug.2000 (DAY:217)

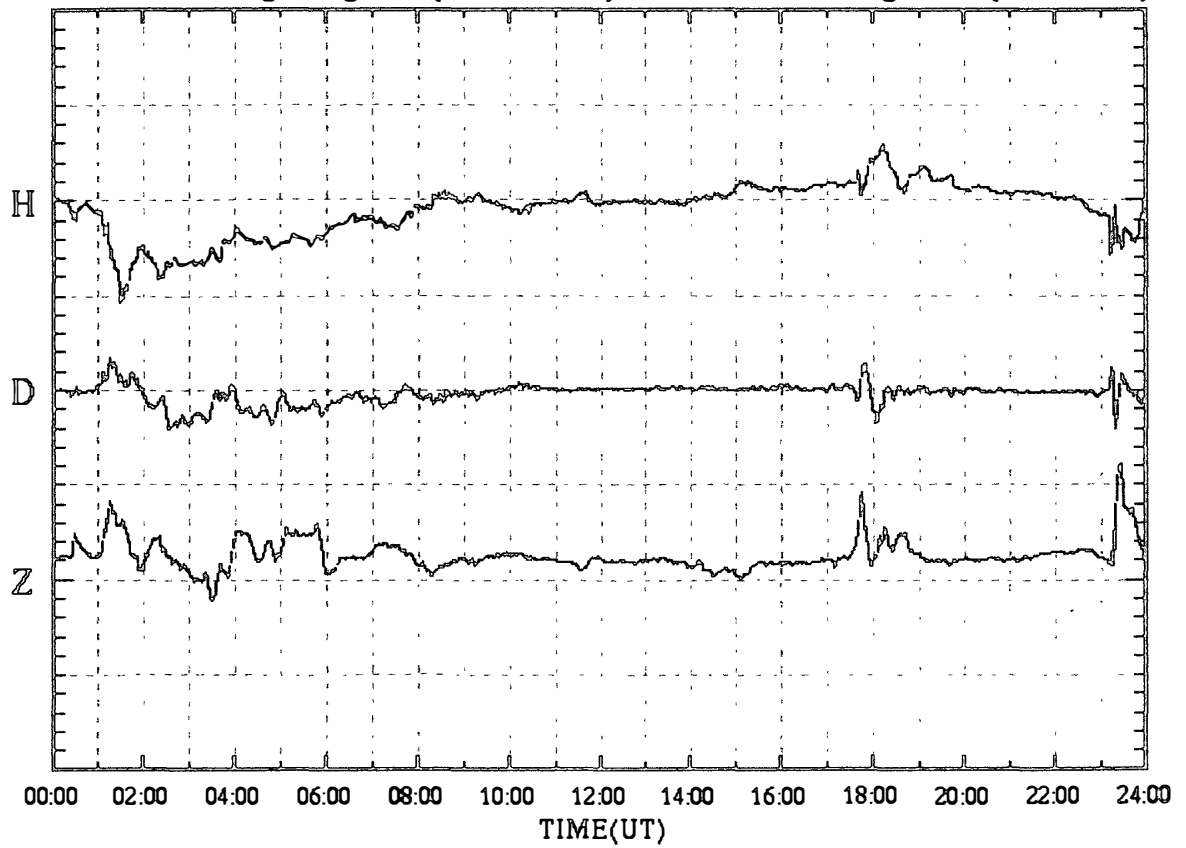

SYOWA magnetogram (100 nT/div)

05 Aug.2000 (DAY:218)

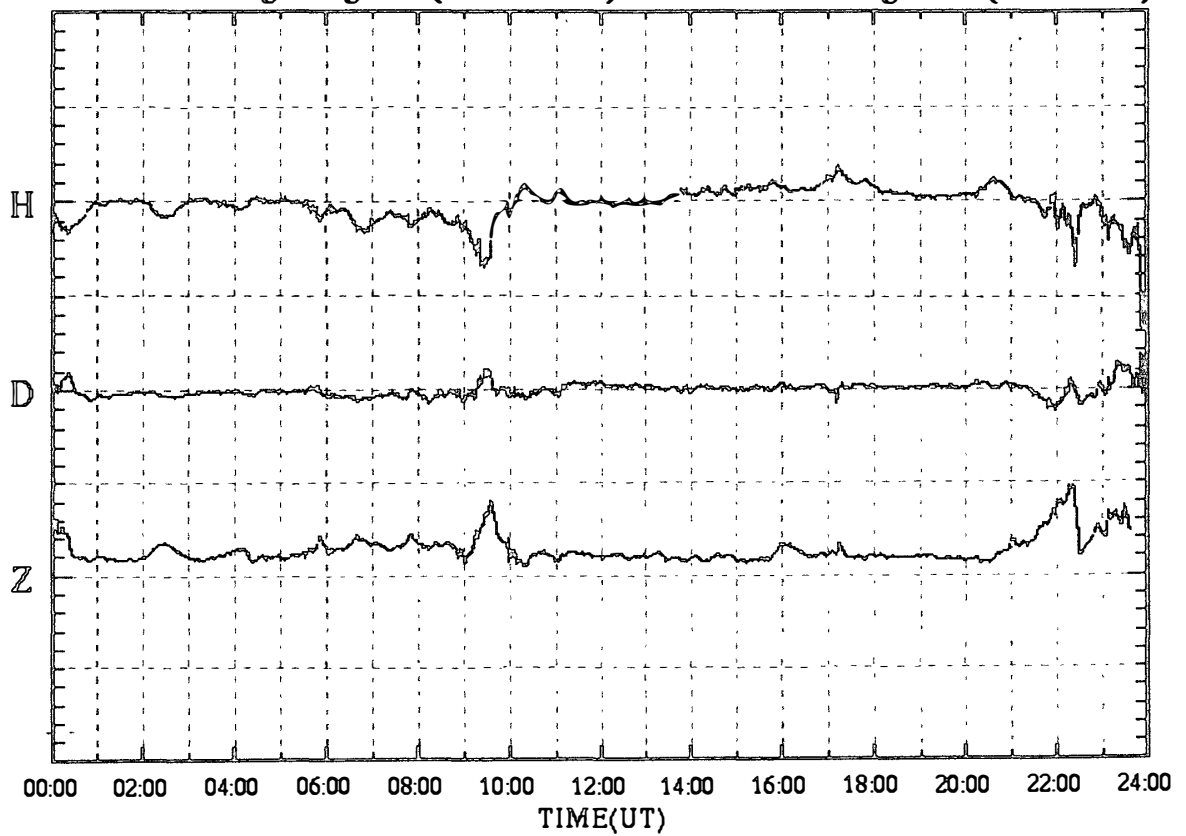

SYOWA magnetogram (100 nT/div)

06 Aug.2000 (DAY:219)

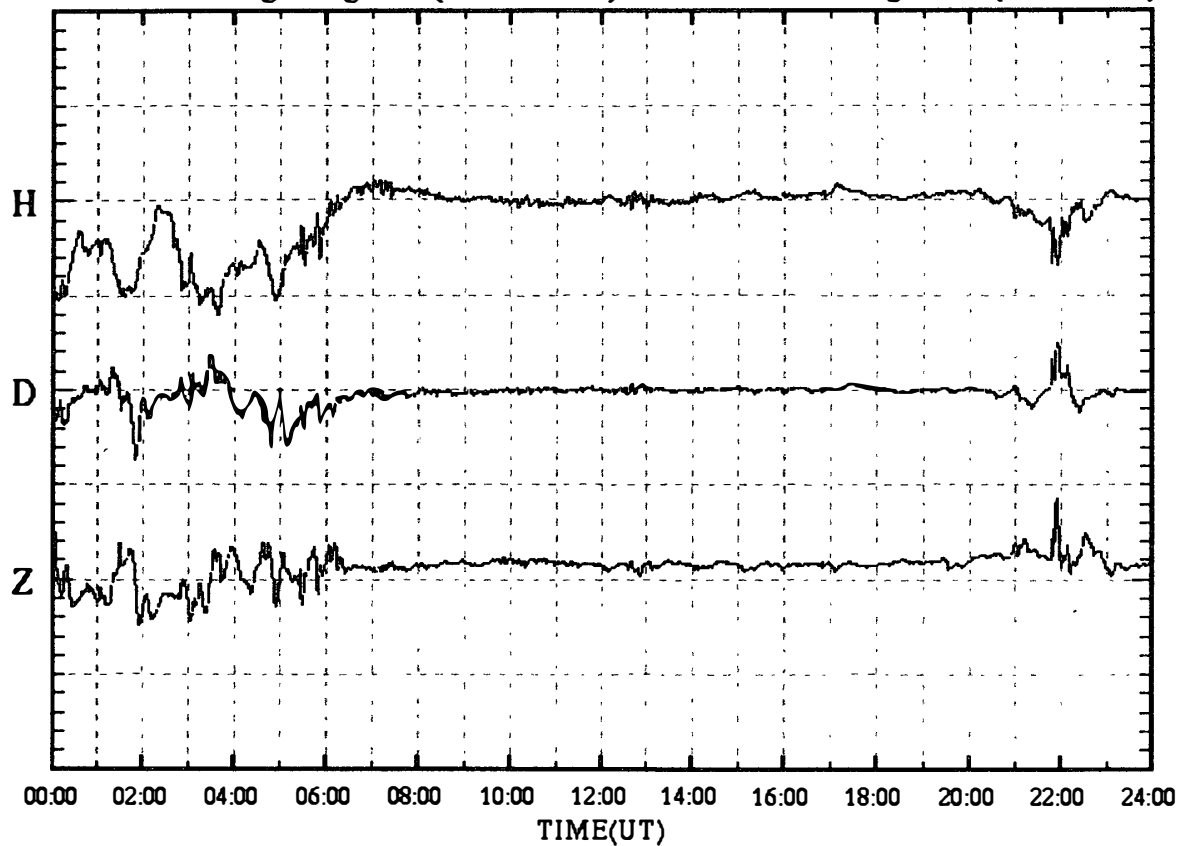

SYOWA magnetogram (100 nT/div)

07 Aug.2000 (DAY:220)

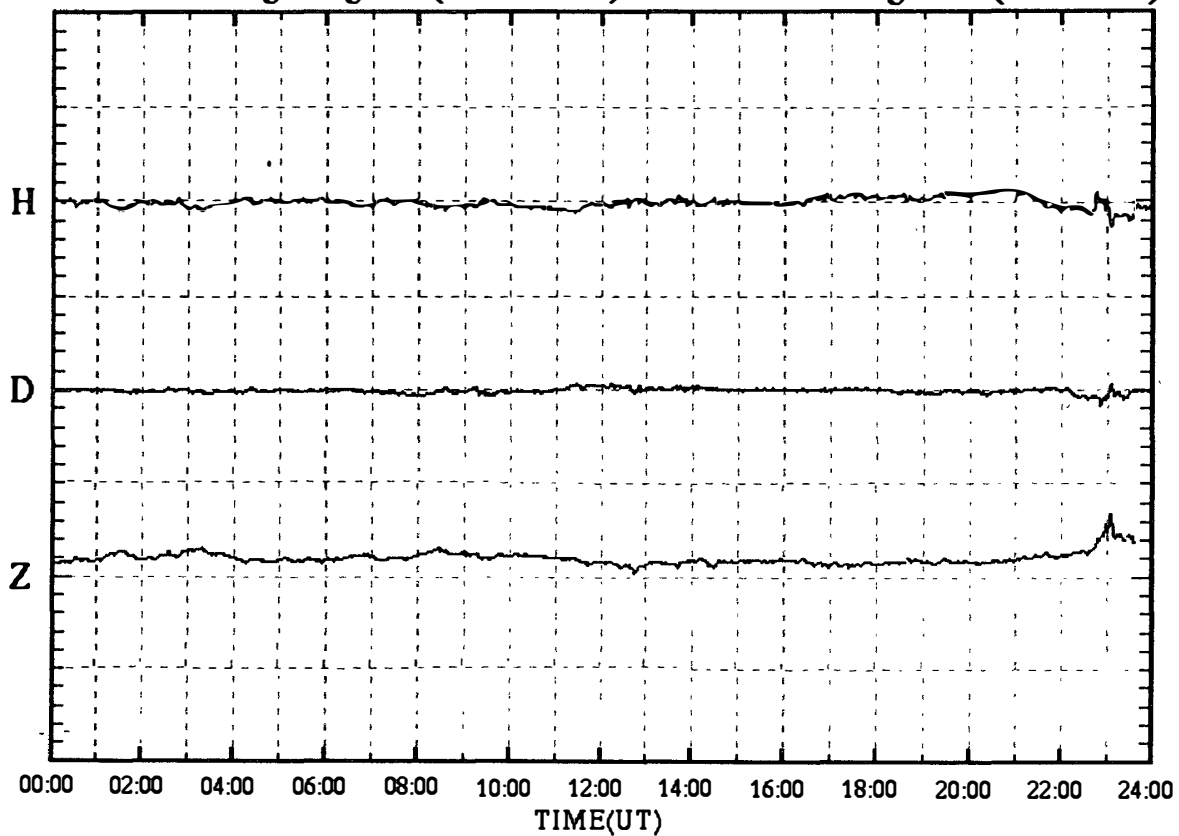

SYOWA magnetogram (100 nT/div)

08 Aug.2000 (DAY:221)

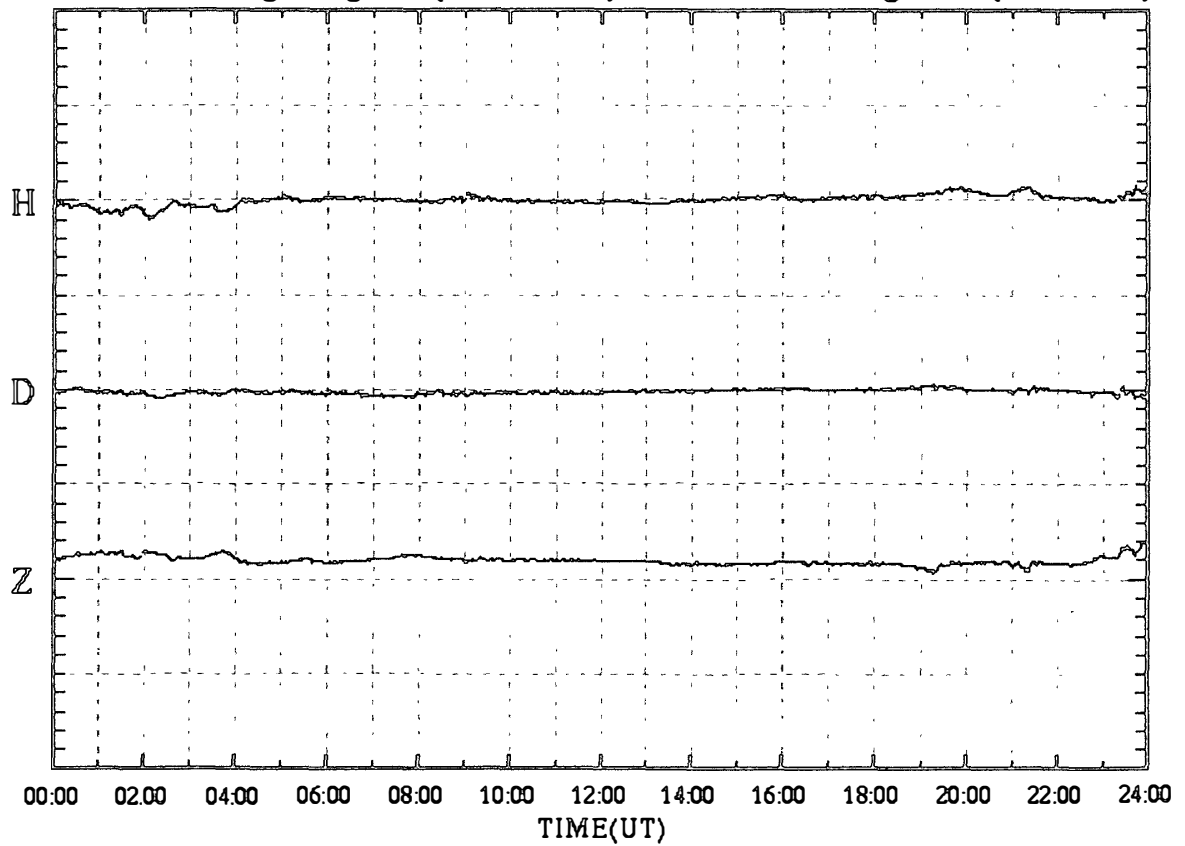

SYOWA magnetogram (100 nT/div)

09 Aug.2000 (DAY:222)

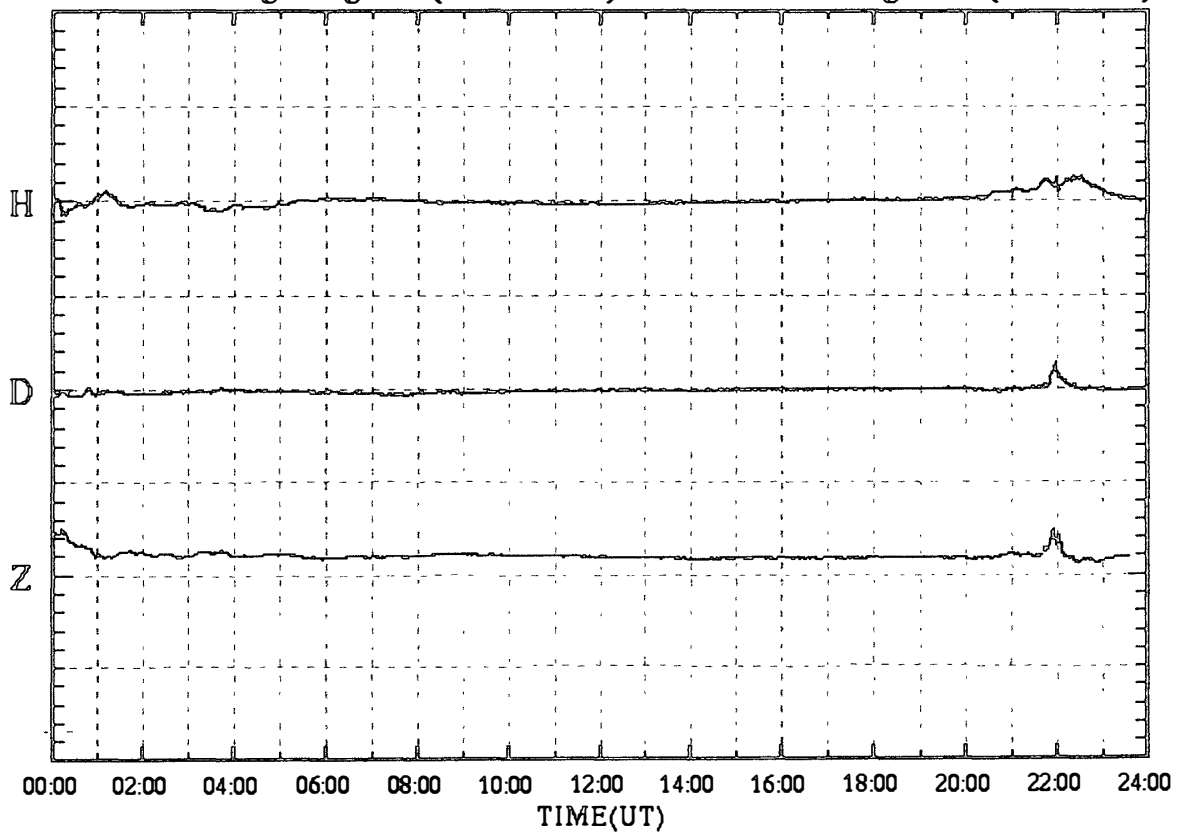

SYOWA magnetogram (100 nT/div)

10 Aug.2000 (DAY:223)

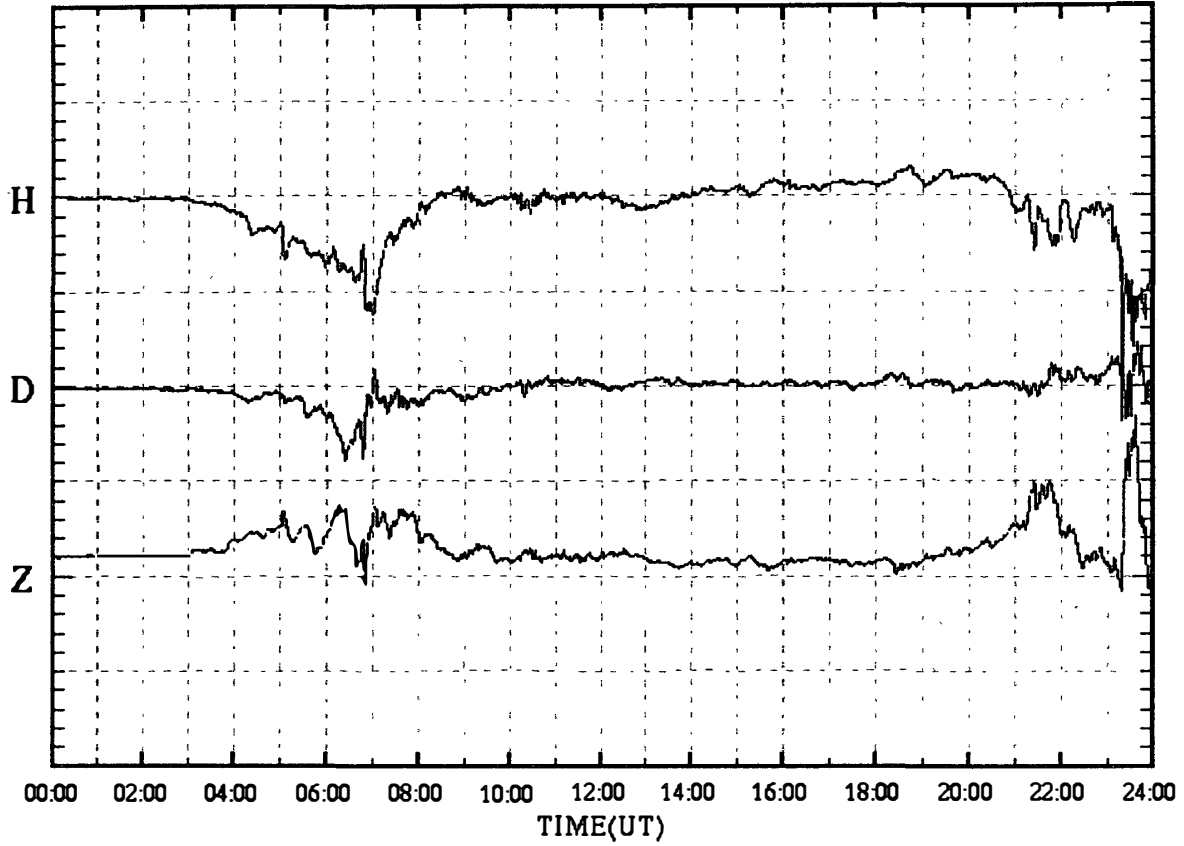

SYOWA magnetogram (100 nT/div)

11 Aug.2000 (DAY:224)

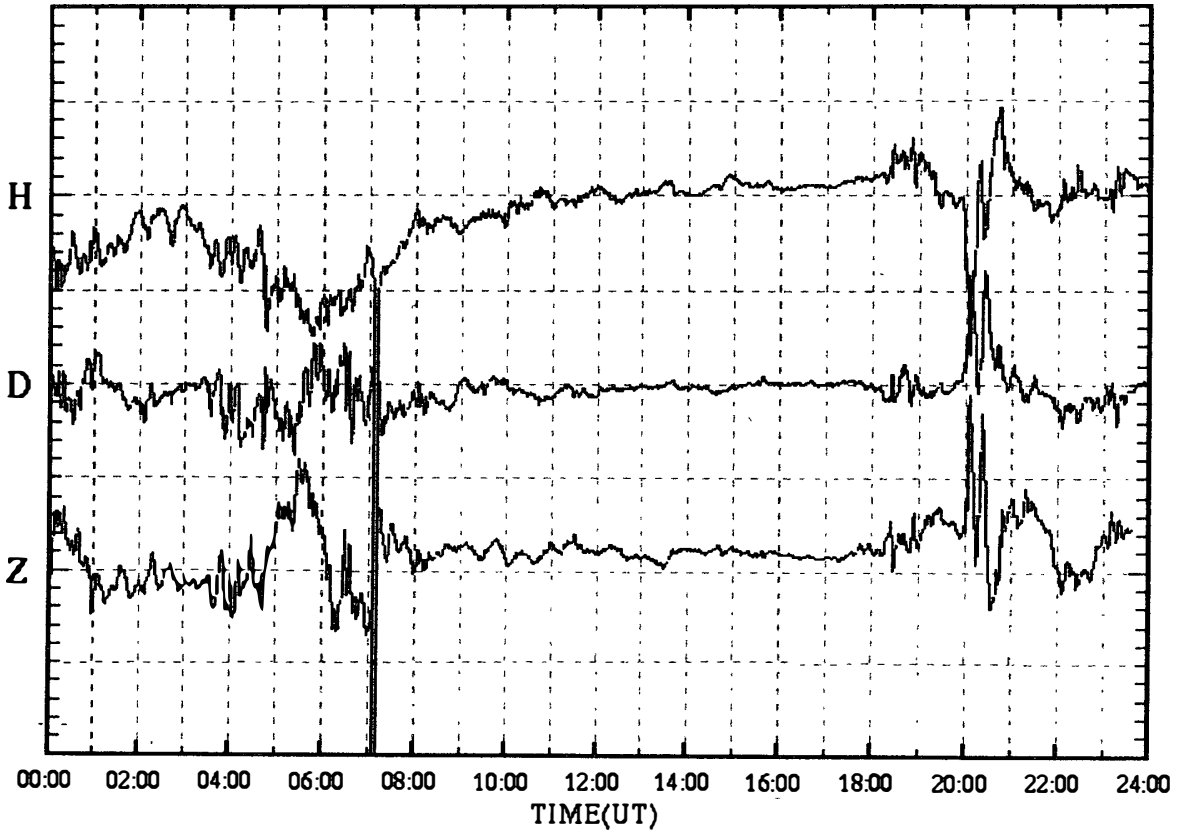

SYOWA magnetogram (100 nT/div)

12 Aug.2000 (DAY:225)

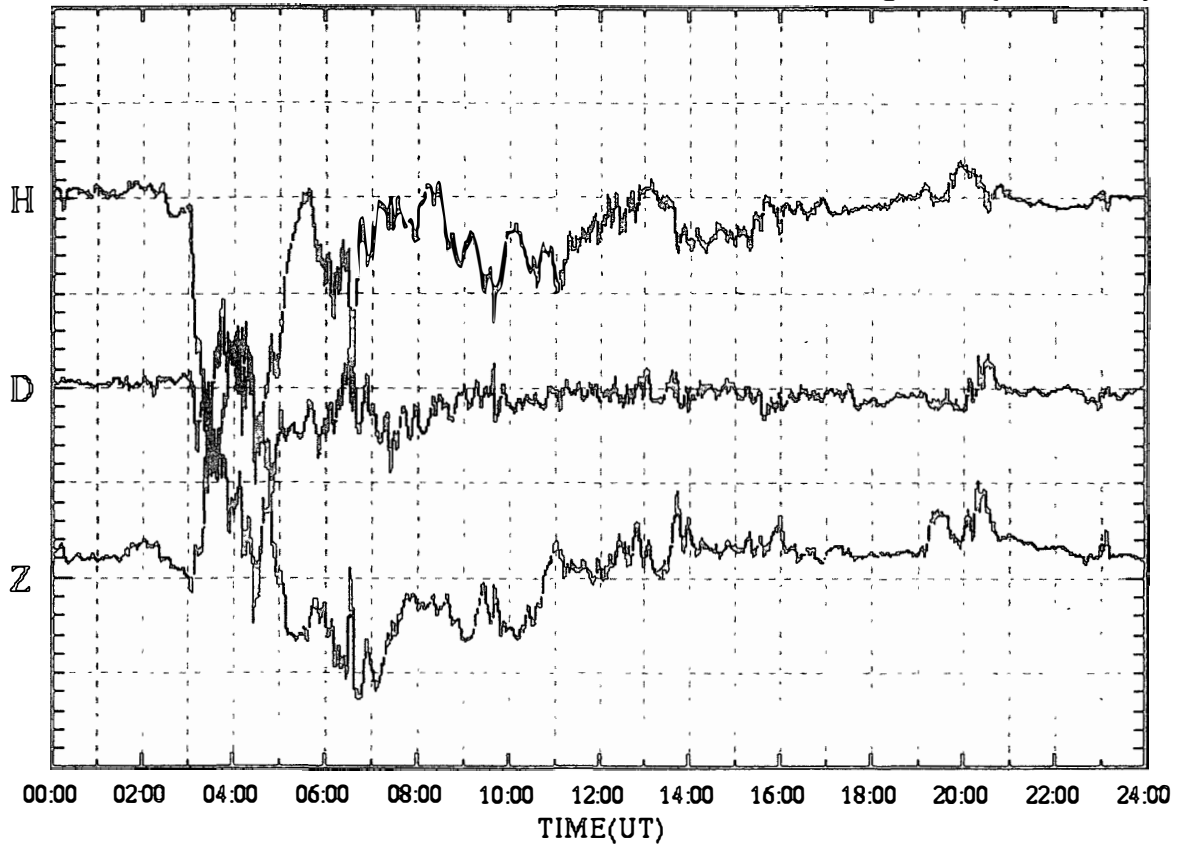

SYOWA magnetogram (100 nT/div)

13 Aug.2000 (DAY:226)

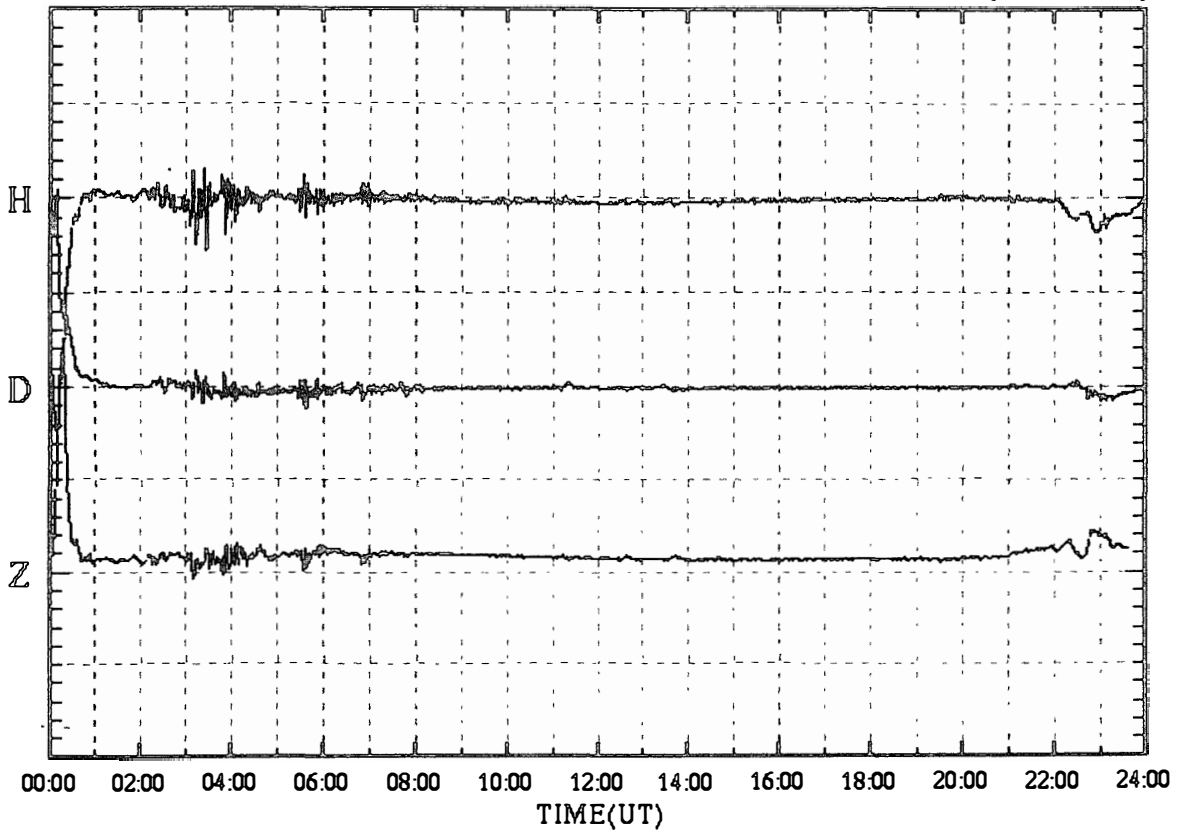

SYOWA magnetogram (100 nT/div)

14 Aug.2000 (DAY:227)

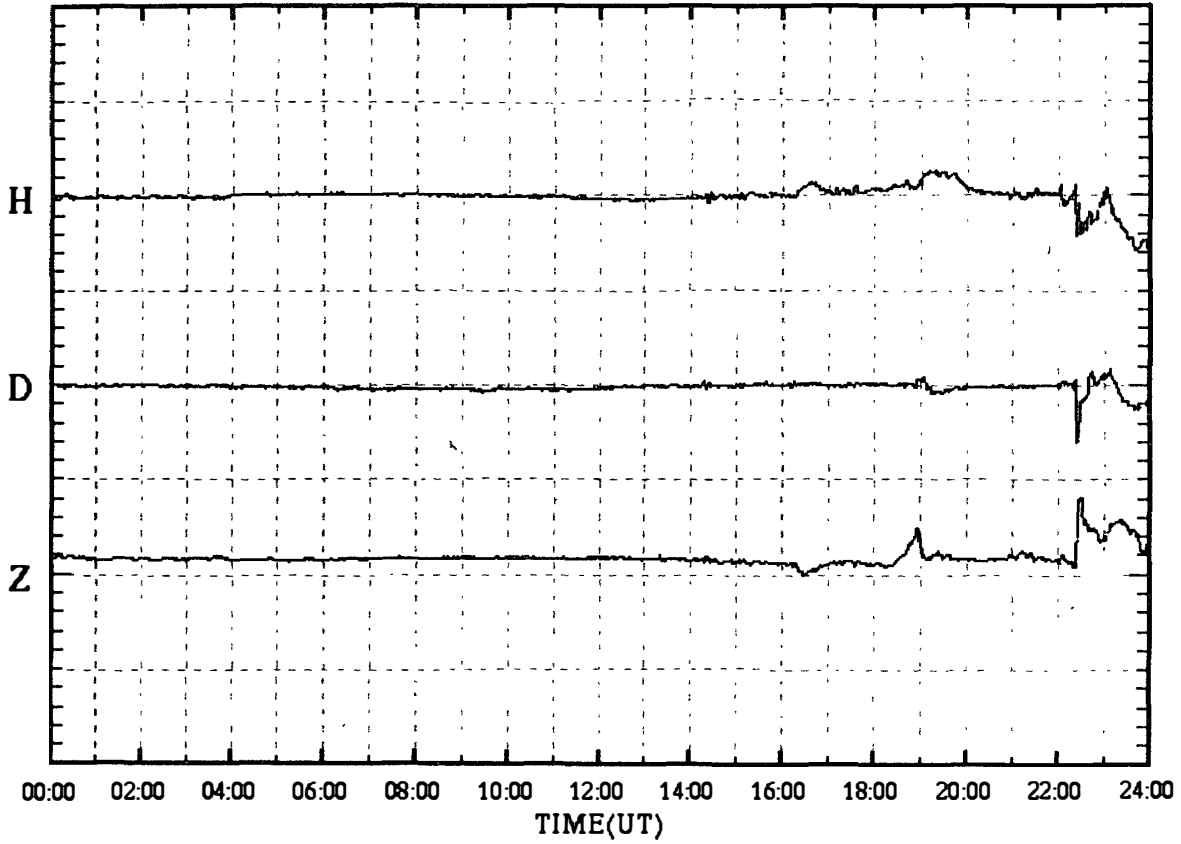

SYOWA magnetogram (100 nT/div)

15 Aug.2000 (DAY:228)

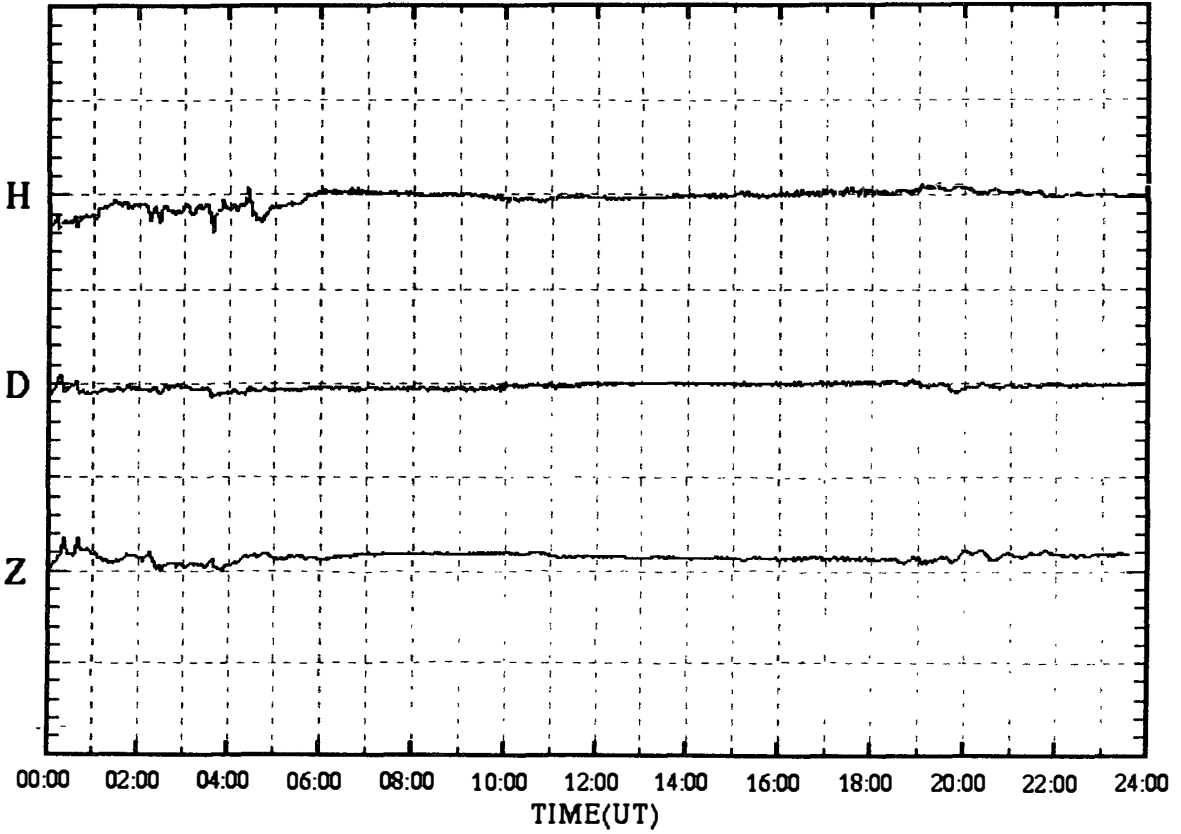

SYOWA magnetogram (100 nT/div)

16 Aug.2000 (DAY:229)

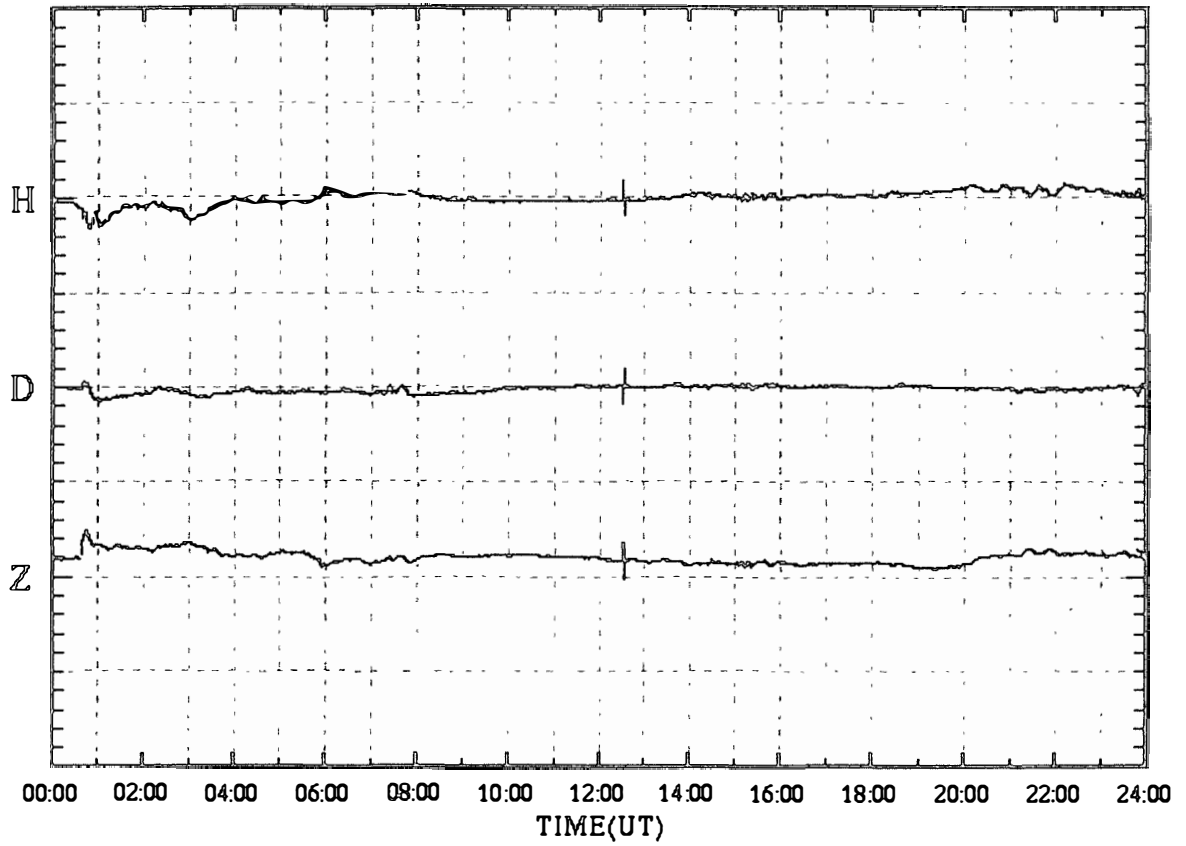

SYOWA magnetogram (100 nT/div)

17 Aug.2000 (DAY:230)

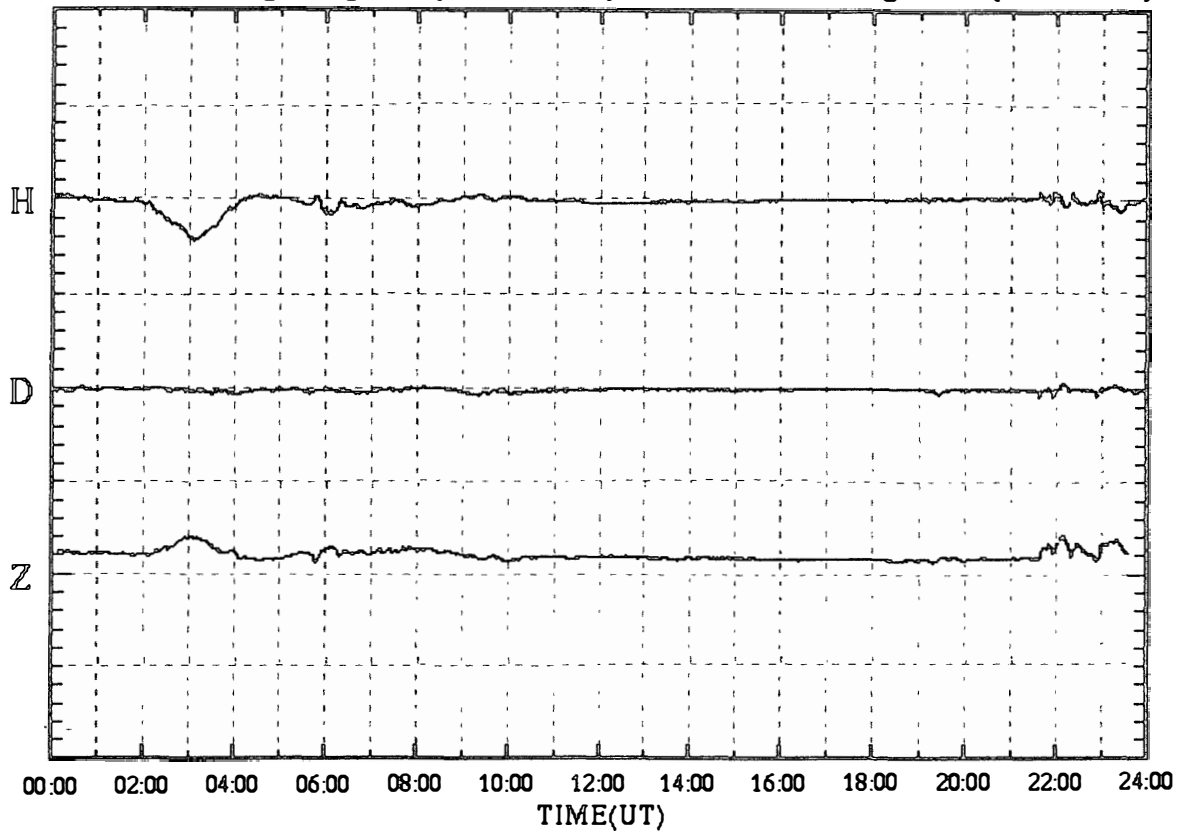

SYOWA magnetogram (100 nT/div)

18 Aug.2000 (DAY:231)

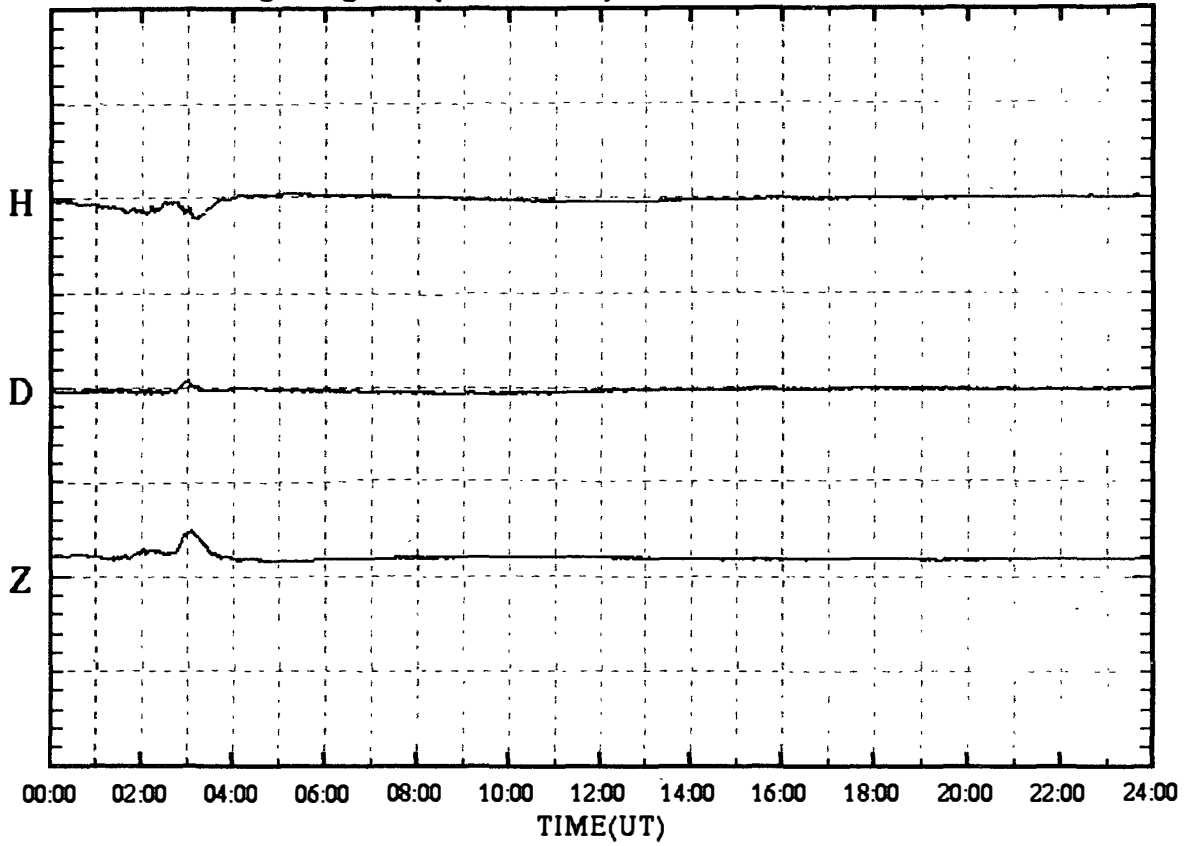

SYOWA magnetogram (100 nT/div)

19 Aug.2000 (DAY:232)

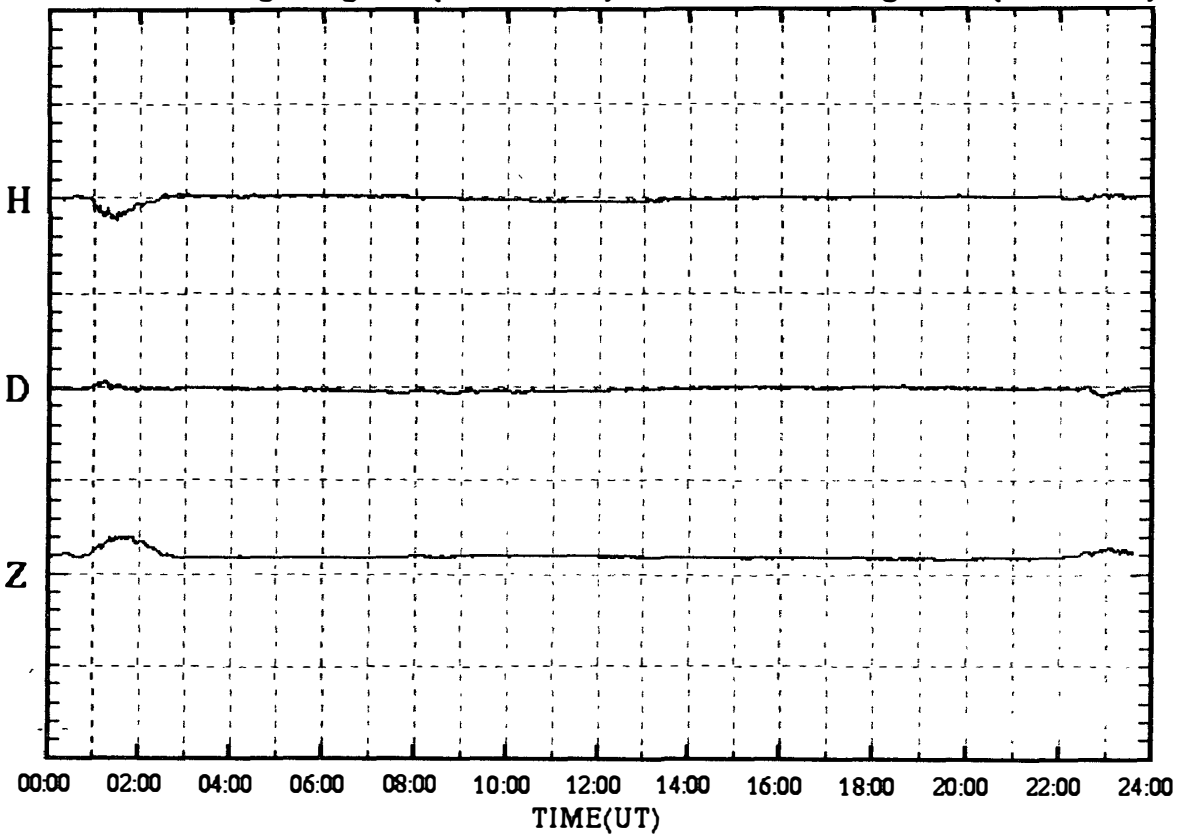

SYOWA magnetogram (100 nT/div)

20 Aug.2000 (DAY:233)

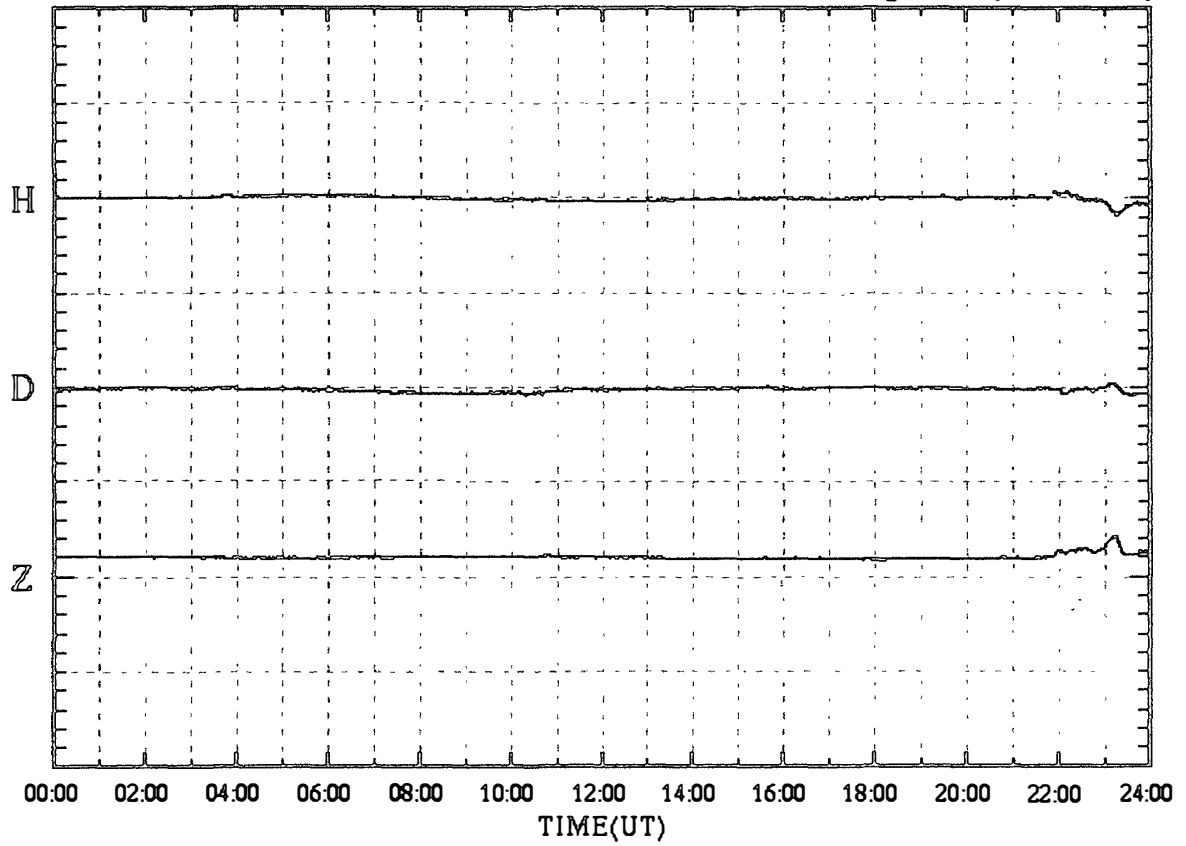

SYOWA magnetogram (100 nT/div)

21 Aug.2000 (DAY:234)

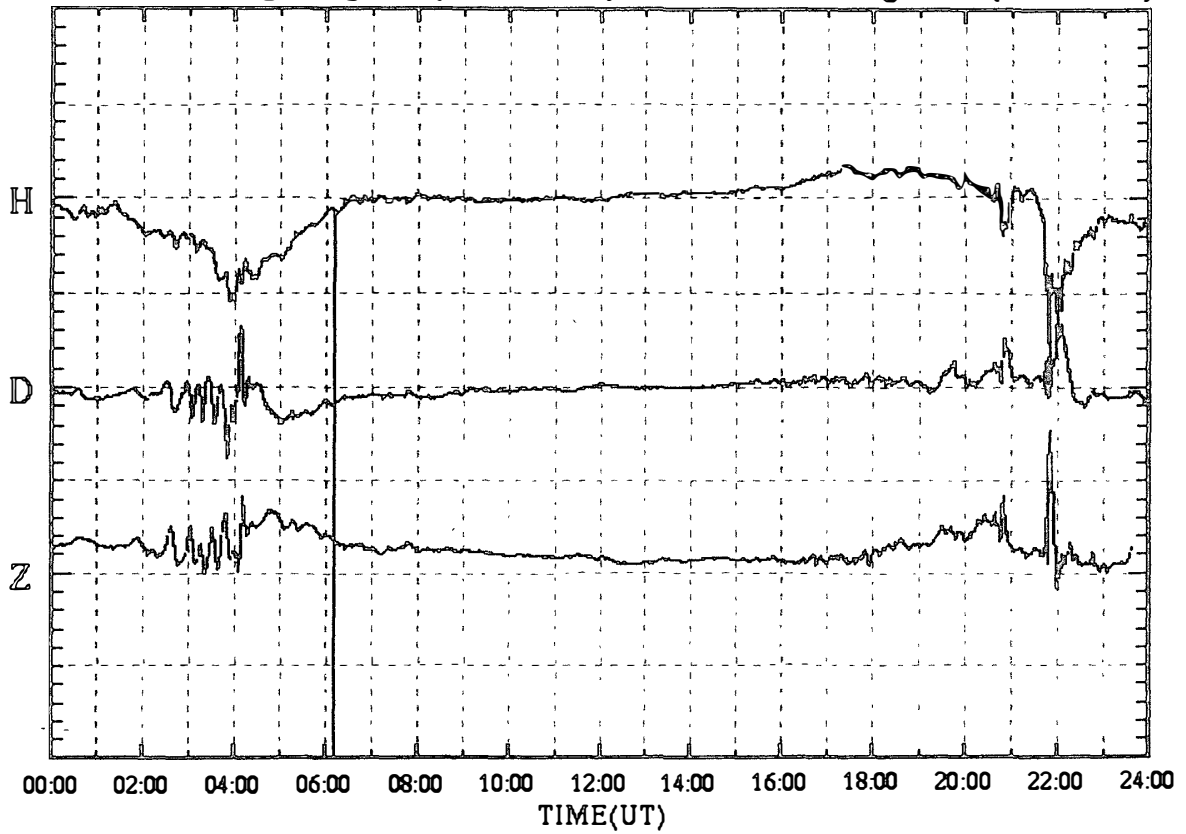

SYOWA magnetogram (100 nT/div)

22 Aug.2000 (DAY:235)

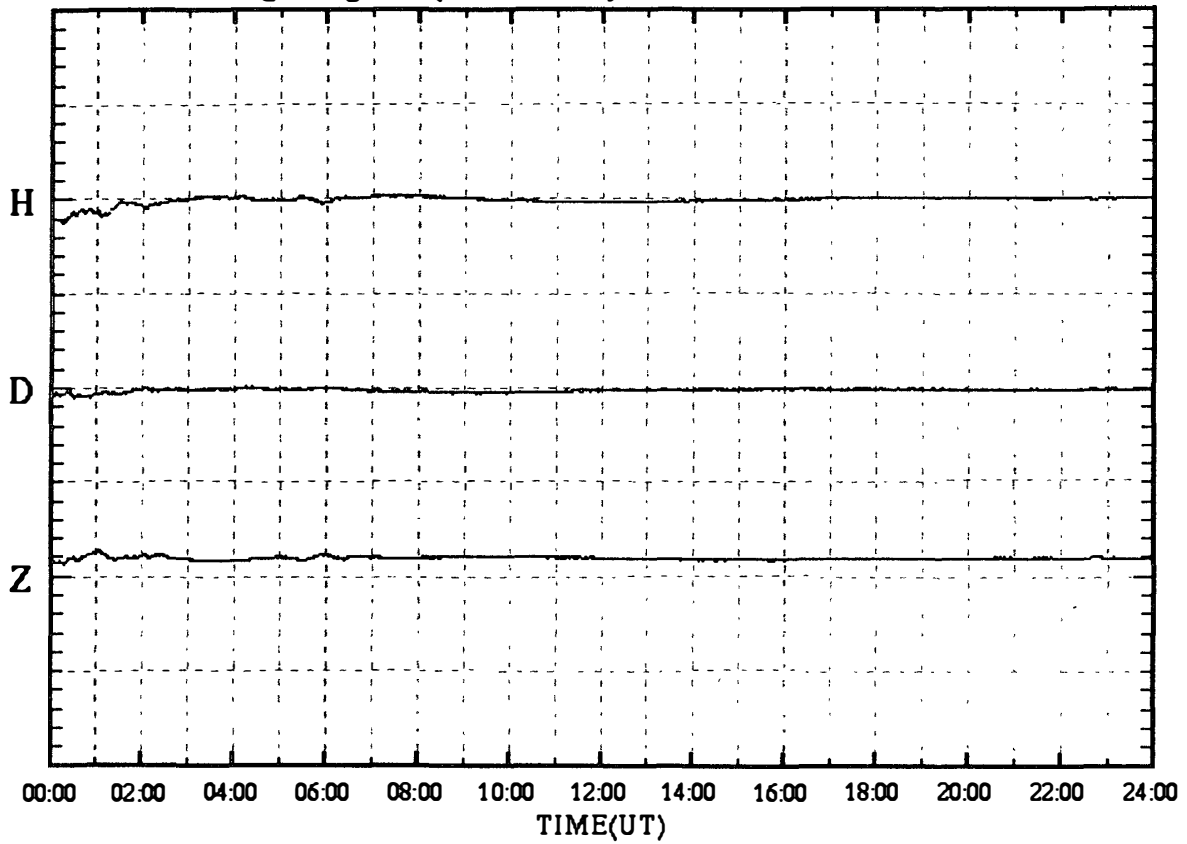

SYOWA magnetogram (100 nT/div)

23 Aug.2000 (DAY:236)

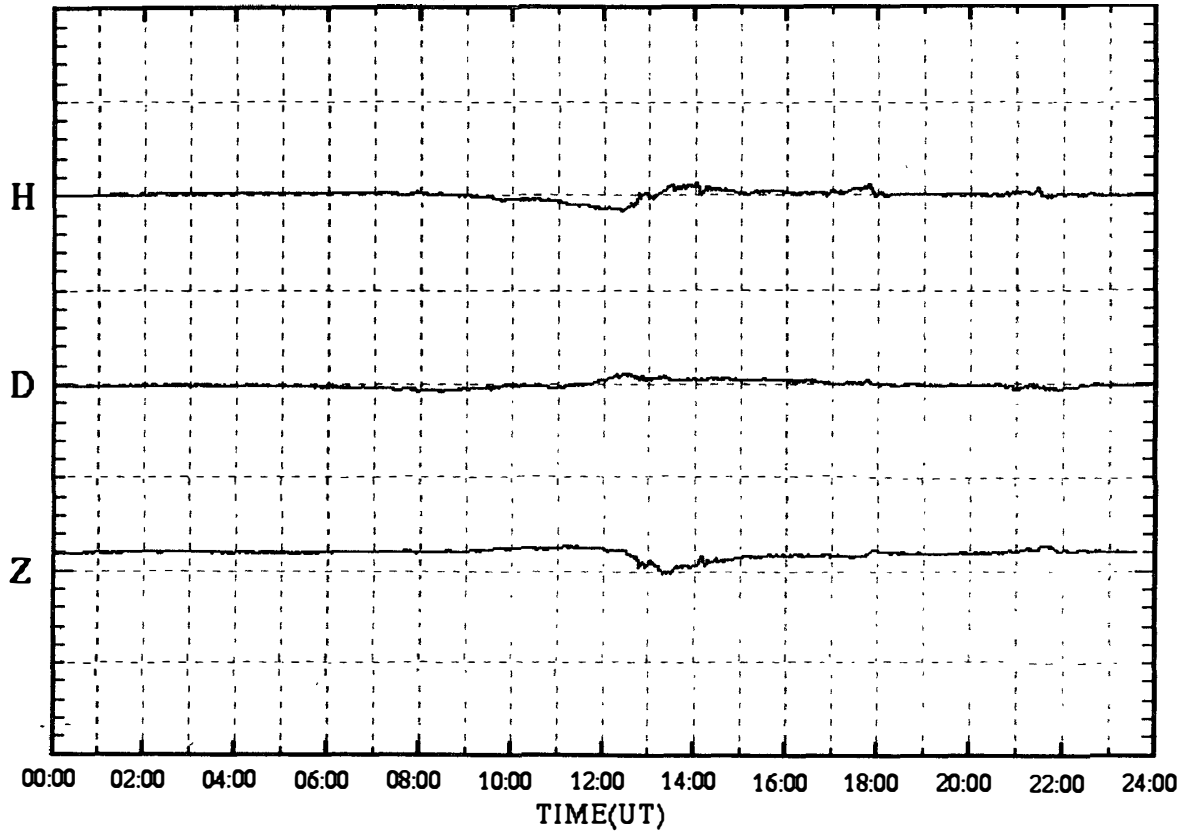

SYOWA magnetogram (100 nT/div)

24 Aug.2000 (DAY:237)

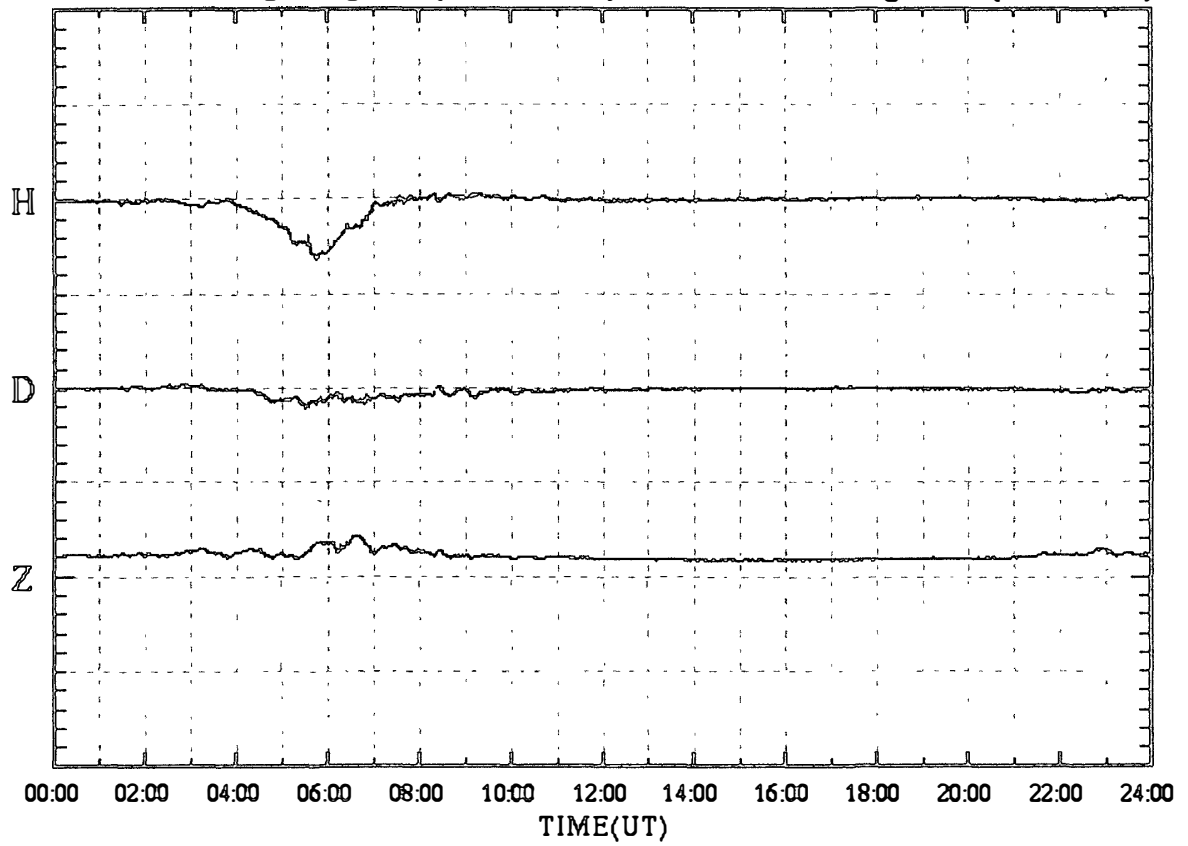

SYOWA magnetogram (100 nT/div)

25 Aug.2000 (DAY:238)

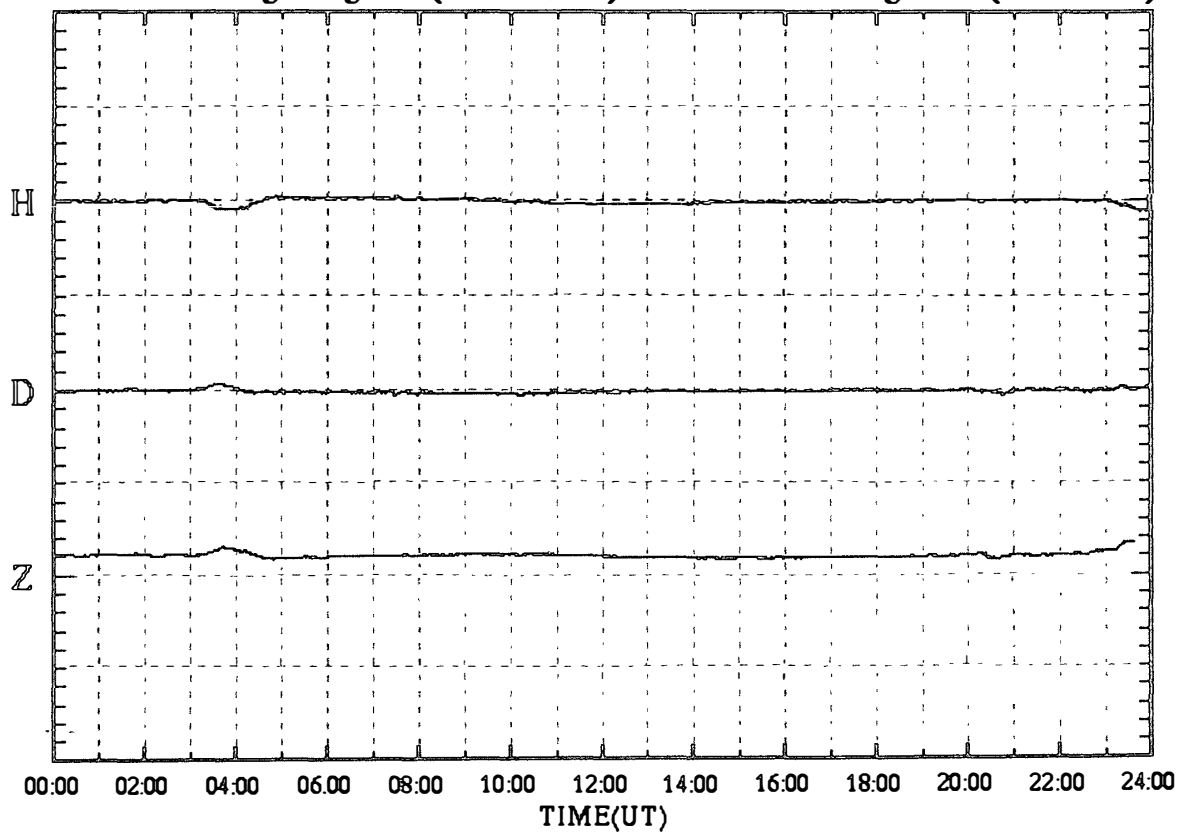

SYOWA magnetogram (100 nT/div)

26 Aug.2000 (DAY:239)

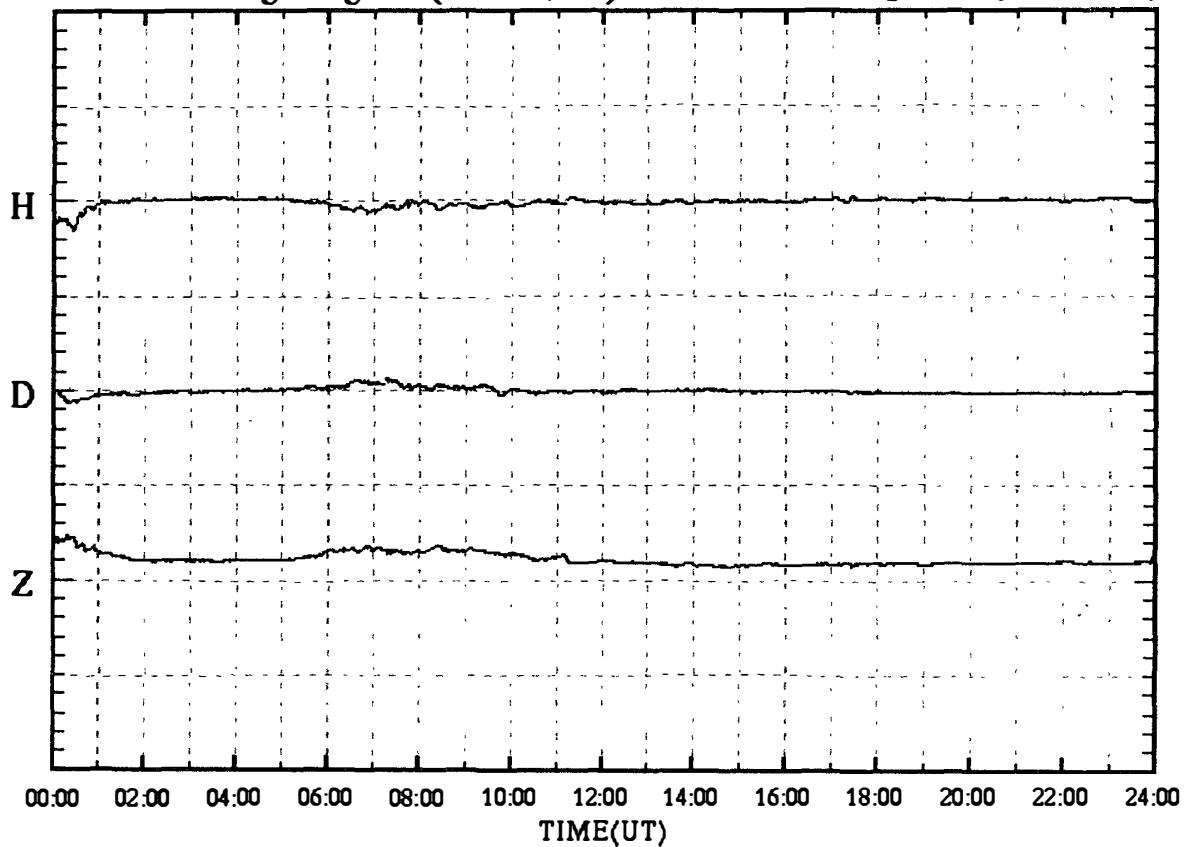

SYOWA magnetogram (100 nT/div)

27 Aug.2000 (DAY:240)

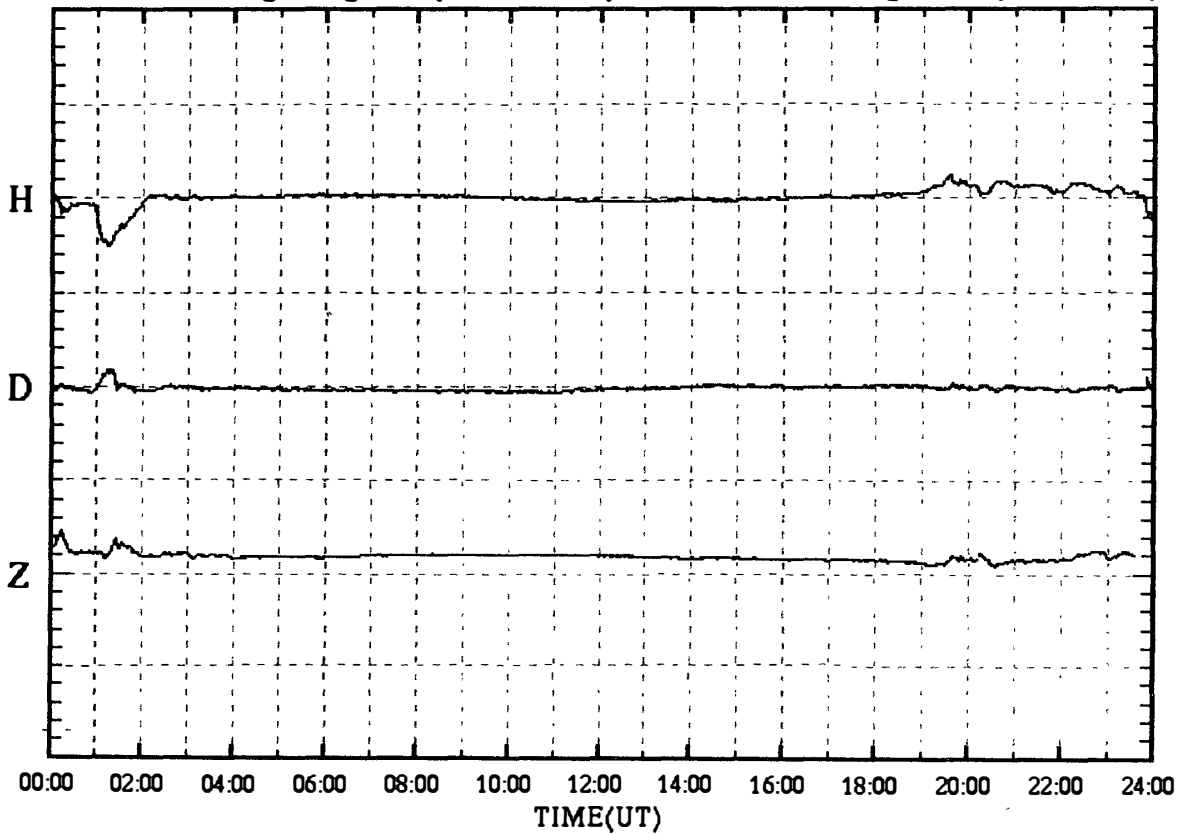

SYOWA magnetogram (100 nT/div)

28 Aug.2000 (DAY:241)

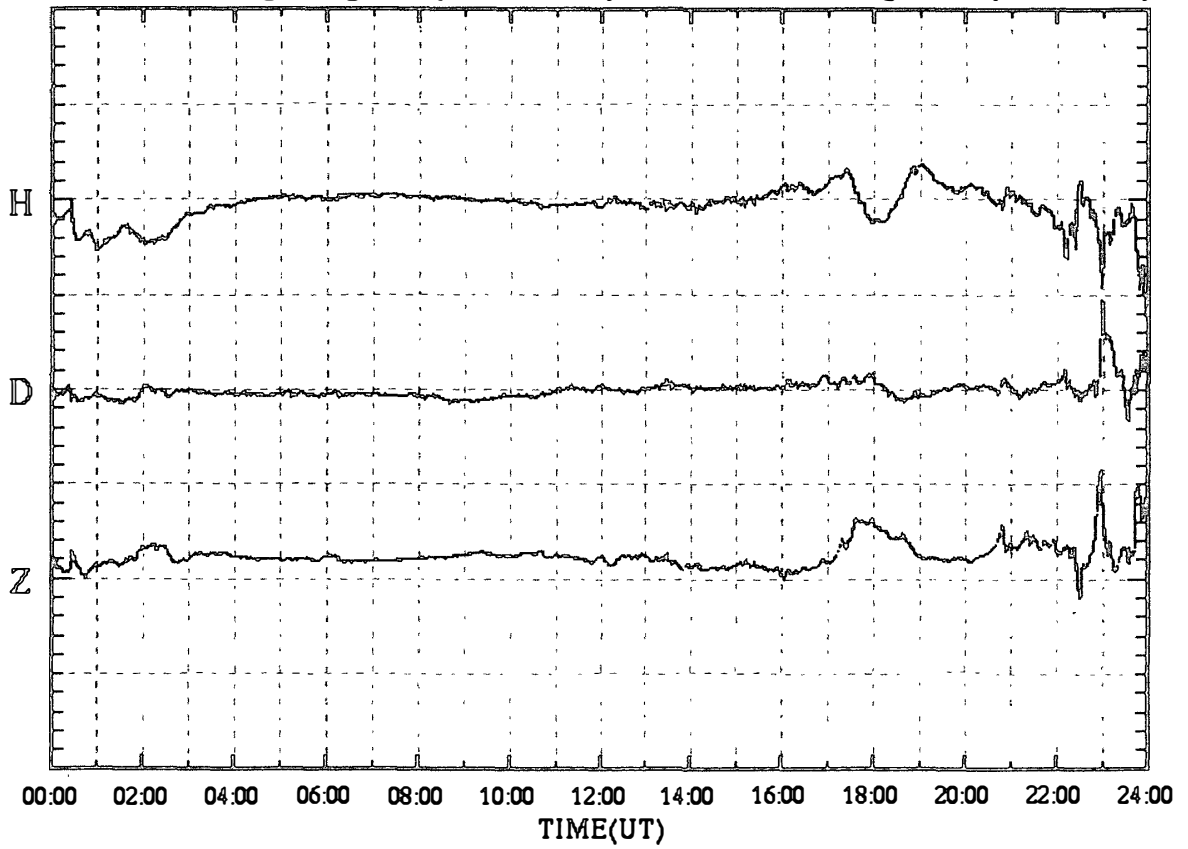

SYOWA magnetogram (100 nT/div)

29 Aug.2000 (DAY:242)

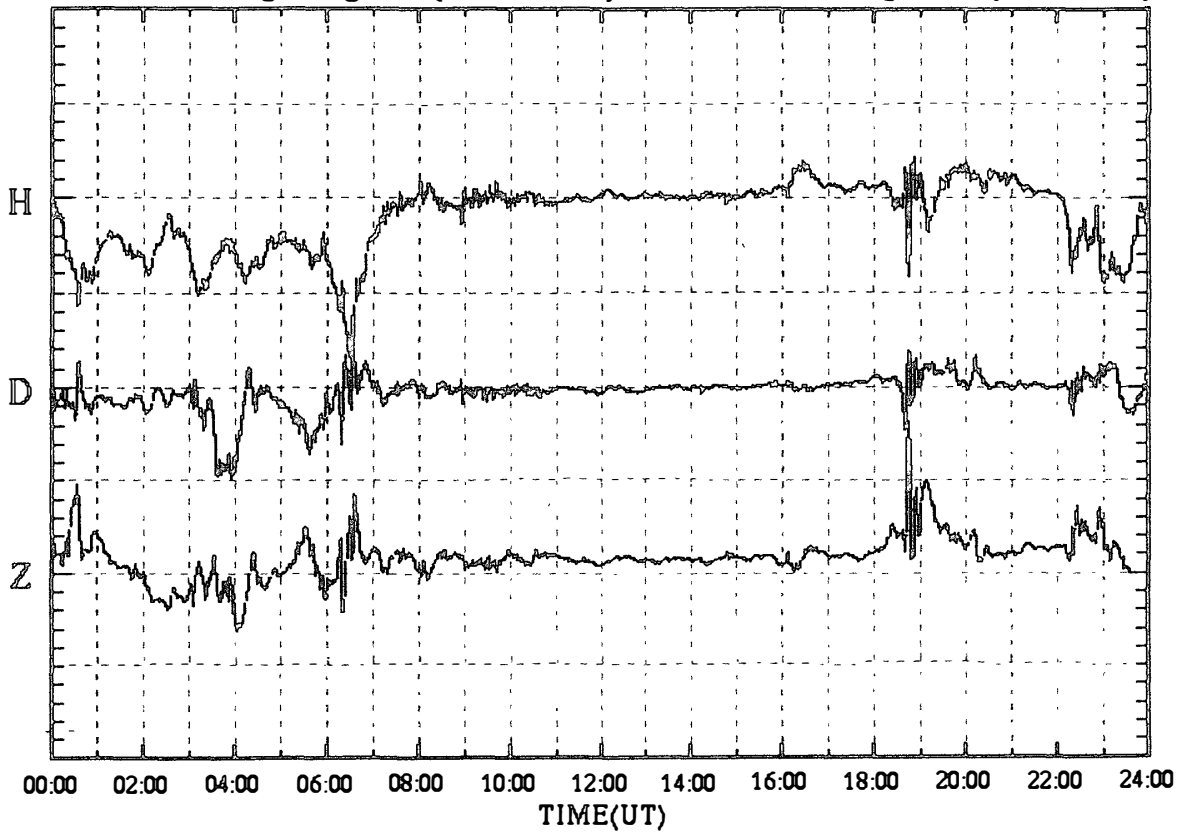

SYOWA magnetogram (100 nT/div)

30 Aug.2000 (DAY:243)

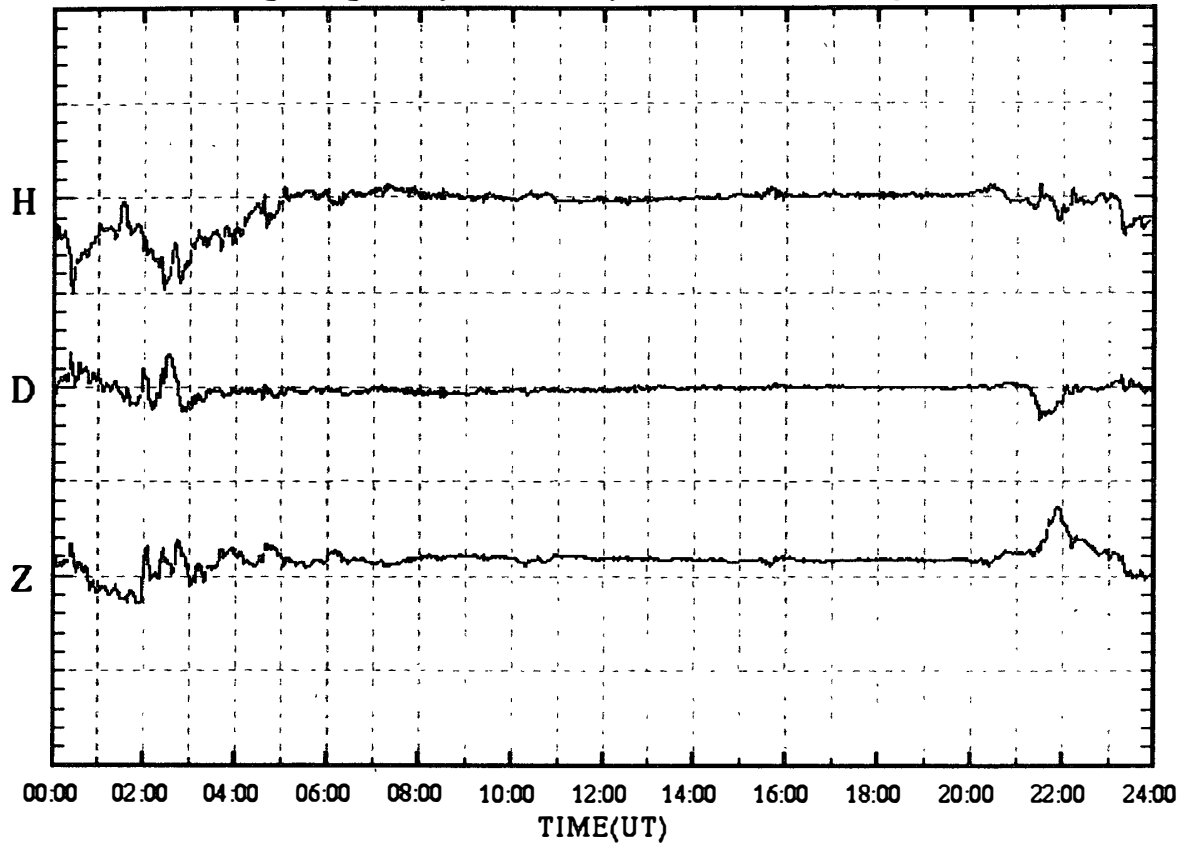

SYOWA magnetogram (100 nT/div)

31 Aug.2000 (DAY:244)

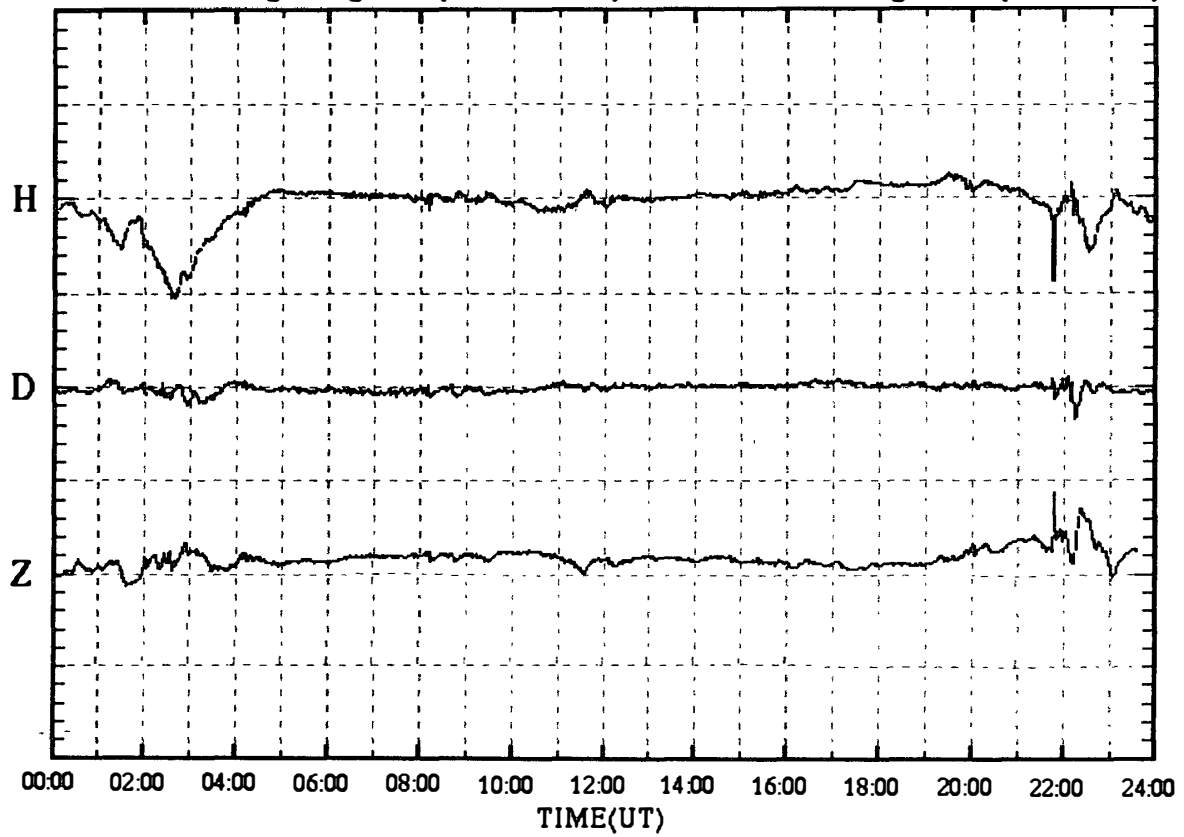

SYOWA magnetogram (100 nT/div)

01 Sep.2000 (DAY:245)

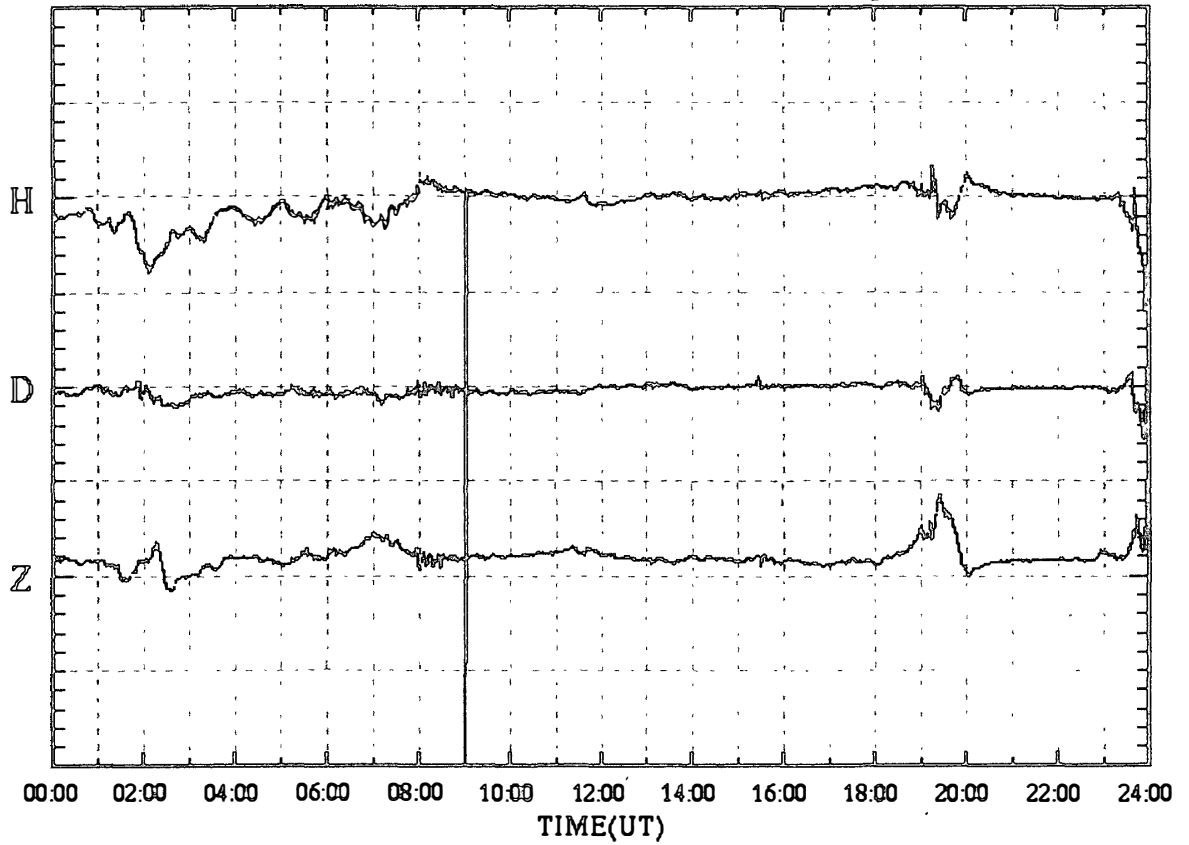

SYOWA magnetogram (100 nT/div)

02 Sep.2000 (DAY:246)

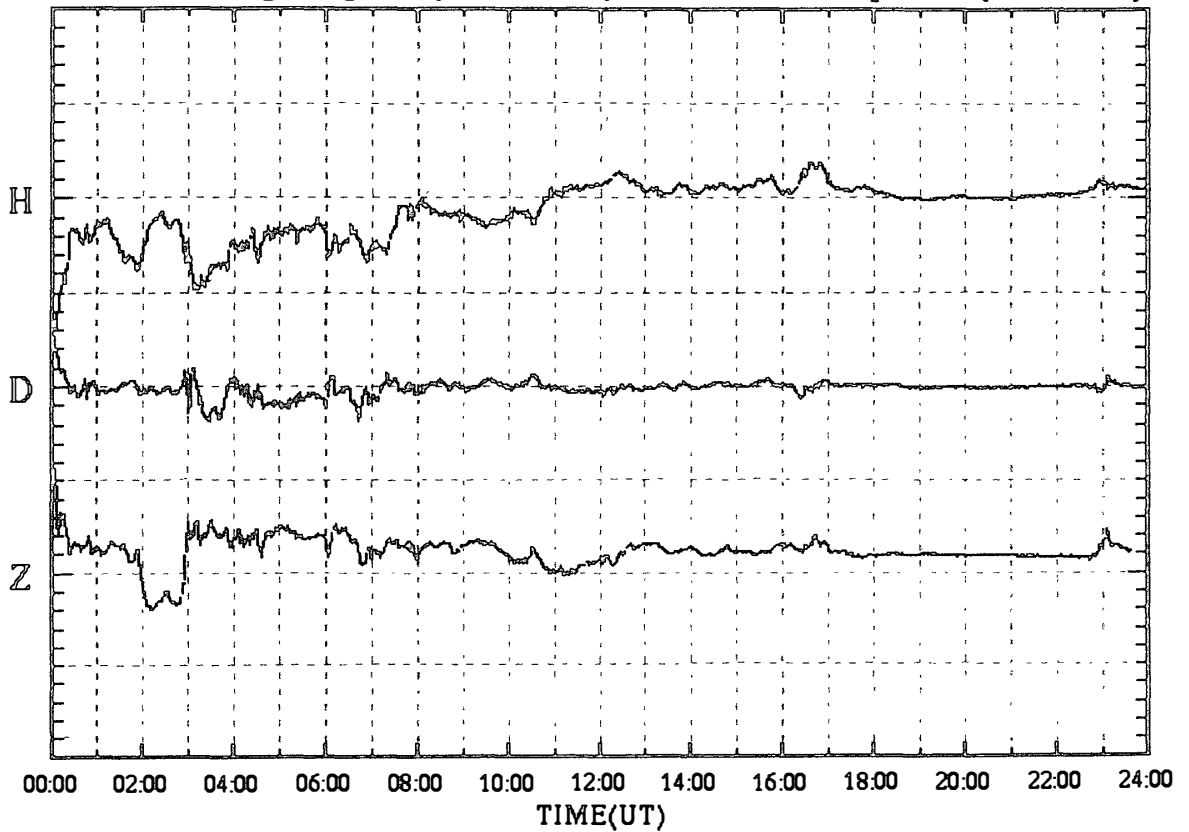

SYOWA magnetogram (100 nT/div)

03 Sep.2000 (DAY:247)

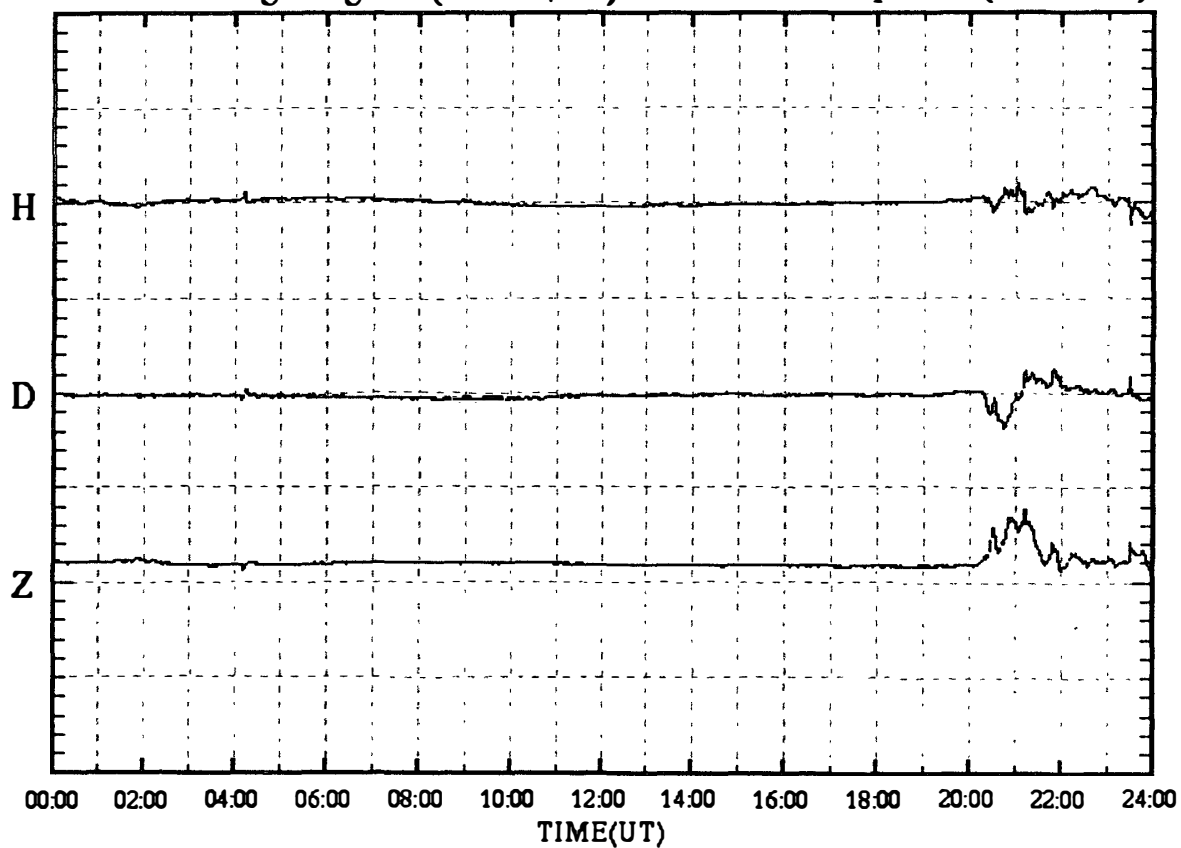

SYOWA magnetogram (100 nT/div)

04 Sep.2000 (DAY:248)

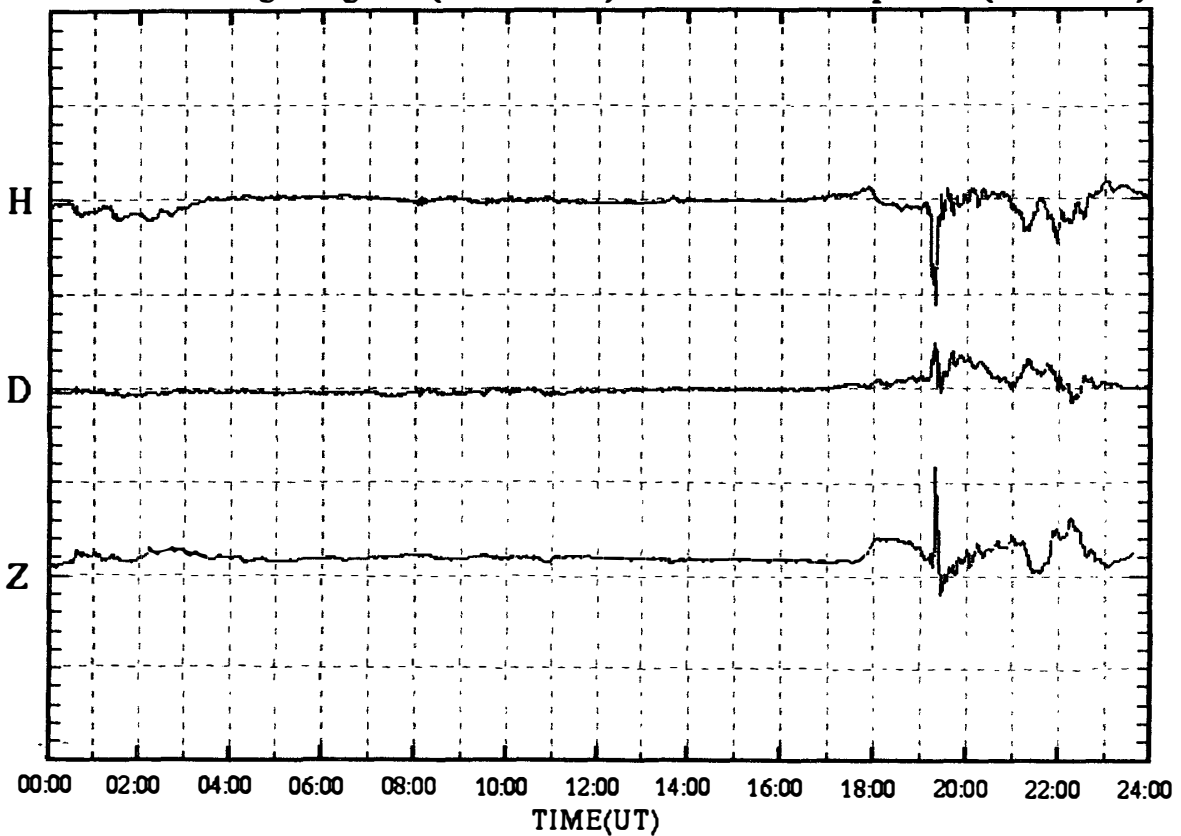

SYOWA magnetogram (100 nT/div)

05 Sep.2000 (DAY:249)

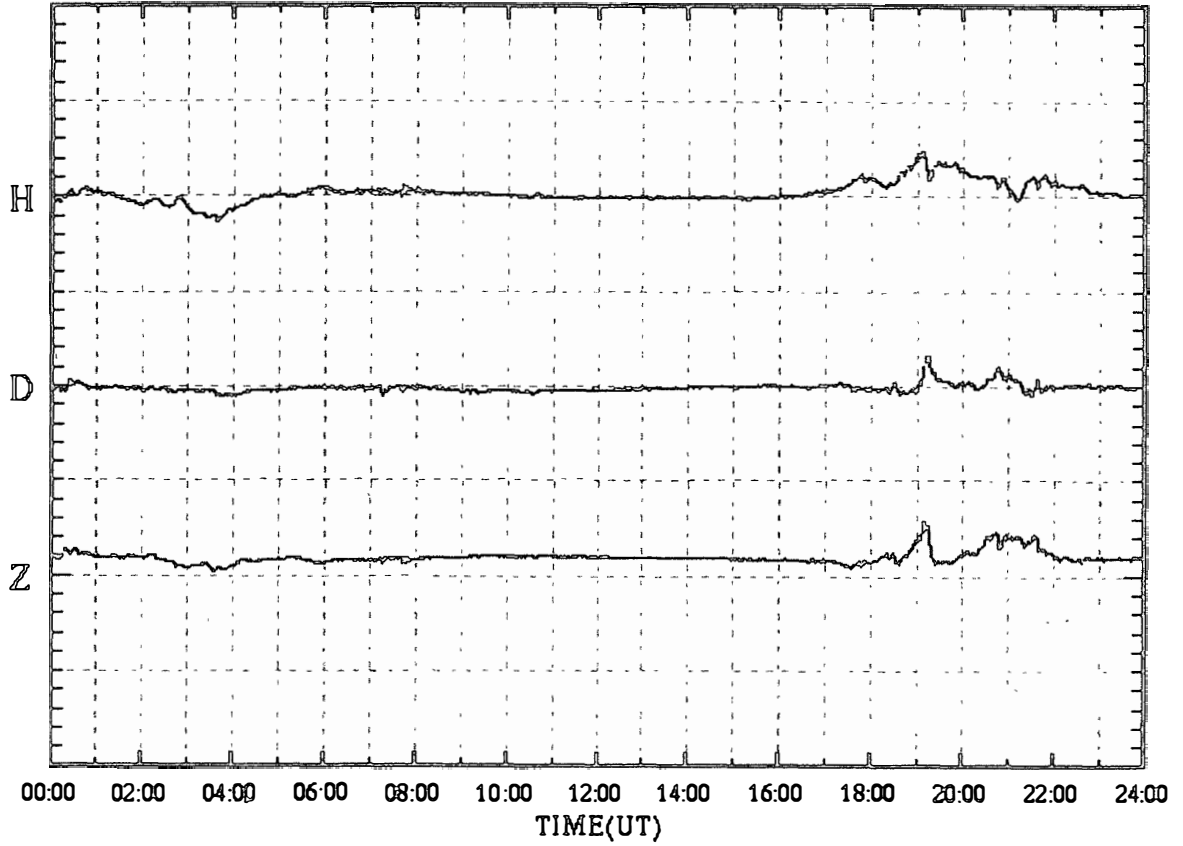

SYOWA magnetogram (100 nT/div)

06 Sep.2000 (DAY:250)

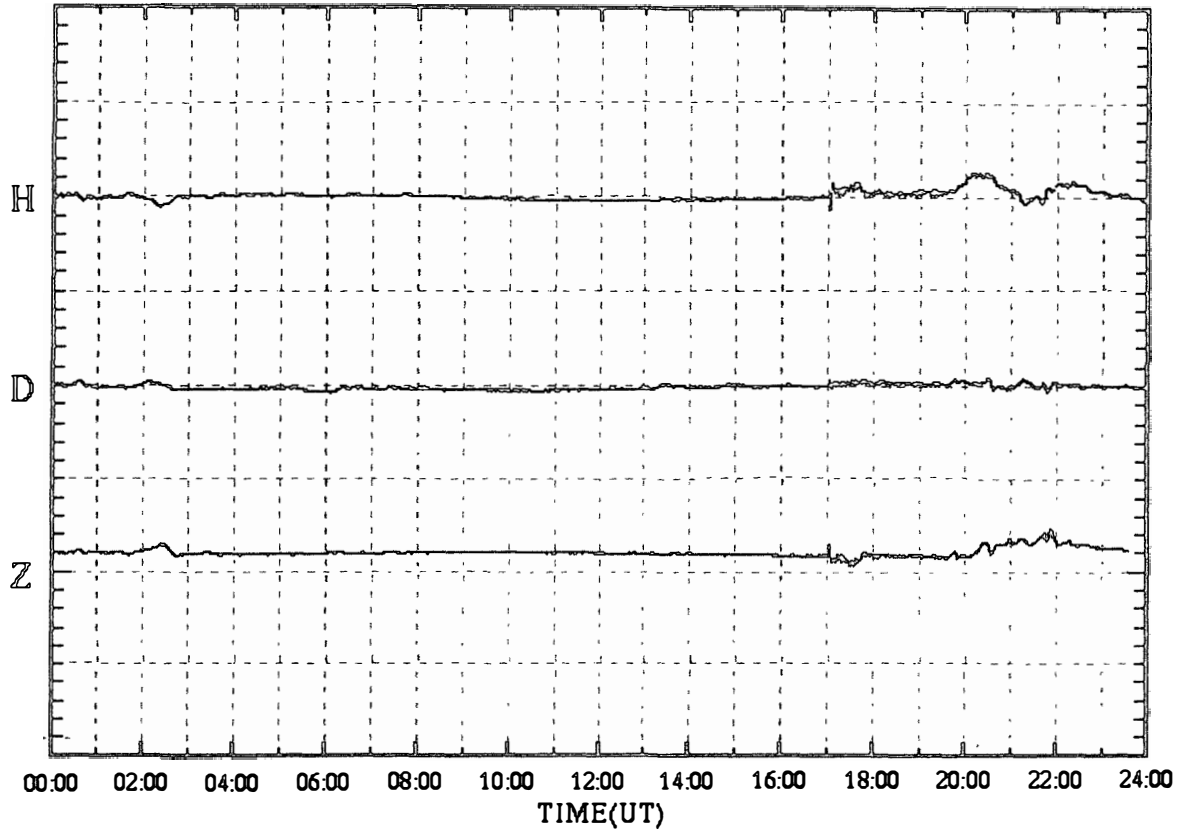

SYOWA magnetogram (100 nT/div)

07 Sep.2000 (DAY:251)

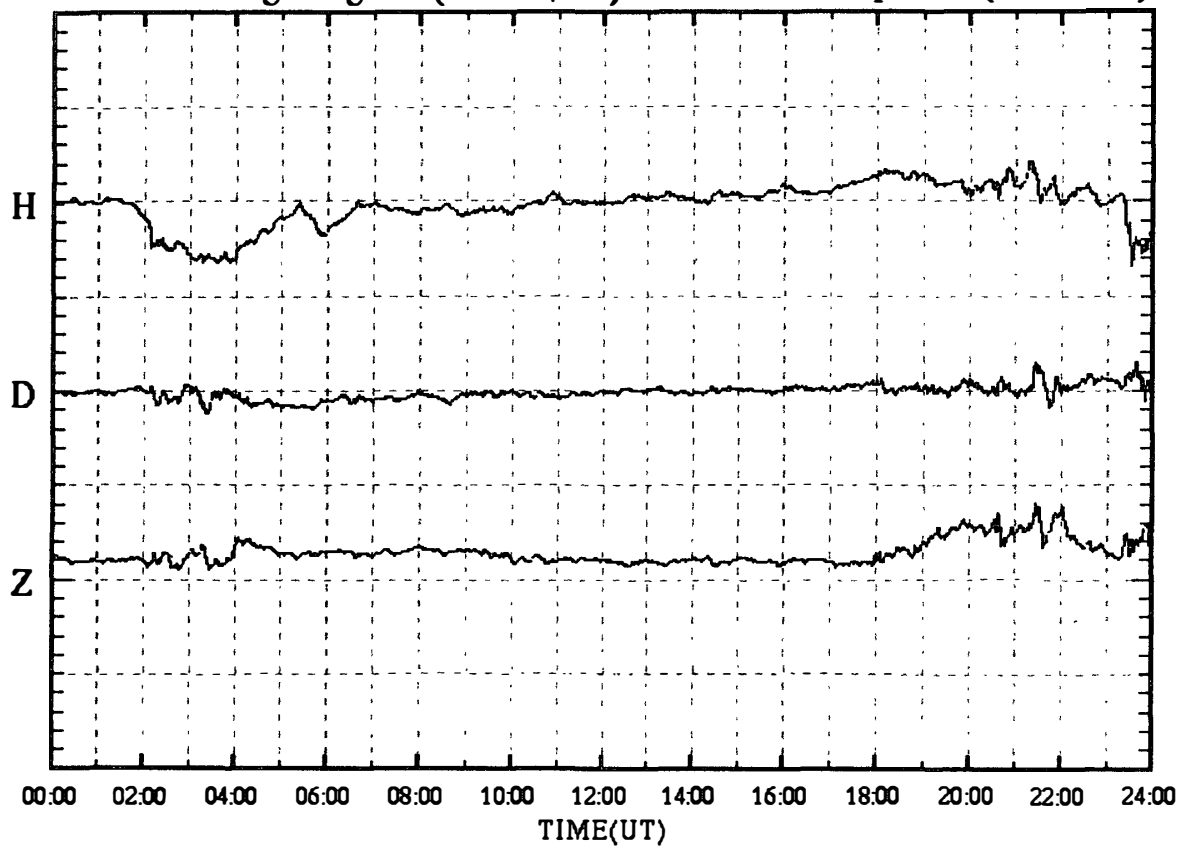

SYOWA magnetogram (100 nT/div)

08 Sep.2000 (DAY:252)

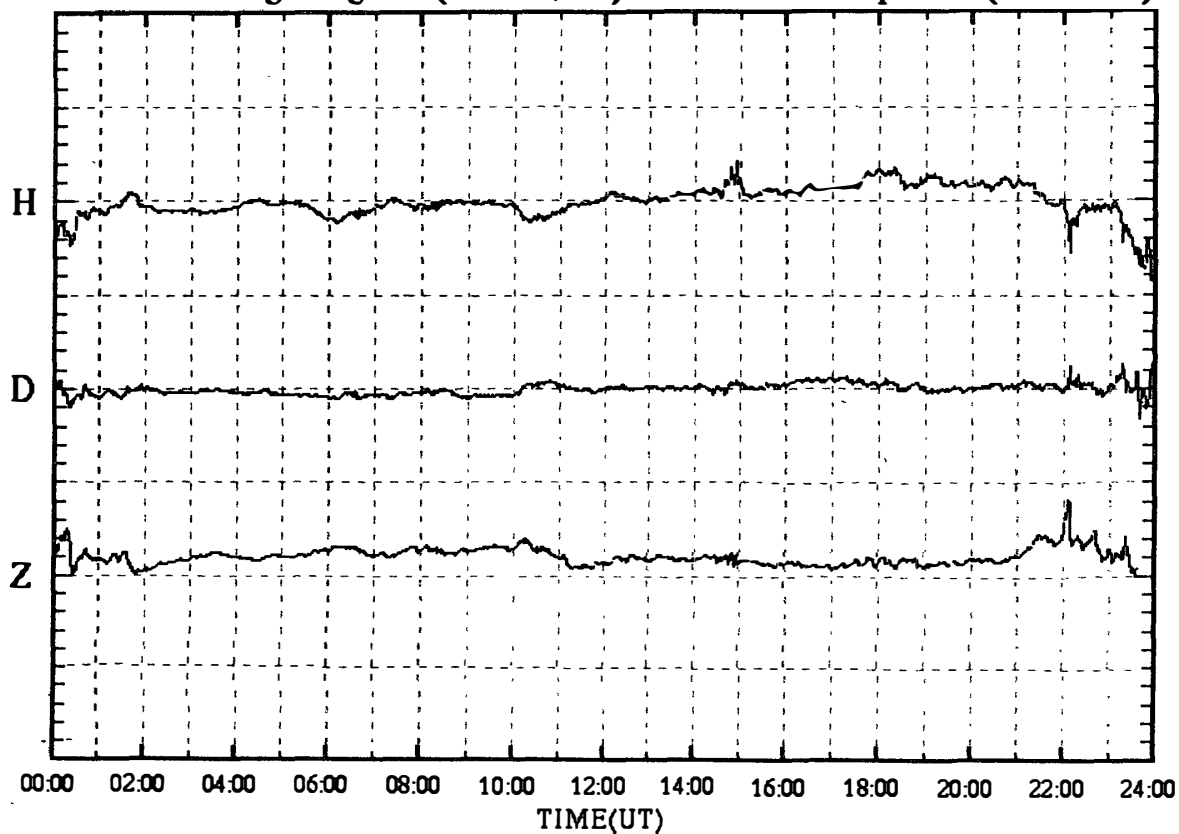

SYOWA magnetogram (100 nT/div)

09 Sep.2000 (DAY:253)

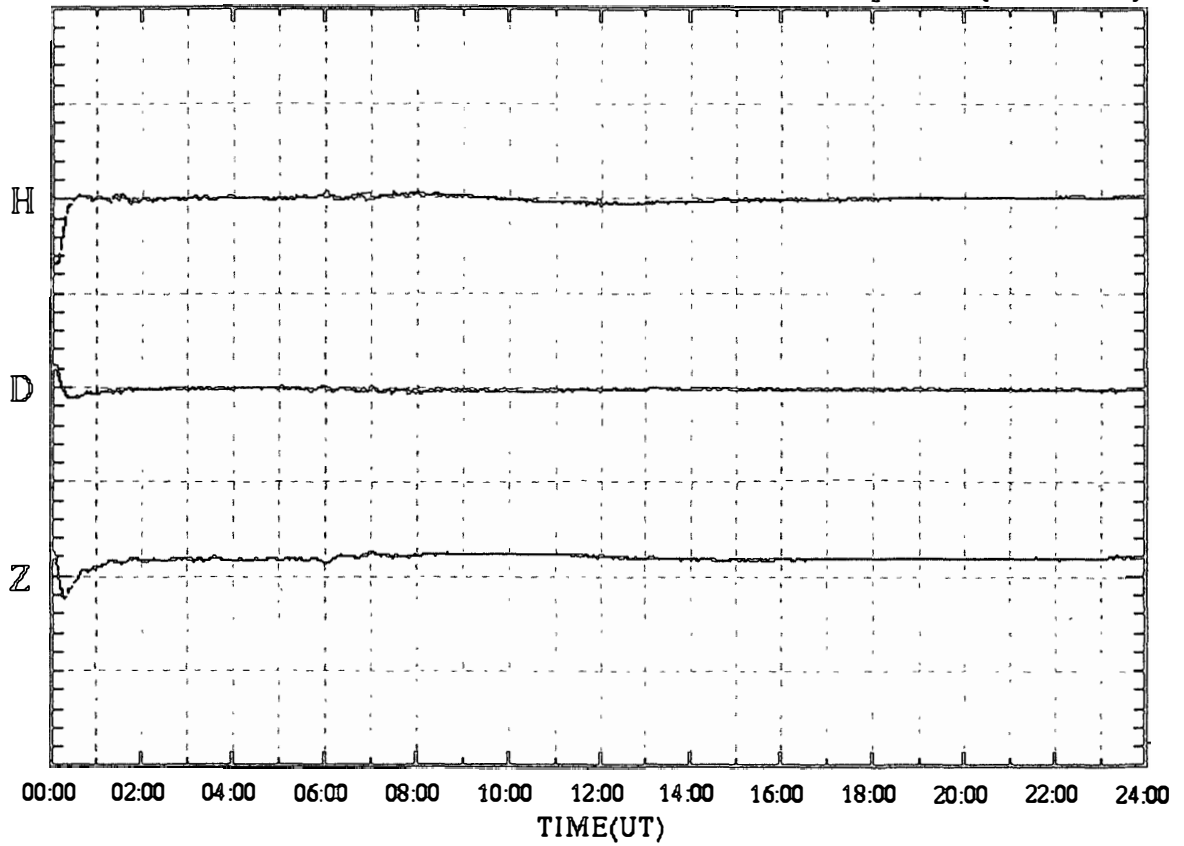

SYOWA magnetogram (100 nT/div)

10 Sep.2000 (DAY:254)

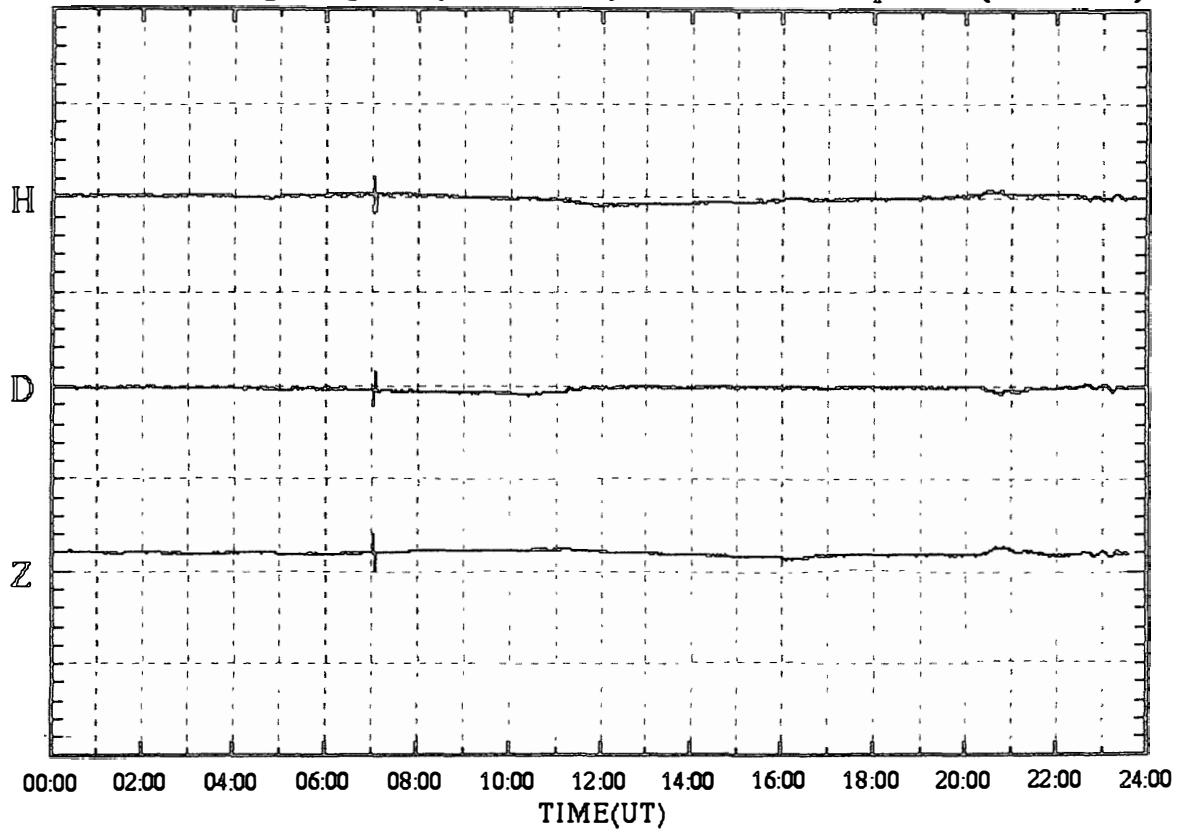

SYOWA magnetogram (100 nT/div)

11 Sep.2000 (DAY:255)

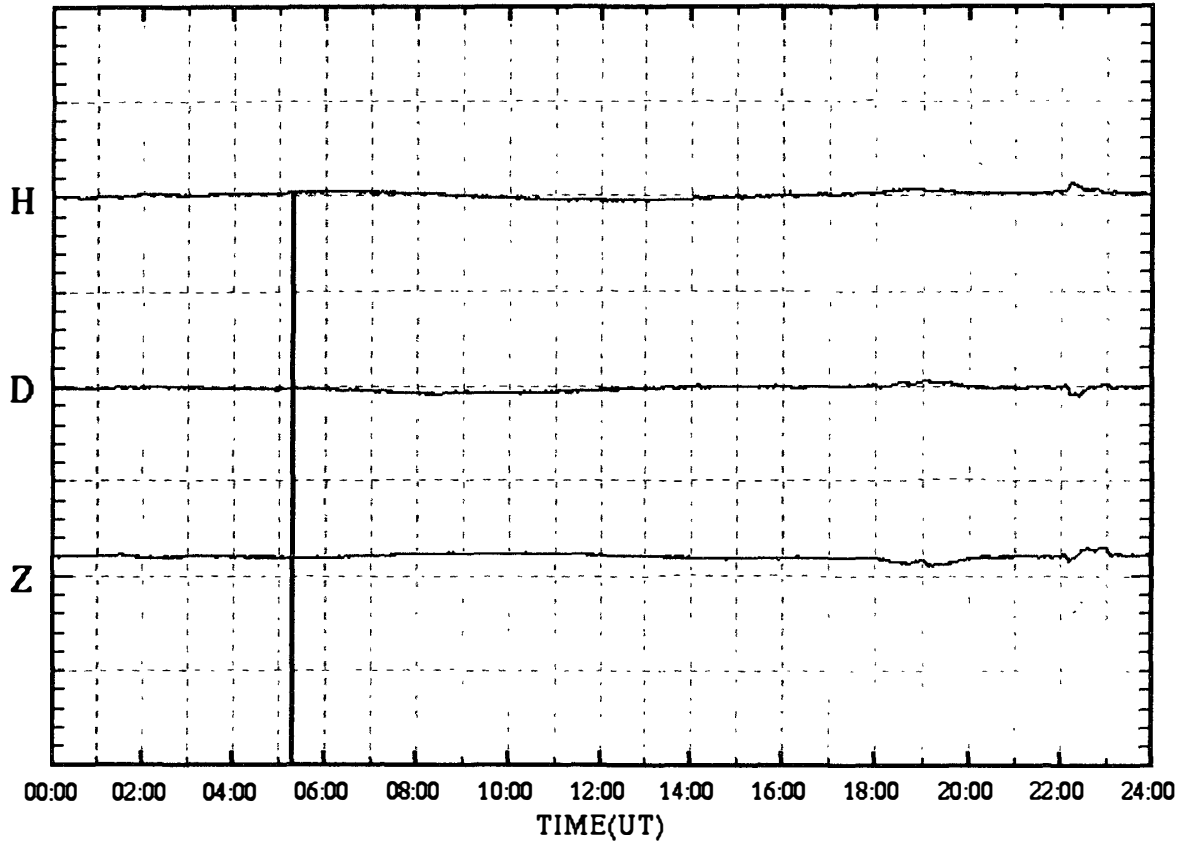

SYOWA magnetogram (100 nT/div)

12 Sep.2000 (DAY:256)

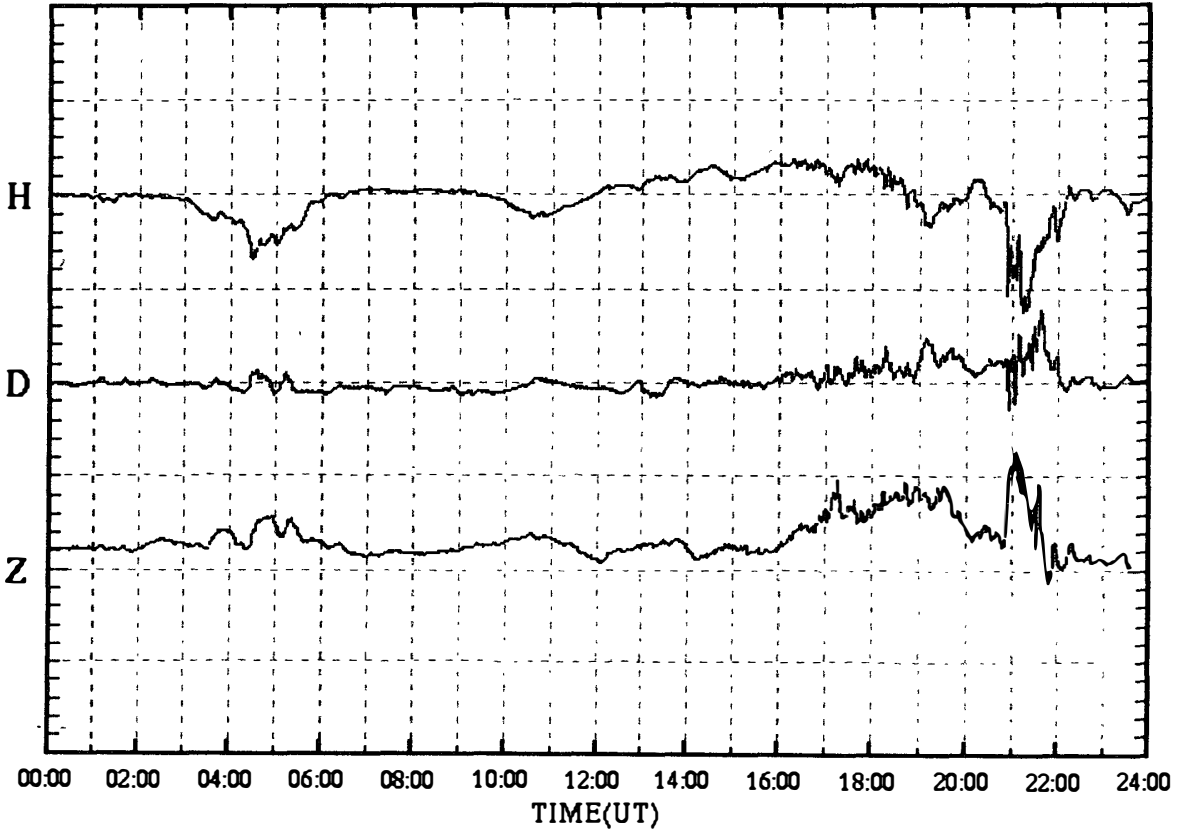

SYOWA magnetogram (100 nT/div)

13 Sep.2000 (DAY:257)

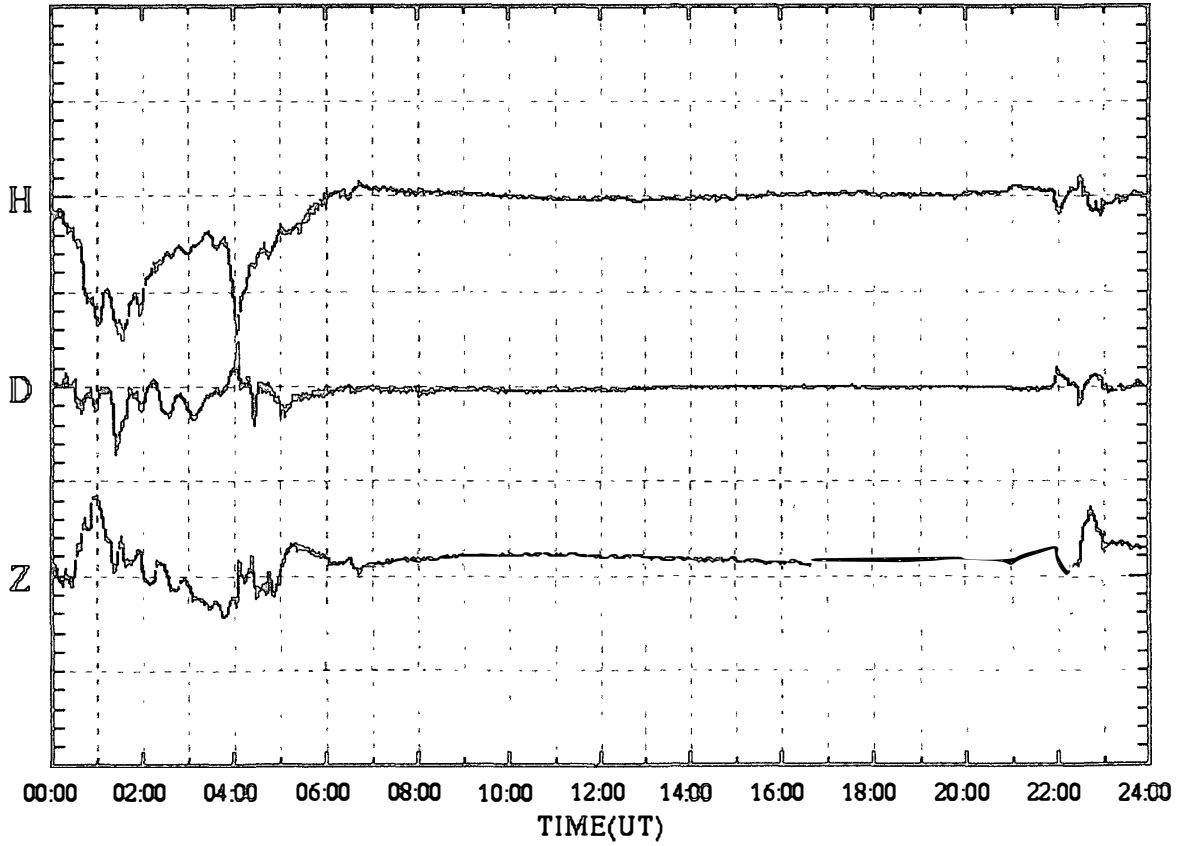

SYOWA magnetogram (100 nT/div)

14 Sep.2000 (DAY:258)

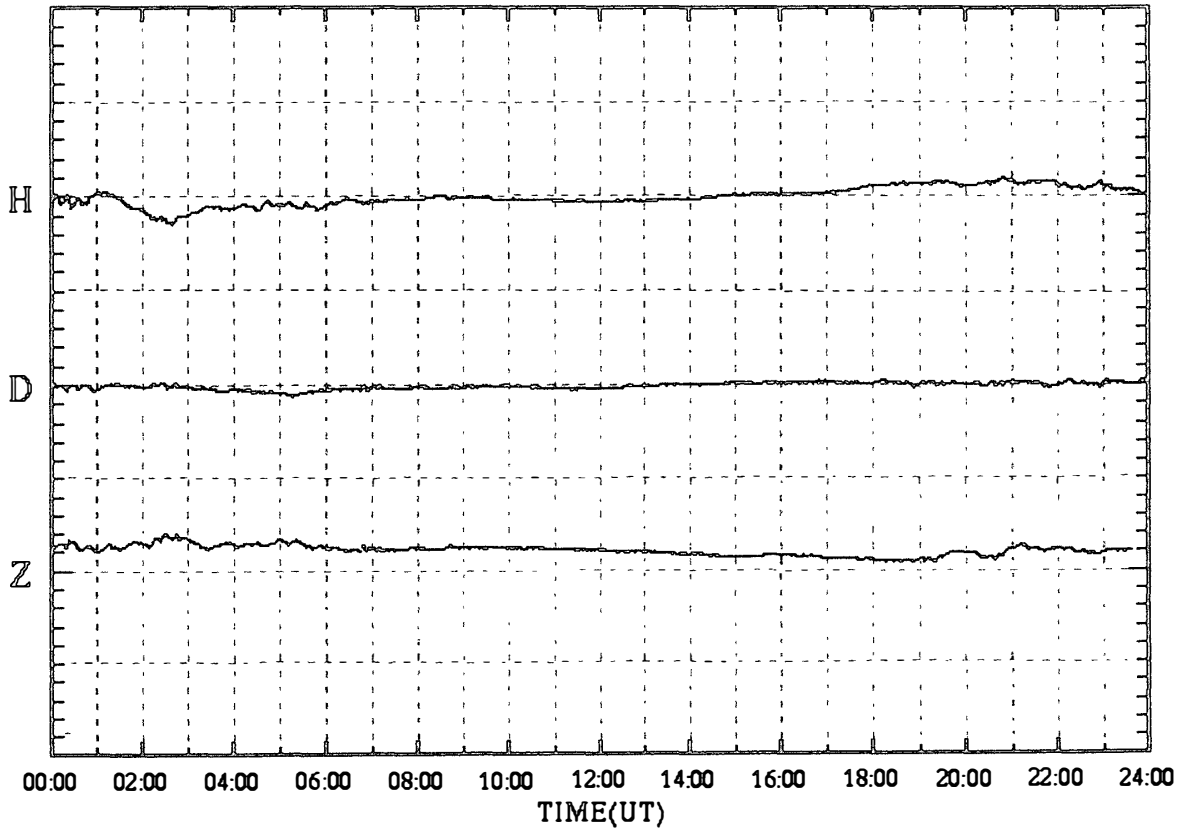

SYOWA magnetogram (100 nT/div)

15 Sep.2000 (DAY:259)

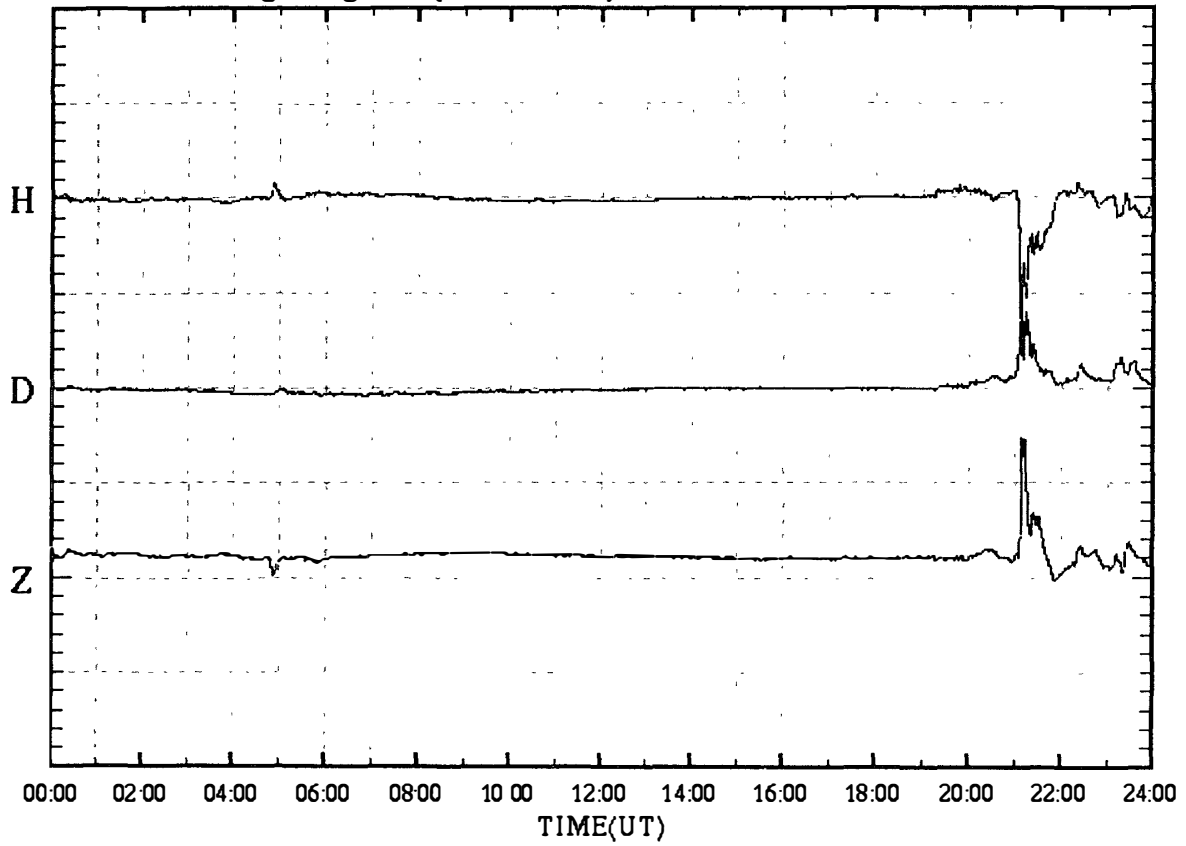

SYOWA magnetogram (100 nT/div)

16 Sep.2000 (DAY:260)

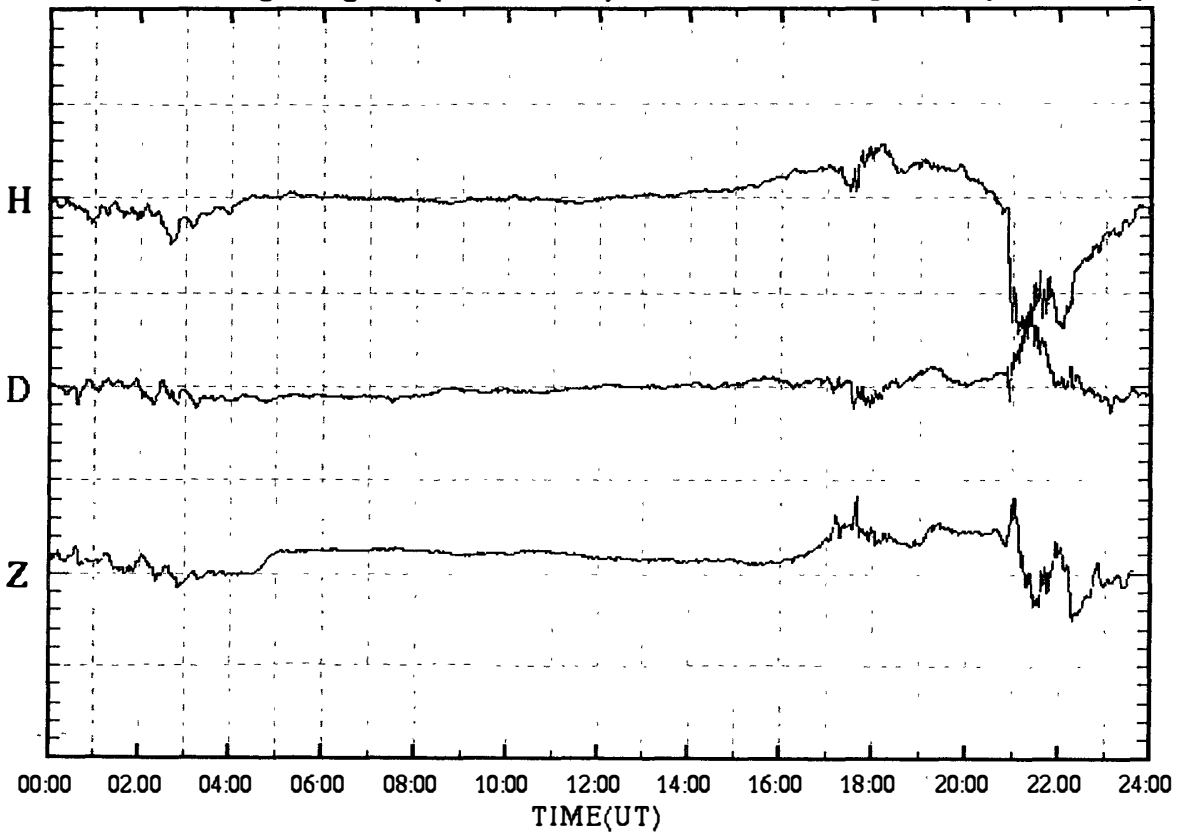

SYOWA magnetogram (100 nT/div)

17 Sep.2000 (DAY:261)

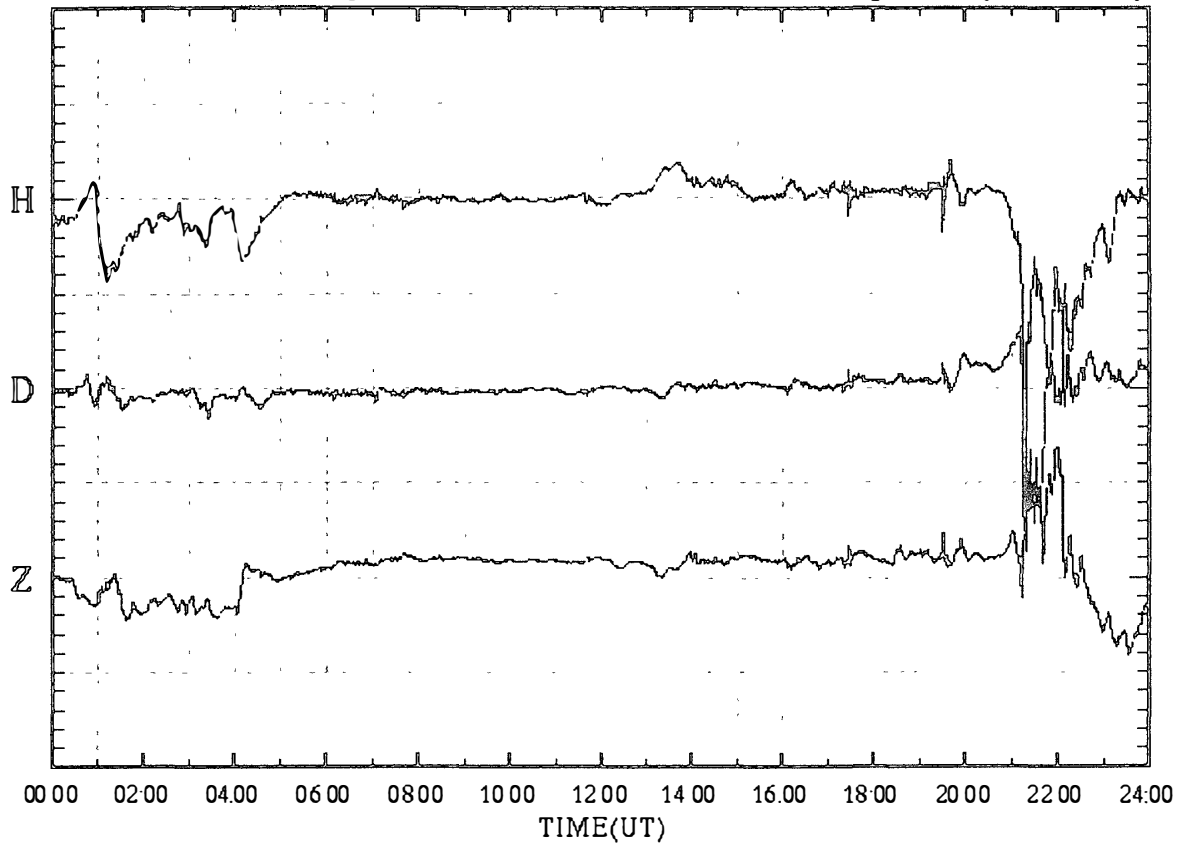

SYOWA magnetogram (100 nT/div)

18 Sep.2000 (DAY:262)

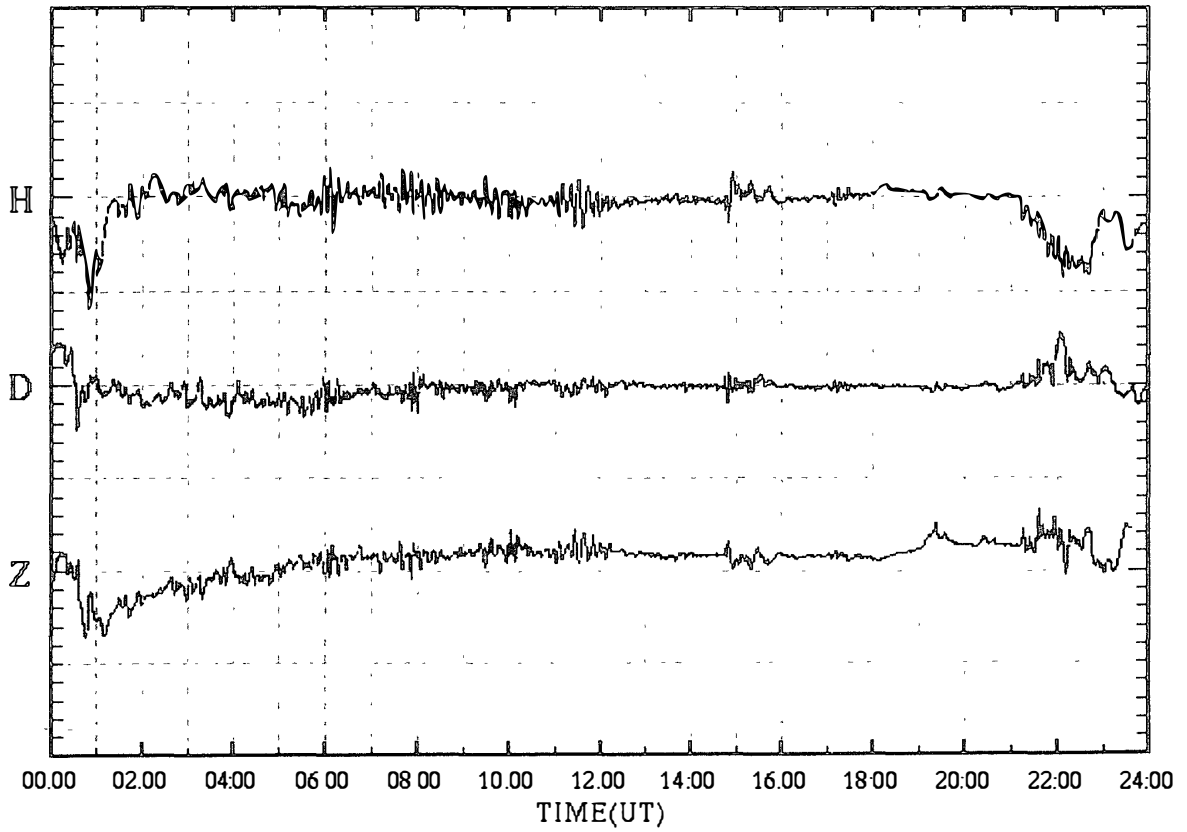

SYOWA magnetogram (100 nT/div)

19 Sep.2000 (DAY:263)

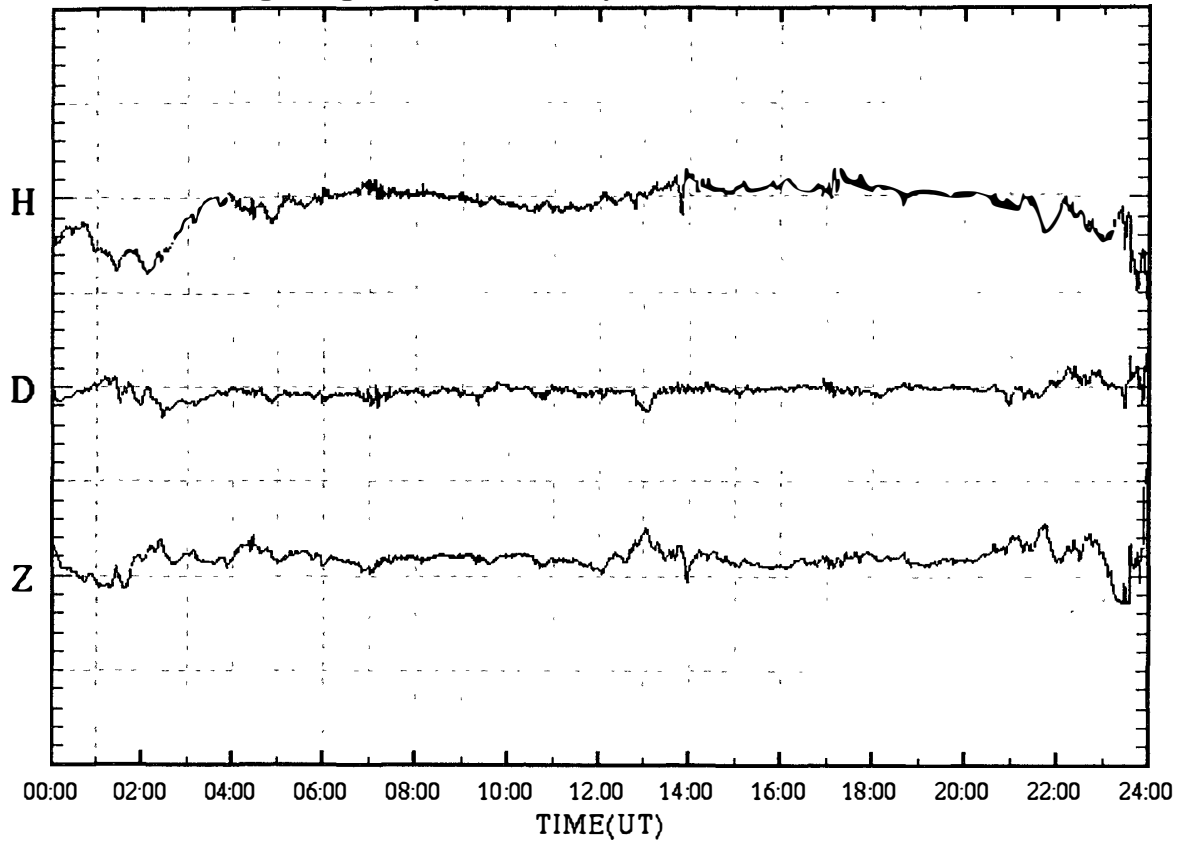

SYOWA magnetogram (100 nT/div)

20 Sep.2000 (DAY:264)

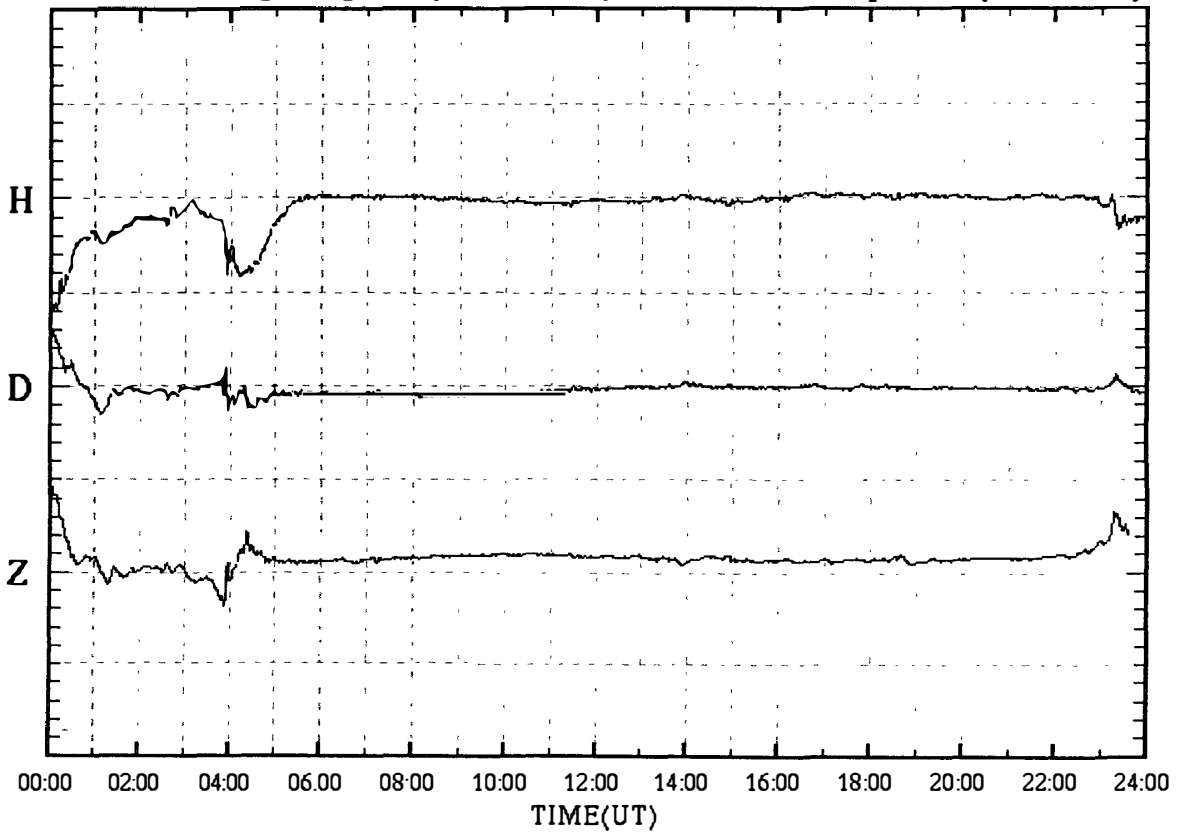

SYOWA magnetogram (100 nT/div)

21 Sep.2000 (DAY:265)

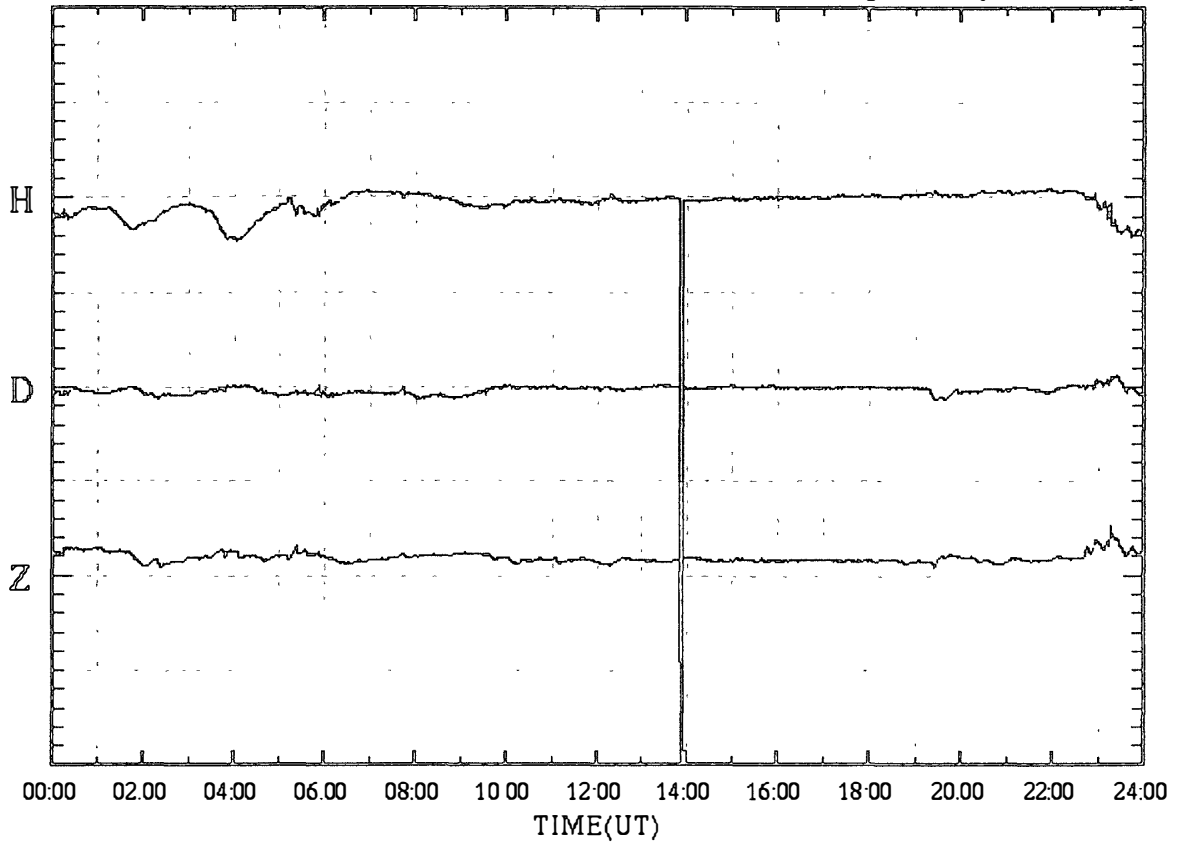

SYOWA magnetogram (100 nT/div)

22 Sep.2000 (DAY:266)

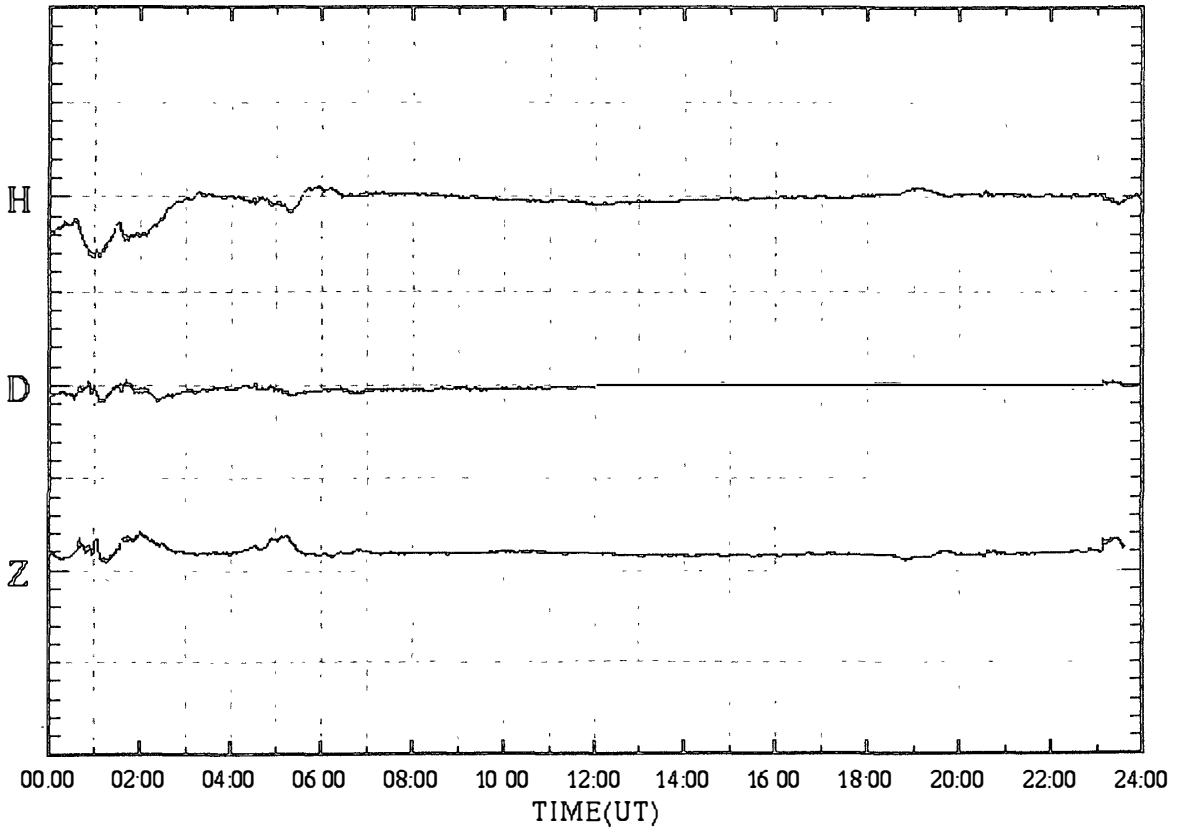

SYOWA magnetogram (100 nT/div)

23 Sep.2000 (DAY:267)

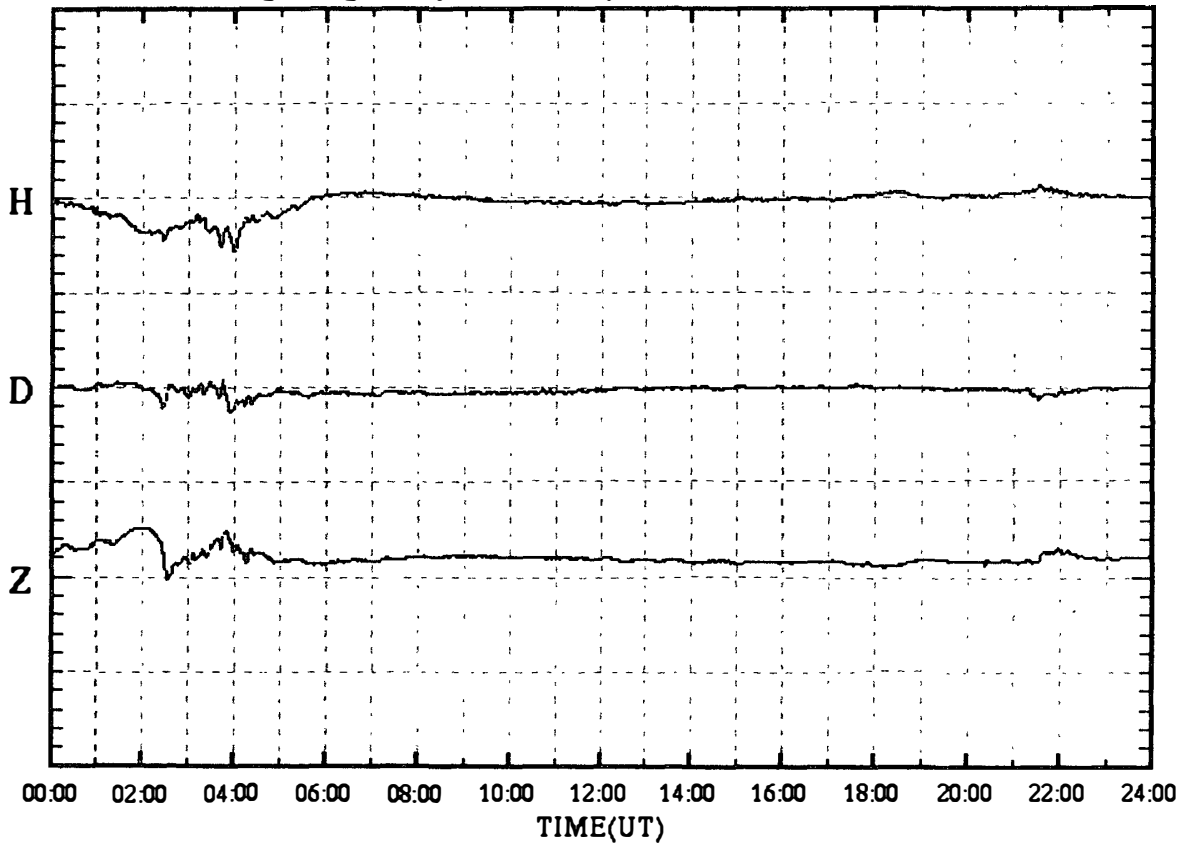

SYOWA magnetogram (100 nT/div)

24 Sep.2000 (DAY:268)

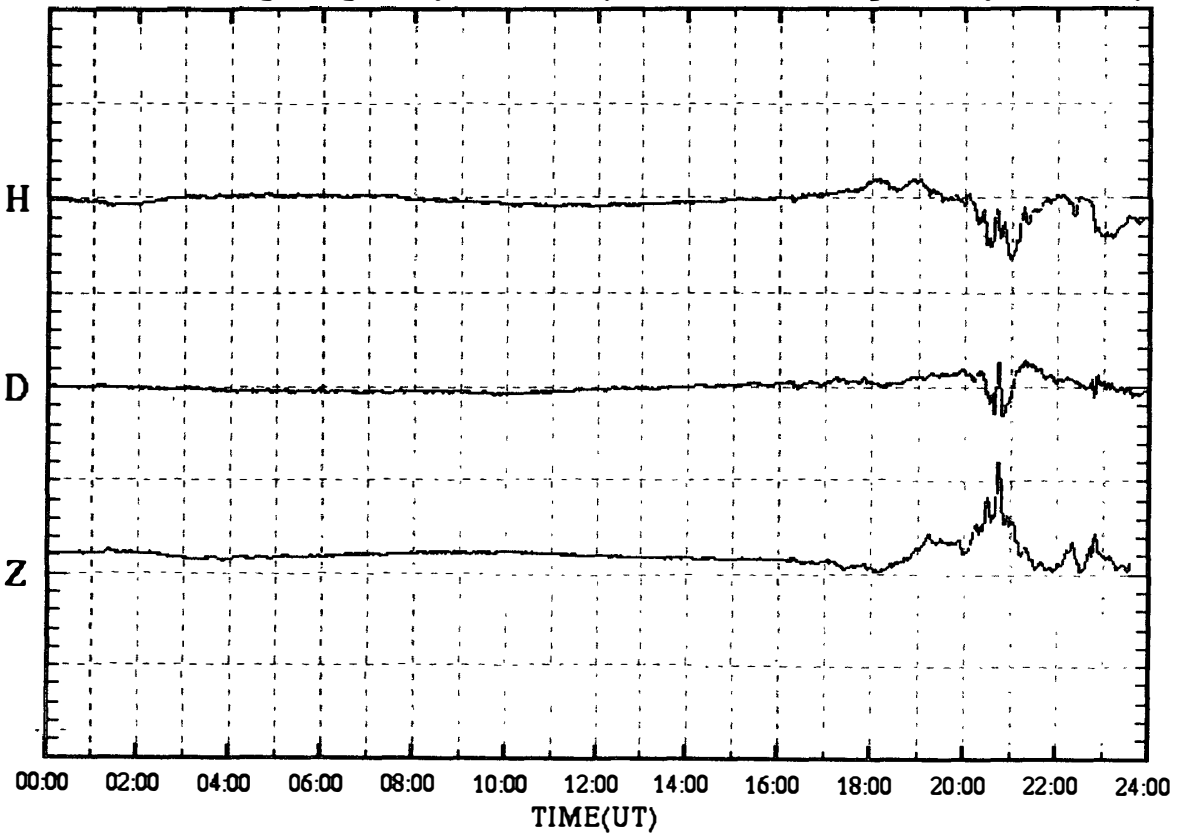

SYOWA magnetogram (100 nT/div)

25 Sep.2000 (DAY:269)

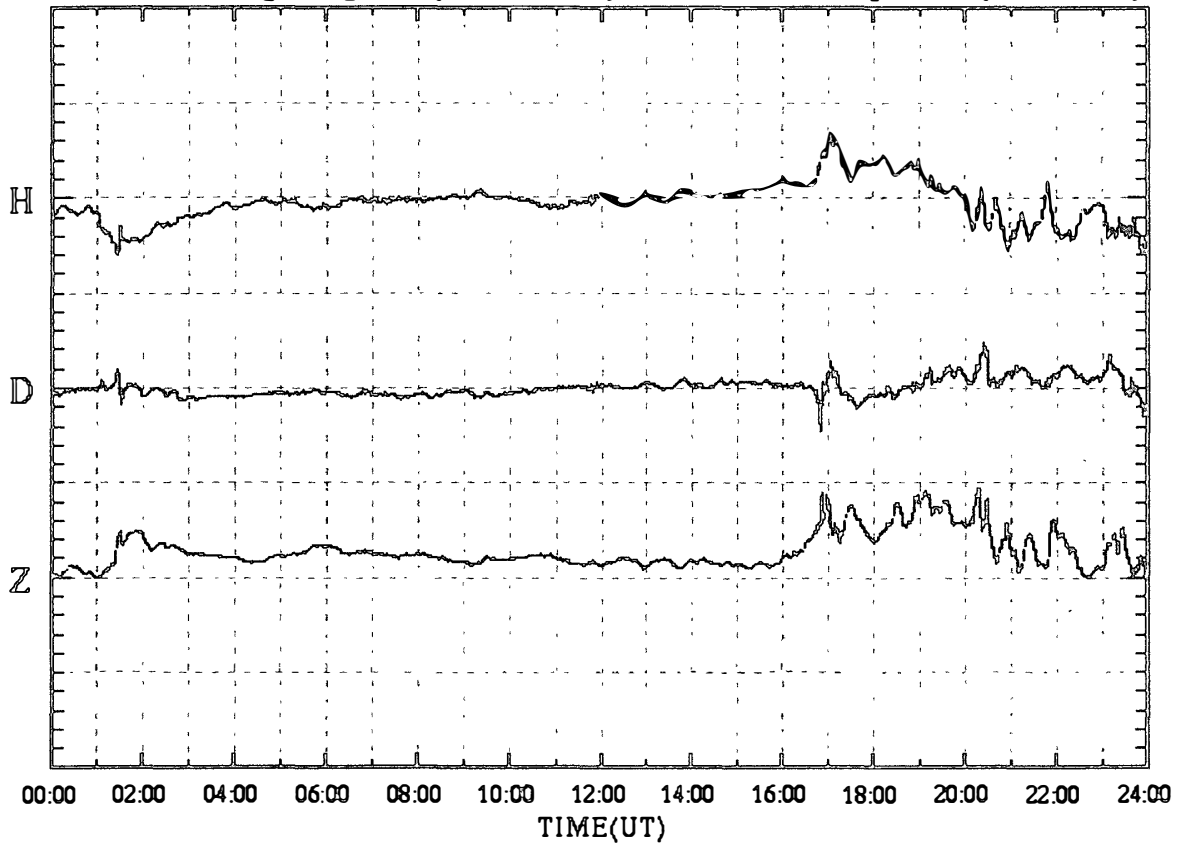

SYOWA magnetogram (100 nT/div)

26 Sep.2000 (DAY:270)

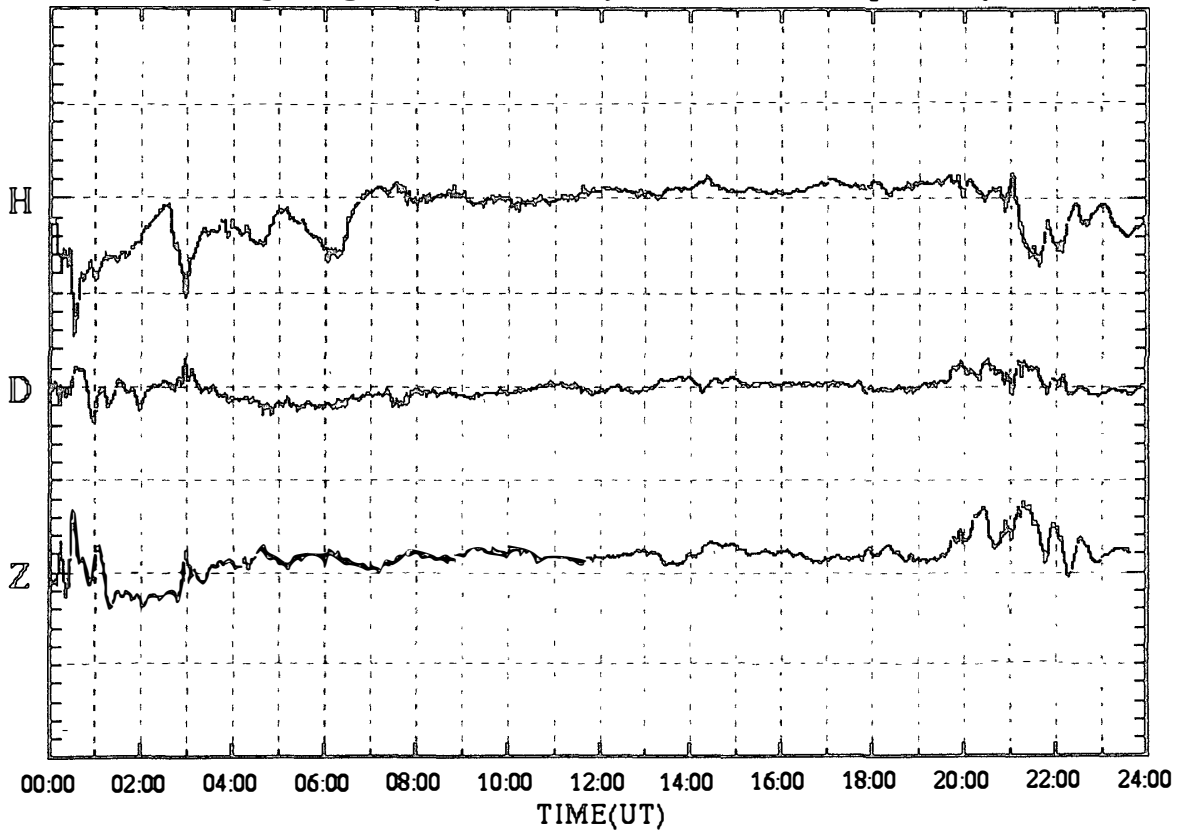

SYOWA magnetogram (100 nT/div)

27 Sep.2000 (DAY:271)

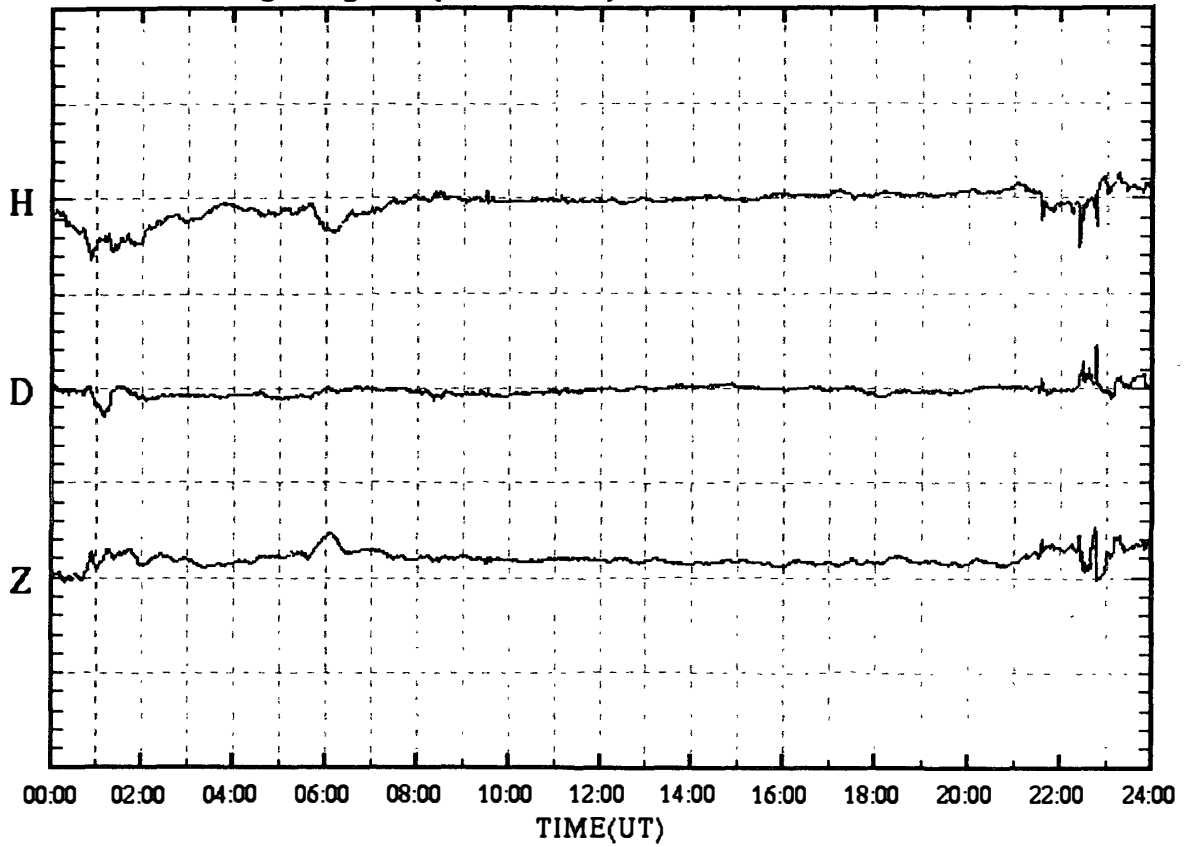

SYOWA magnetogram (100 nT/div)

28 Sep.2000 (DAY:272)

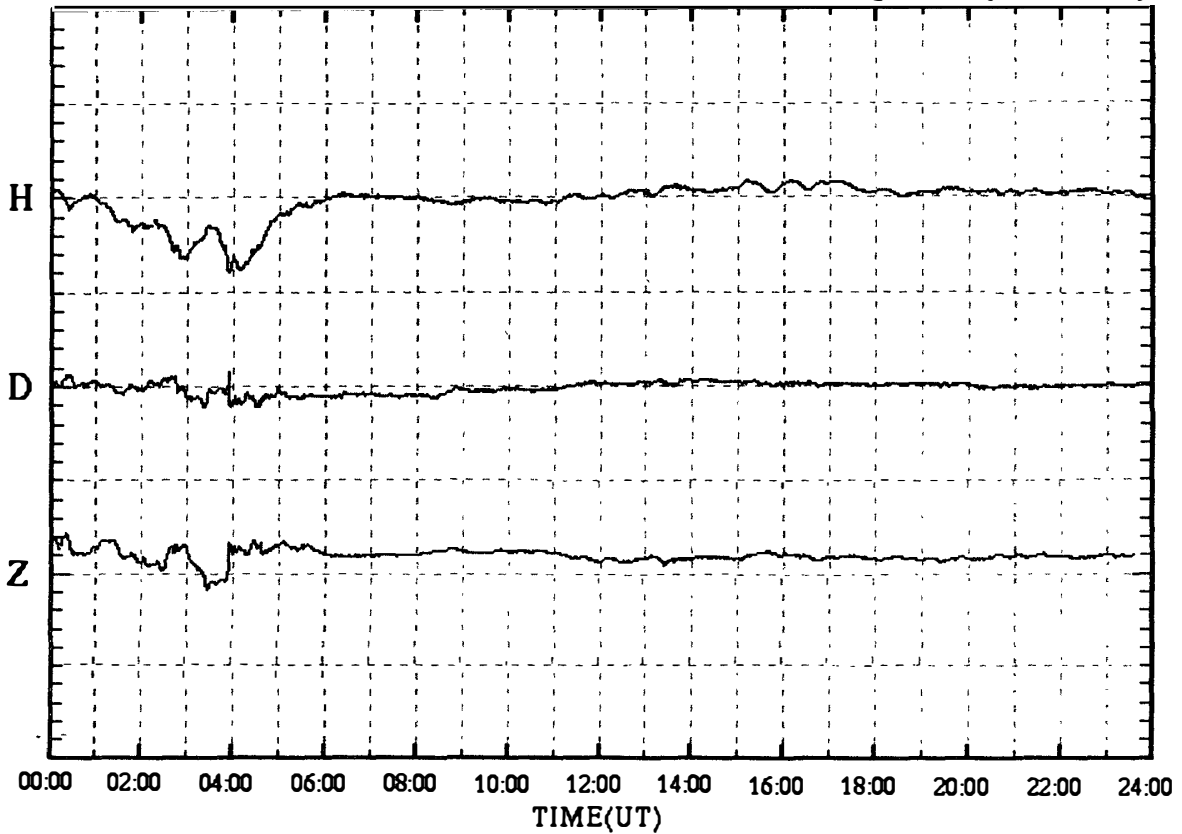

SYOWA magnetogram (100 nT/div)

29 Sep.2000 (DAY:273)

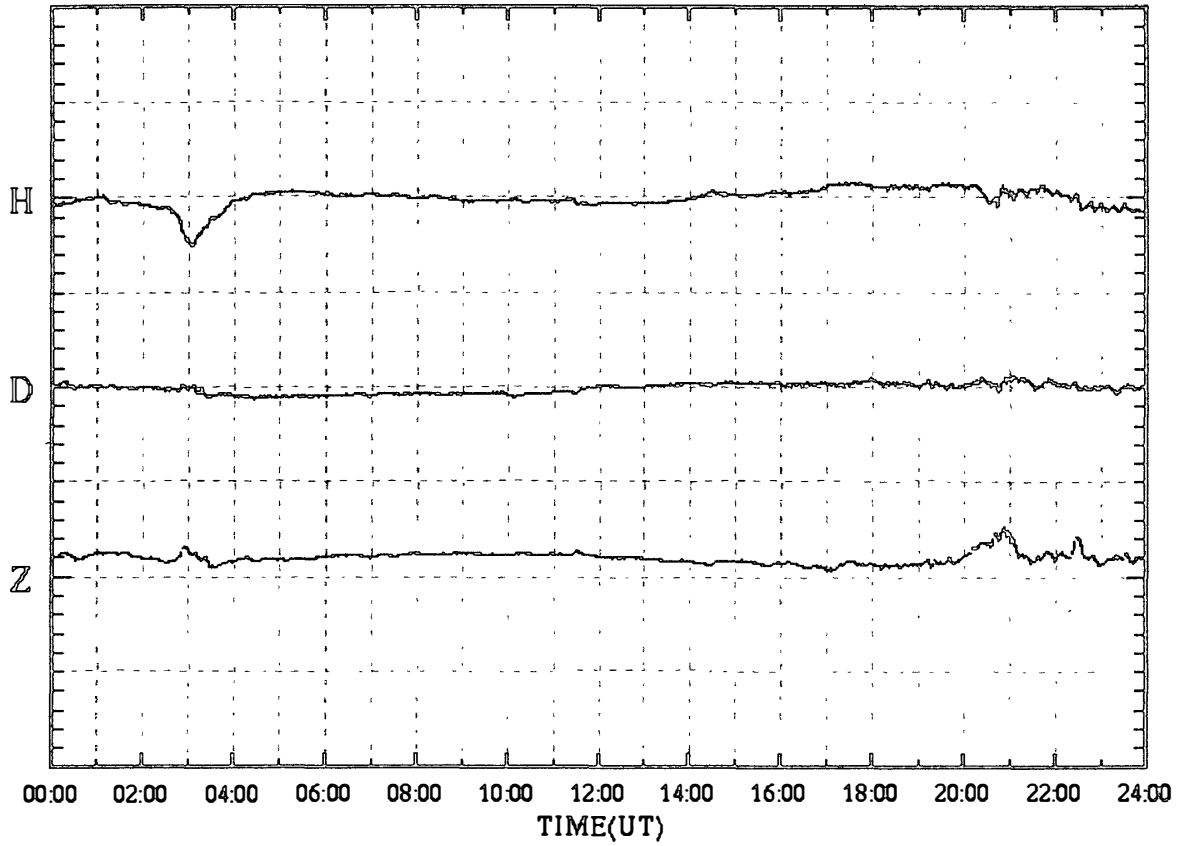

SYOWA magnetogram (100 nT/div)

30 Sep.2000 (DAY:274)

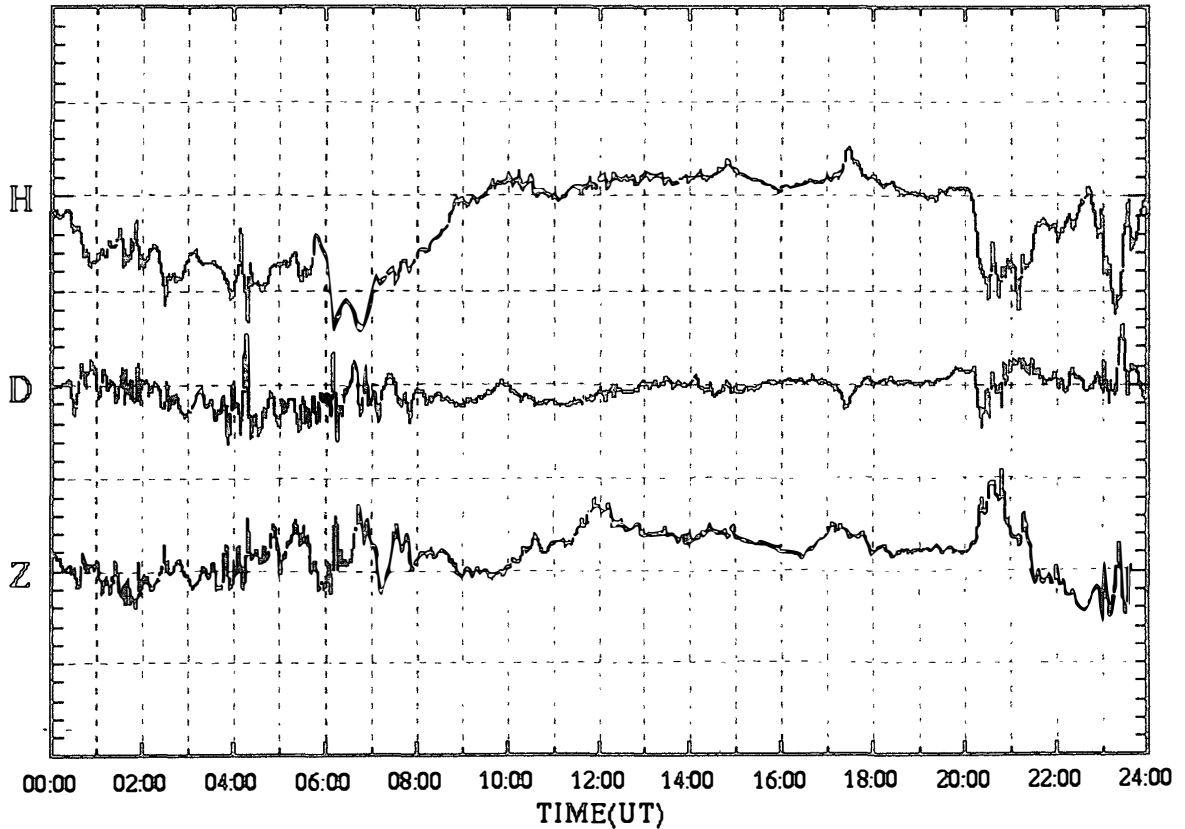

SYOWA magnetogram (100 nT/div)

01 Oct.2000 (DAY:275)

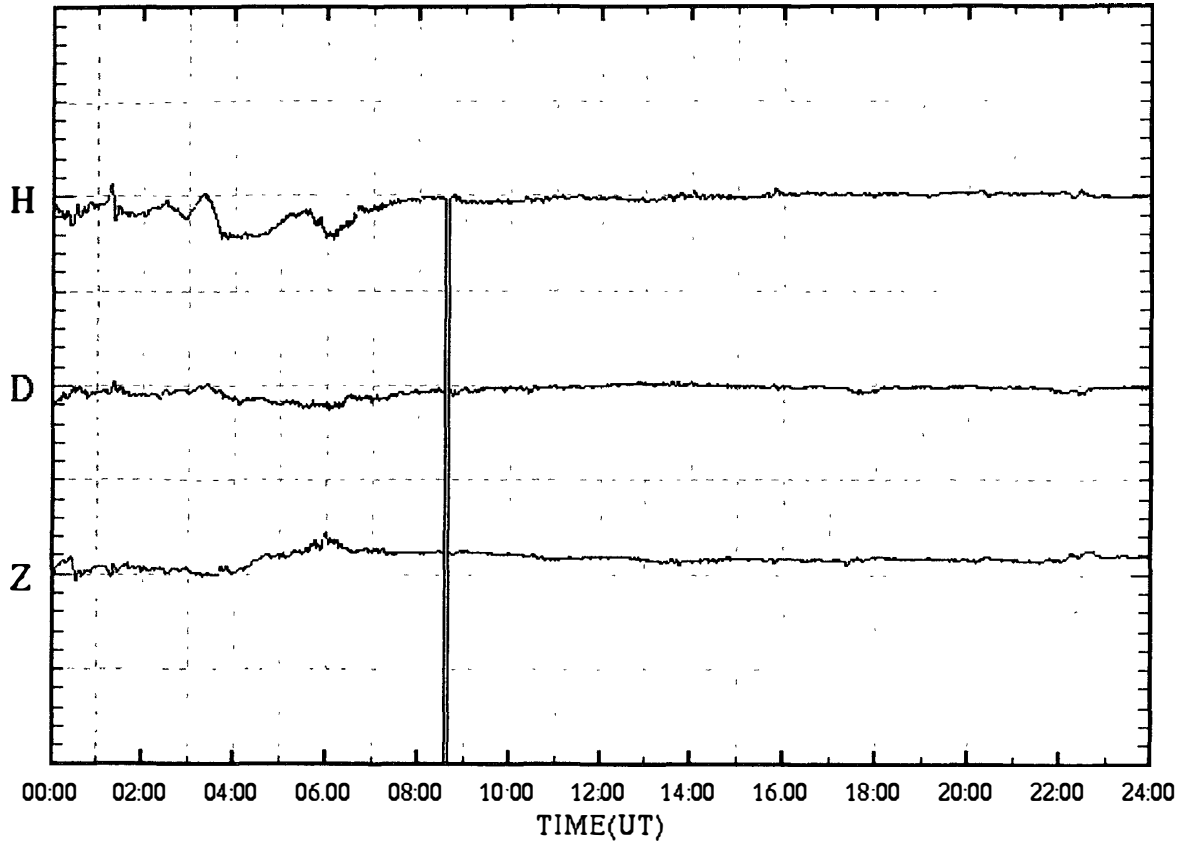

SYOWA magnetogram (100 nT/div)

02 Oct.2000 (DAY:276)

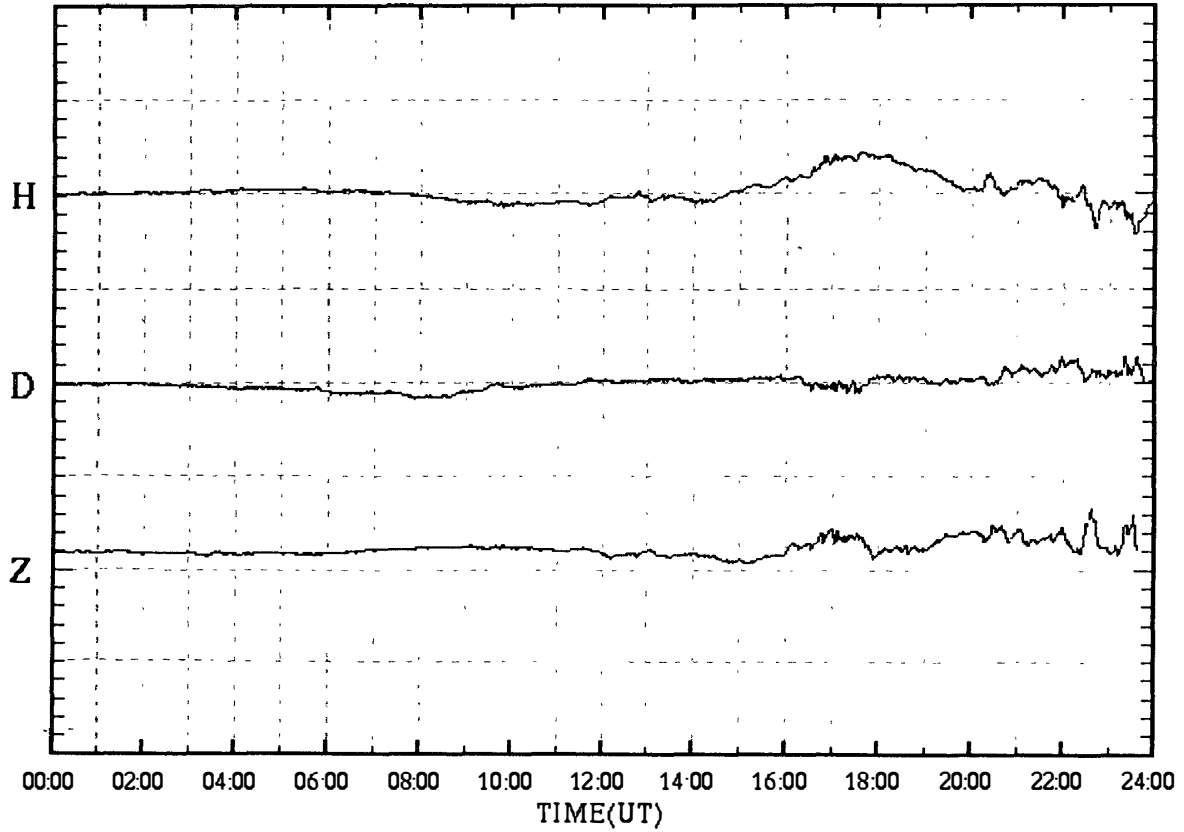

SYOWA magnetogram (100 nT/div)

03 Oct.2000 (DAY:277)

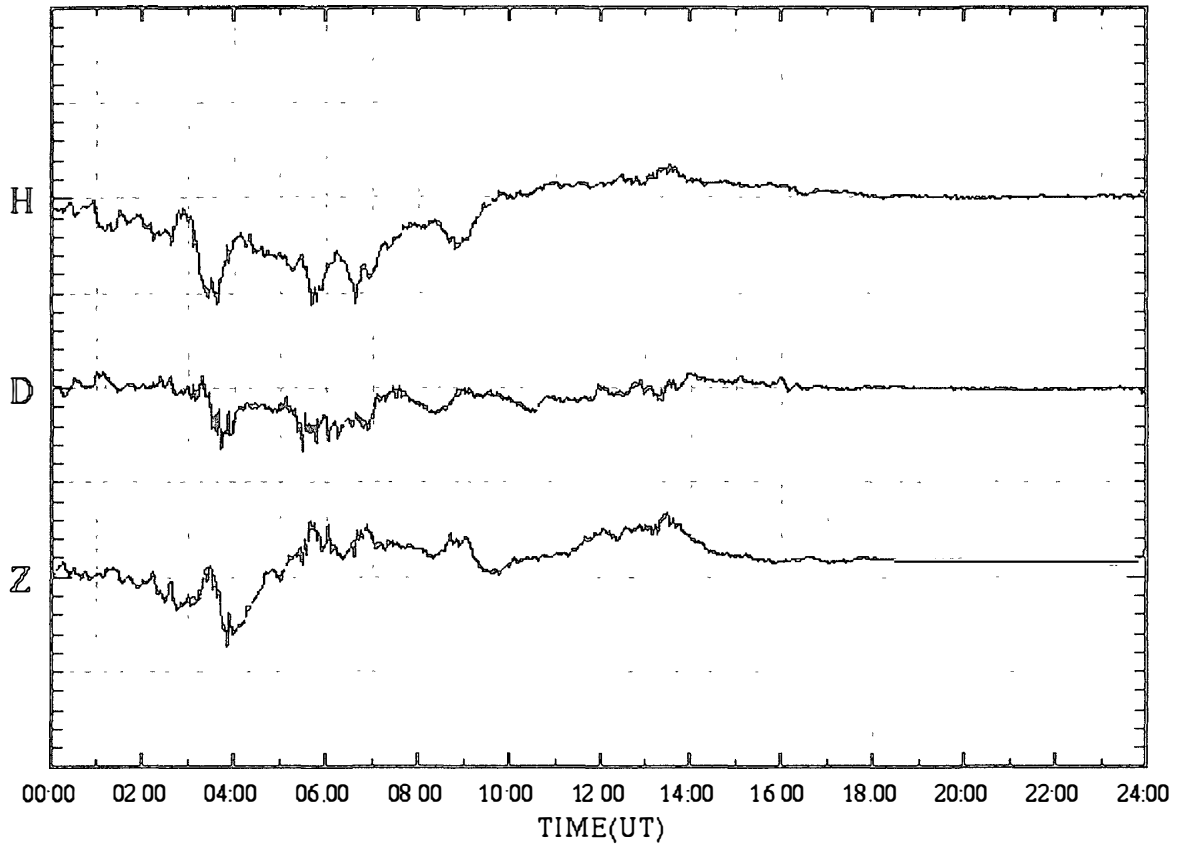

SYOWA magnetogram (100 nT/div)

04 Oct.2000 (DAY:278)

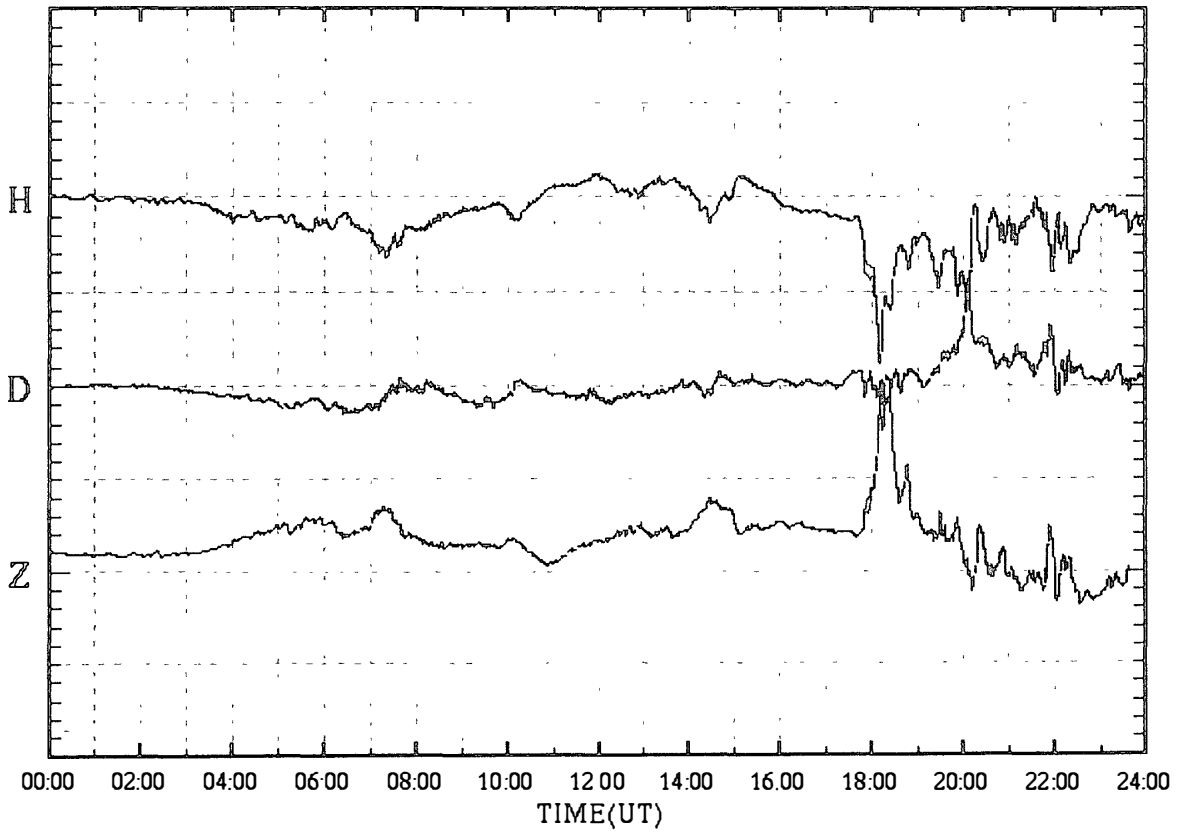

SYOWA magnetogram (100 nT/div)

05 Oct.2000 (DAY:279)

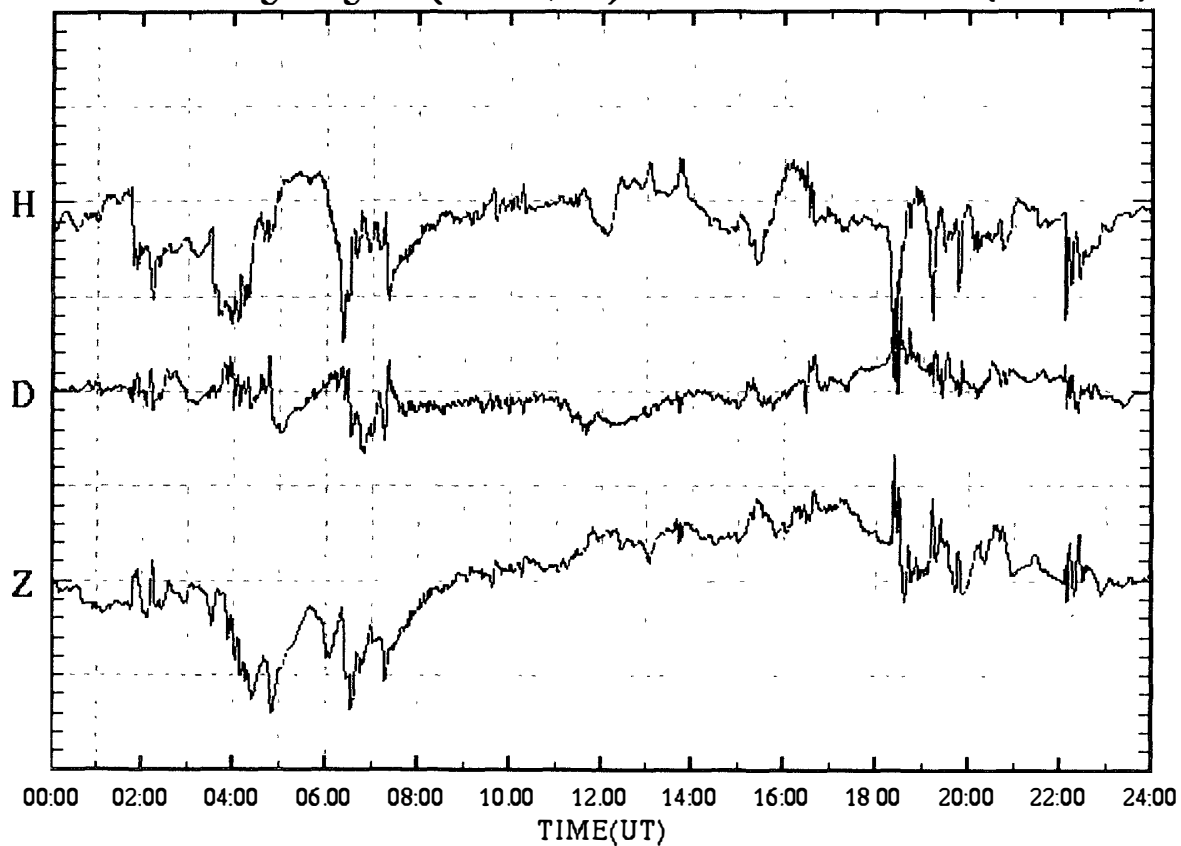

SYOWA magnetogram (100 nT/div)

06 Oct.2000 (DAY:280)

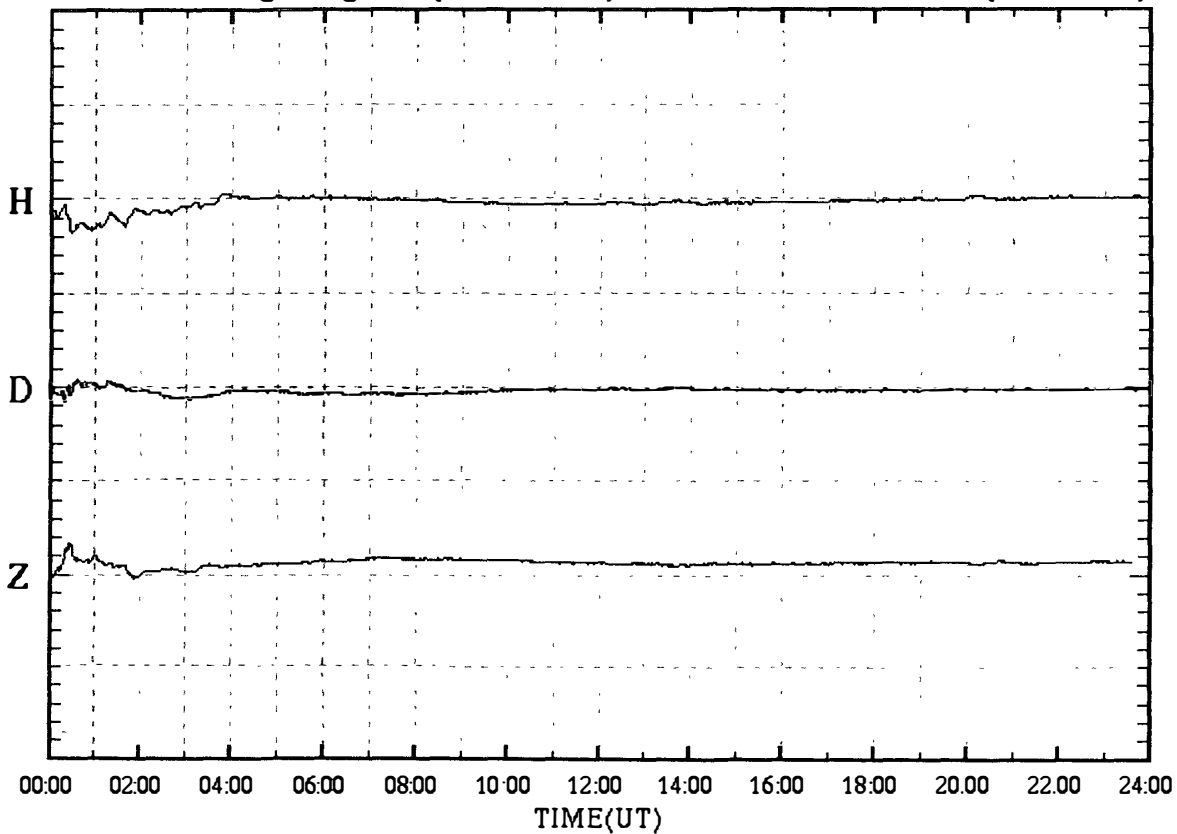

SYOWA magnetogram (100 nT/div)

07 Oct.2000 (DAY:281)

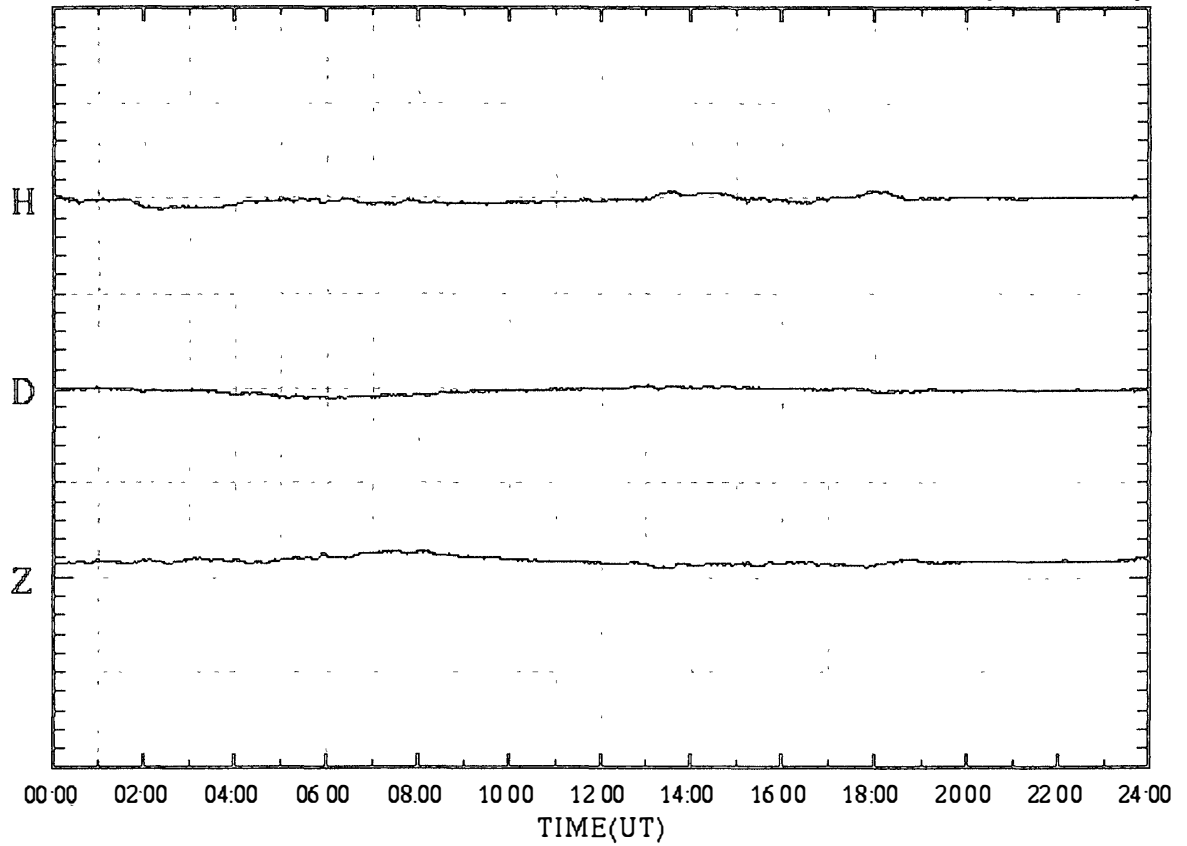

SYOWA magnetogram (100 nT/div)

08 Oct.2000 (DAY:282)

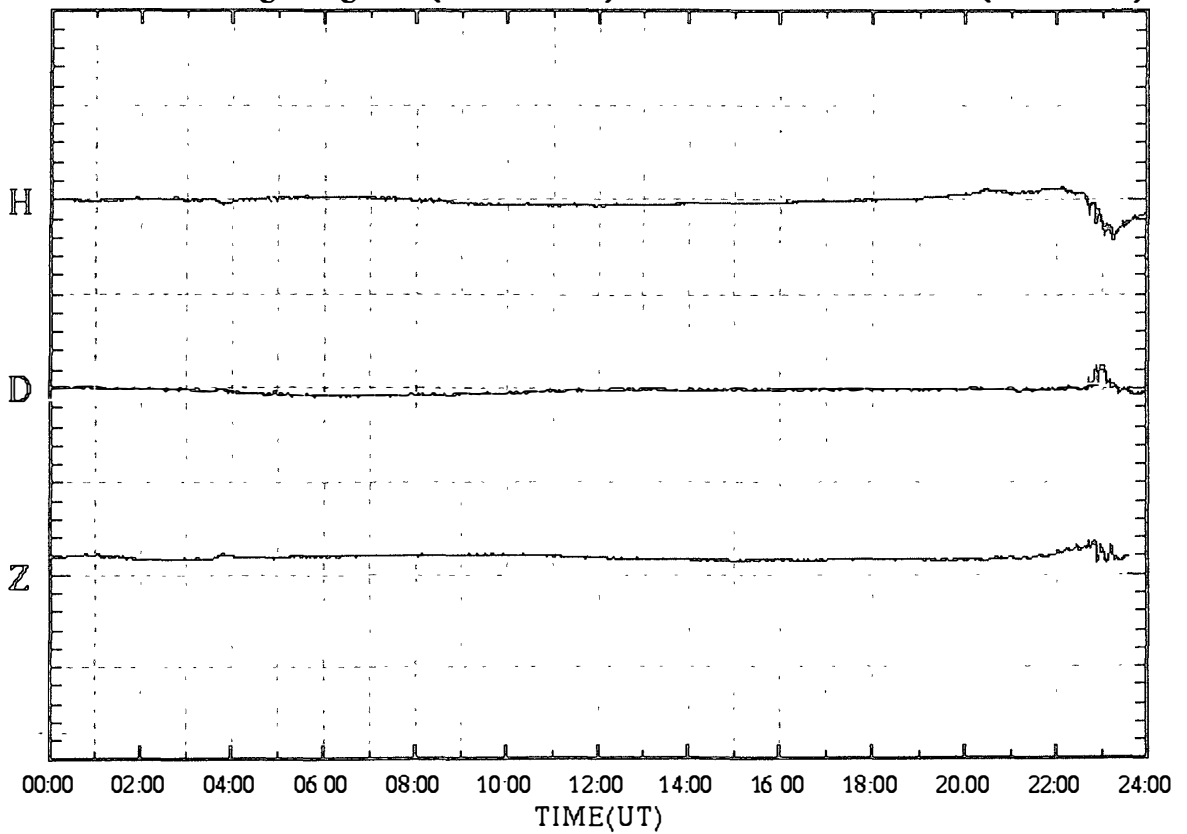

SYOWA magnetogram (100 nT/div)

09 Oct.2000 (DAY:283)

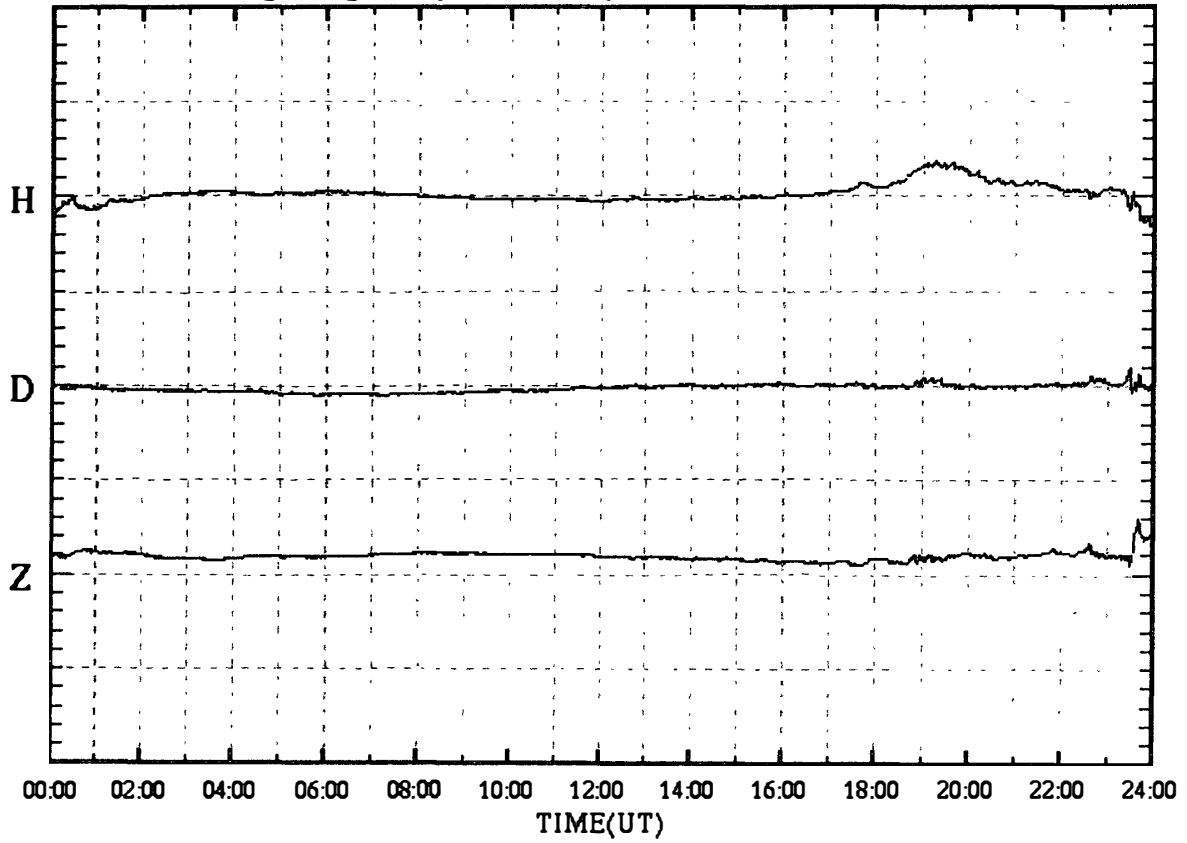

SYOWA magnetogram (100 nT/div)

10 Oct.2000 (DAY:284)

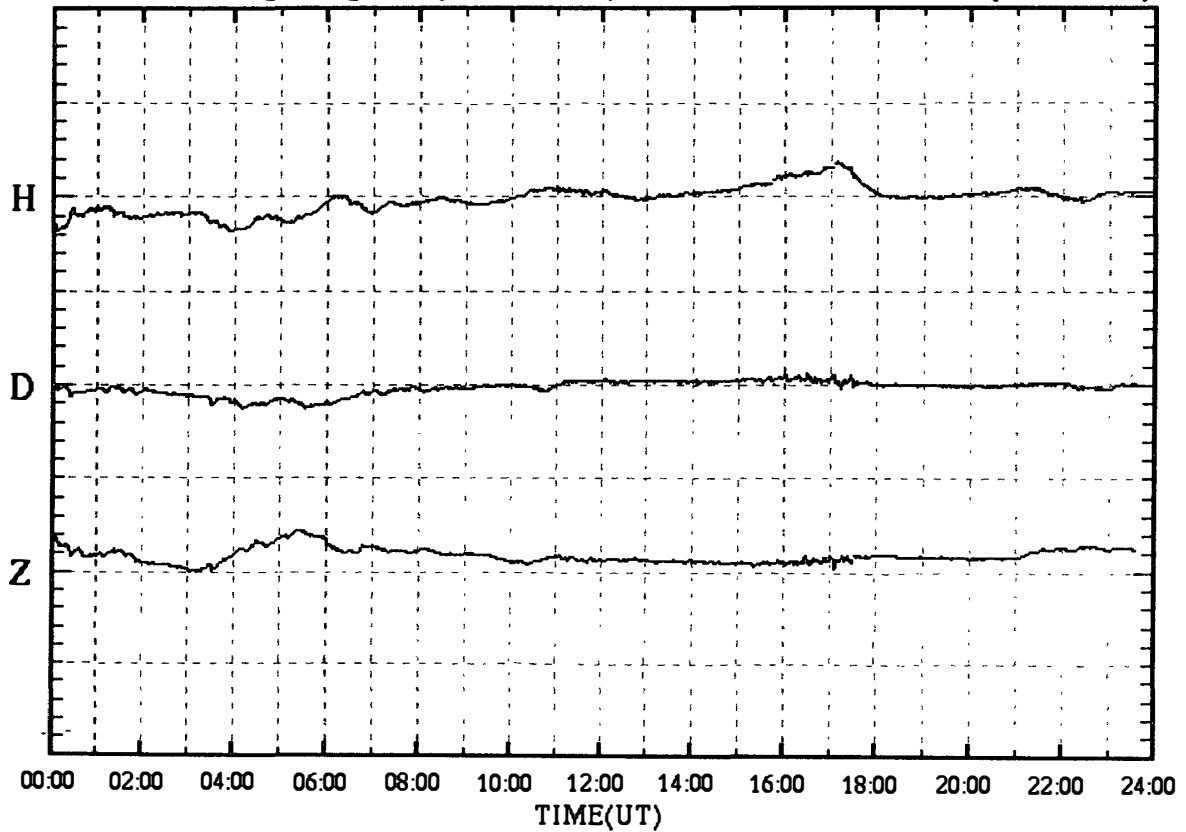

SYOWA magnetogram (100 nT/div)

11 Oct.2000 (DAY:285)

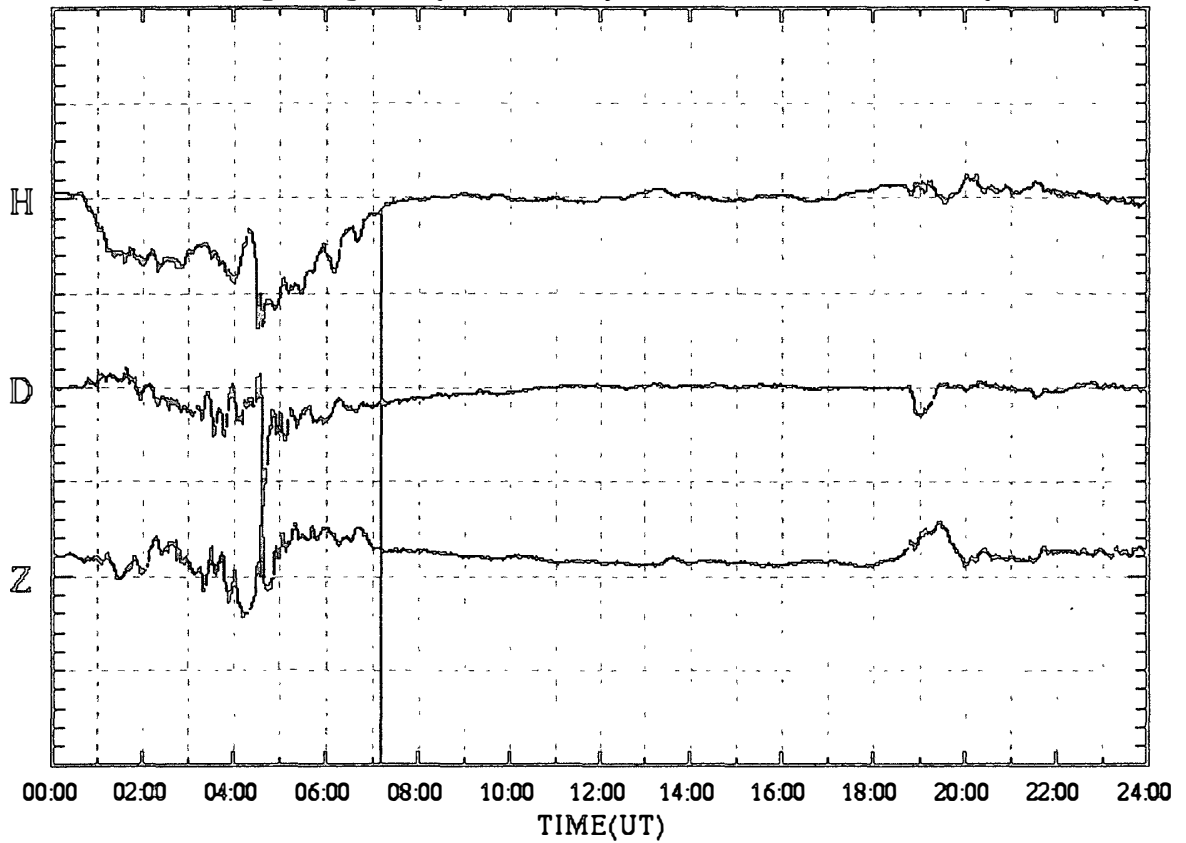

SYOWA magnetogram (100 nT/div)

12 Oct.2000 (DAY:286)

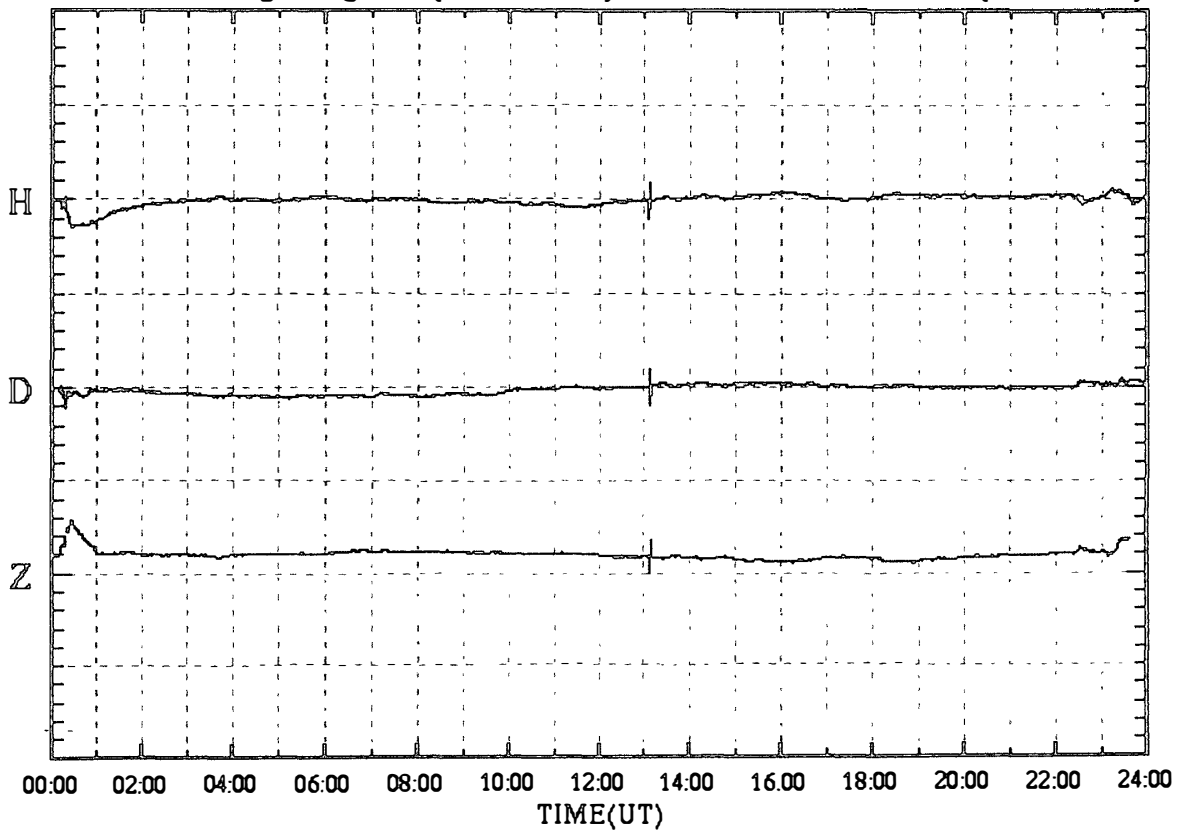

SYOWA magnetogram (100 nT/div)

13 Oct.2000 (DAY:287)

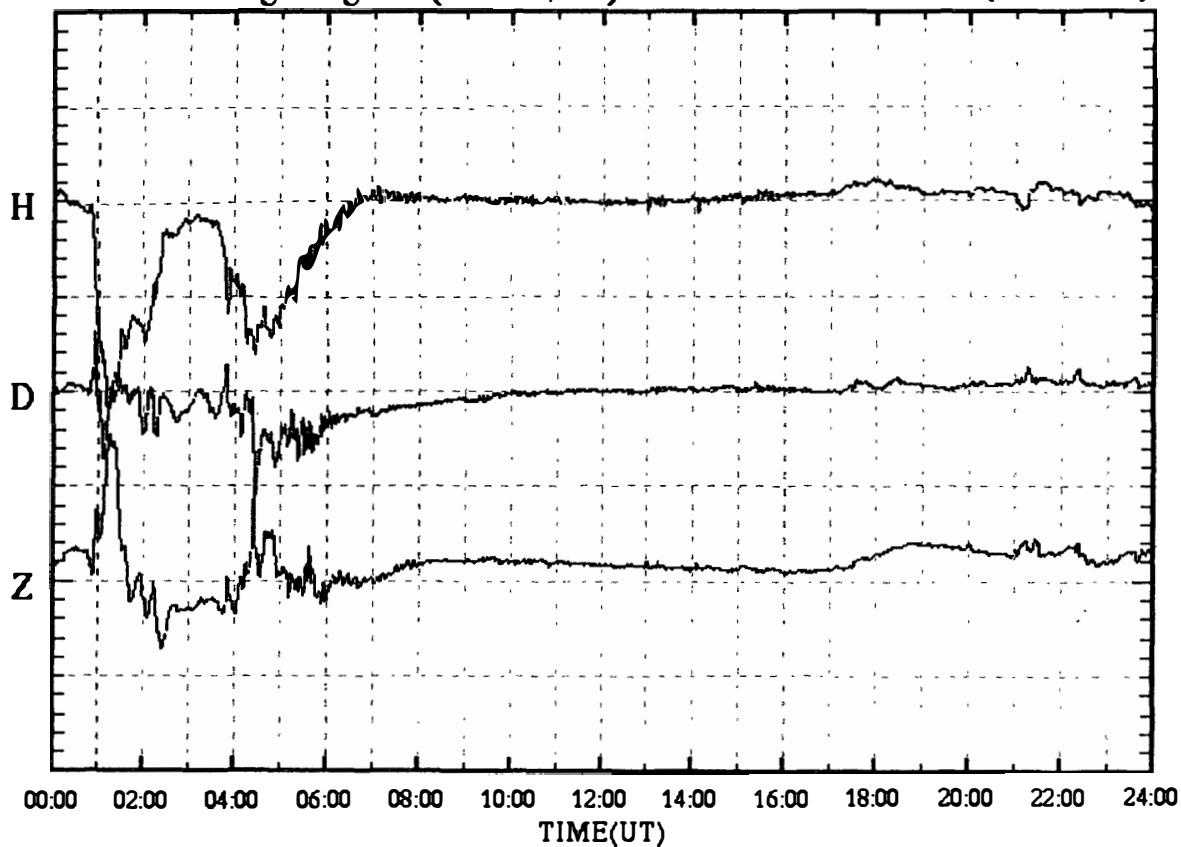

SYOWA magnetogram (100 nT/div)

14 Oct.2000 (DAY:288)

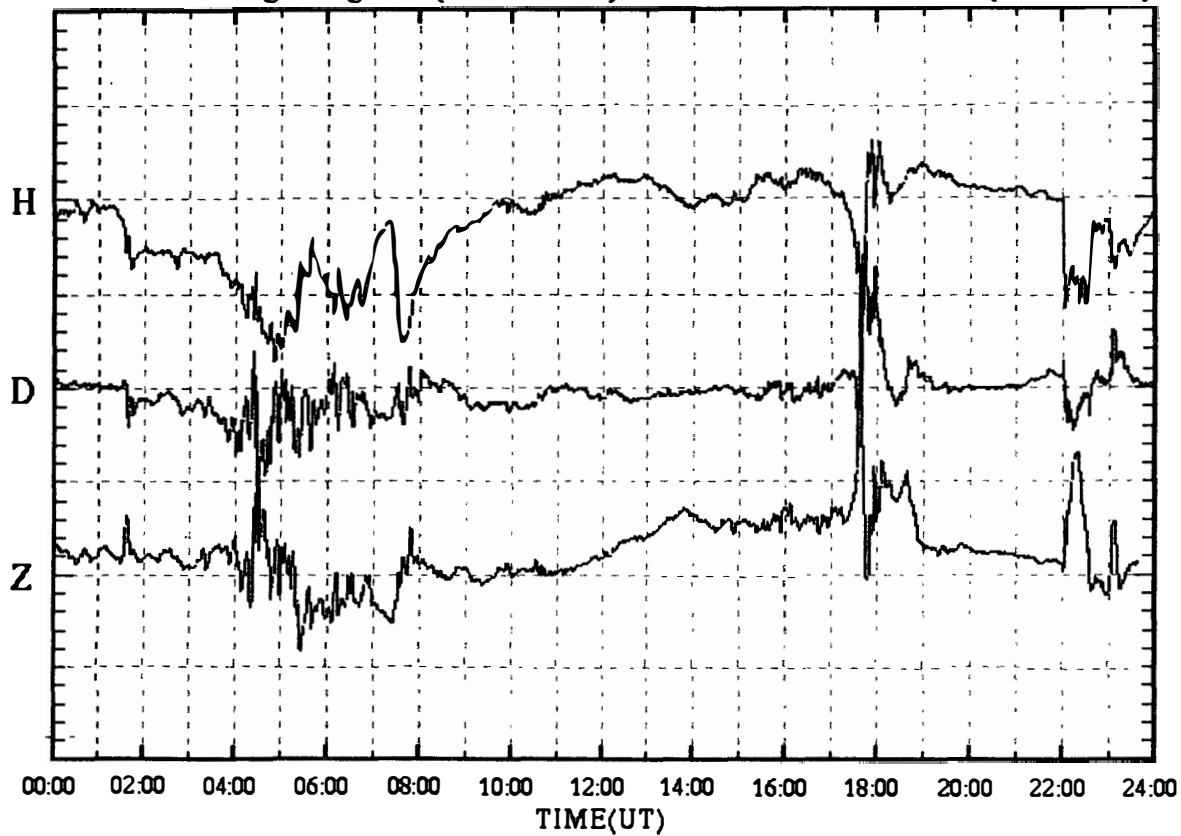

SYOWA magnetogram (100 nT/div)

15 Oct.2000 (DAY:289)

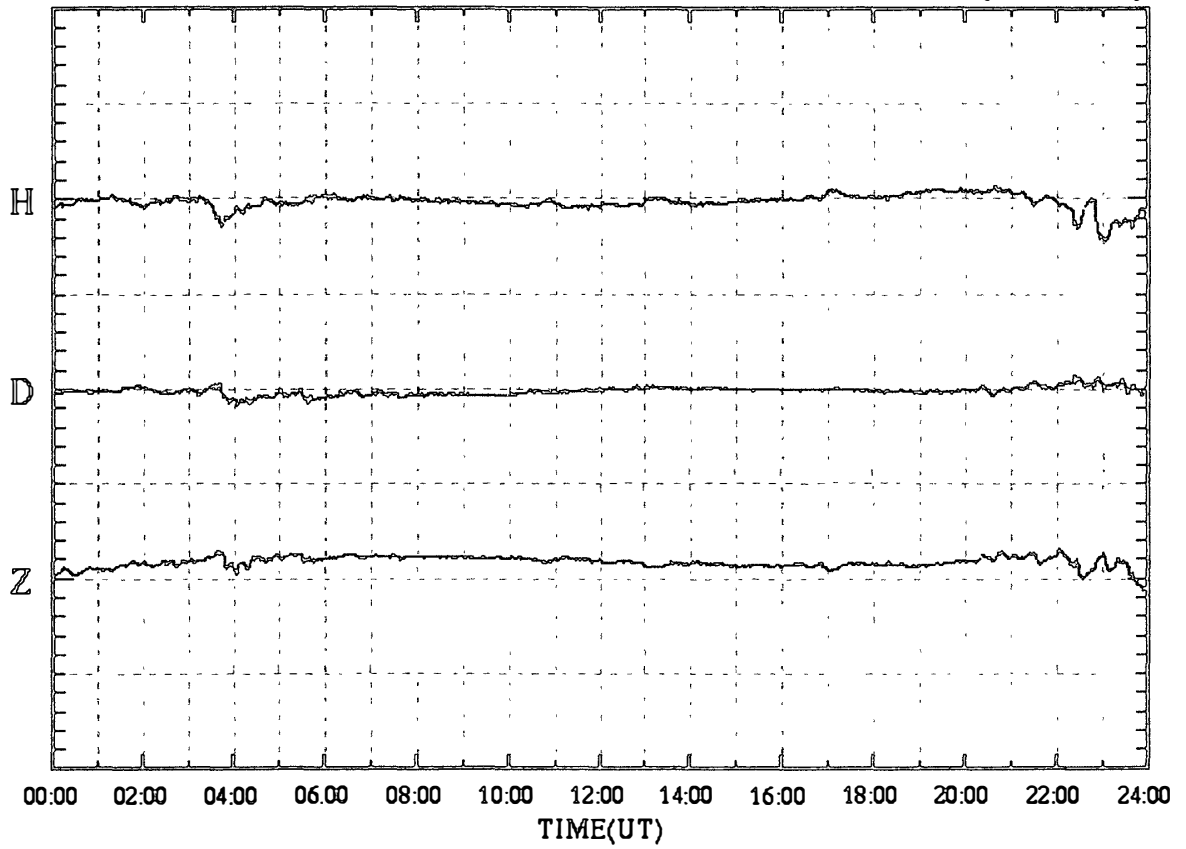

SYOWA magnetogram (100 nT/div)

16 Oct.2000 (DAY:290)

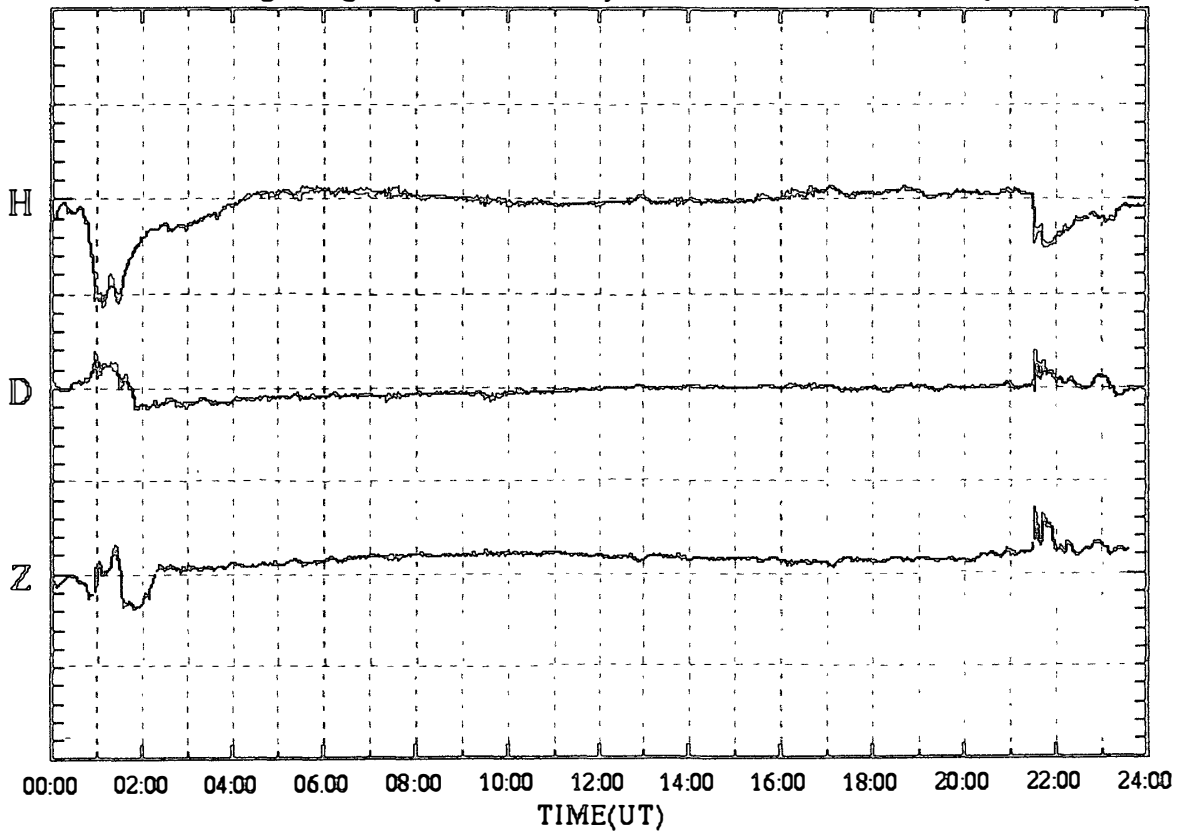

SYOWA magnetogram (100 nT/div)

17 Oct.2000 (DAY:291)

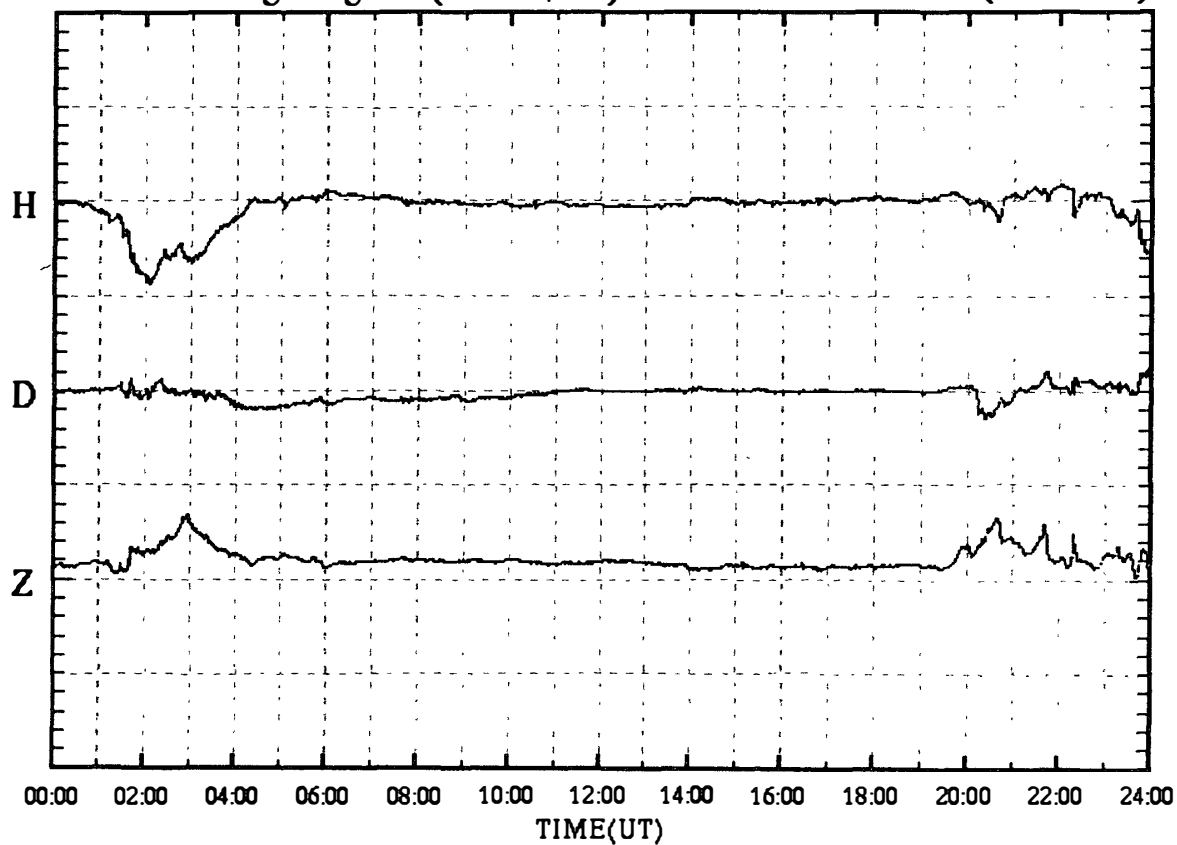

SYOWA magnetogram (100 nT/div)

18 Oct.2000 (DAY:292)

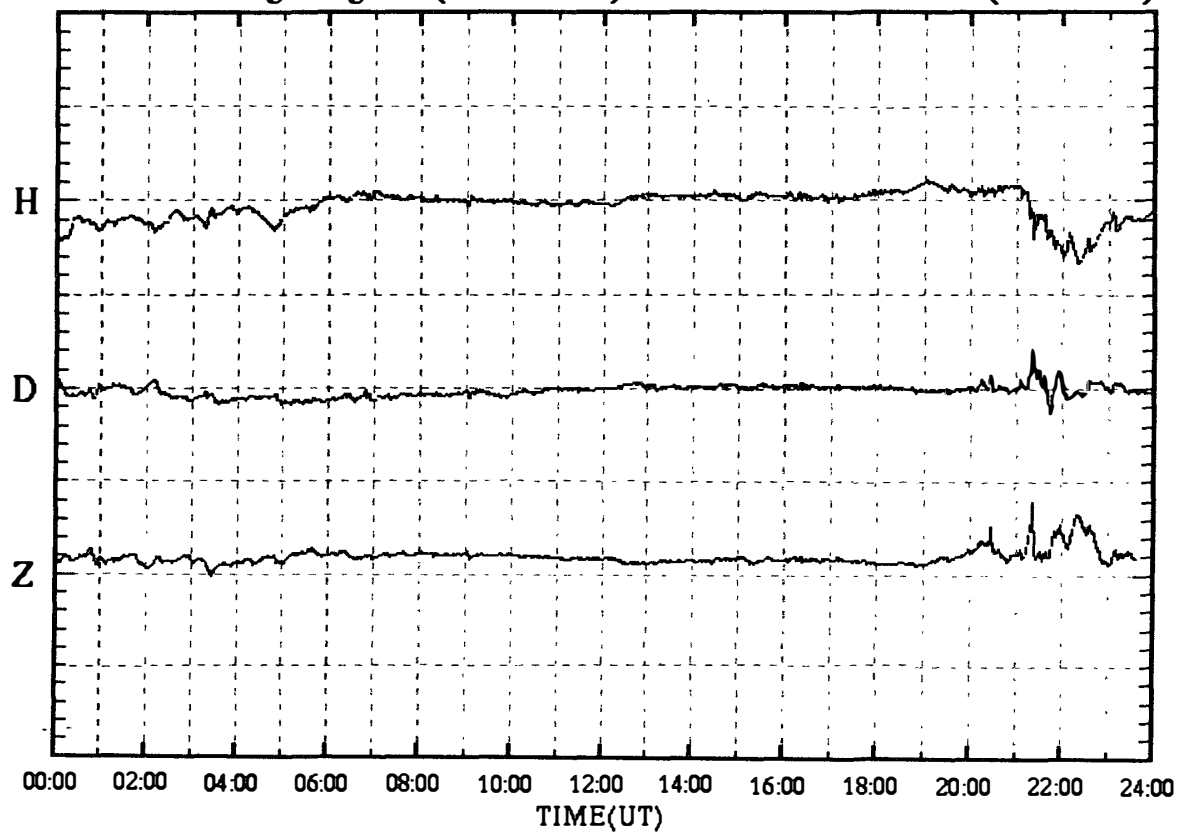

SYOWA magnetogram (100 nT/div)

19 Oct.2000 (DAY:293)

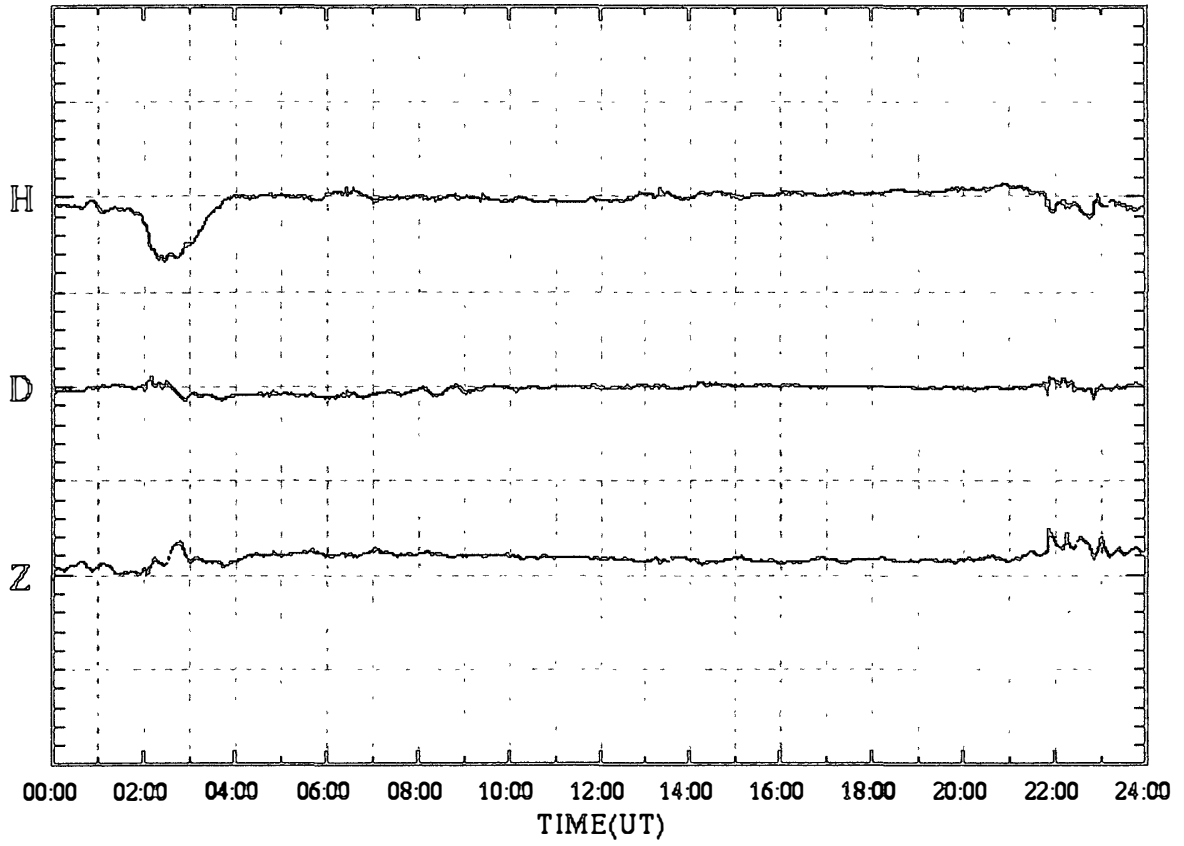

SYOWA magnetogram (100 nT/div)

20 Oct.2000 (DAY:294)

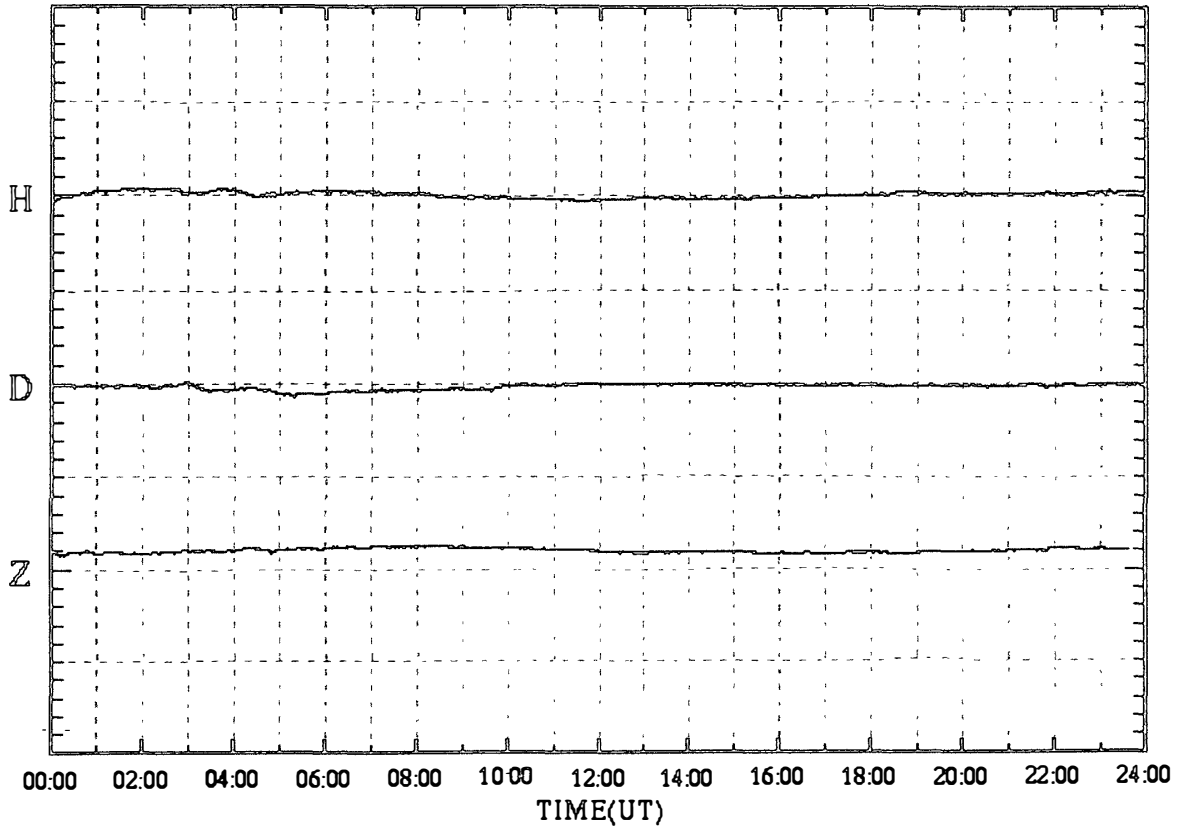

SYOWA magnetogram (100 nT/div)

21 Oct.2000 (DAY:295)

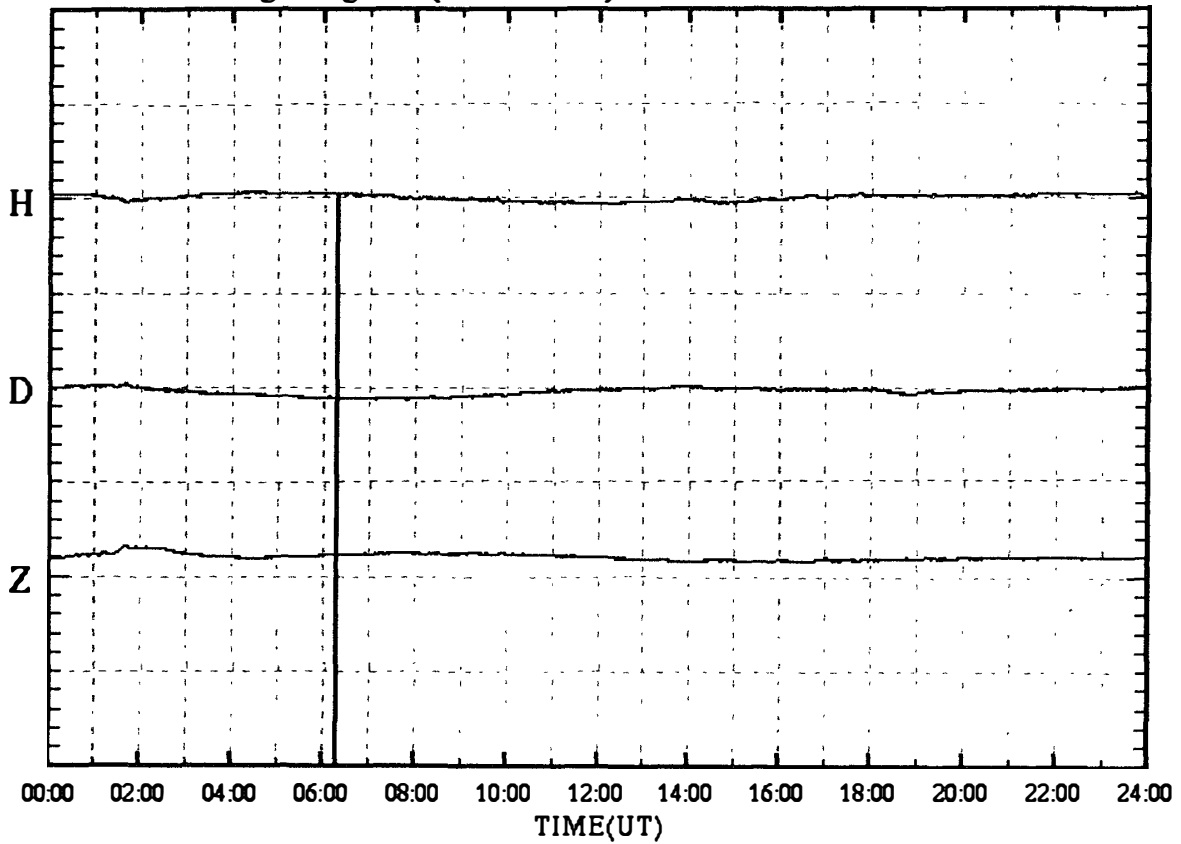

SYOWA magnetogram (100 nT/div)

22 Oct.2000 (DAY:296)

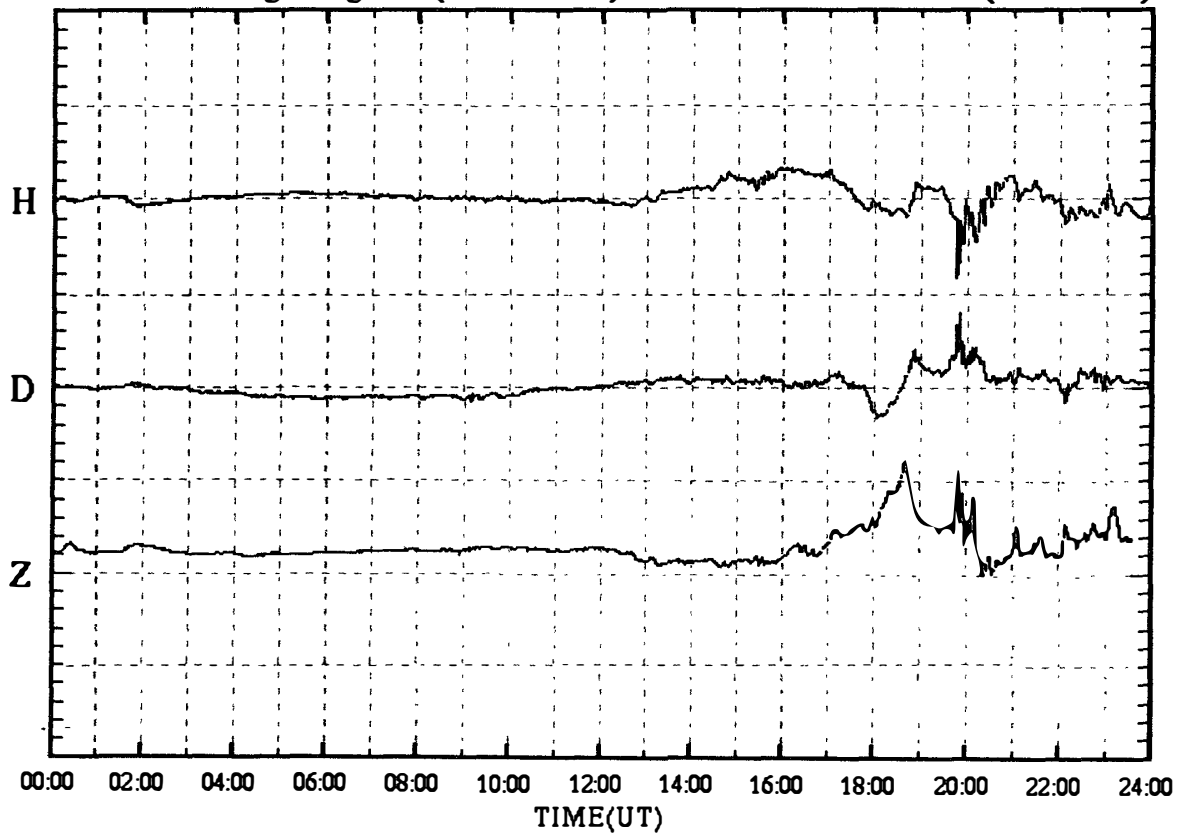

SYOWA magnetogram (100 nT/div)

23 Oct.2000 (DAY:297)

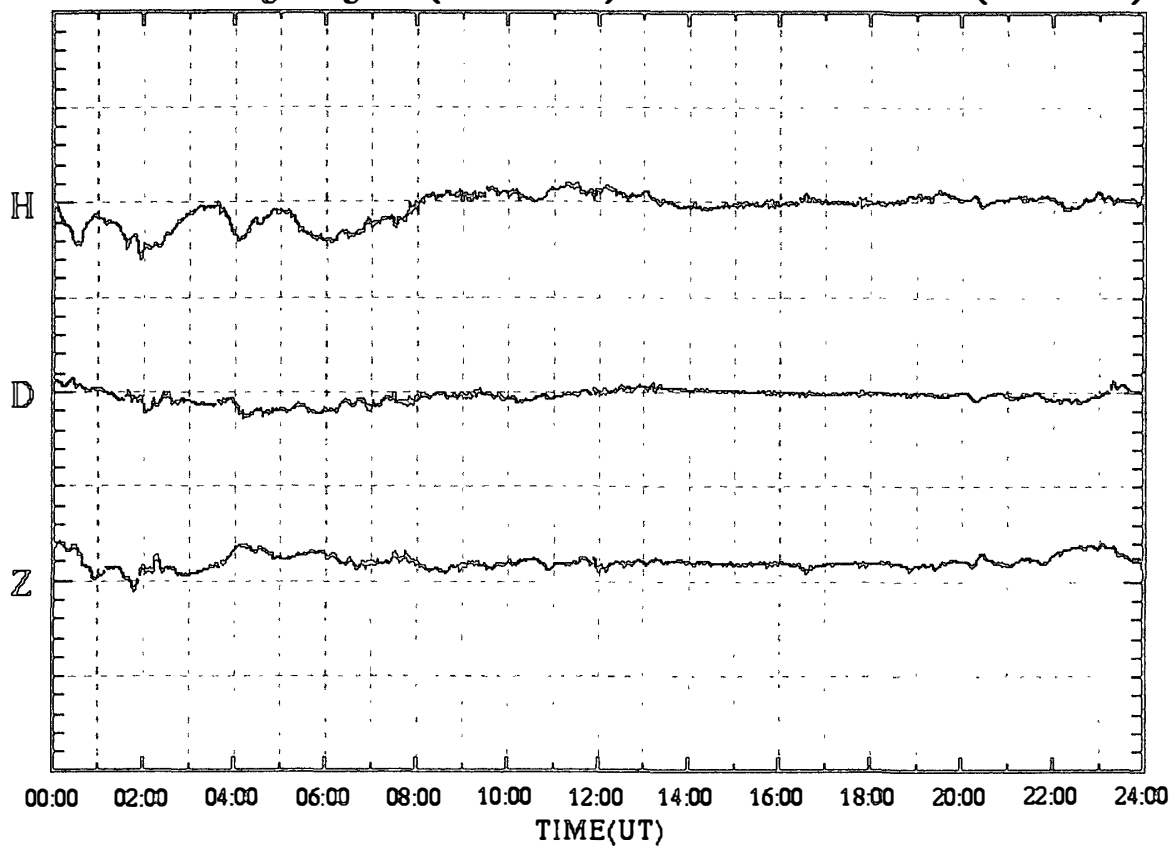

SYOWA magnetogram (100 nT/div)

24 Oct.2000 (DAY:298)

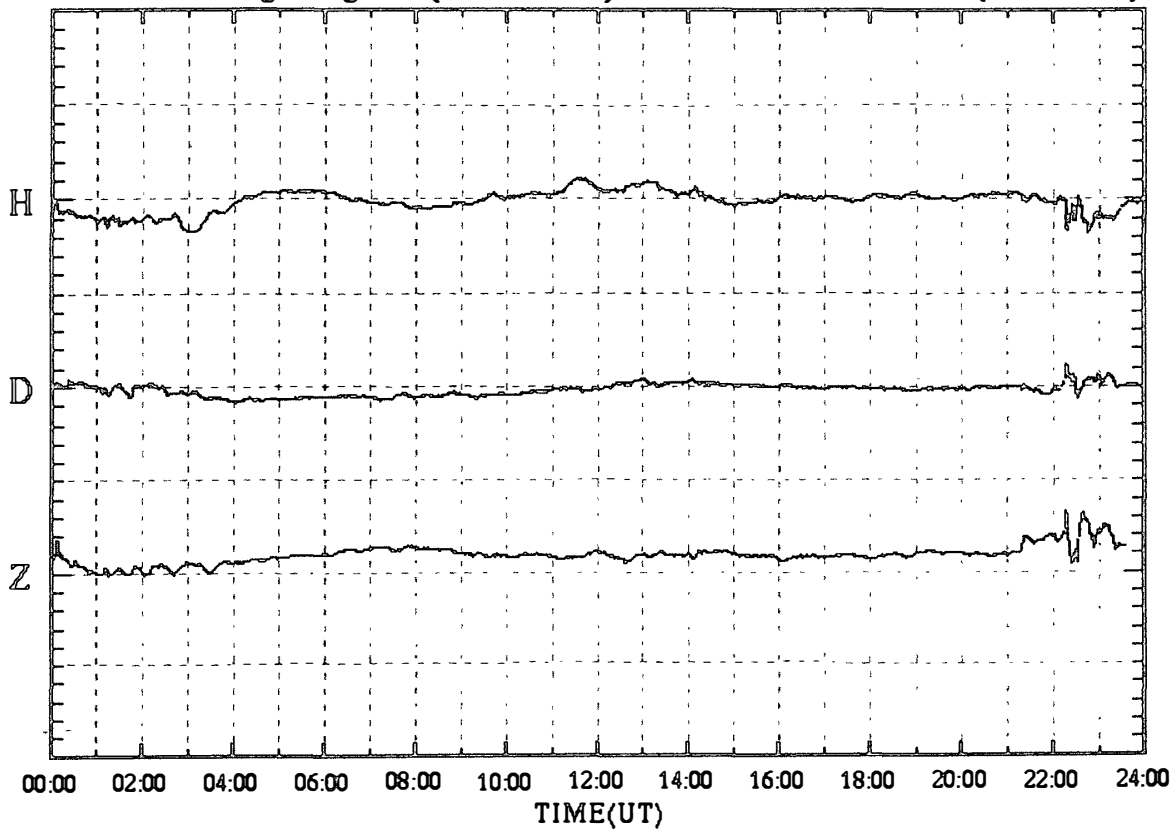

SYOWA magnetogram (100 nT/div)

25 Oct.2000 (DAY:299)

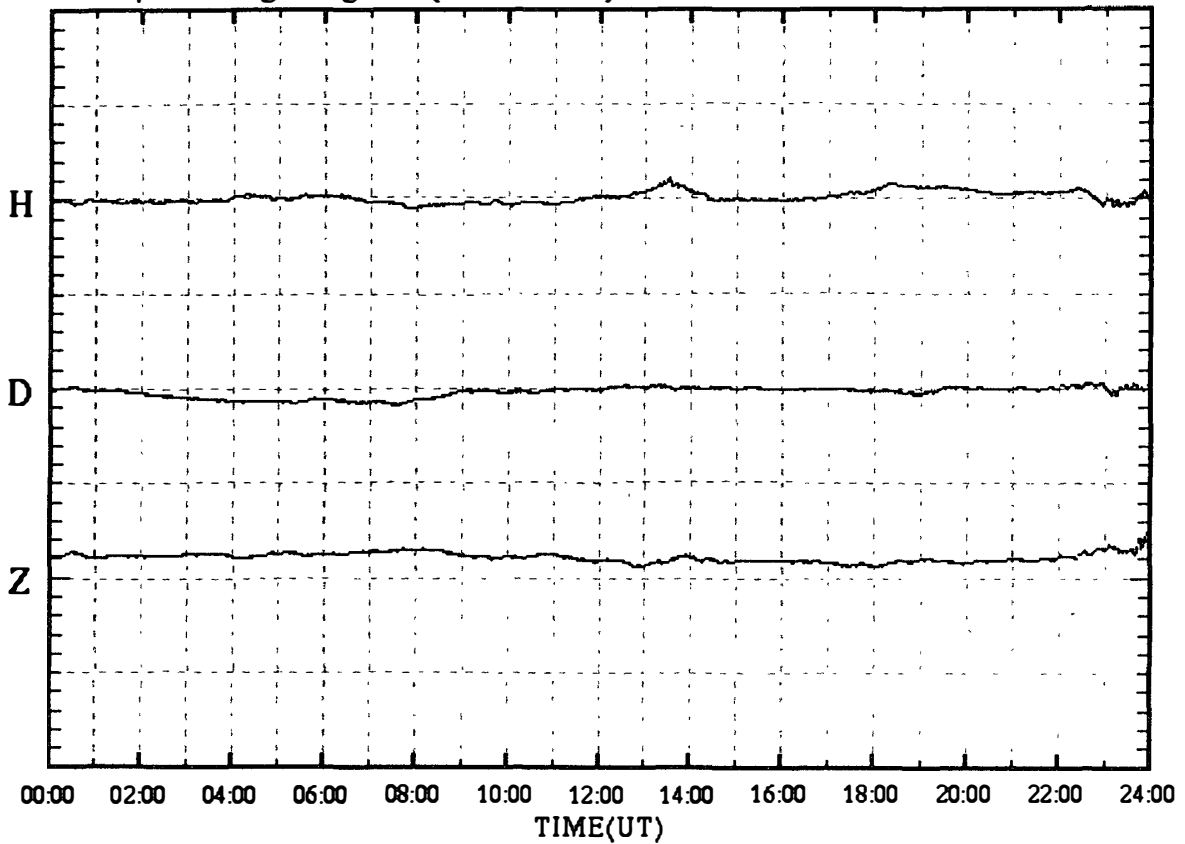

SYOWA magnetogram (100 nT/div)

26 Oct.2000 (DAY:300)

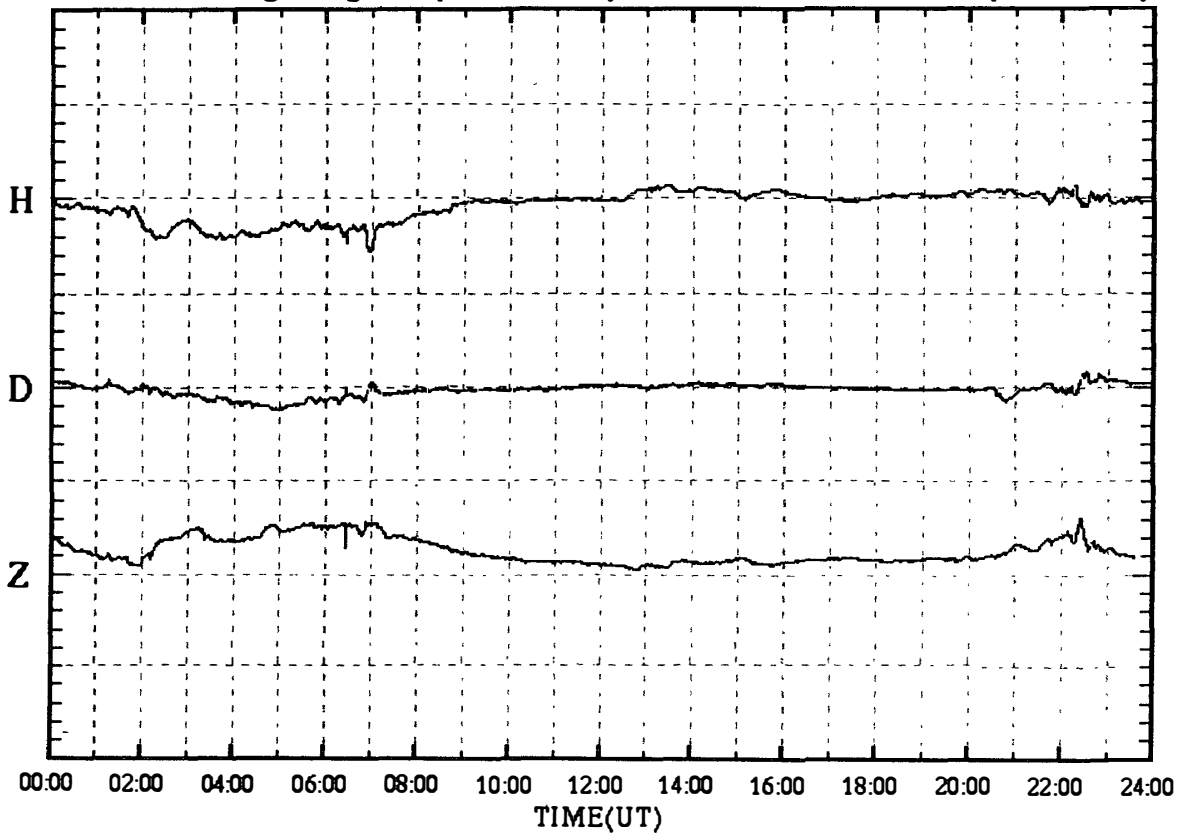

SYOWA magnetogram (100 nT/div)

27 Oct.2000 (DAY:301)

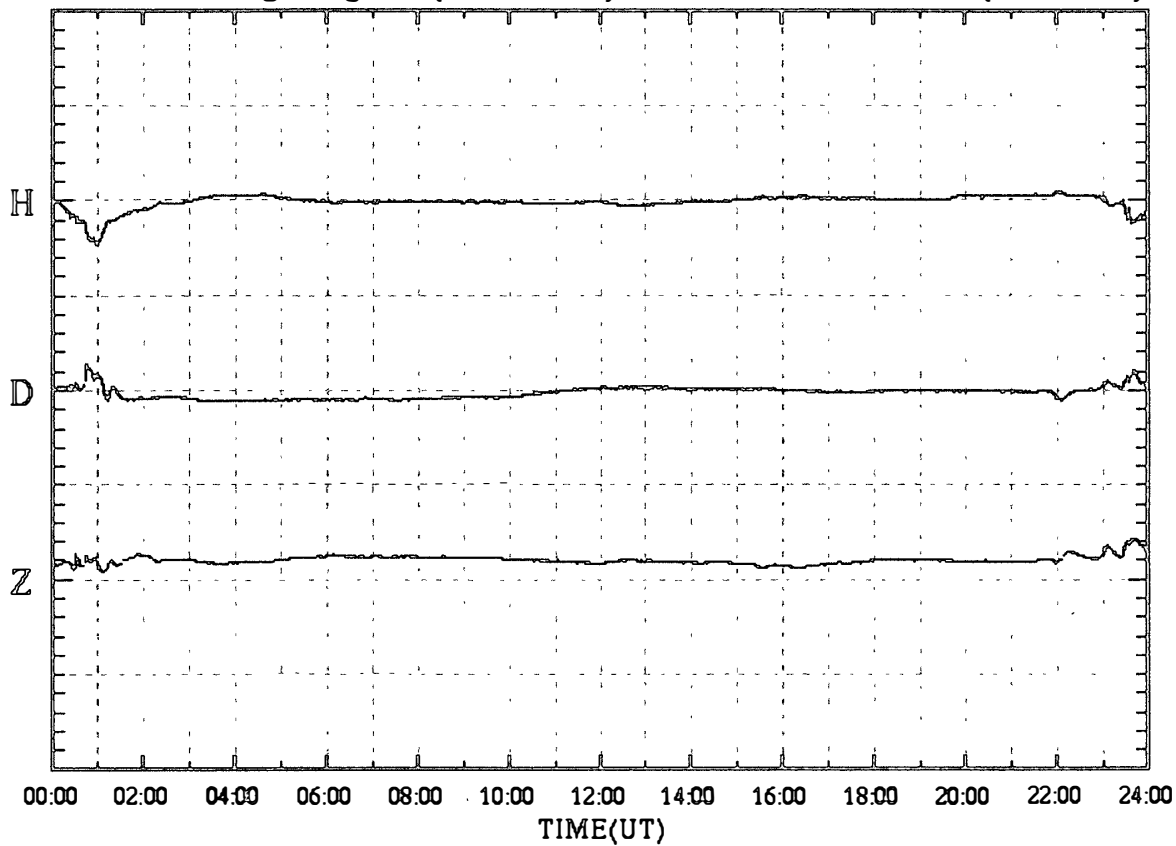

SYOWA magnetogram (100 nT/div)

28 Oct.2000 (DAY:302)

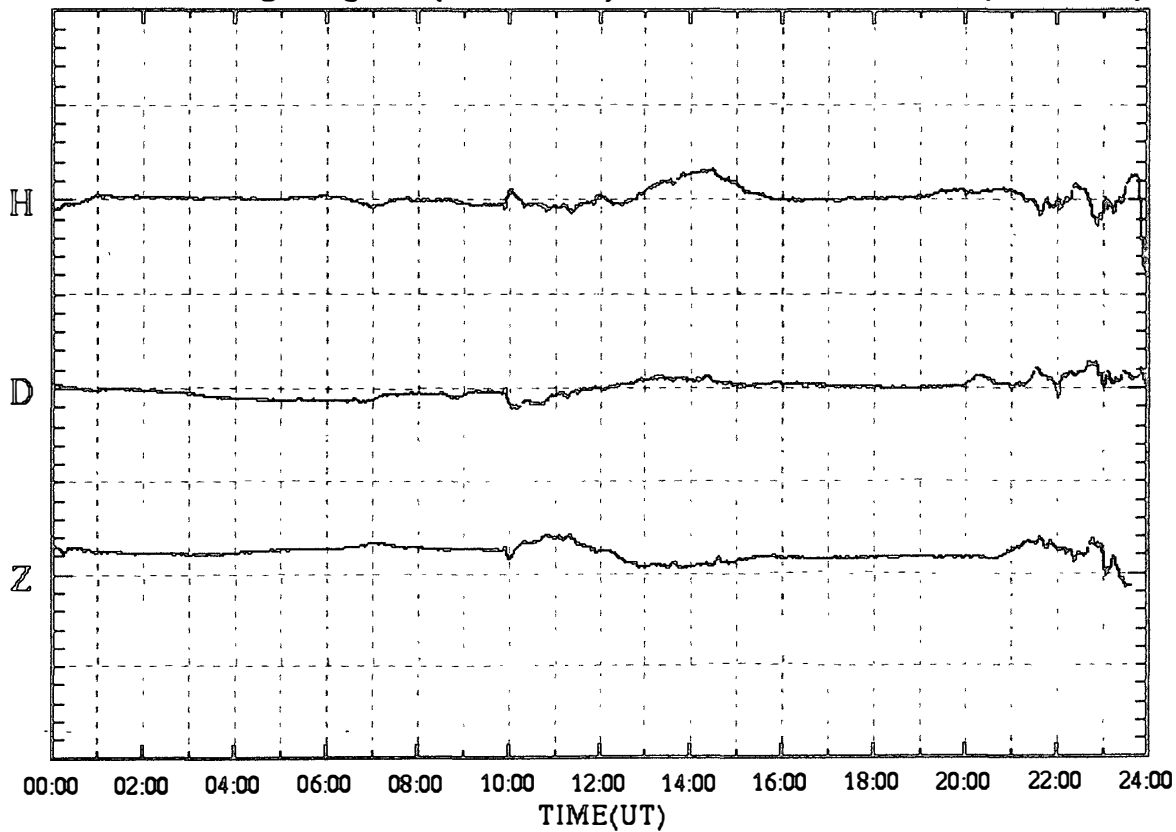

SYOWA magnetogram (100 nT/div)

29 Oct.2000 (DAY:303)

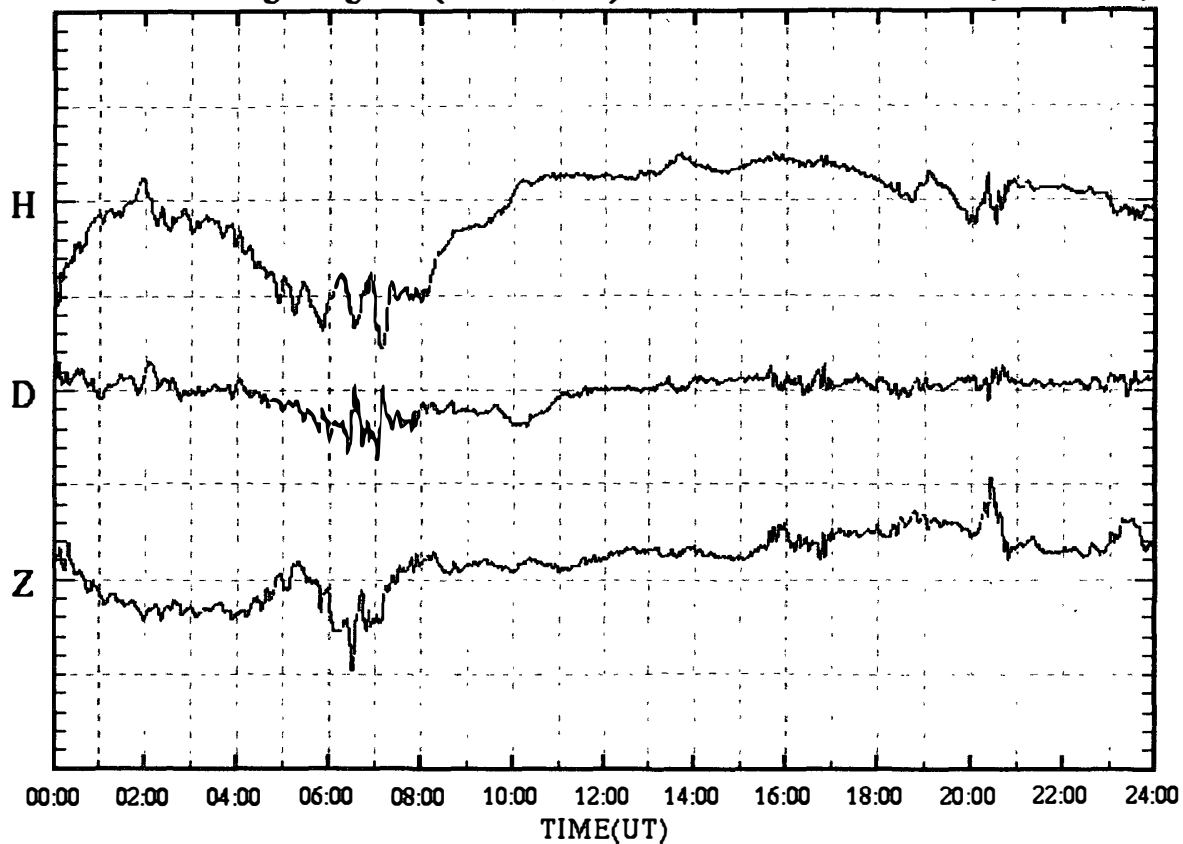

SYOWA magnetogram (100 nT/div)

30 Oct.2000 (DAY:304)

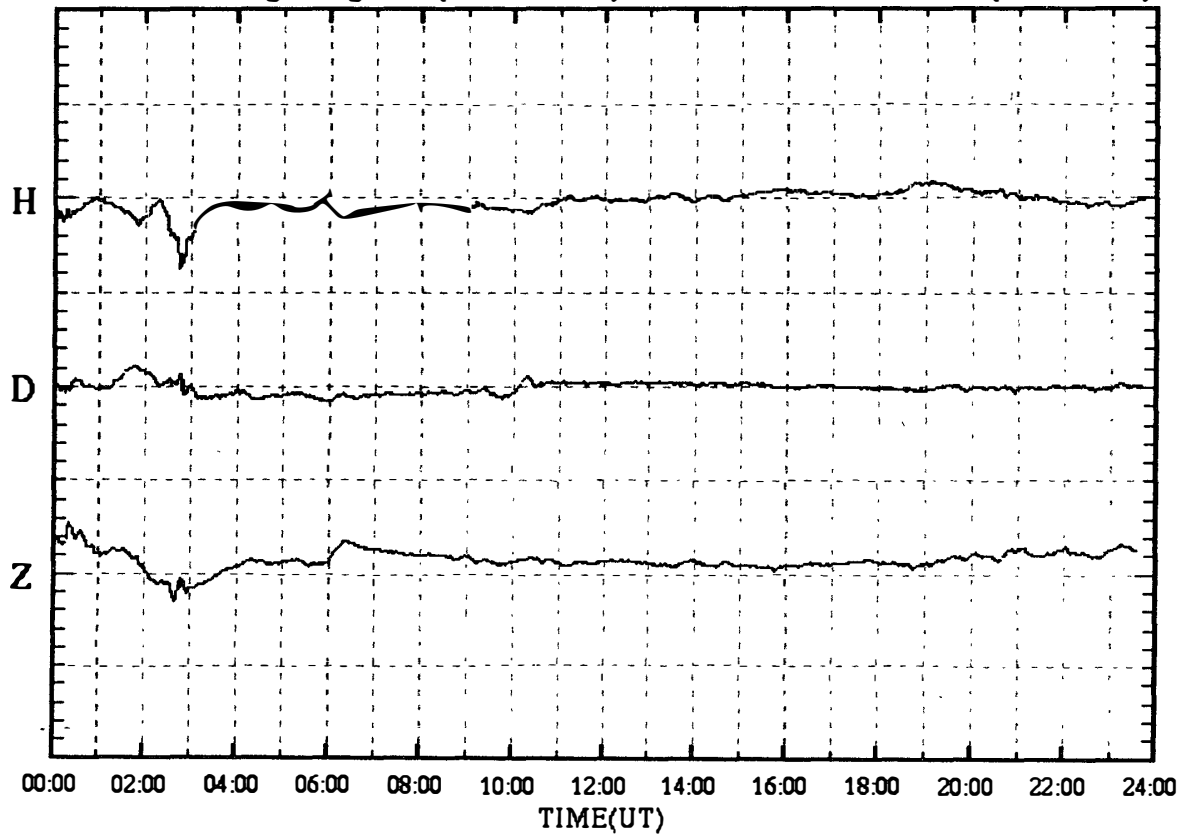

SYOWA magnetogram (100 nT/div)

31 Oct.2000 (DAY:305)

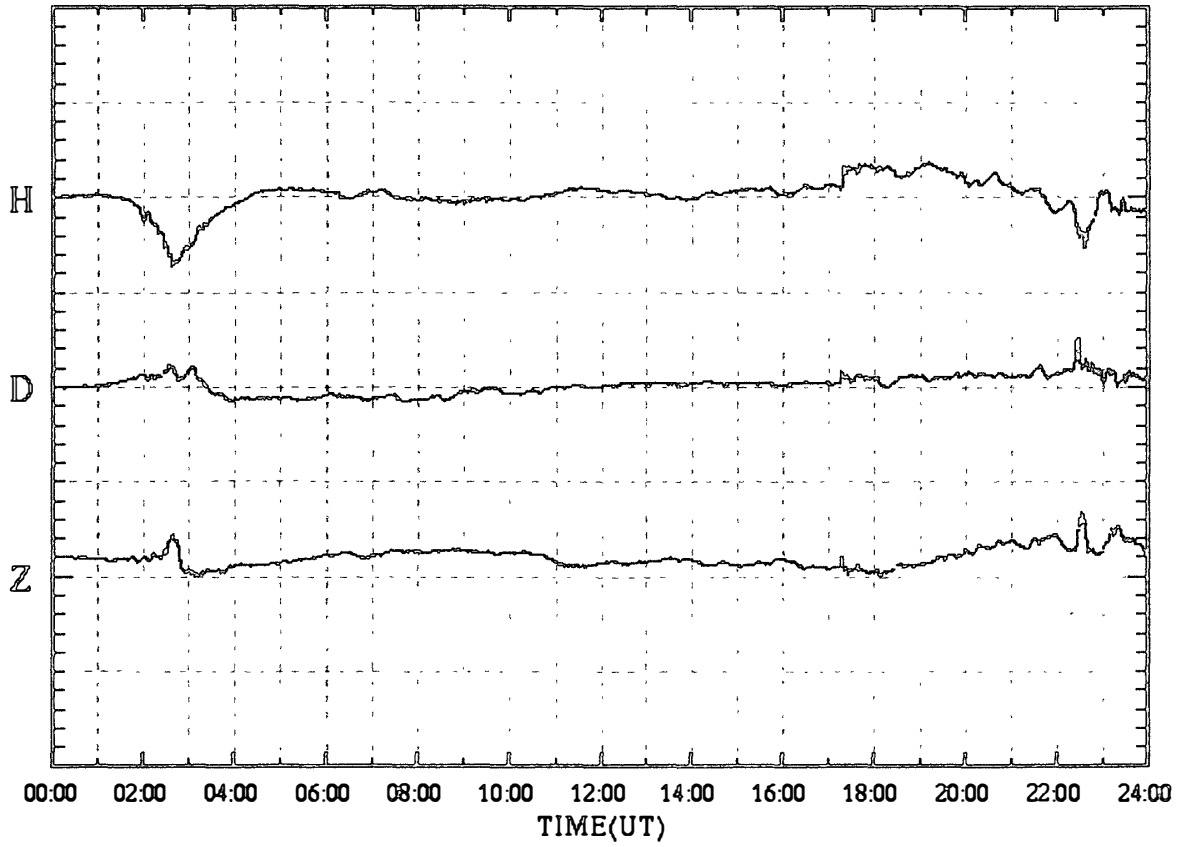

SYOWA magnetogram (100 nT/div)

01 Nov.2000 (DAY:306)

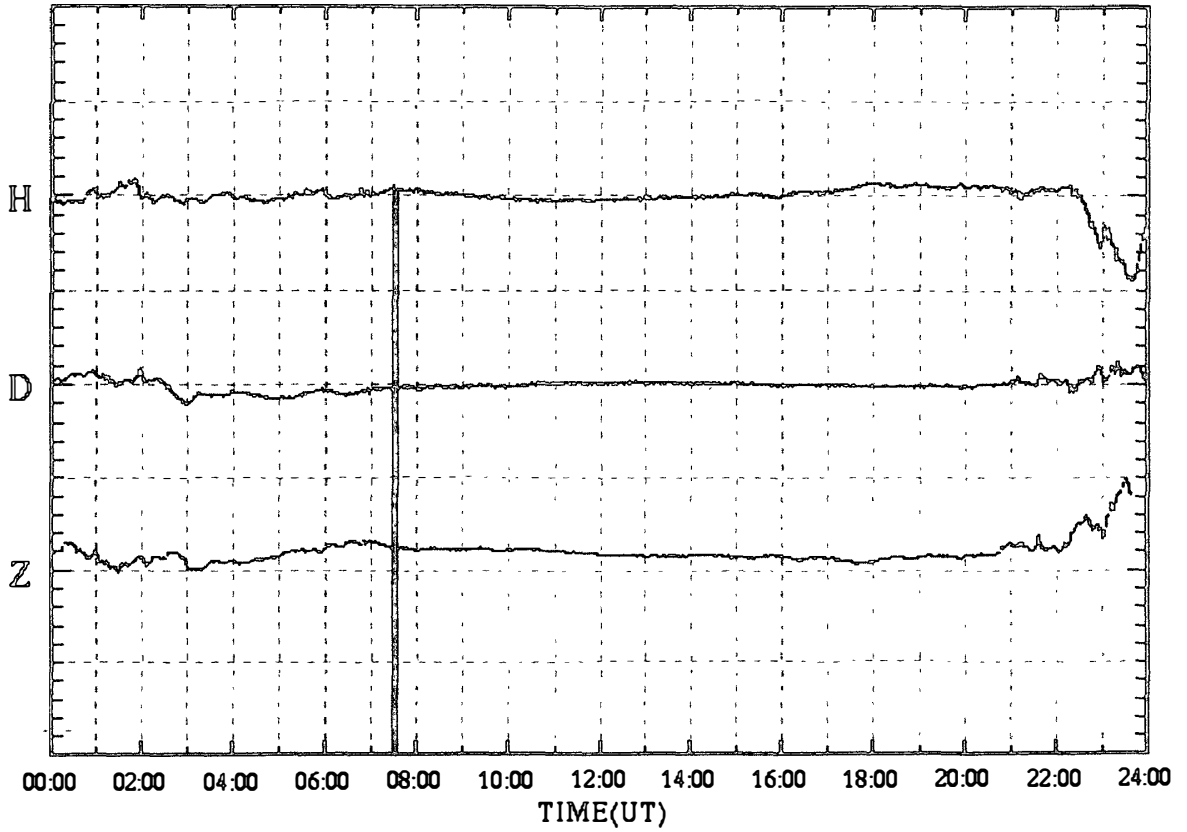

SYOWA magnetogram (100 nT/div)

02 Nov.2000 (DAY:307)

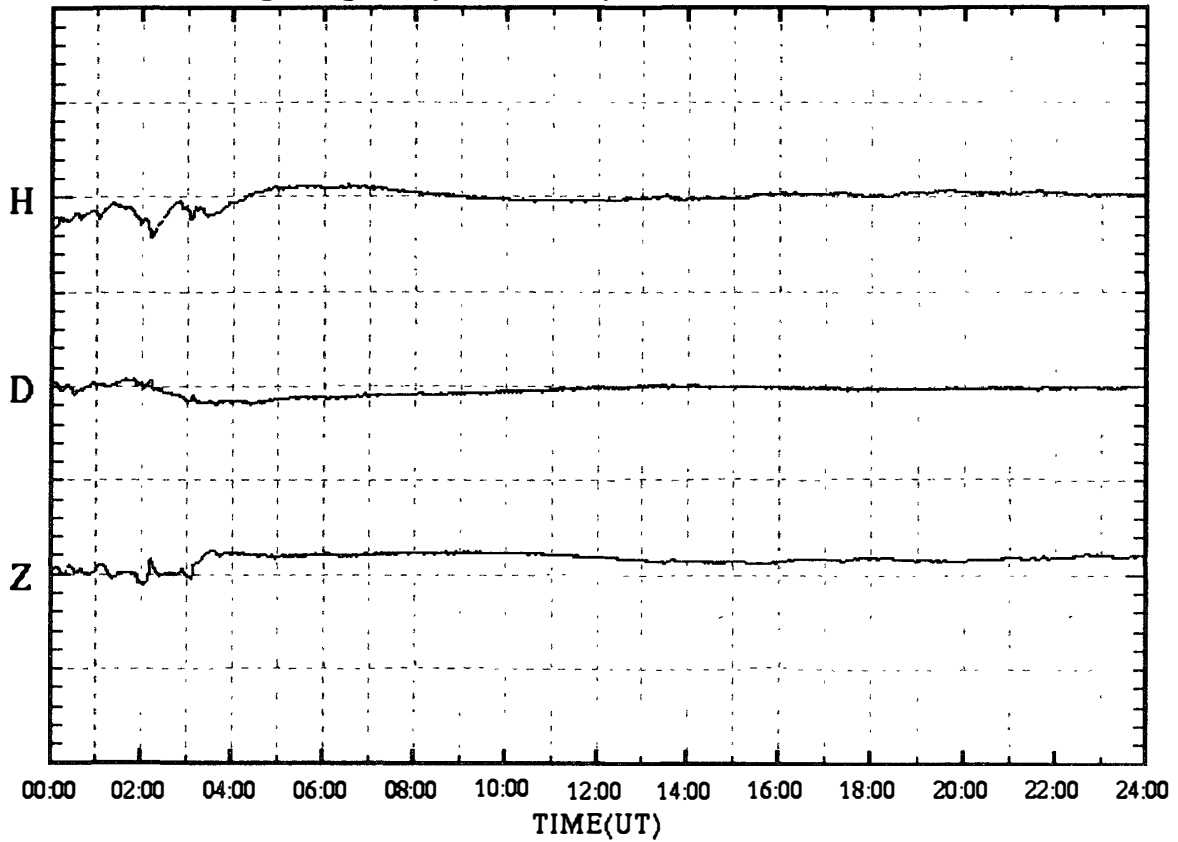

SYOWA magnetogram (100 nT/div)

03 Nov.2000 (DAY:308)

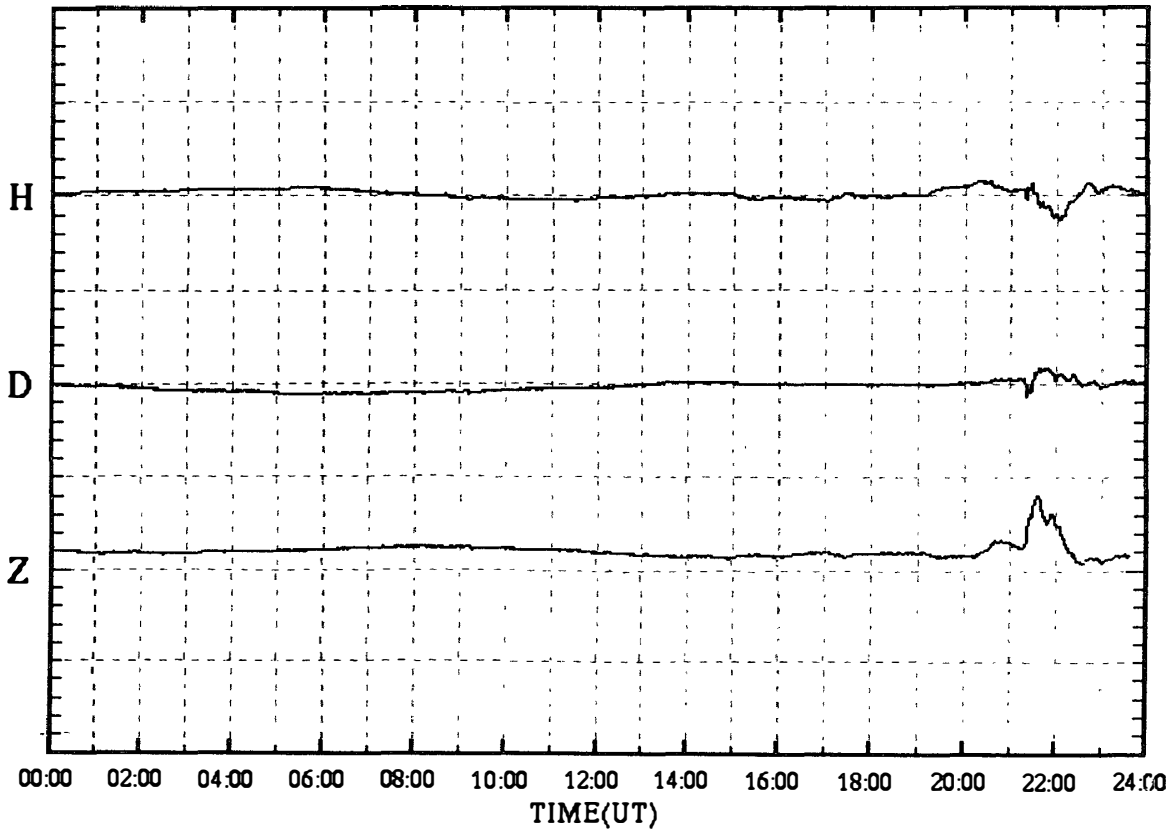

SYOWA magnetogram (100 nT/div)

04 Nov.2000 (DAY:309)

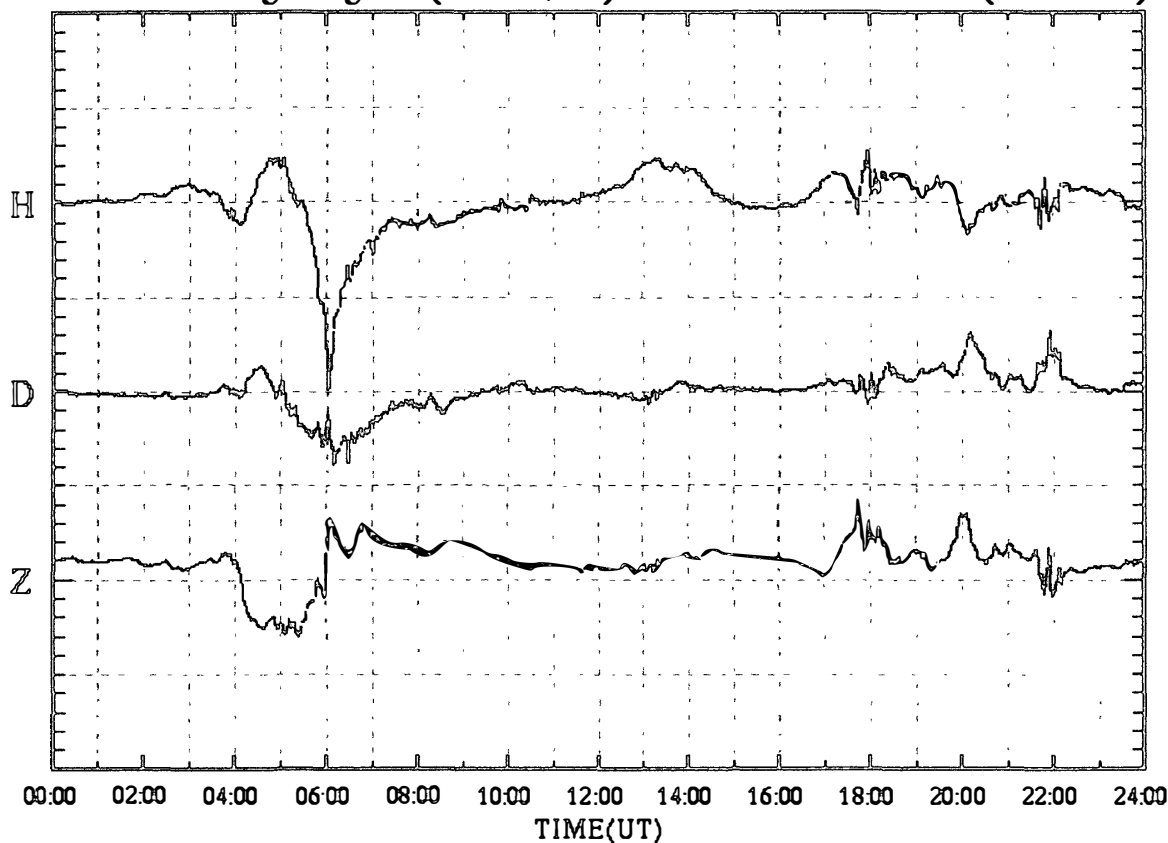

SYOWA magnetogram (100 nT/div)

05 Nov.2000 (DAY:310)

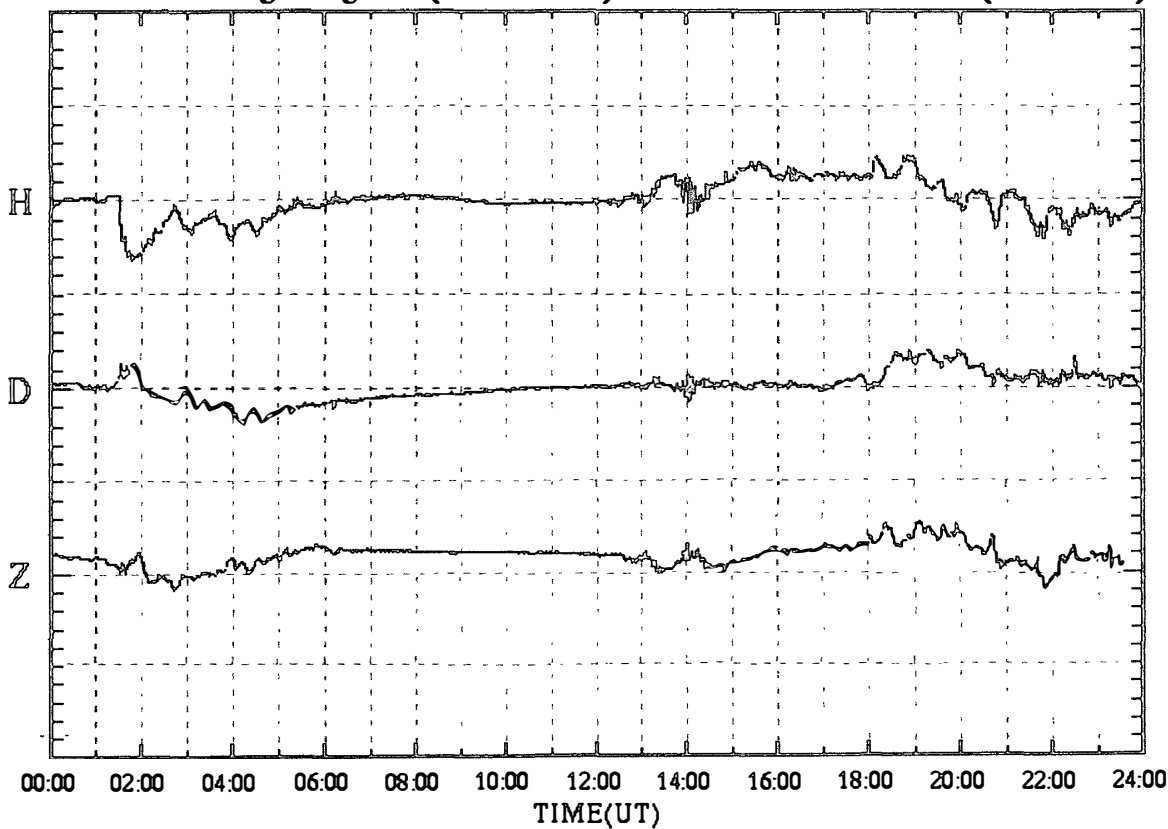

SYOWA magnetogram (100 nT/div)

06 Nov.2000 (DAY:311)

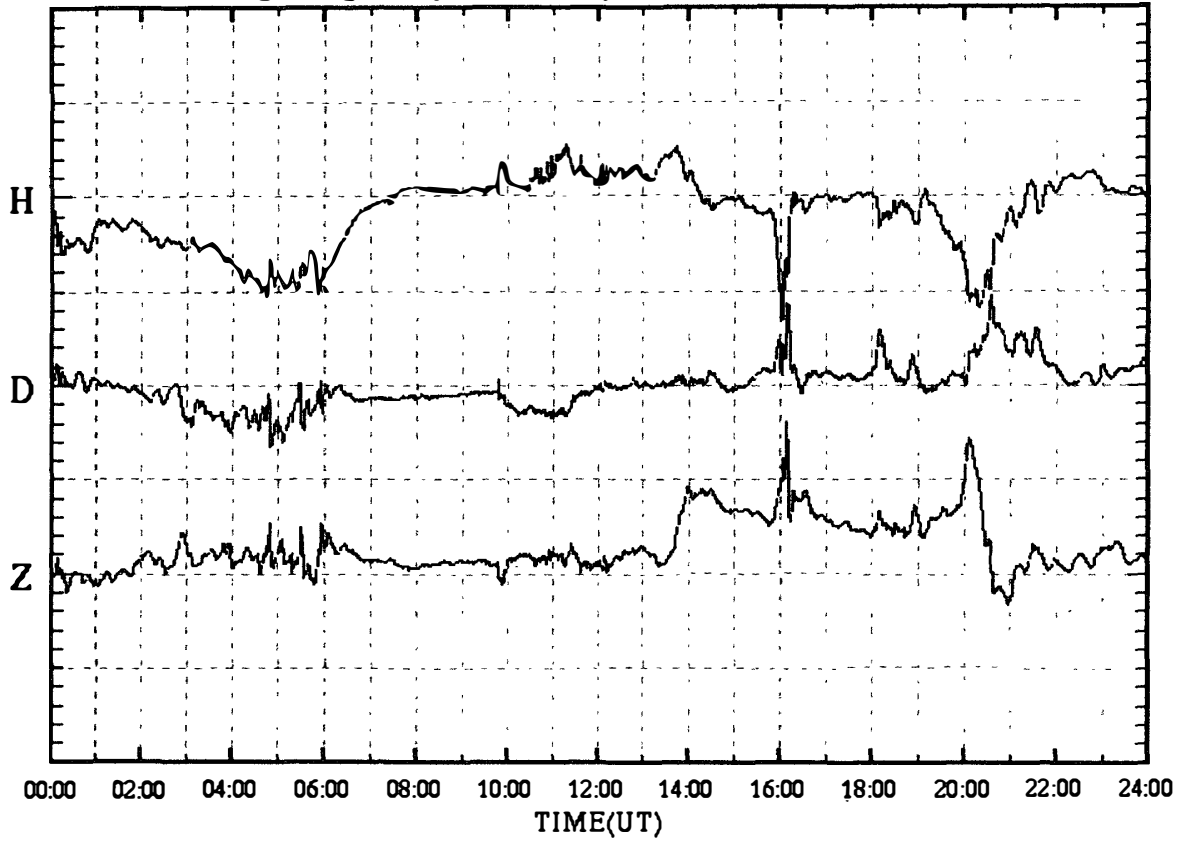

SYOWA magnetogram (100 nT/div)

07 Nov.2000 (DAY:312)

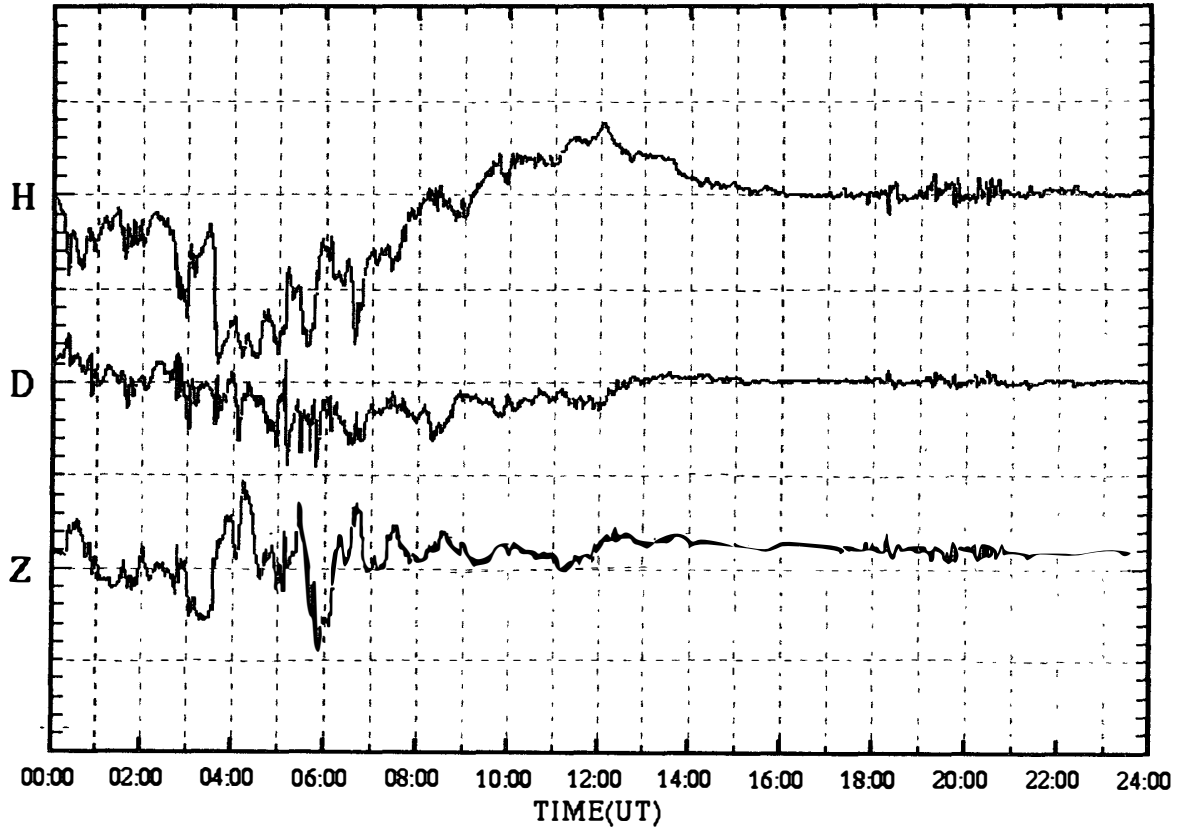

SYOWA magnetogram (100 nT/div)

08 Nov.2000 (DAY:313)

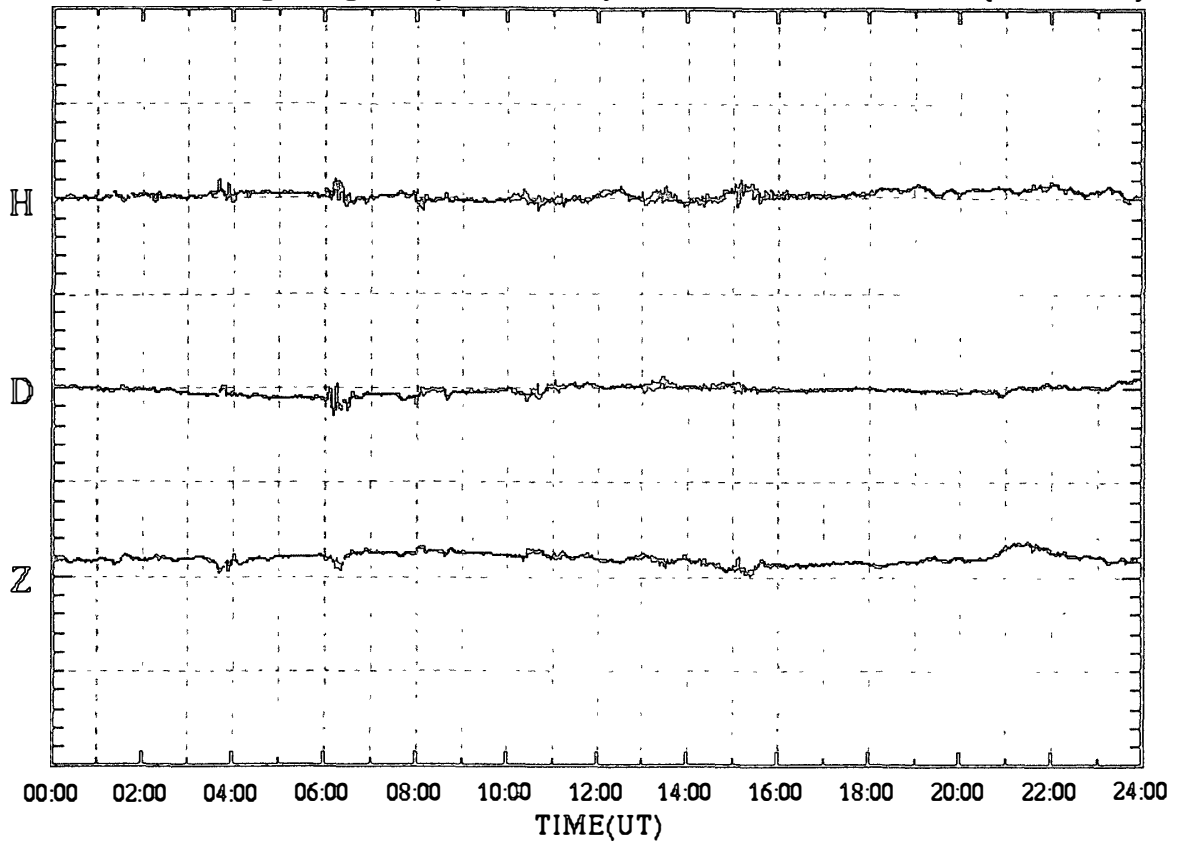

SYOWA magnetogram (100 nT/div)

09 Nov.2000 (DAY:314)

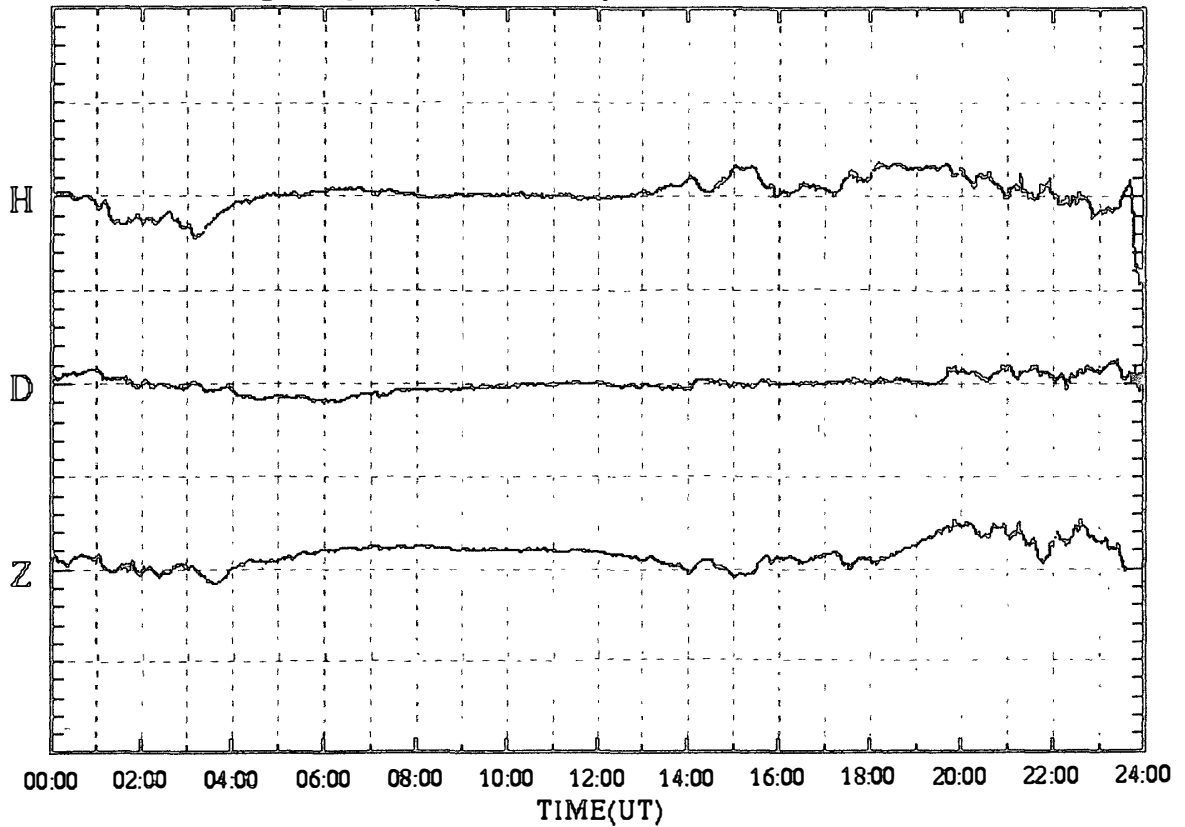

SYOWA magnetogram (100 nT/div)

10 Nov.2000 (DAY:315)

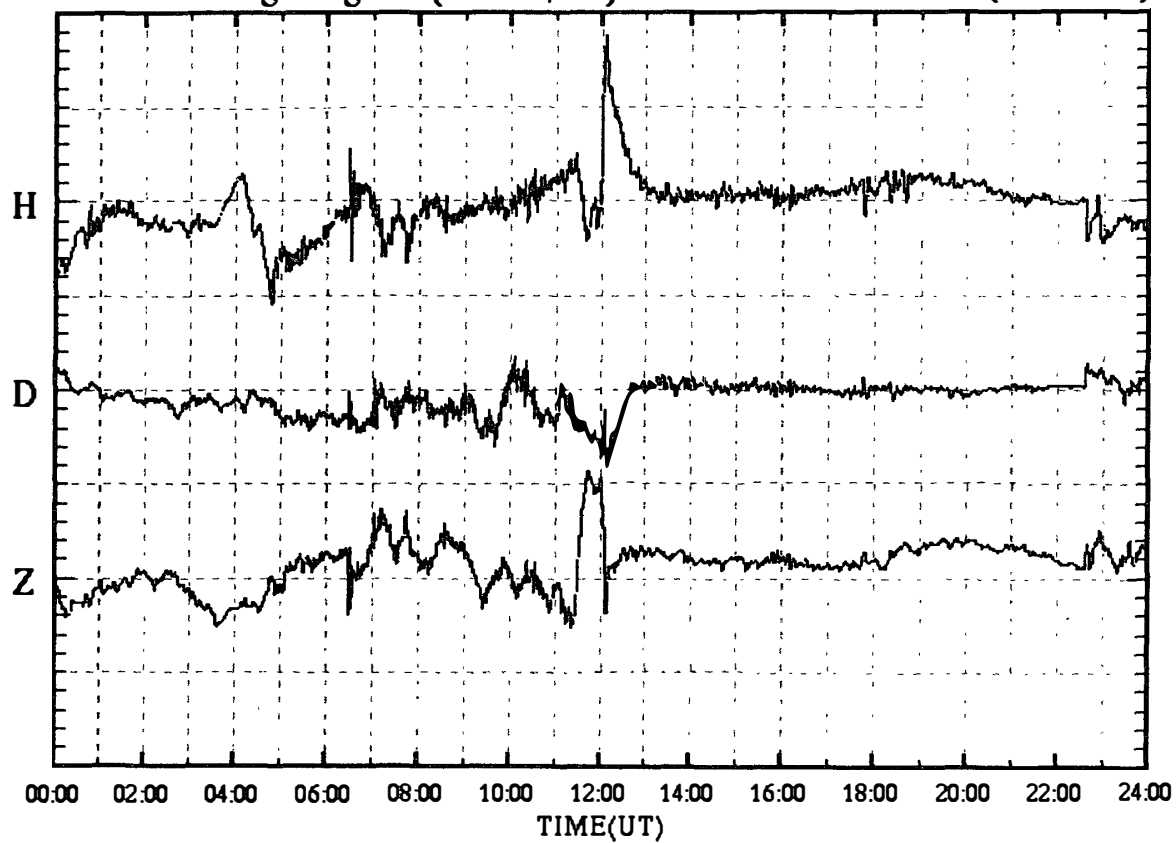

SYOWA magnetogram (100 nT/div)

11 Nov.2000 (DAY:316)

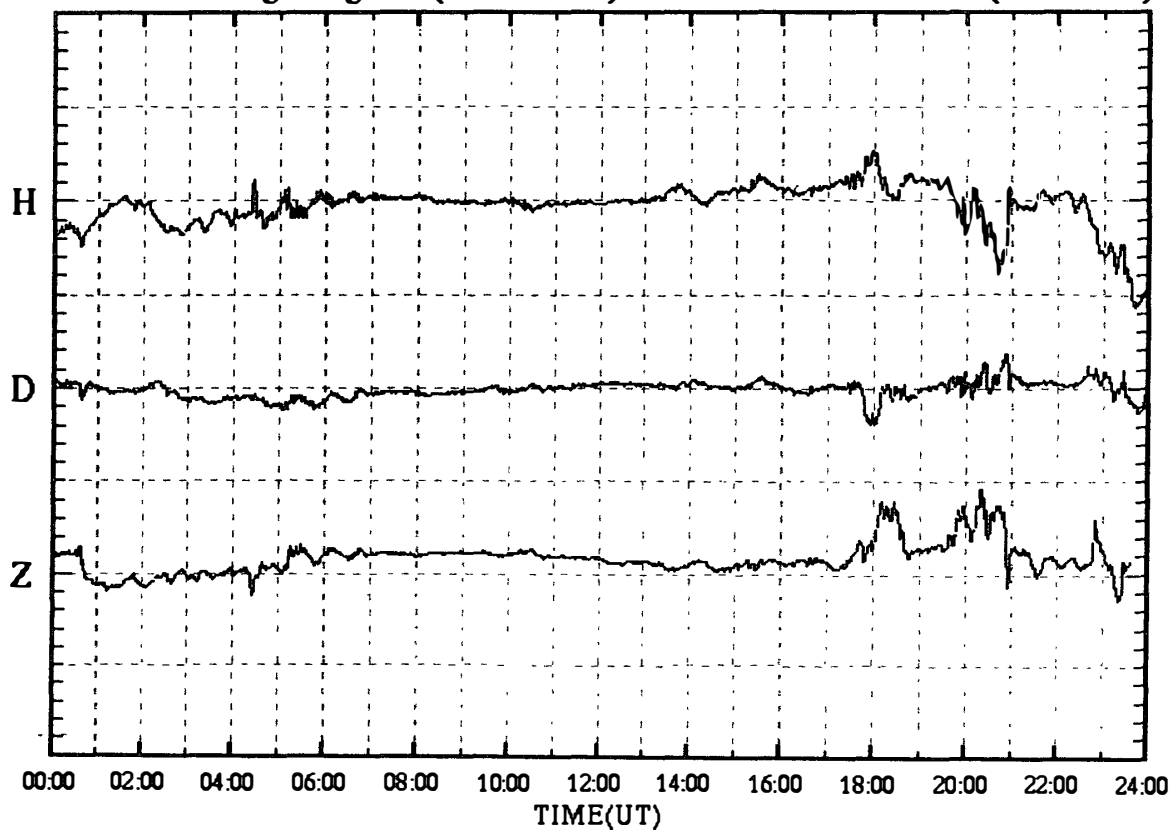

SYOWA magnetogram (100 nT/div)

12 Nov.2000 (DAY:317)

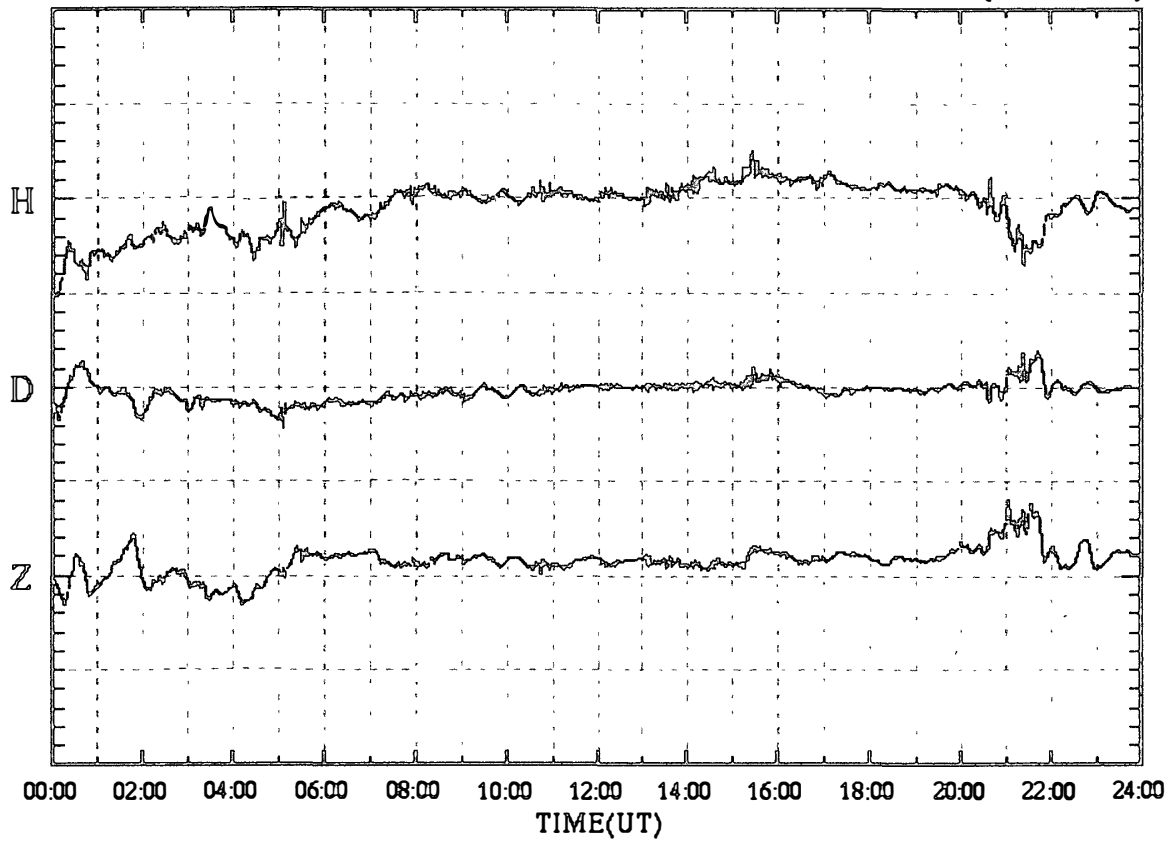

SYOWA magnetogram (100 nT/div)

13 Nov.2000 (DAY:318)

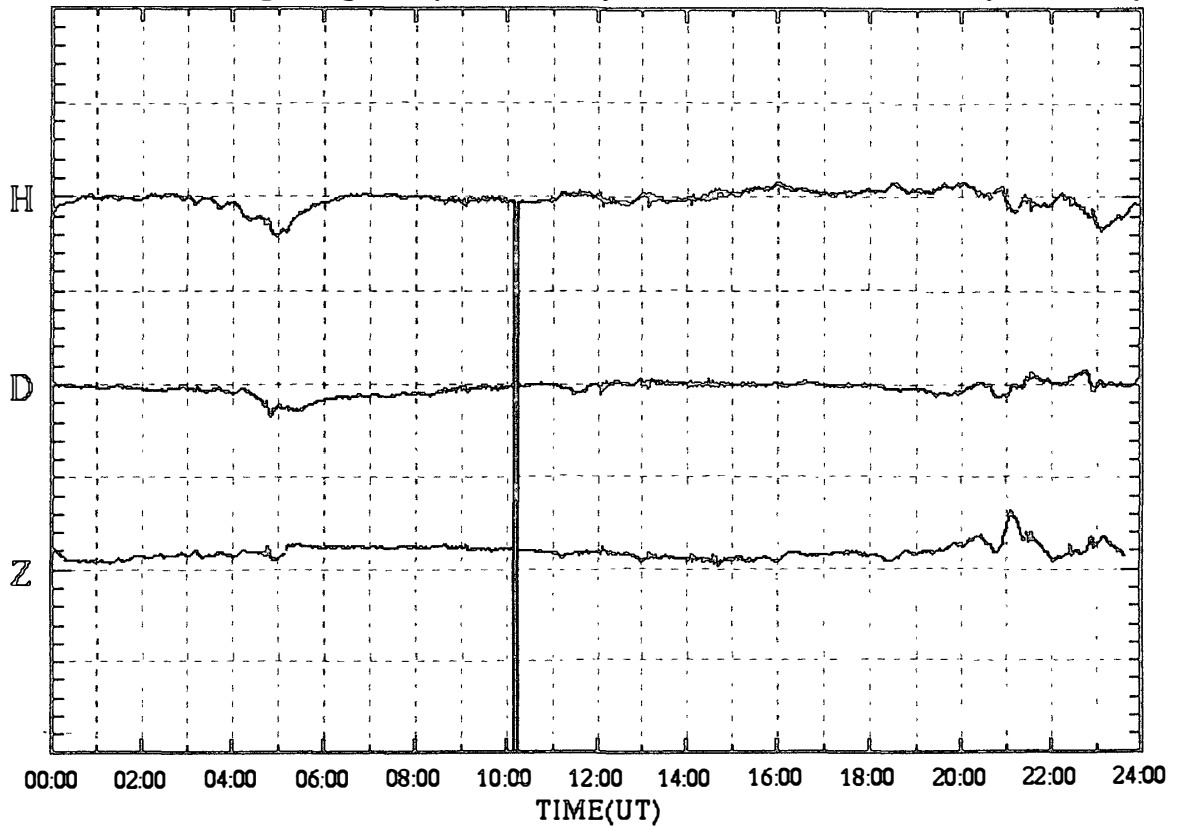

SYOWA magnetogram (100 nT/div)

14 Nov.2000 (DAY:319)

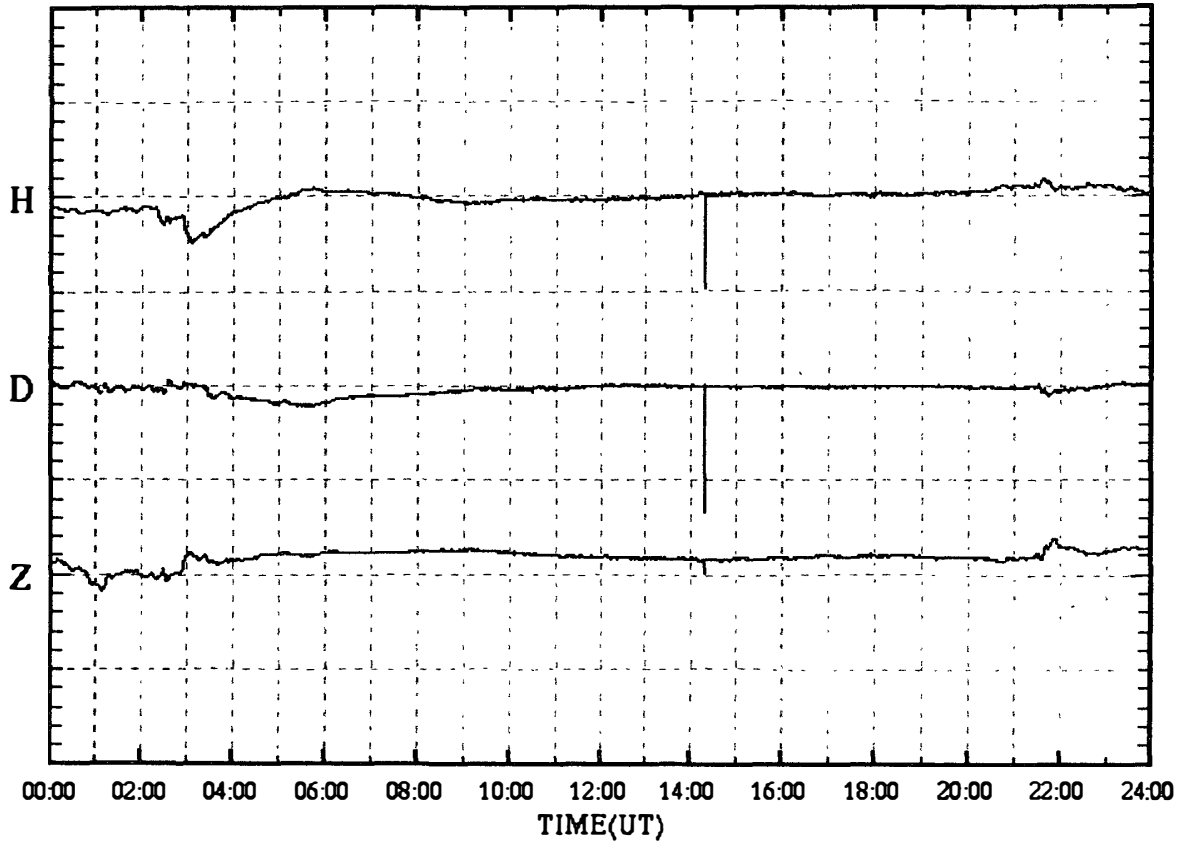

SYOWA magnetogram (100 nT/div)

15 Nov.2000 (DAY:320)

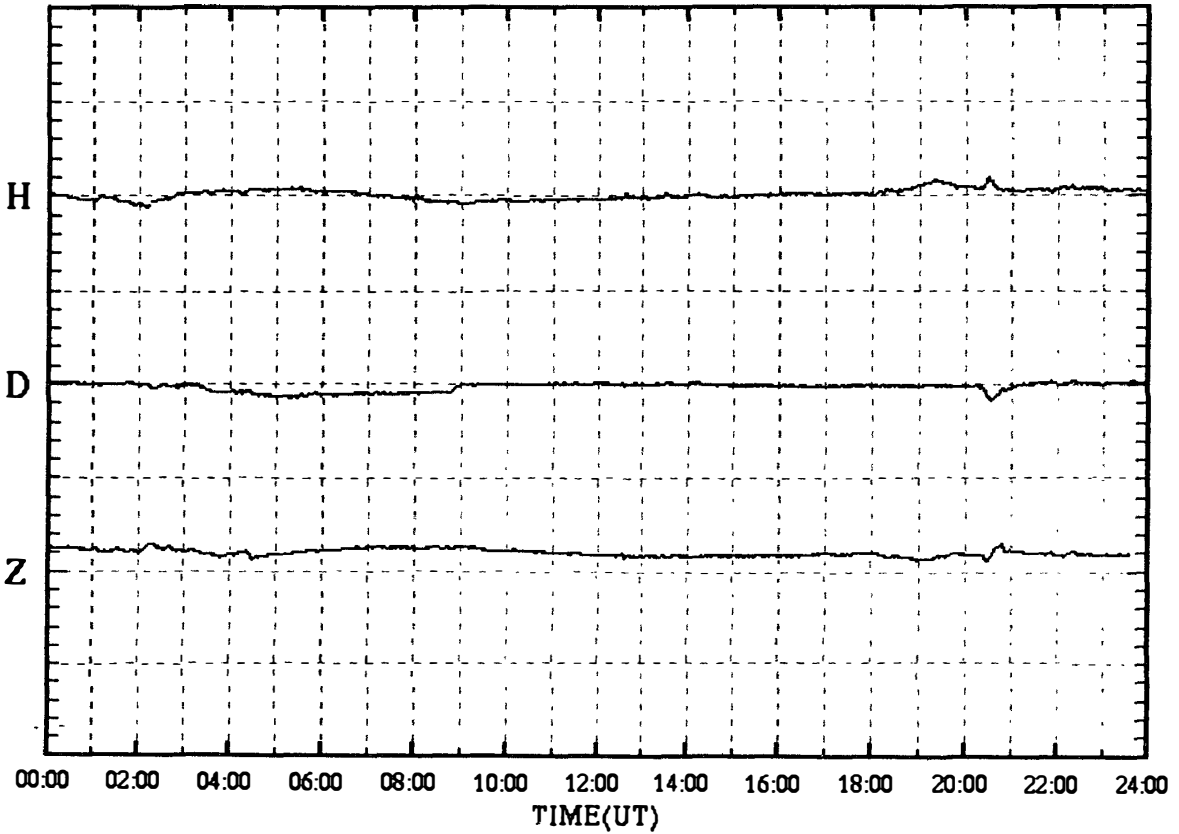

SYOWA magnetogram (100 nT/div)

16 Nov.2000 (DAY:321)

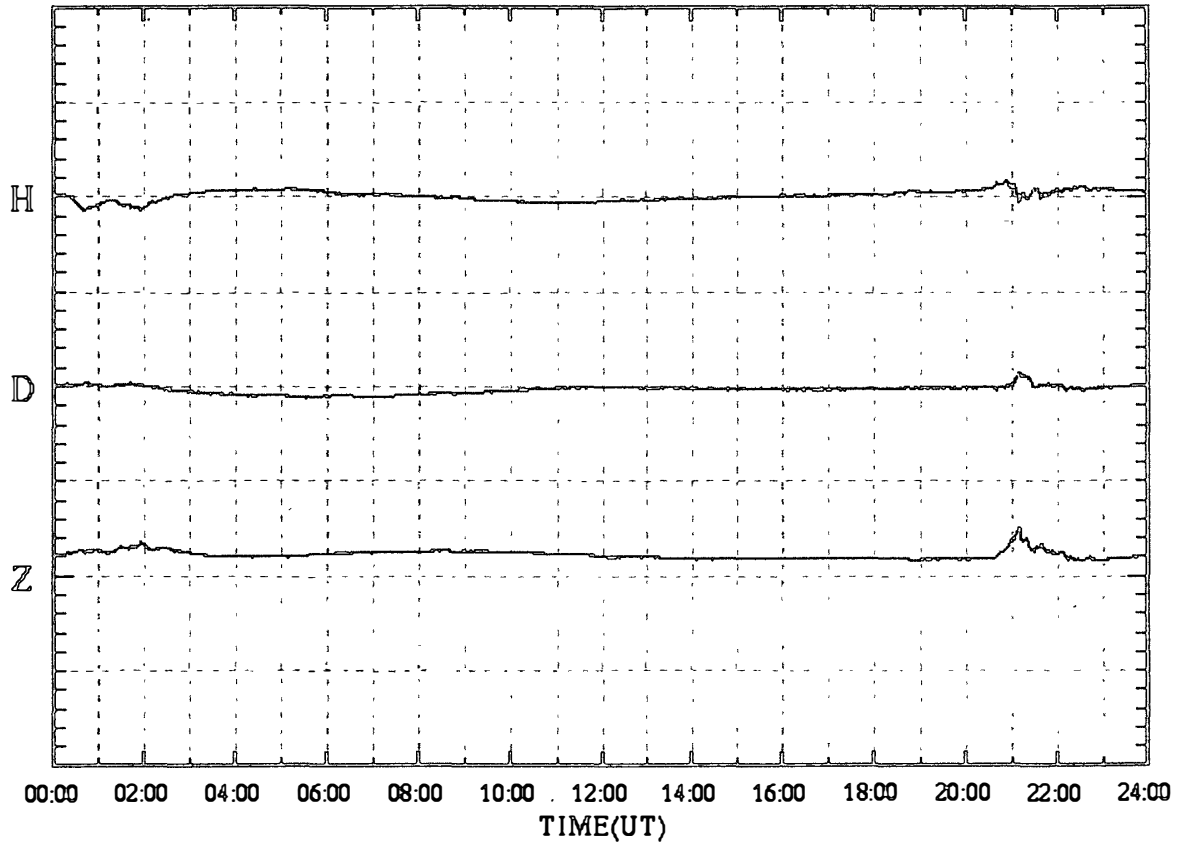

SYOWA magnetogram (100 nT/div)

17 Nov.2000 (DAY:322)

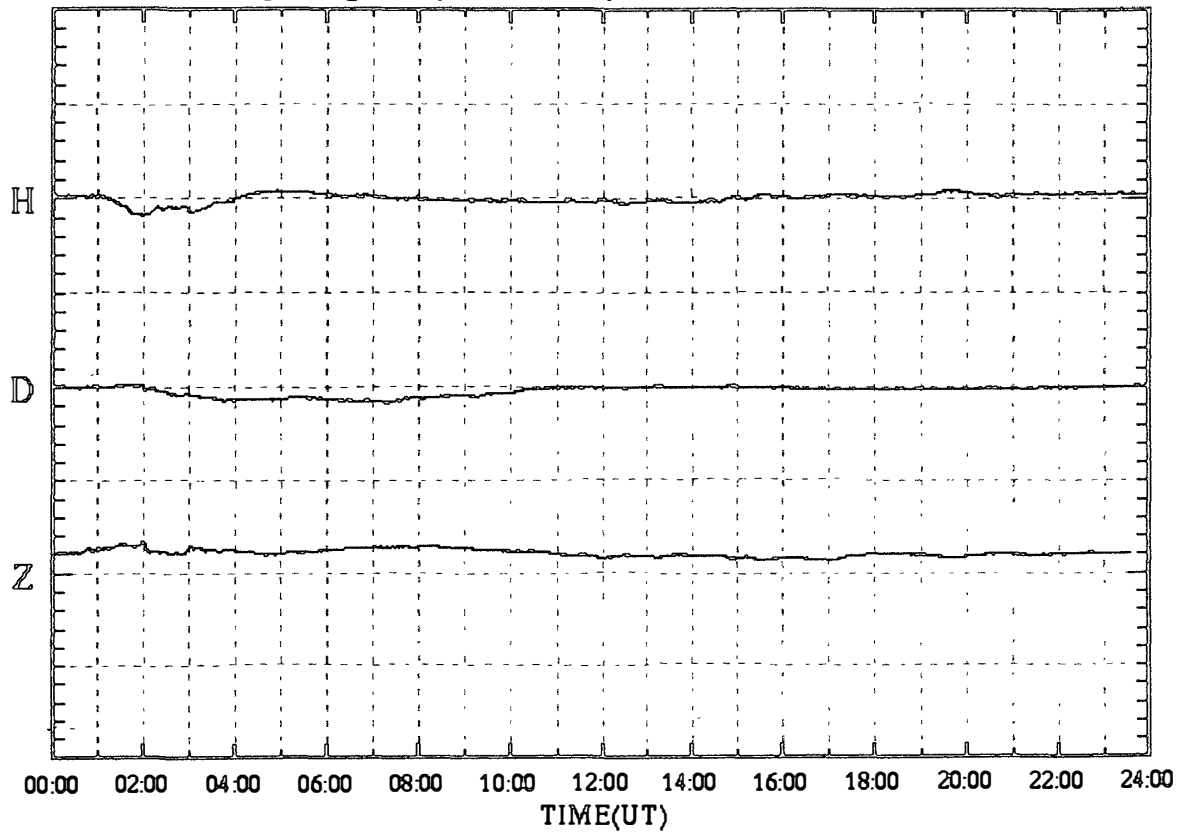

SYOWA magnetogram (100 nT/div)

18 Nov.2000 (DAY:323)

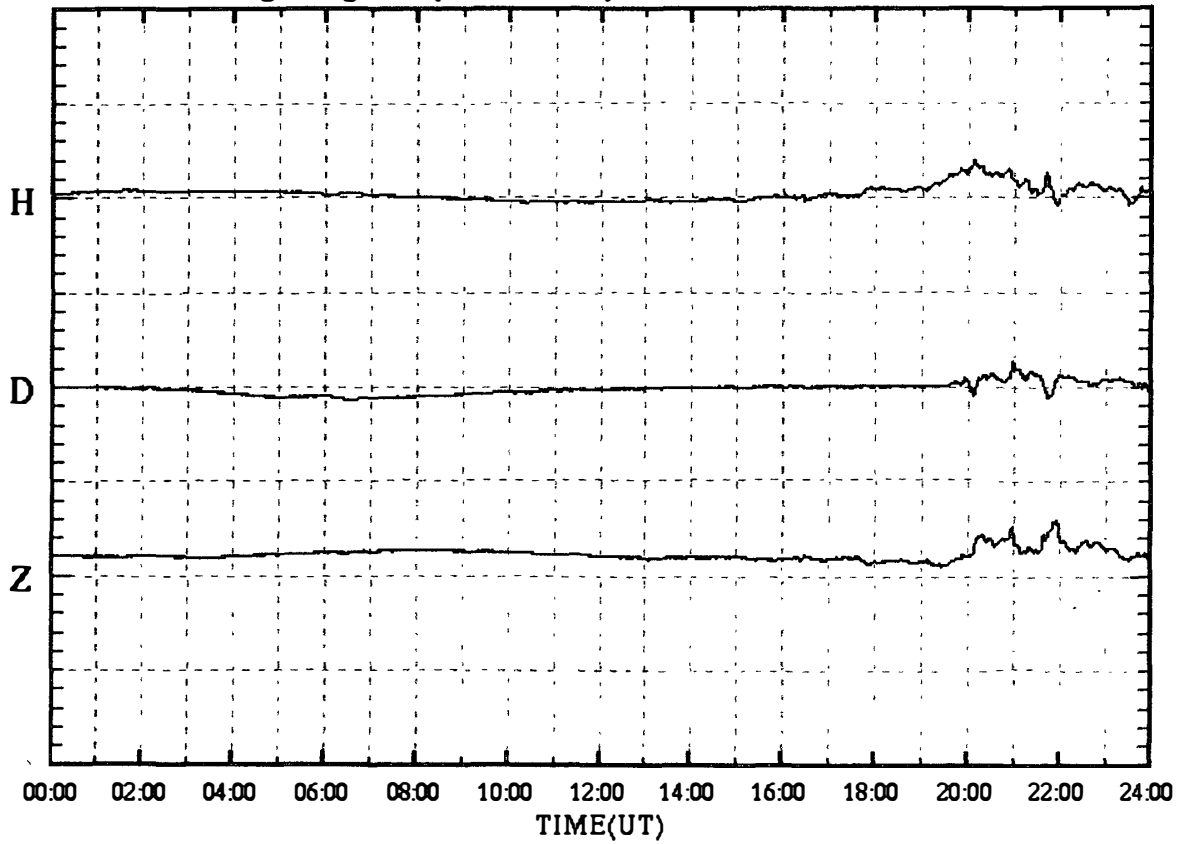

SYOWA magnetogram (100 nT/div)

19 Nov.2000 (DAY:324)

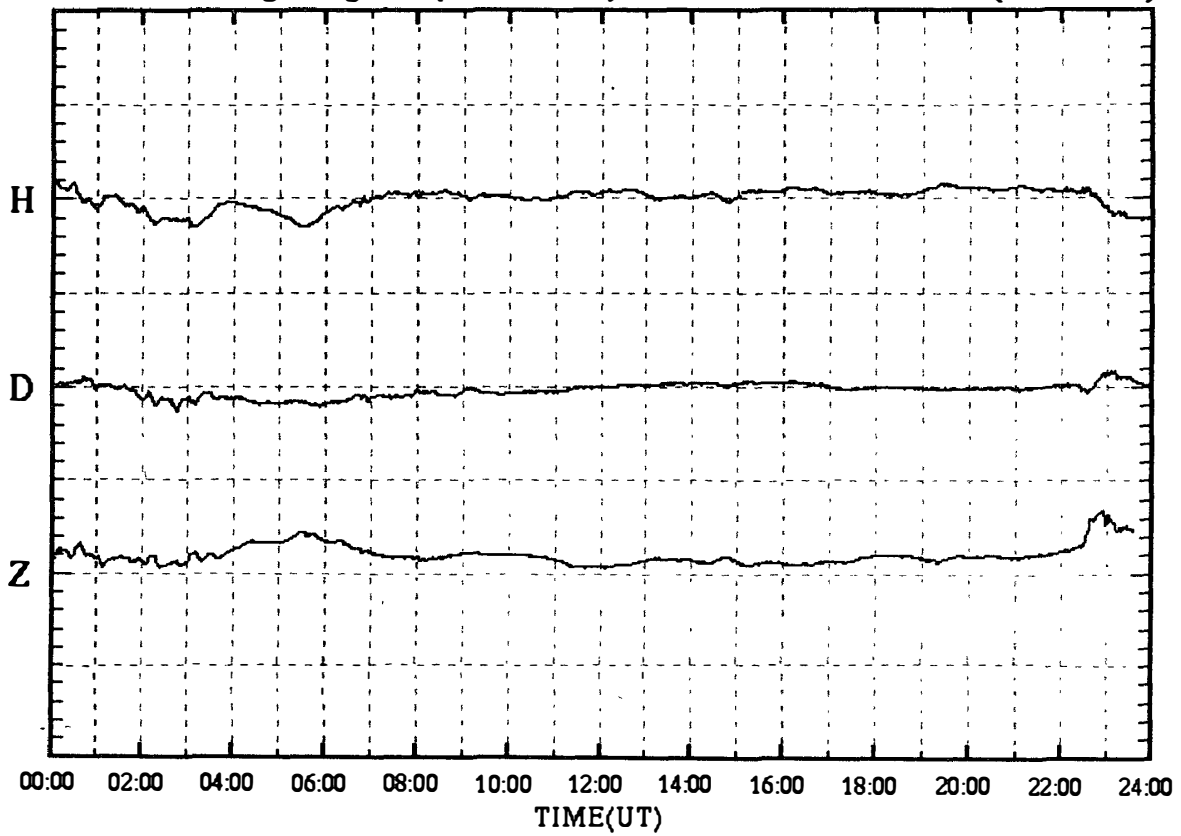

SYOWA magnetogram (100 nT/div)

20 Nov.2000 (DAY:325)

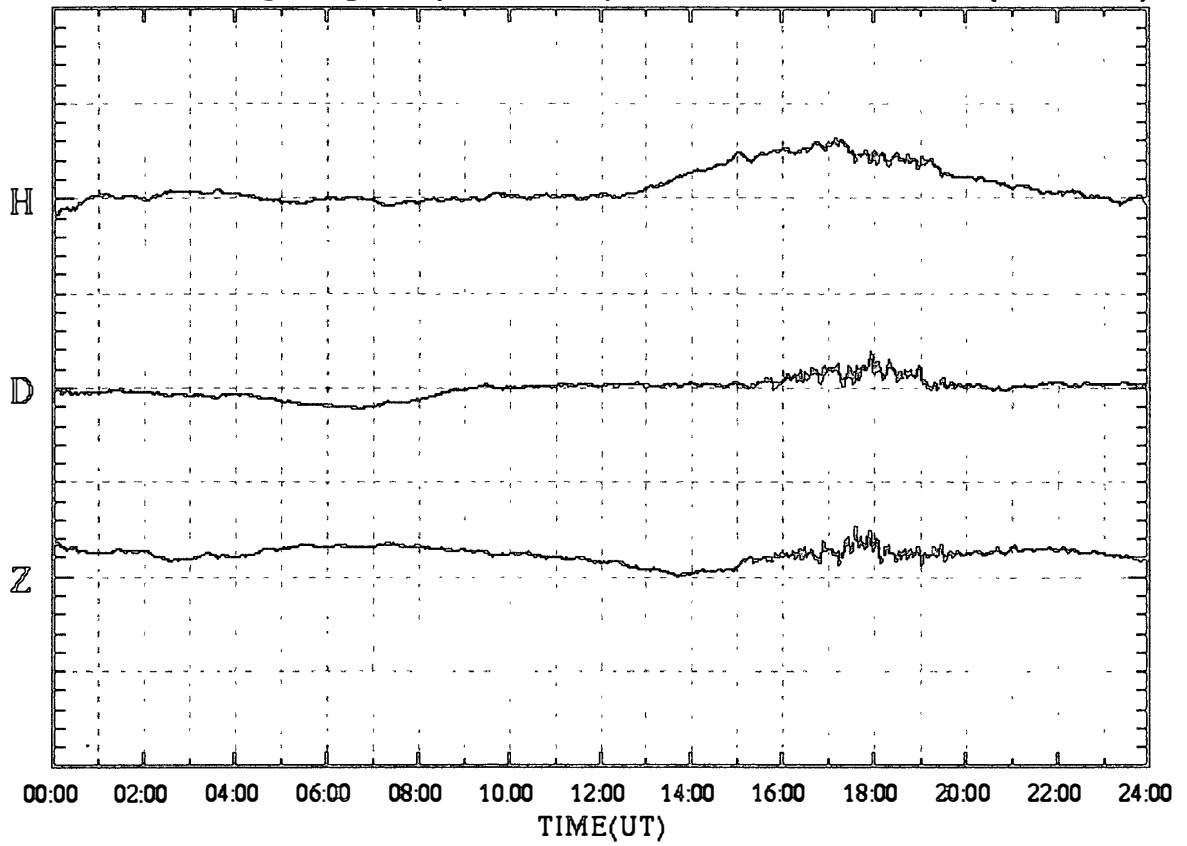

SYOWA magnetogram (100 nT/div)

21 Nov.2000 (DAY:326)

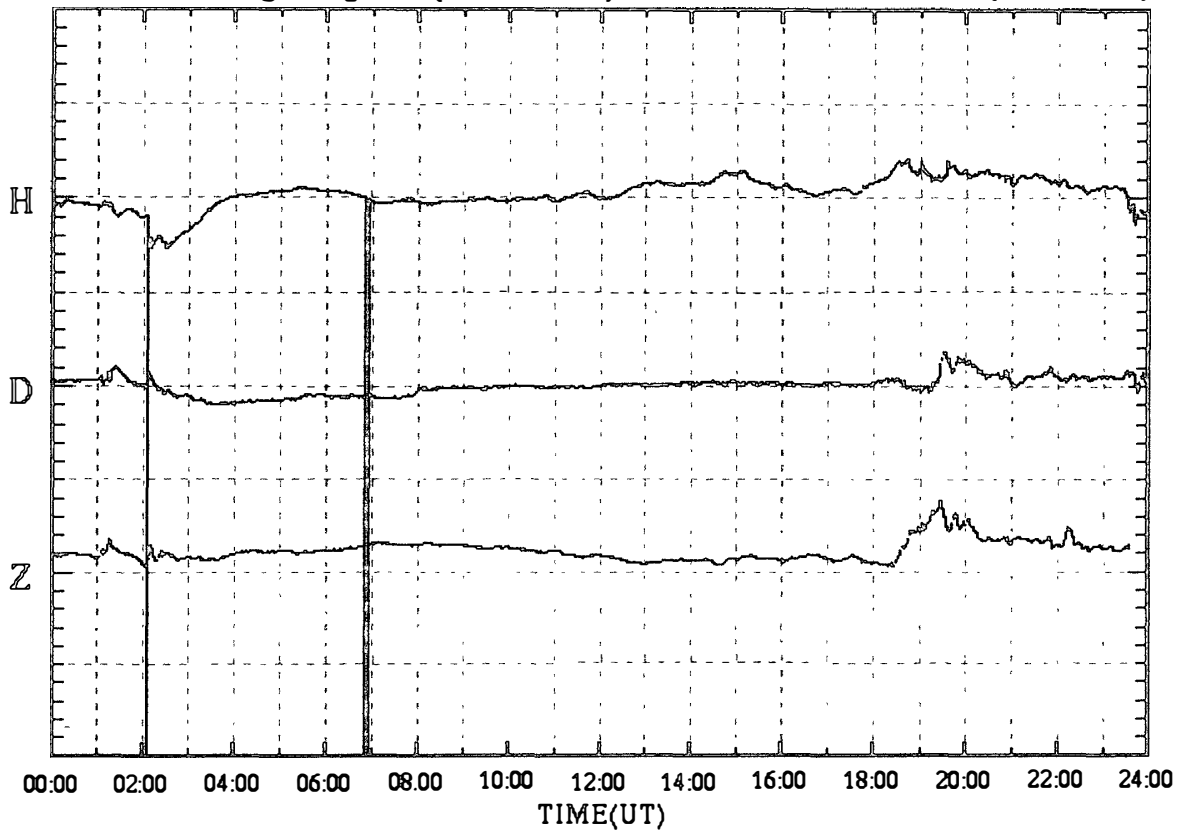

SYOWA magnetogram (100 nT/div)

22 Nov.2000 (DAY:327)

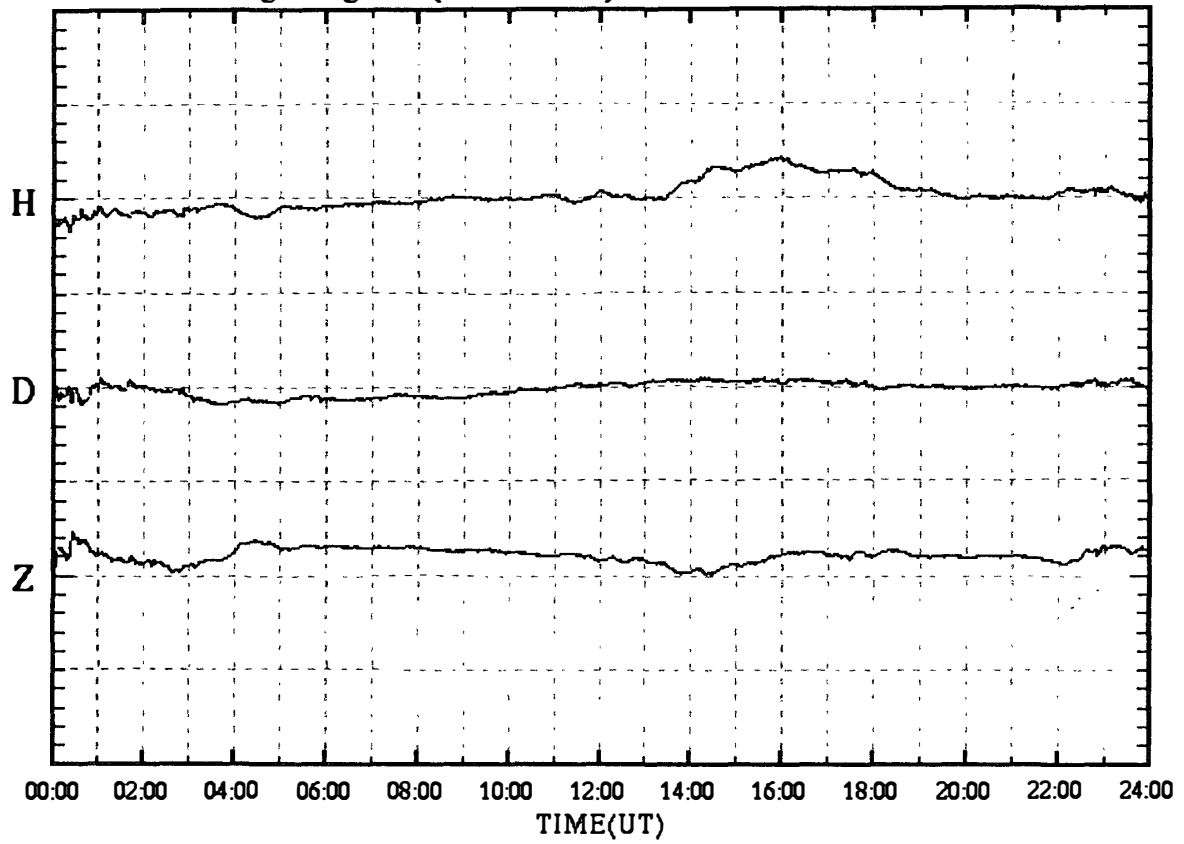

SYOWA magnetogram (100 nT/div)

23 Nov.2000 (DAY:328)

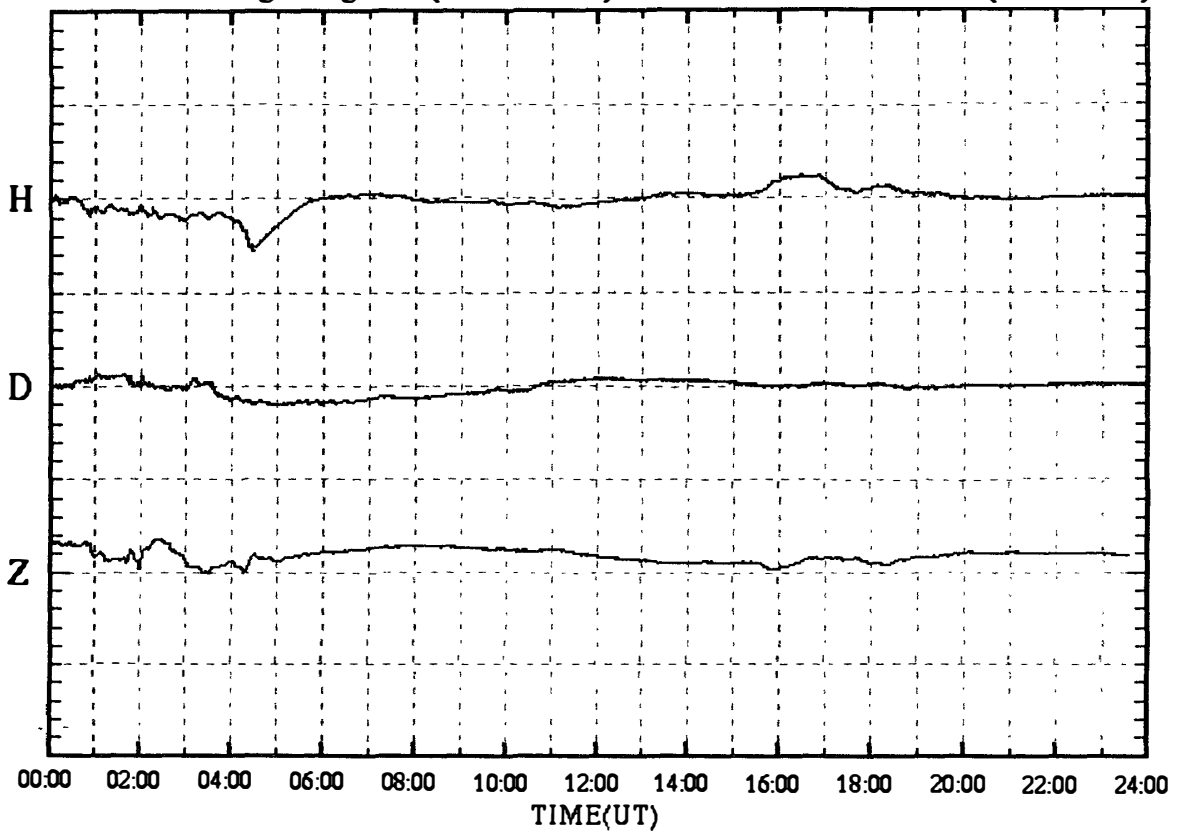

SYOWA magnetogram (100 nT/div)

24 Nov.2000 (DAY:329)

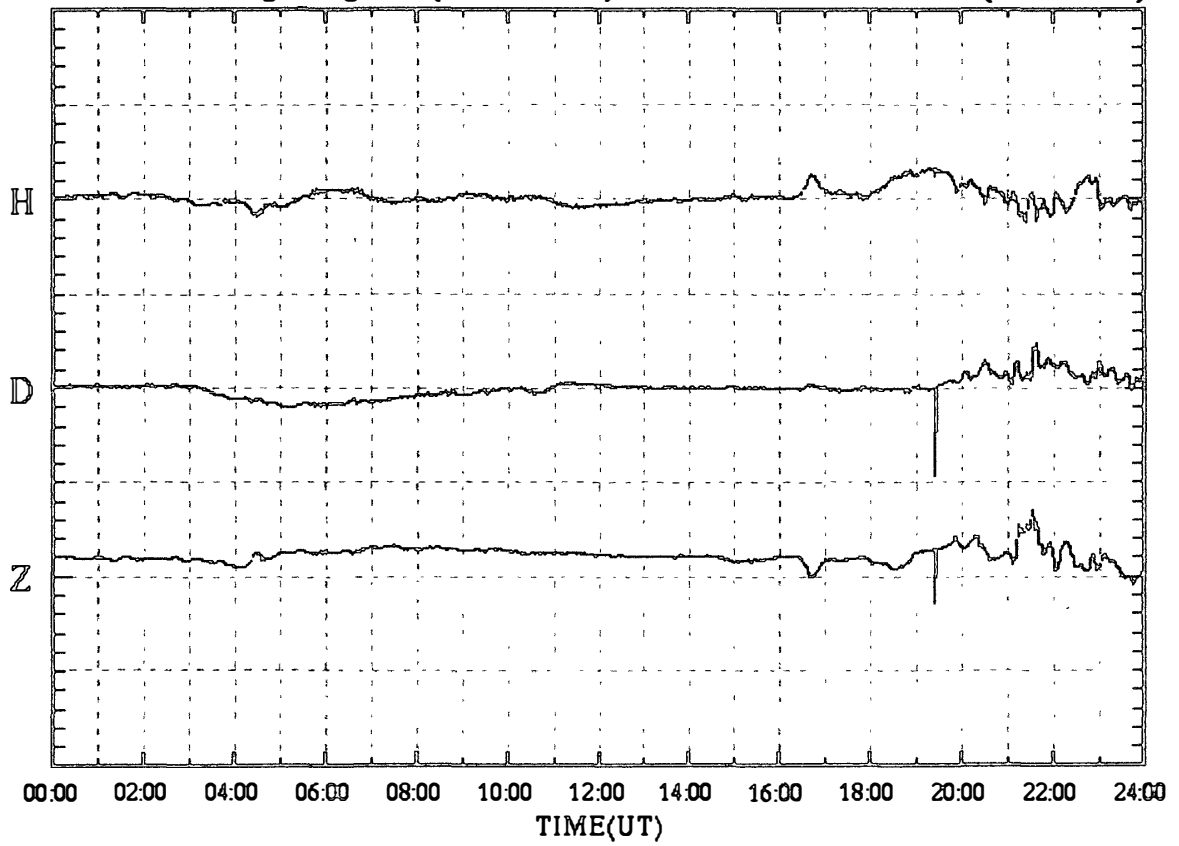

SYOWA magnetogram (100 nT/div)

25 Nov.2000 (DAY:330)

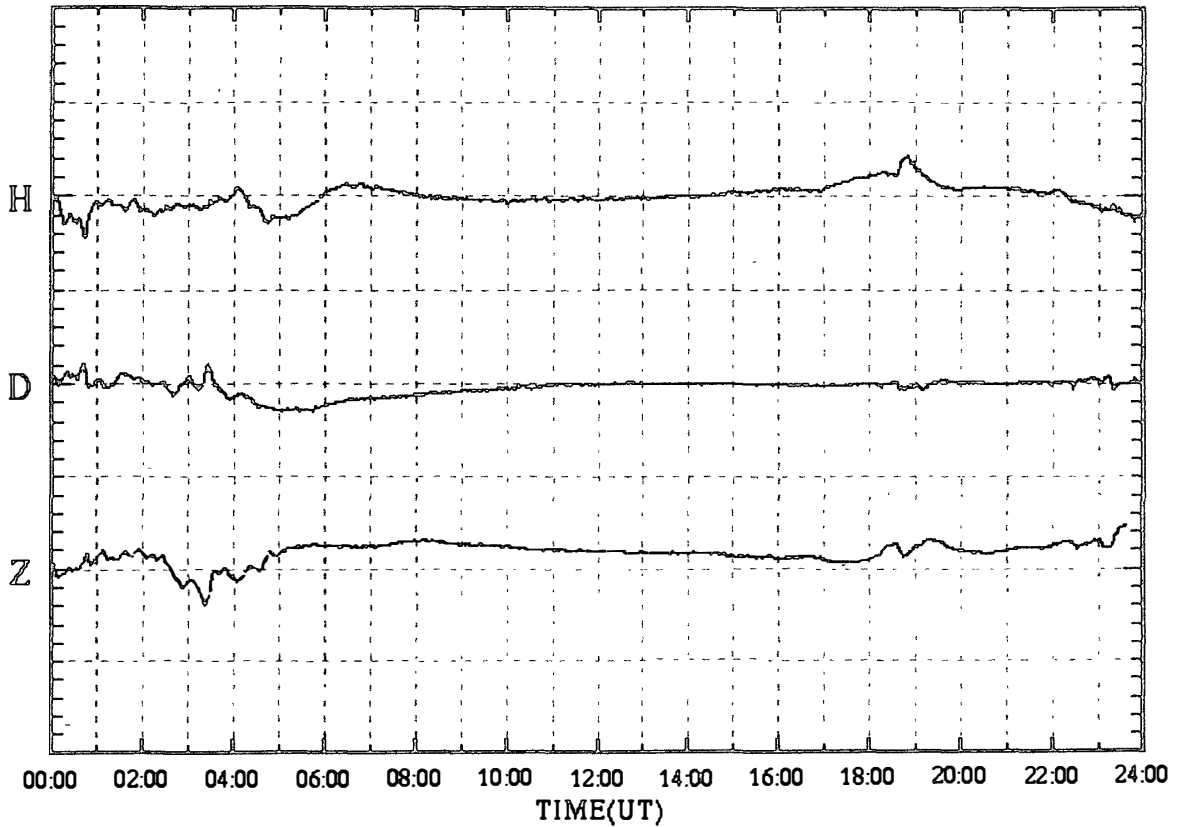

SYOWA magnetogram (100 nT/div)

26 Nov.2000 (DAY:331)

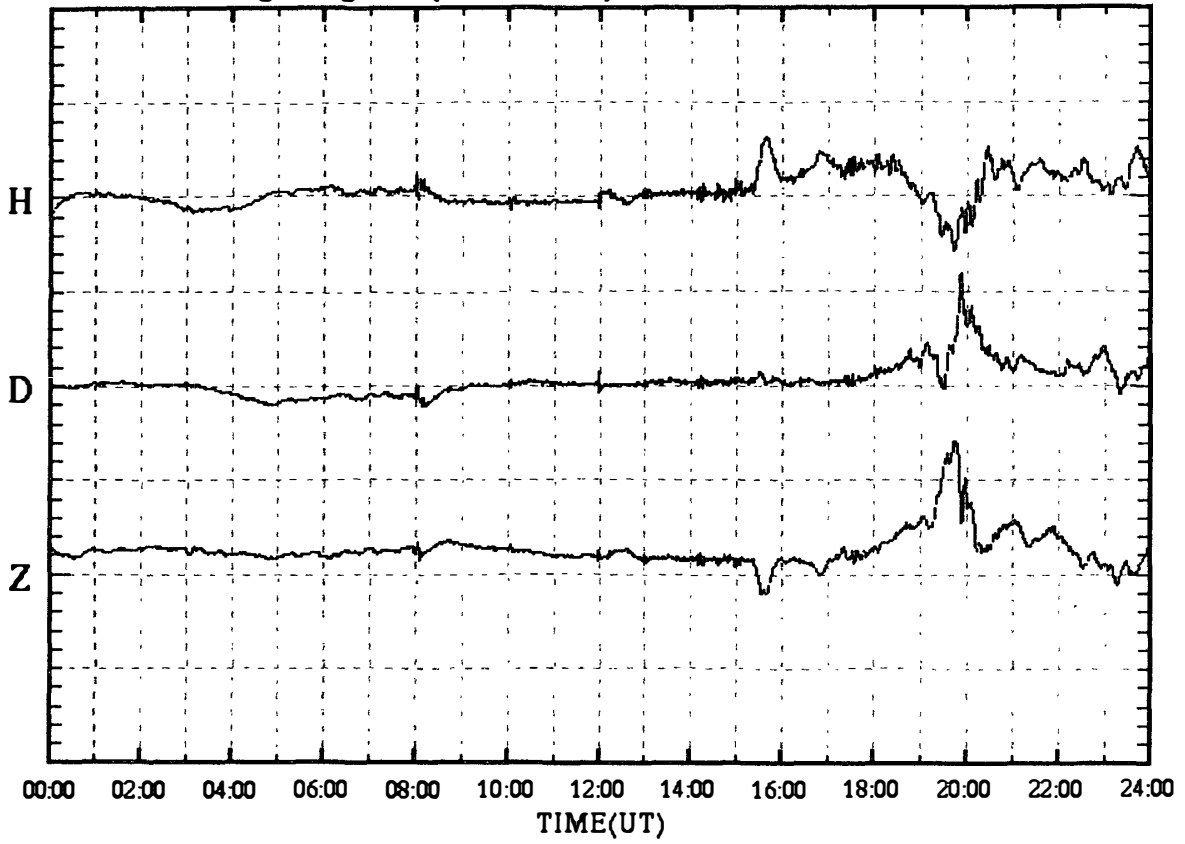

SYOWA magnetogram (100 nT/div)

27 Nov.2000 (DAY:332)

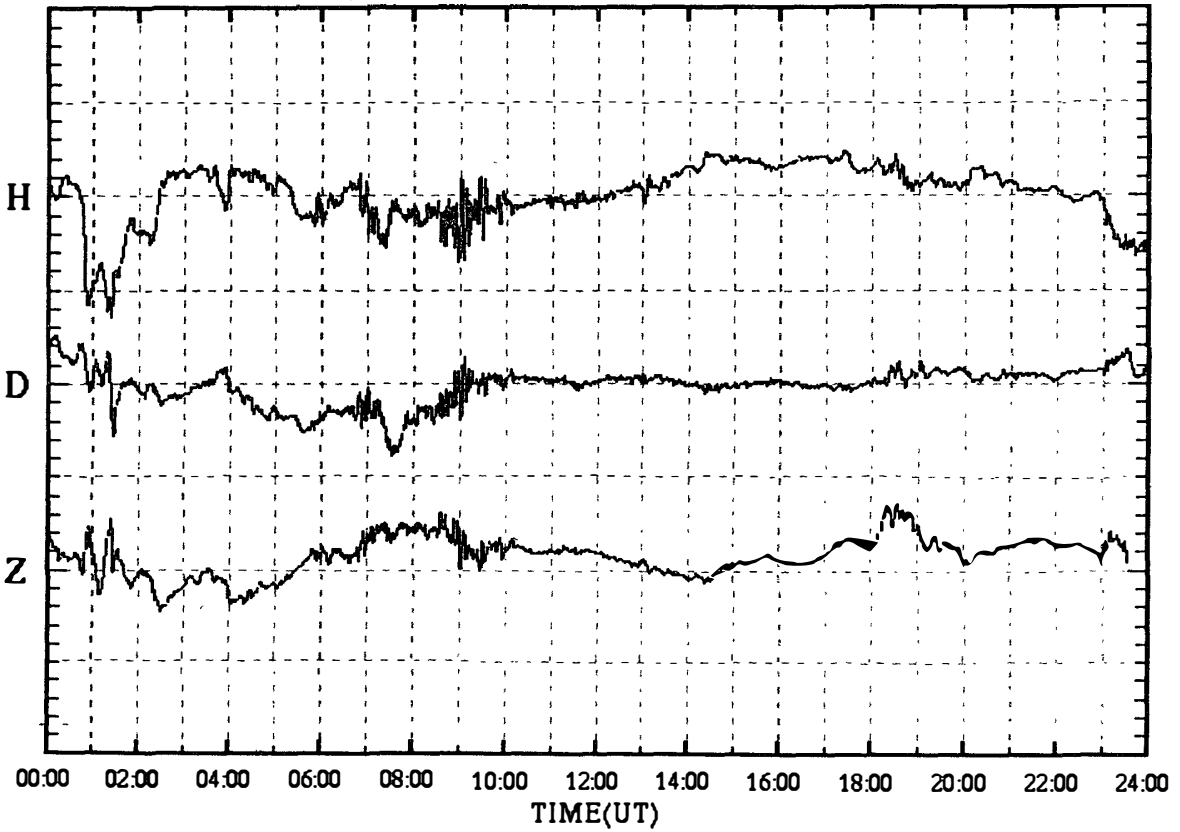

SYOWA magnetogram (100 nT/div)

28 Nov.2000 (DAY:333)

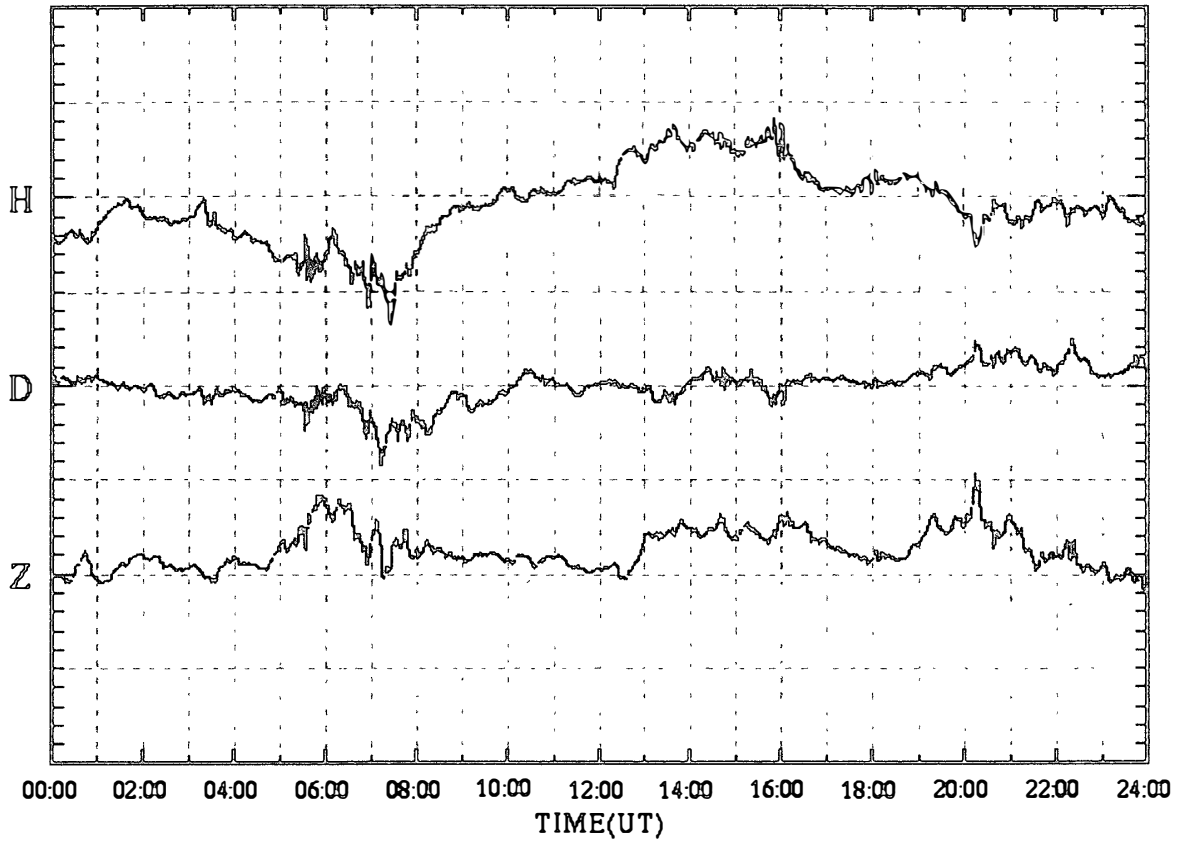

SYOWA magnetogram (100 nT/div)

29 Nov.2000 (DAY:334)

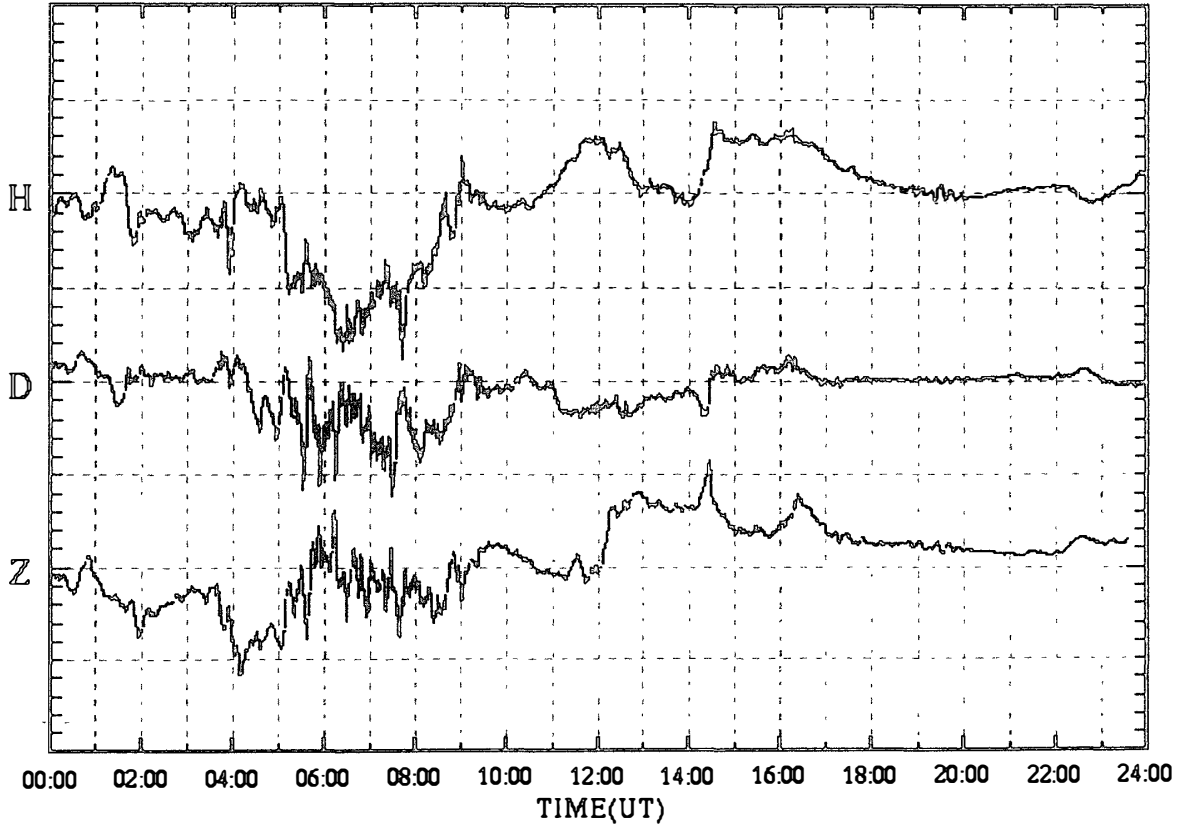

SYOWA magnetogram (100 nT/div)

30 Nov.2000 (DAY:335)

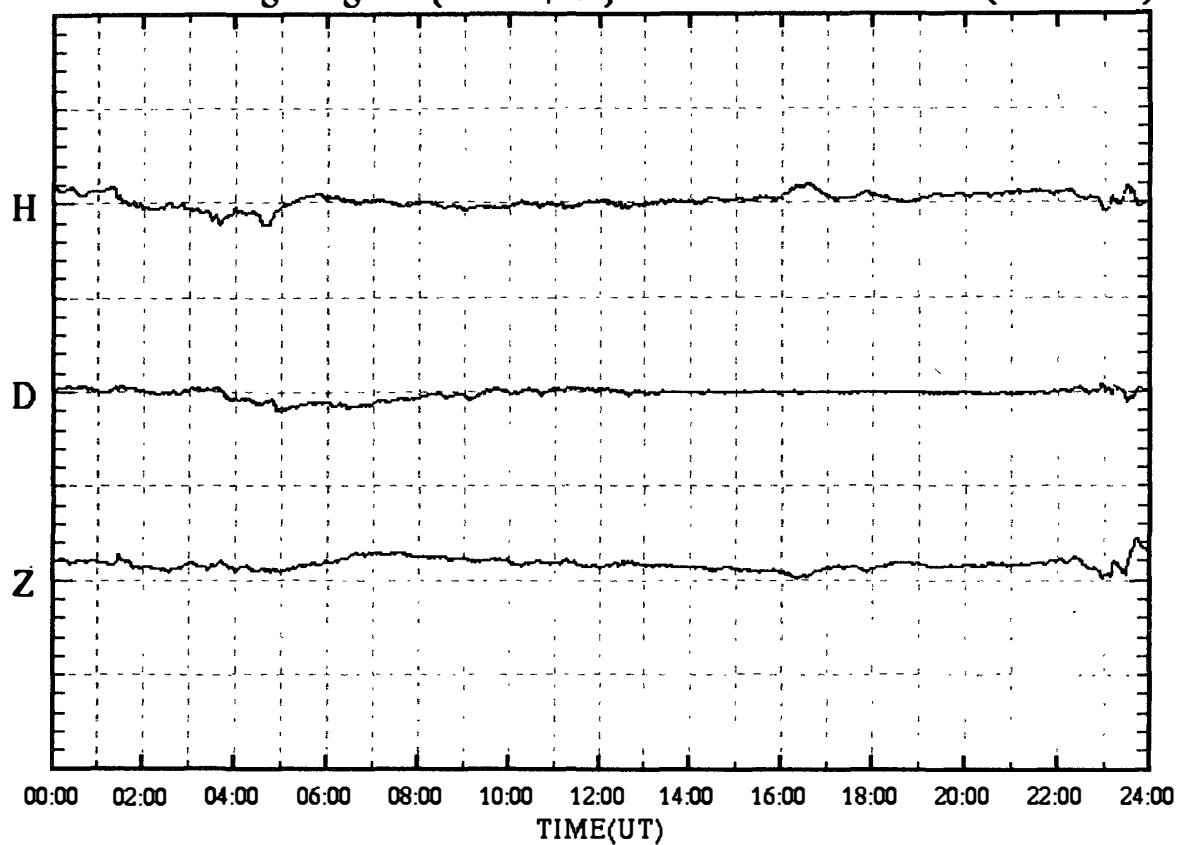

SYOWA magnetogram (100 nT/div)

01 Dec.2000 (DAY:336)

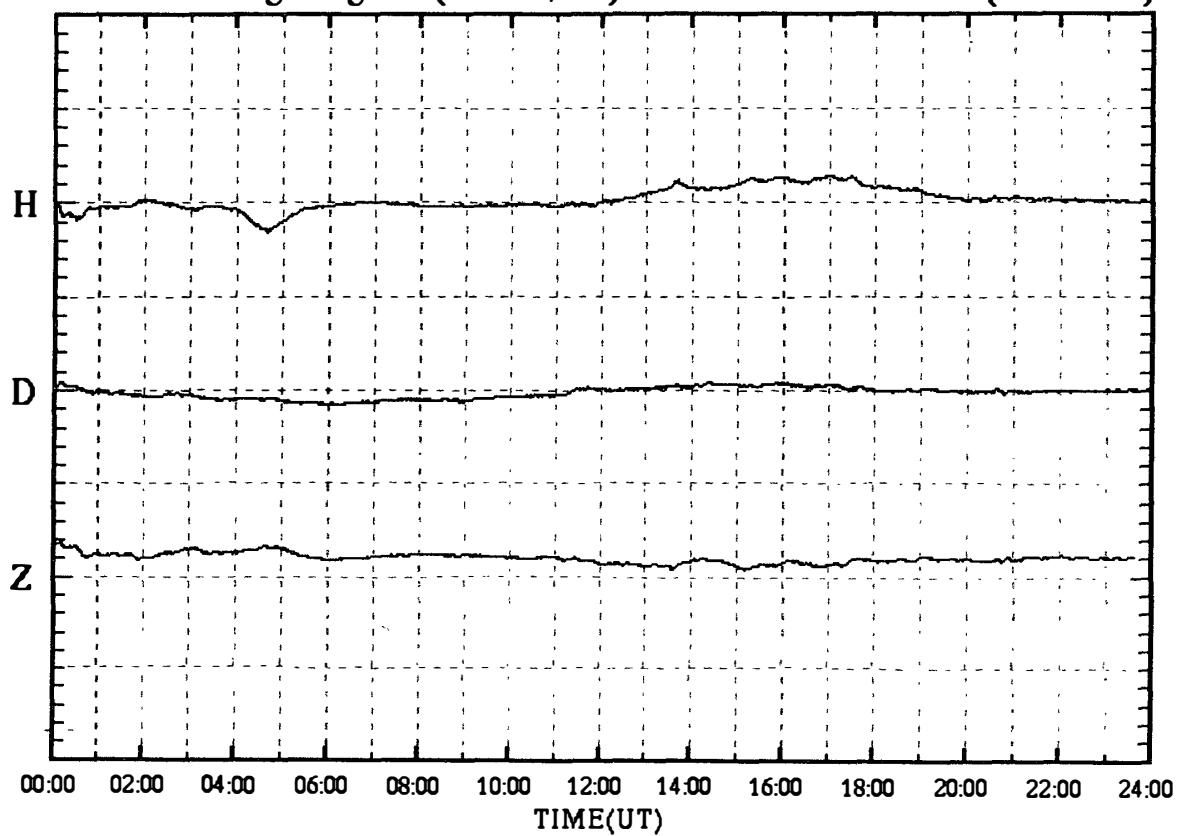

SYOWA magnetogram (100 nT/div)

02 Dec.2000 (DAY:337)

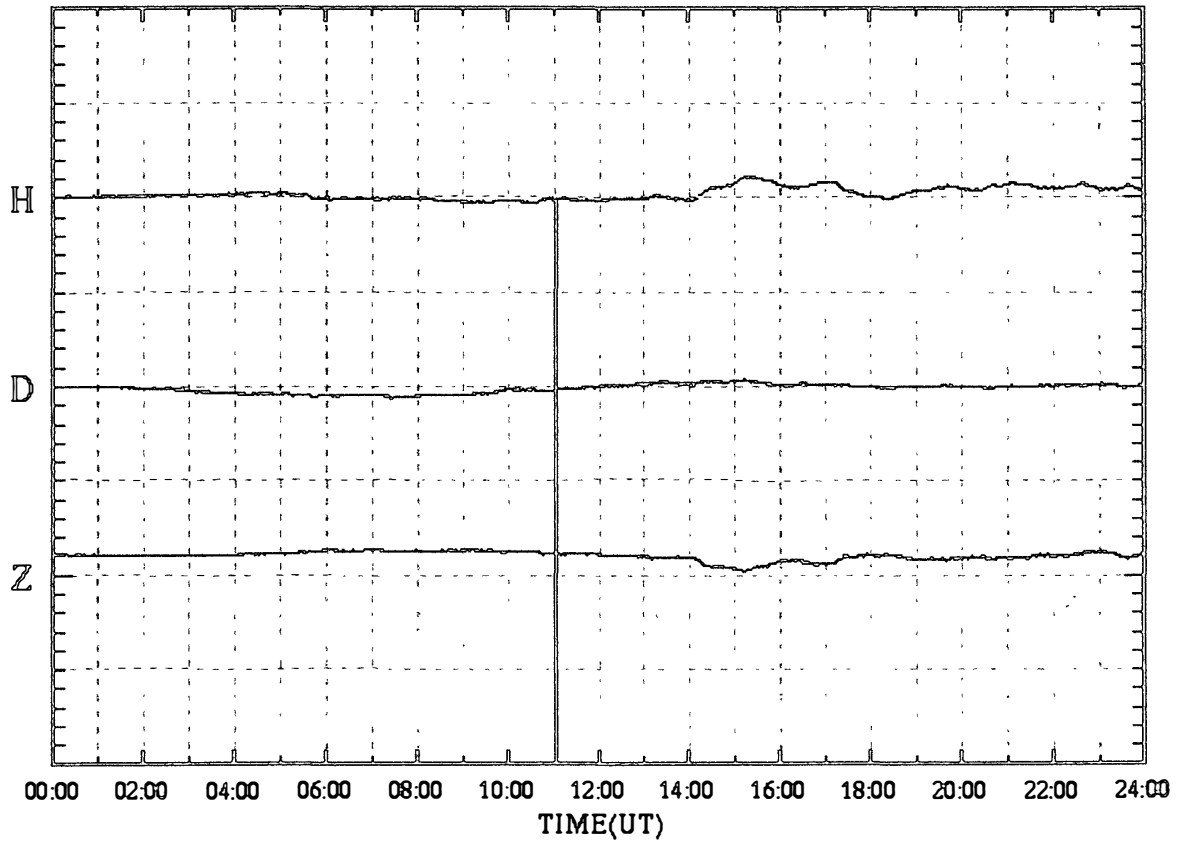

SYOWA magnetogram (100 nT/div)

03 Dec.2000 (DAY:338)

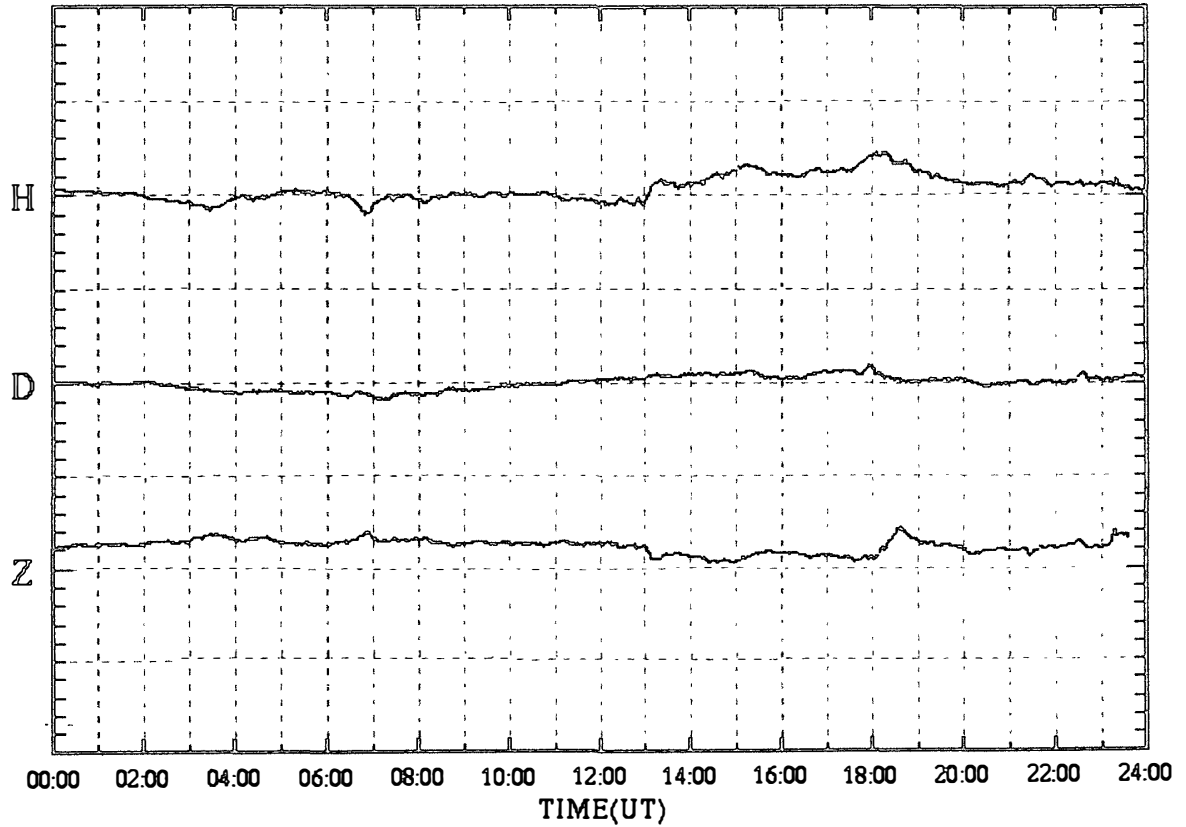

SYOWA magnetogram (100 nT/div)

04 Dec.2000 (DAY:339)

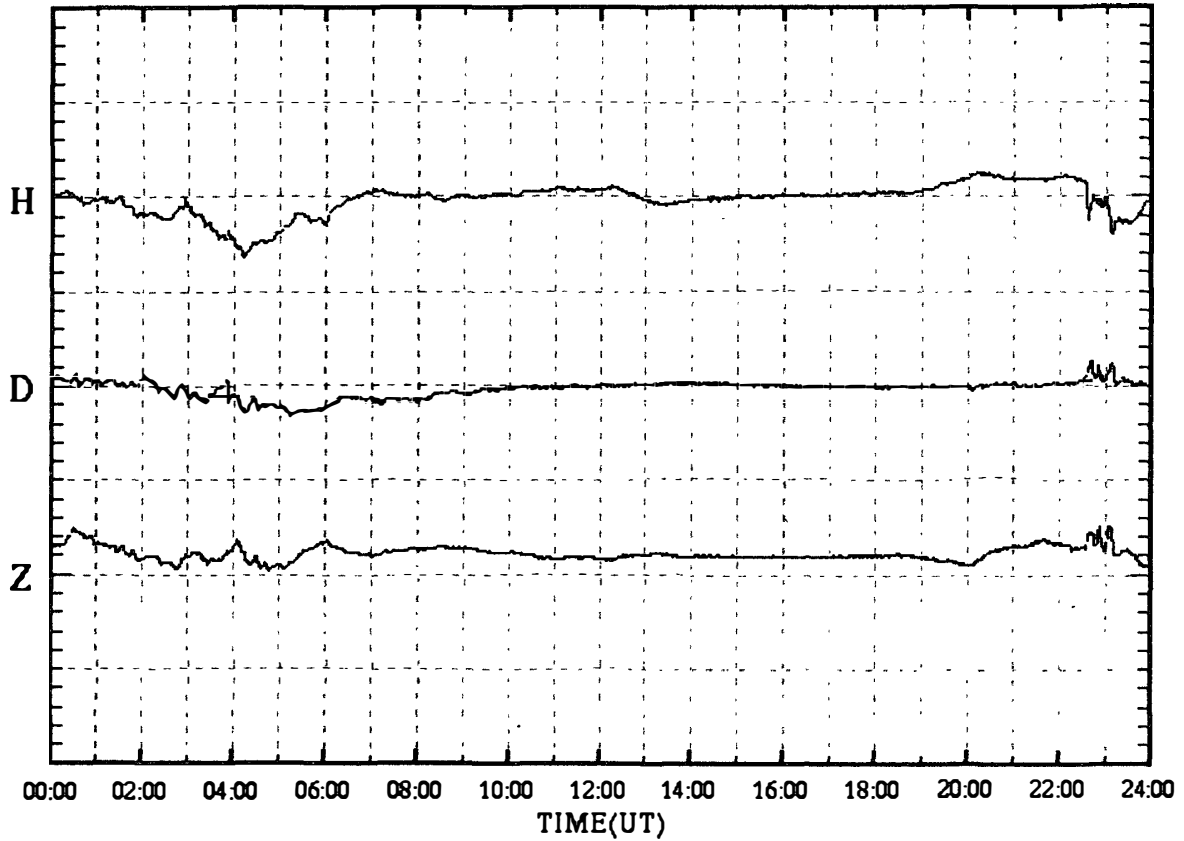

SYOWA magnetogram (100 nT/div)

05 Dec.2000 (DAY:340)

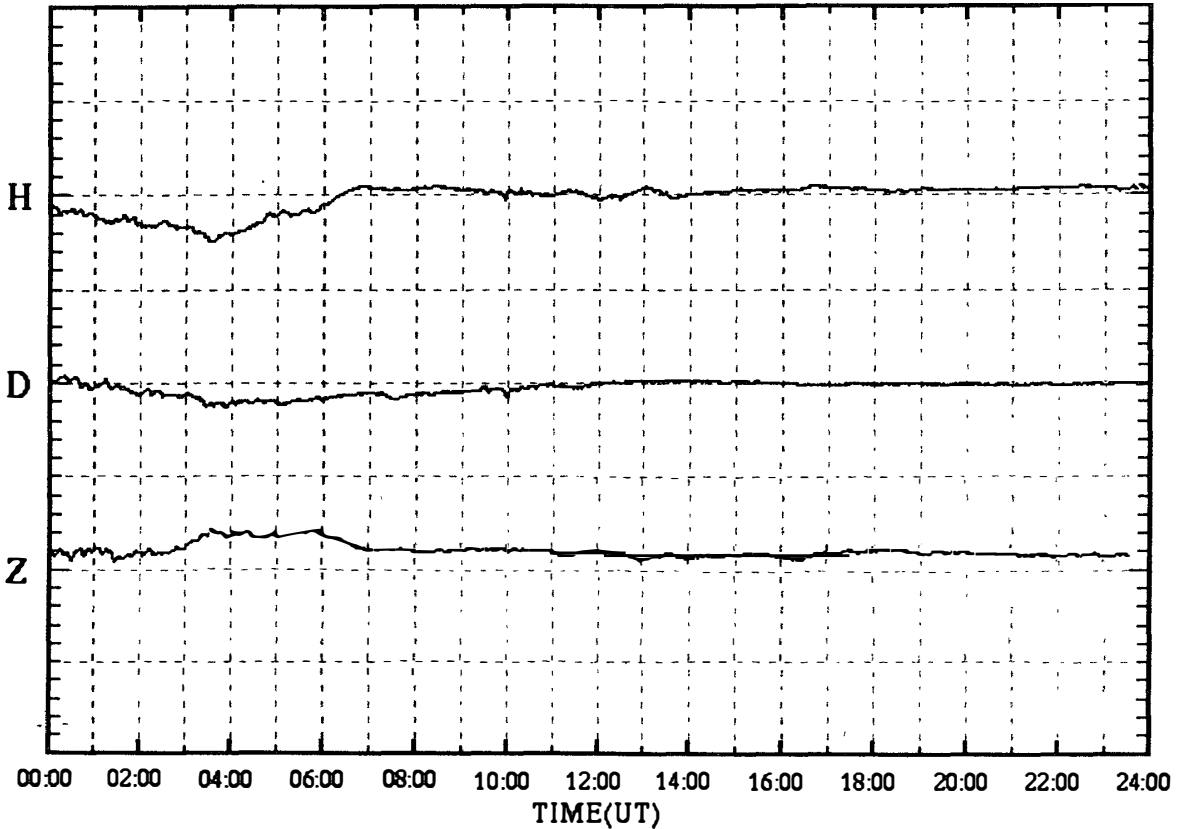

SYOWA magnetogram (100 nT/div)

06 Dec.2000 (DAY:341)

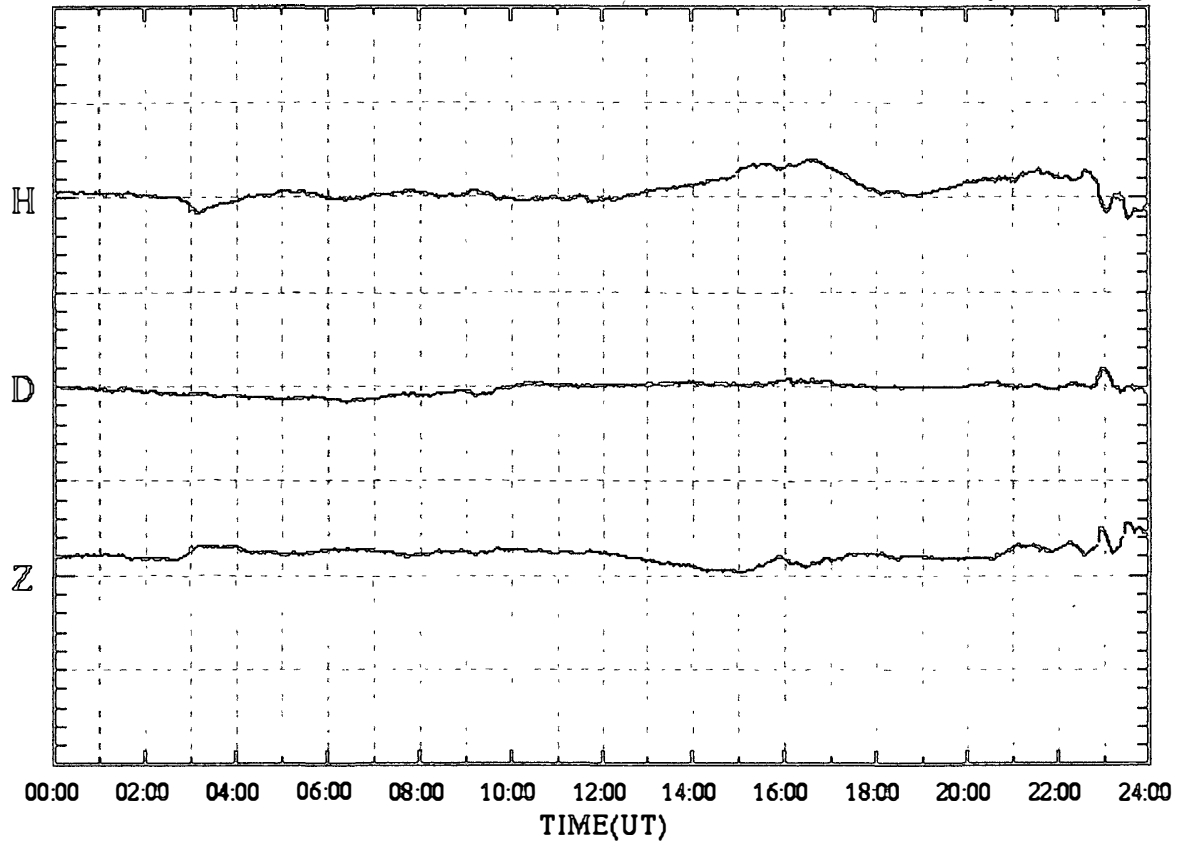

SYOWA magnetogram (100 nT/div)

07 Dec.2000 (DAY:342)

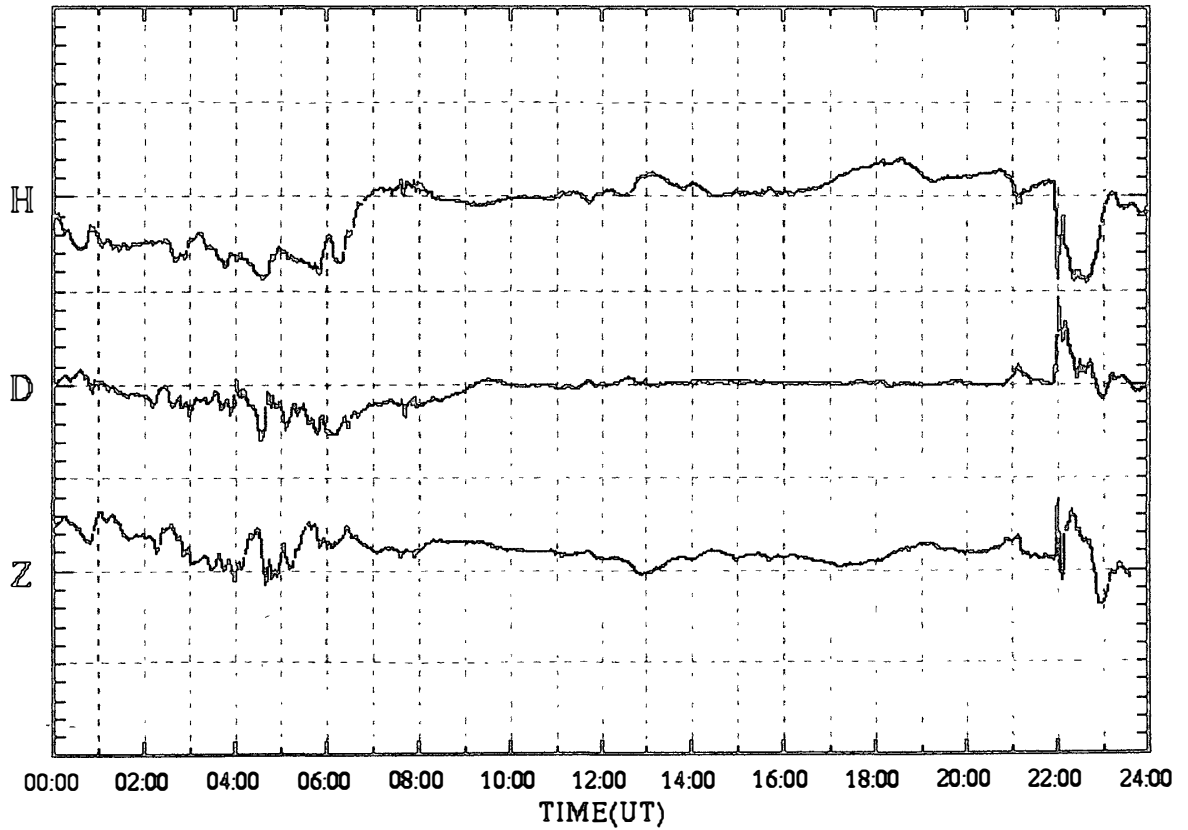

SYOWA magnetogram (100 nT/div)

08 Dec.2000 (DAY:343)

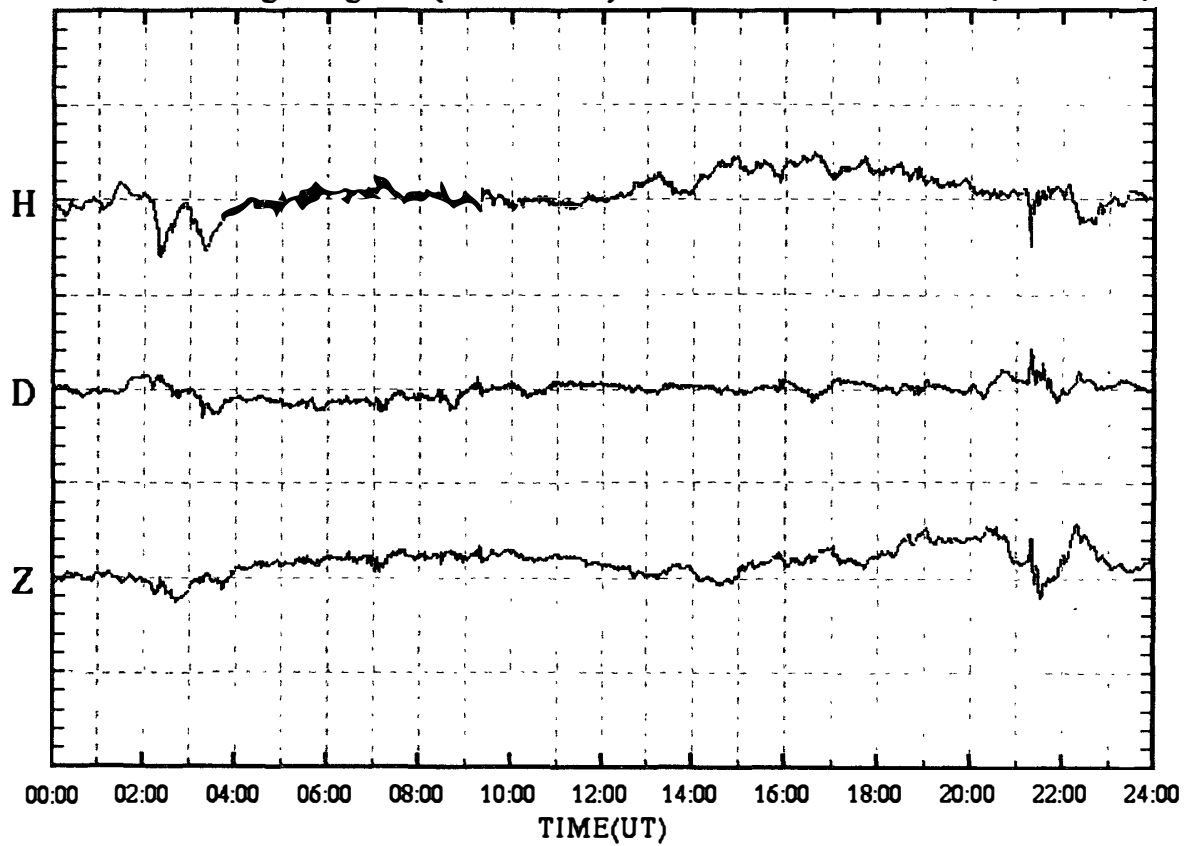

SYOWA magnetogram (100 nT/div)

09 Dec.2000 (DAY:344)

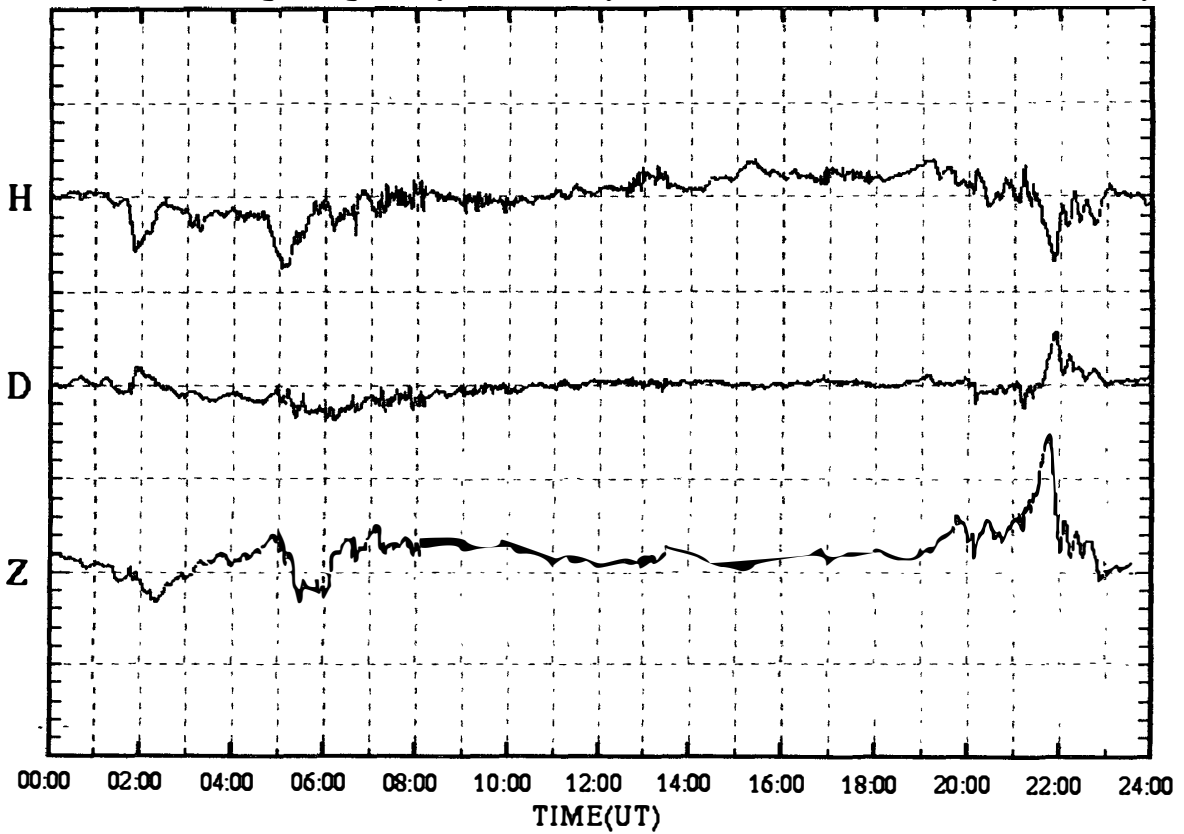

SYOWA magnetogram (100 nT/div)

10 Dec.2000 (DAY:345)

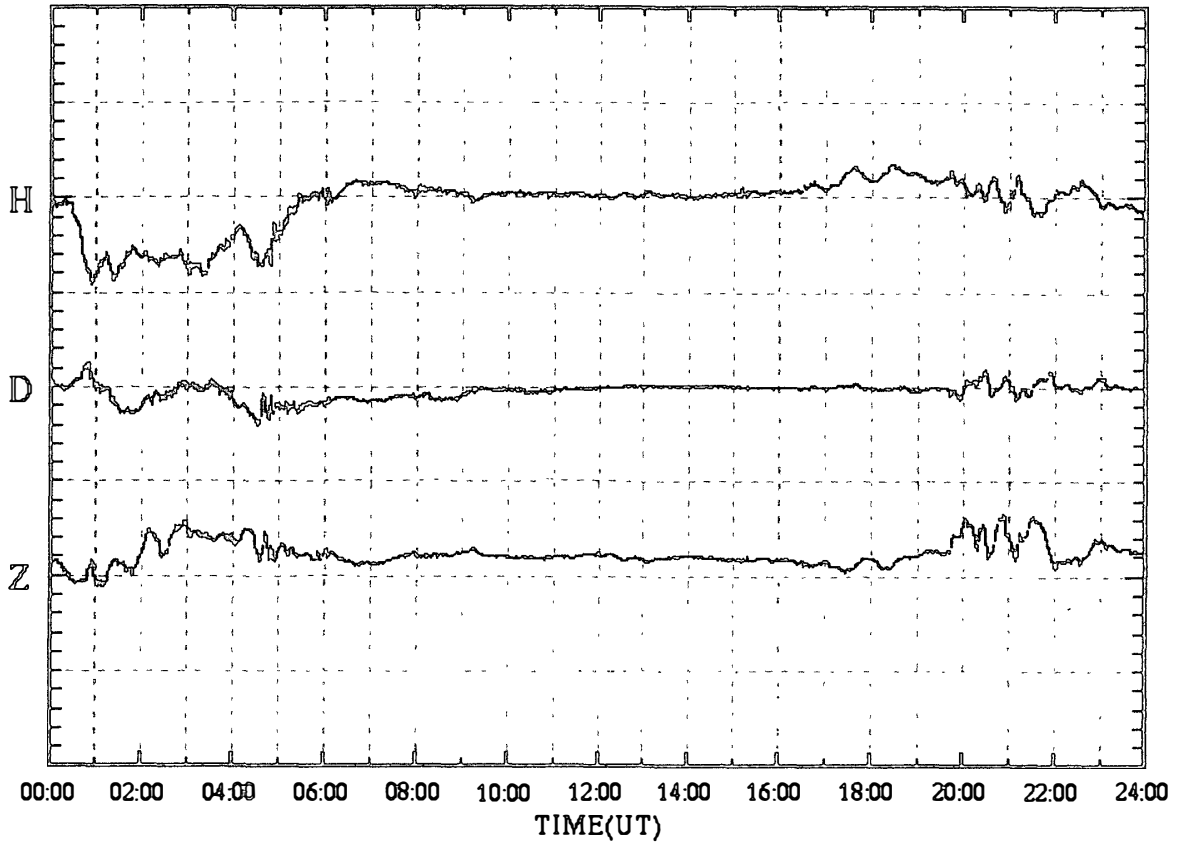

SYOWA magnetogram (100 nT/div)

11 Dec.2000 (DAY:346)

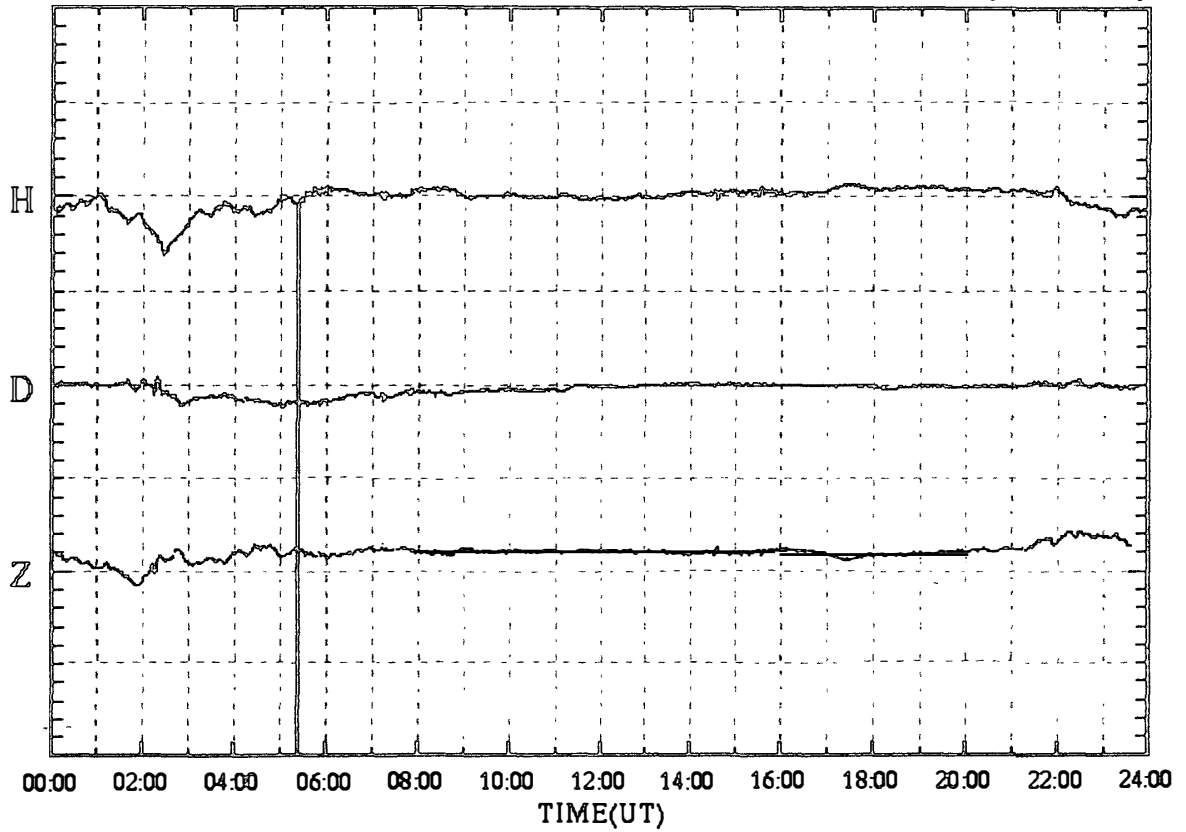

SYOWA magnetogram (100 nT/div)

12 Dec.2000 (DAY:347)

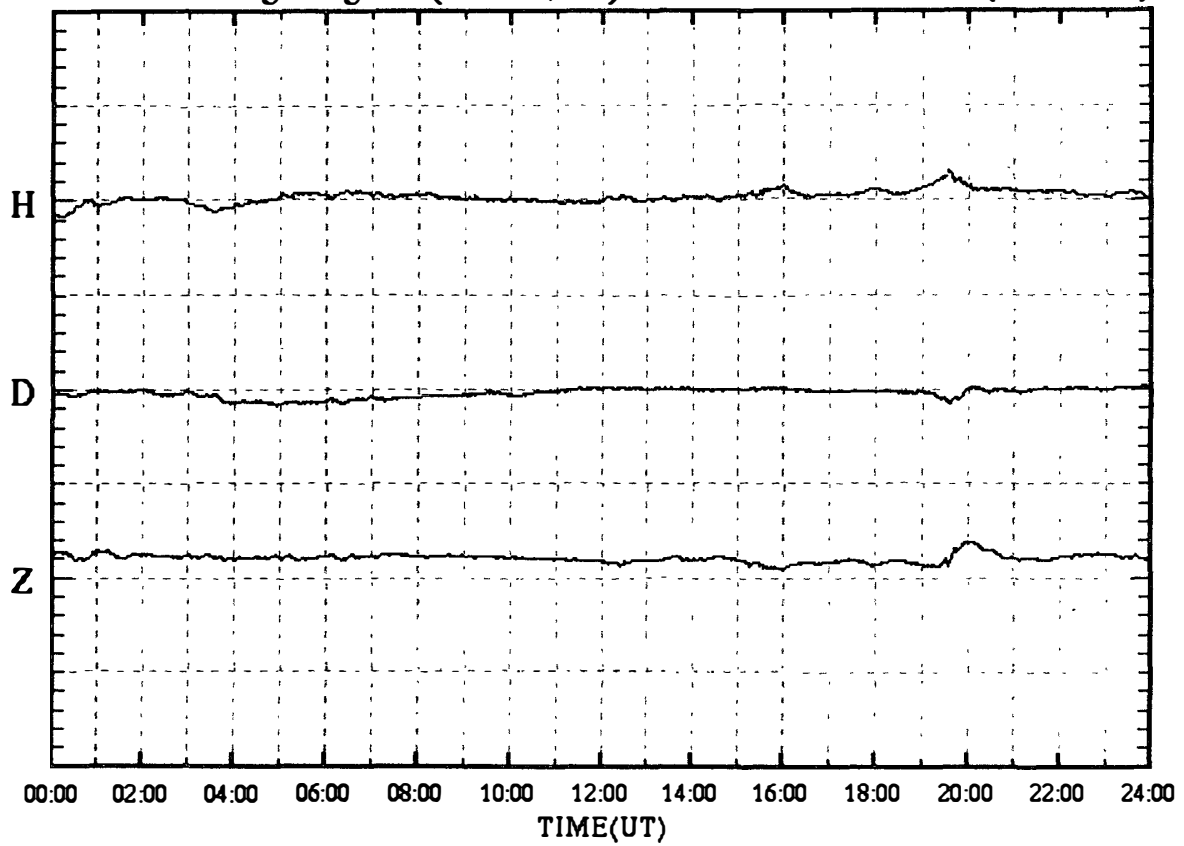

SYOWA magnetogram (100 nT/div)

13 Dec.2000 (DAY:348)

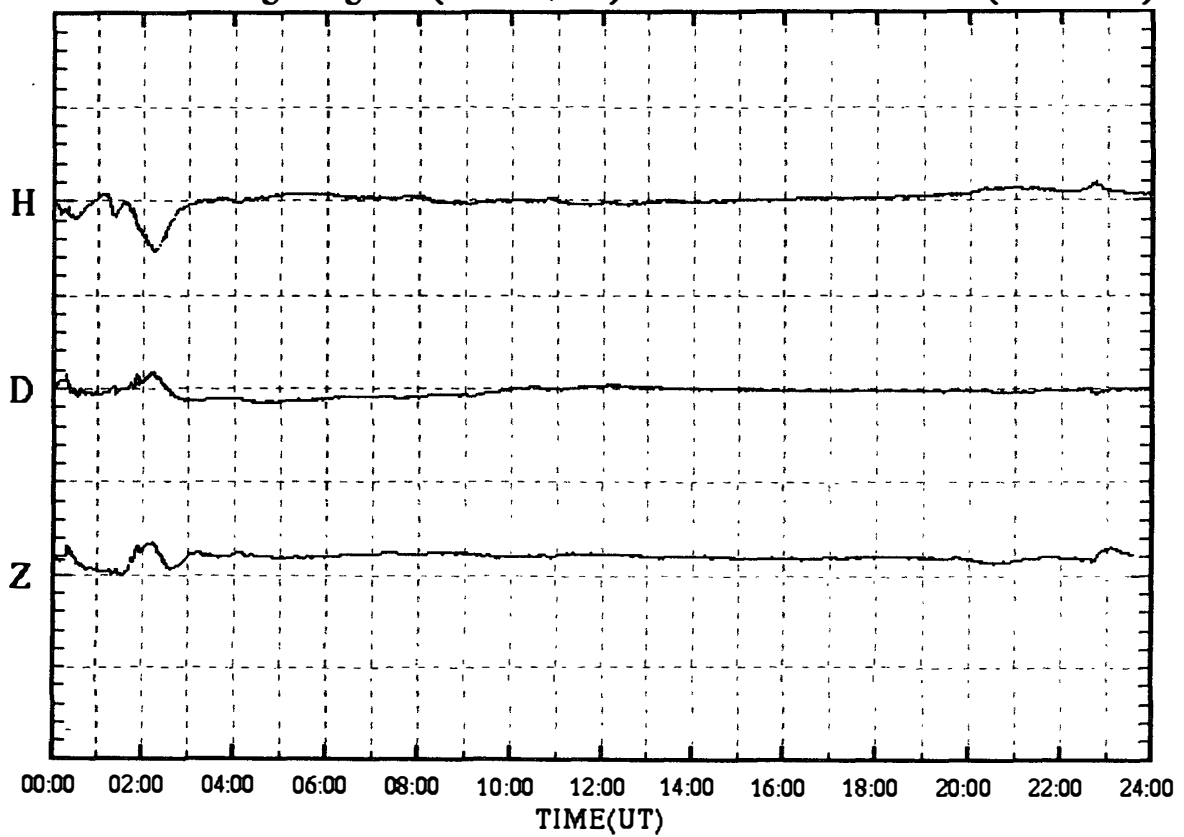

SYOWA magnetogram (100 nT/div)

14 Dec.2000 (DAY:349)

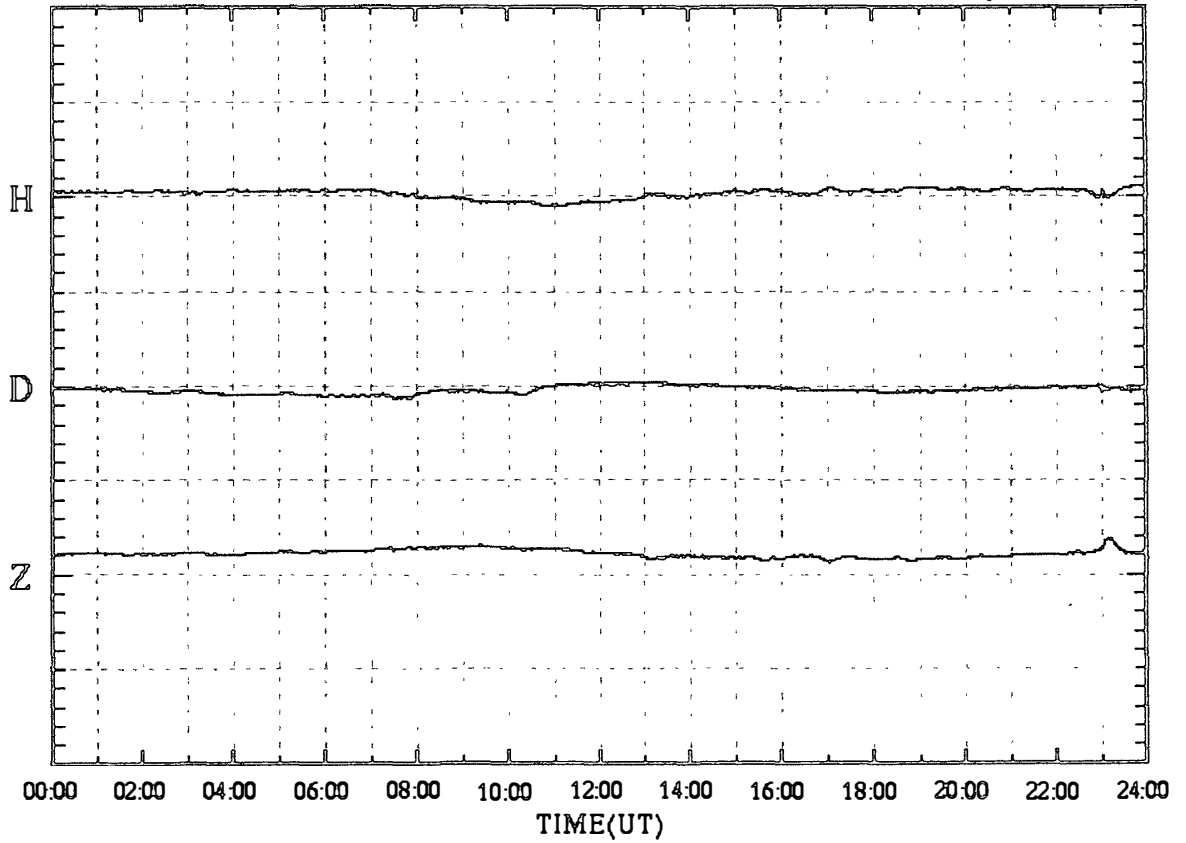

SYOWA magnetogram (100 nT/div)

15 Dec.2000 (DAY:350)

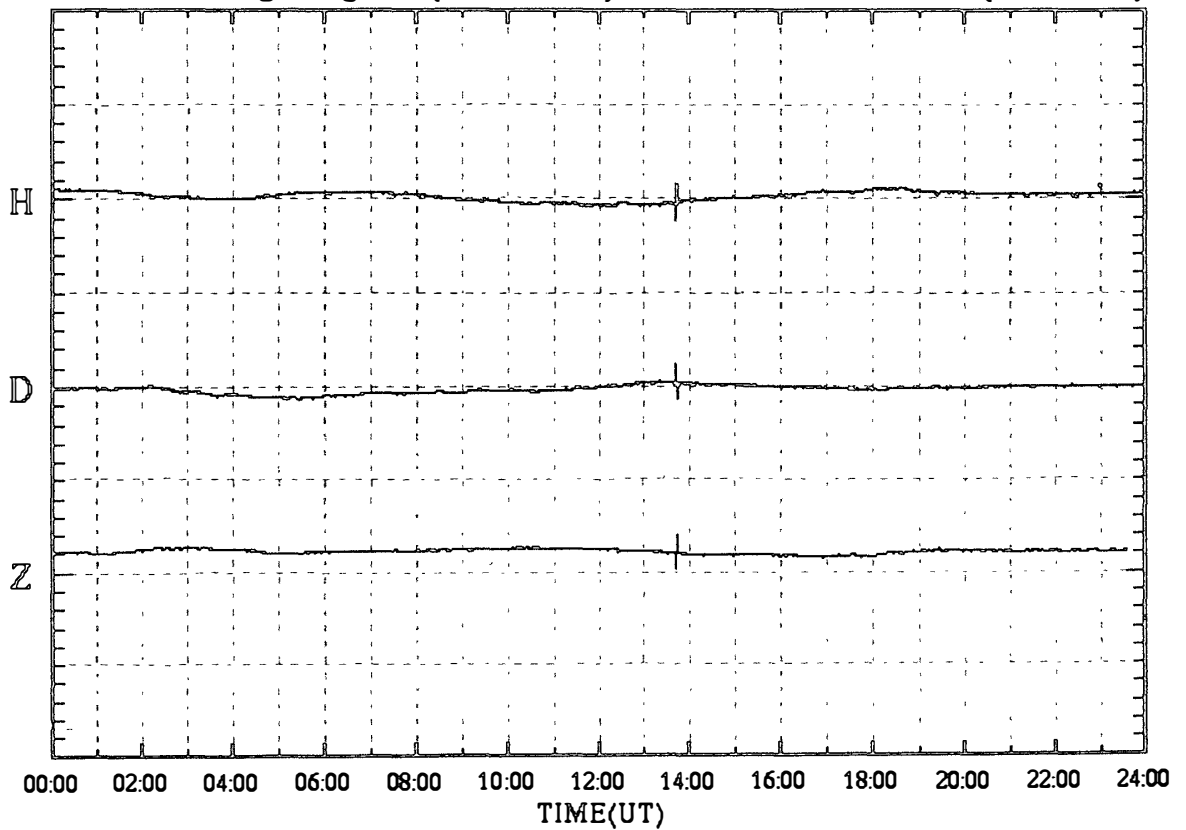

SYOWA magnetogram (100 nT/div)

16 Dec.2000 (DAY:351)

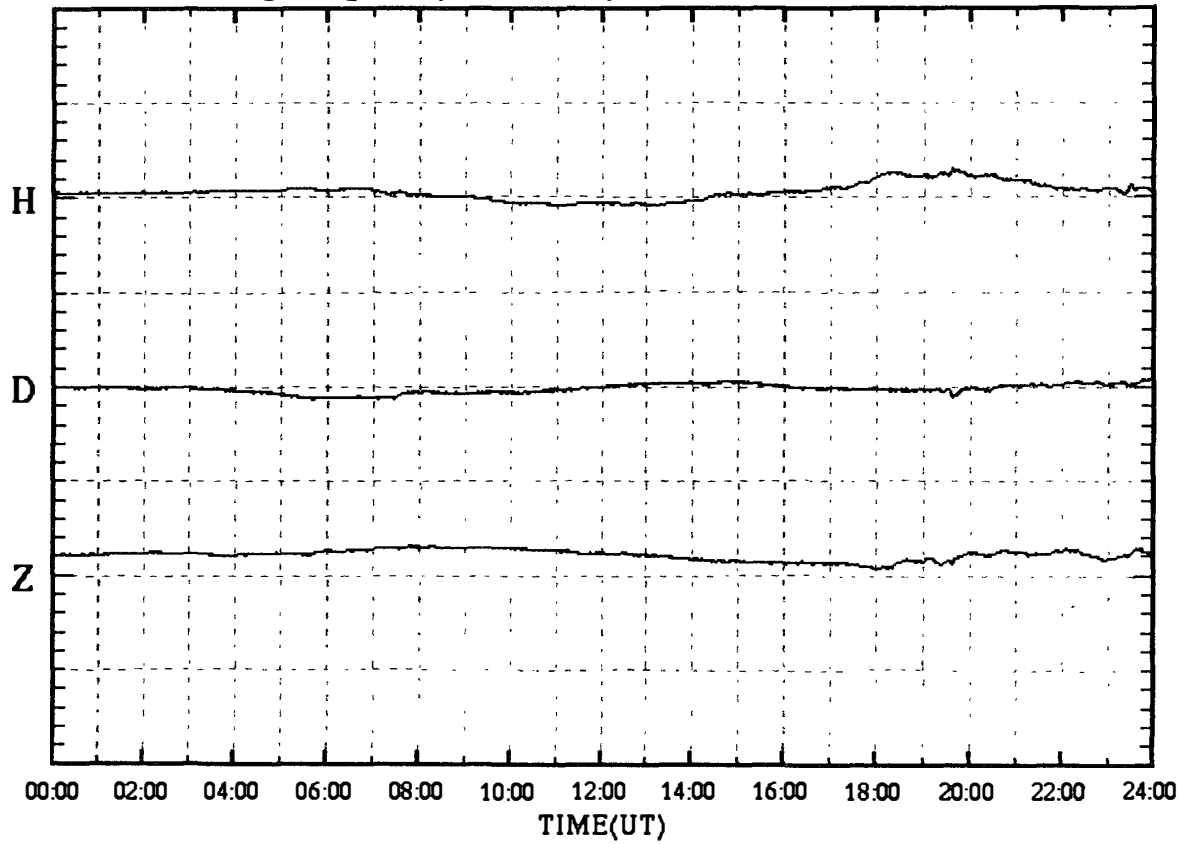

SYOWA magnetogram (100 nT/div)

17 Dec.2000 (DAY:352)

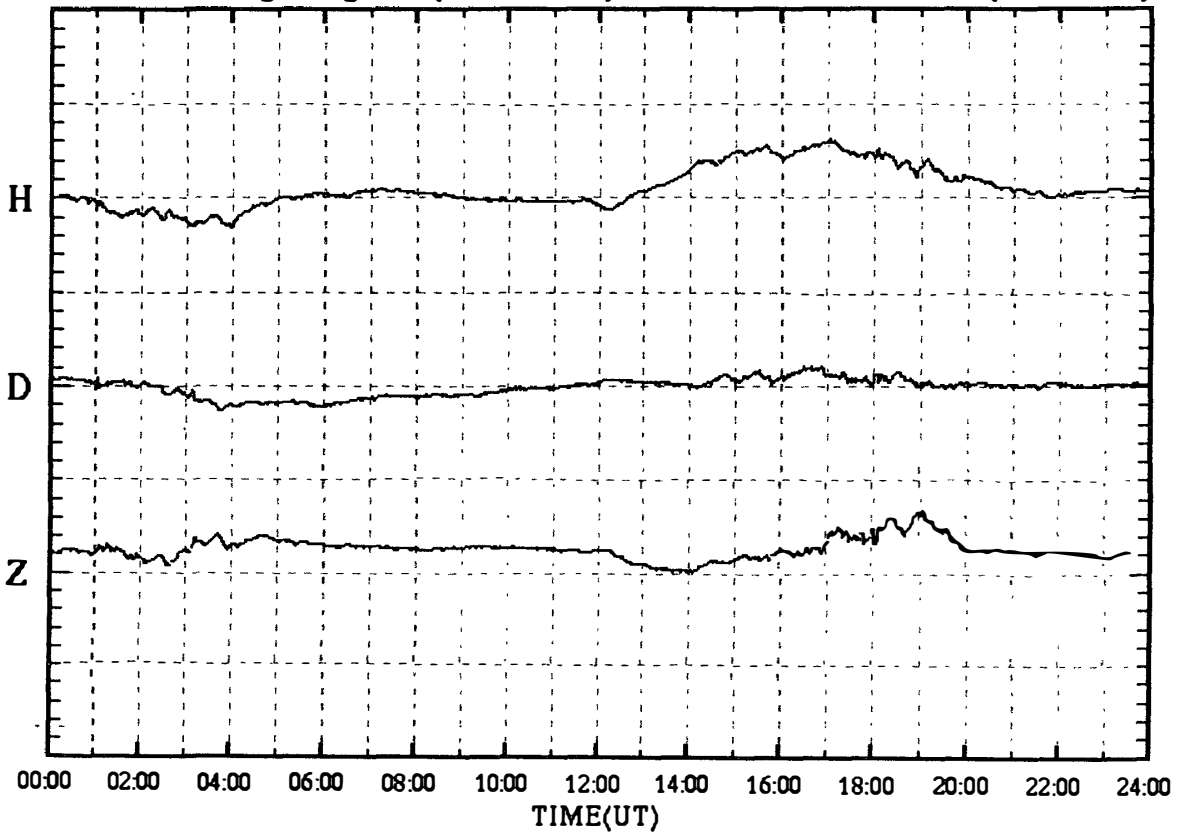

SYOWA magnetogram (100 nT/div)

18 Dec.2000 (DAY:353)

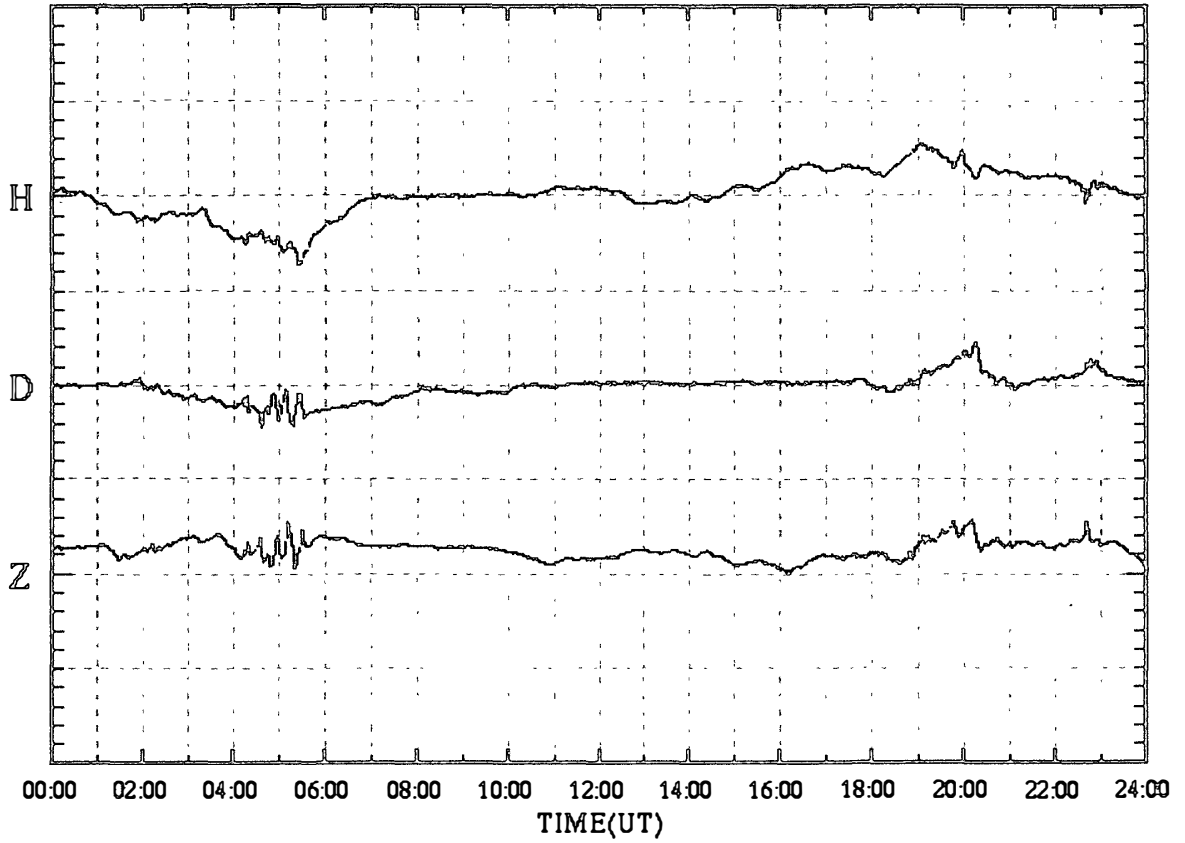

SYOWA magnetogram (100 nT/div)

19 Dec.2000 (DAY:354)

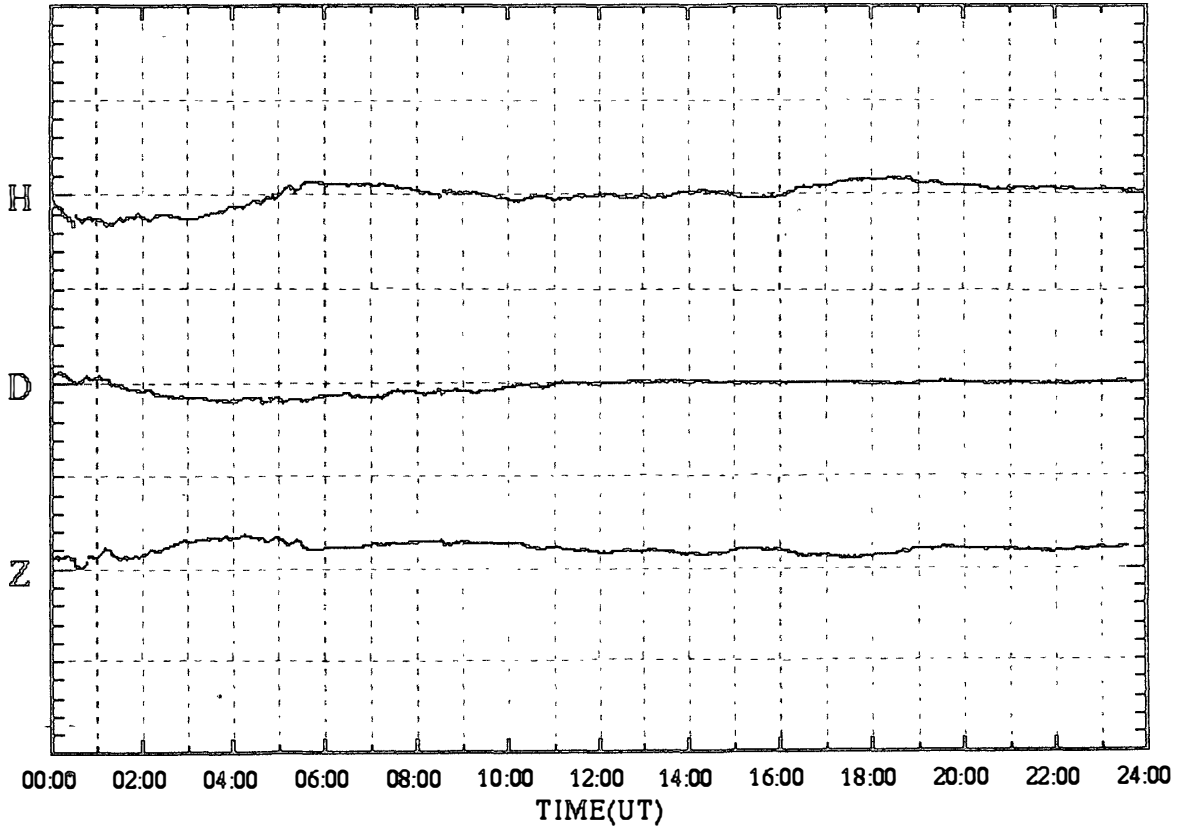

SYOWA magnetogram (100 nT/div)

20 Dec.2000 (DAY:355)

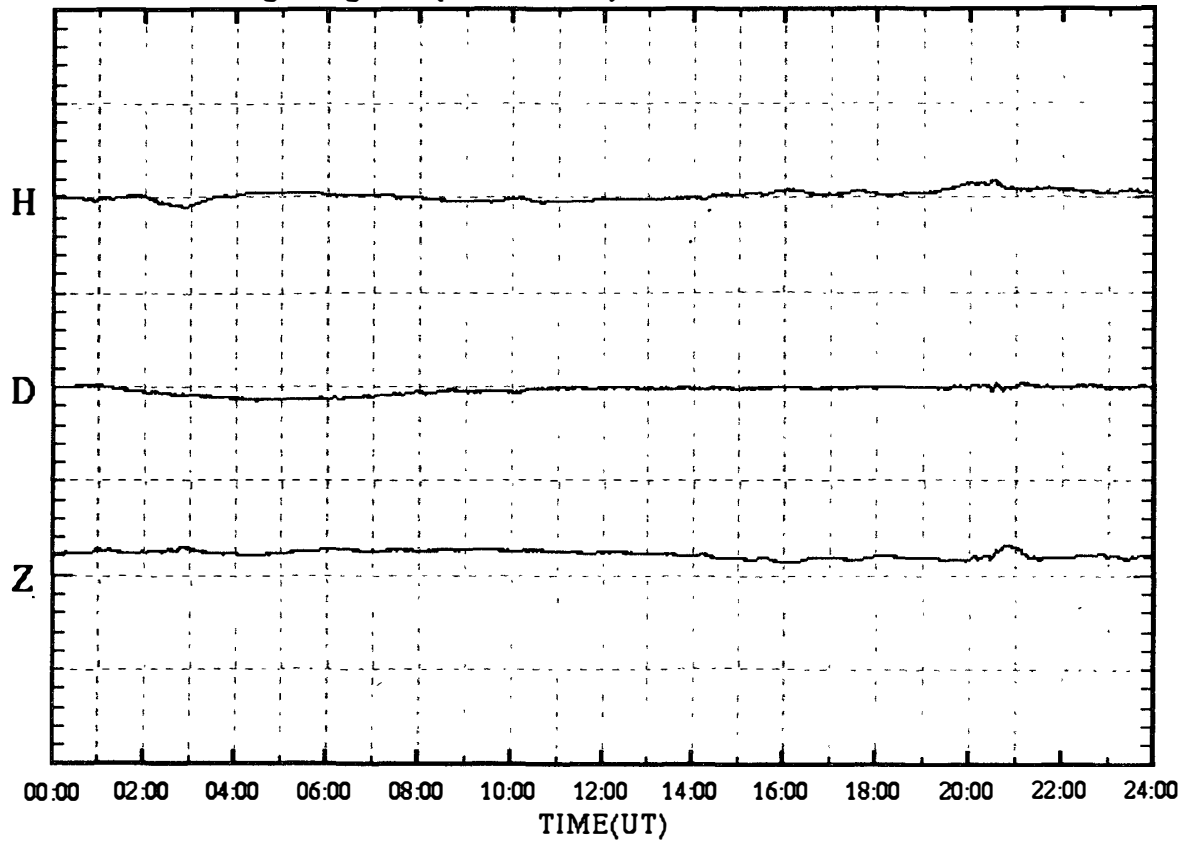

SYOWA magnetogram (100 nT/div)

21 Dec.2000 (DAY:356)

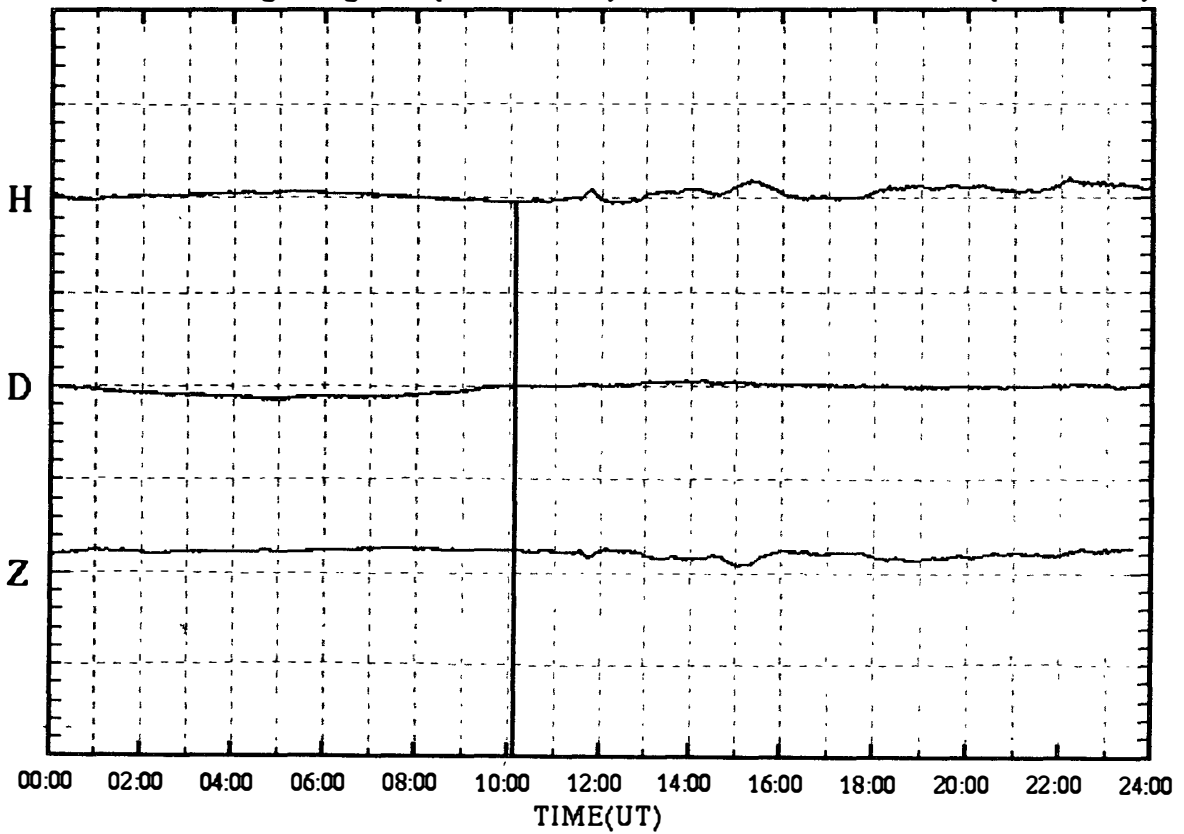

SYOWA magnetogram (100 nT/div)

22 Dec.2000 (DAY:357)

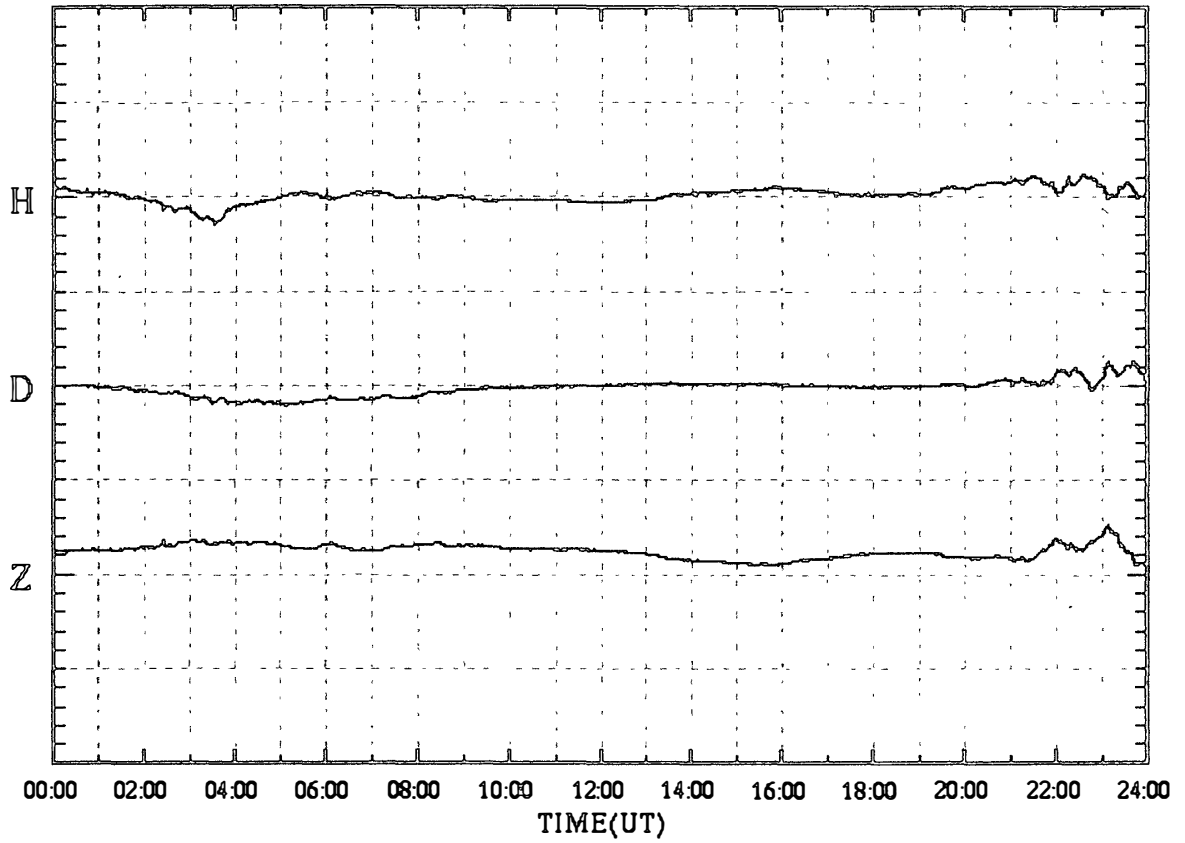

SYOWA magnetogram (100 nT/div)

23 Dec.2000 (DAY:358)

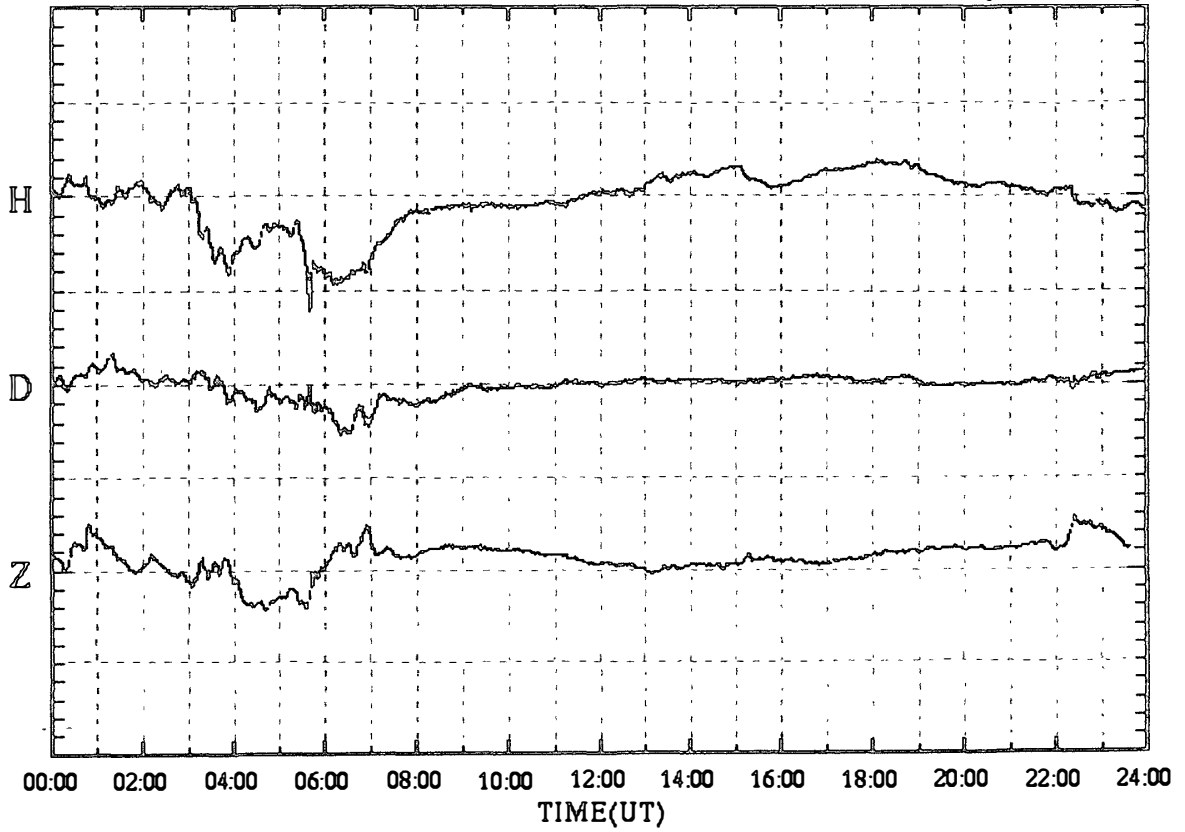

SYOWA magnetogram (100 nT/div)

24 Dec.2000 (DAY:359)

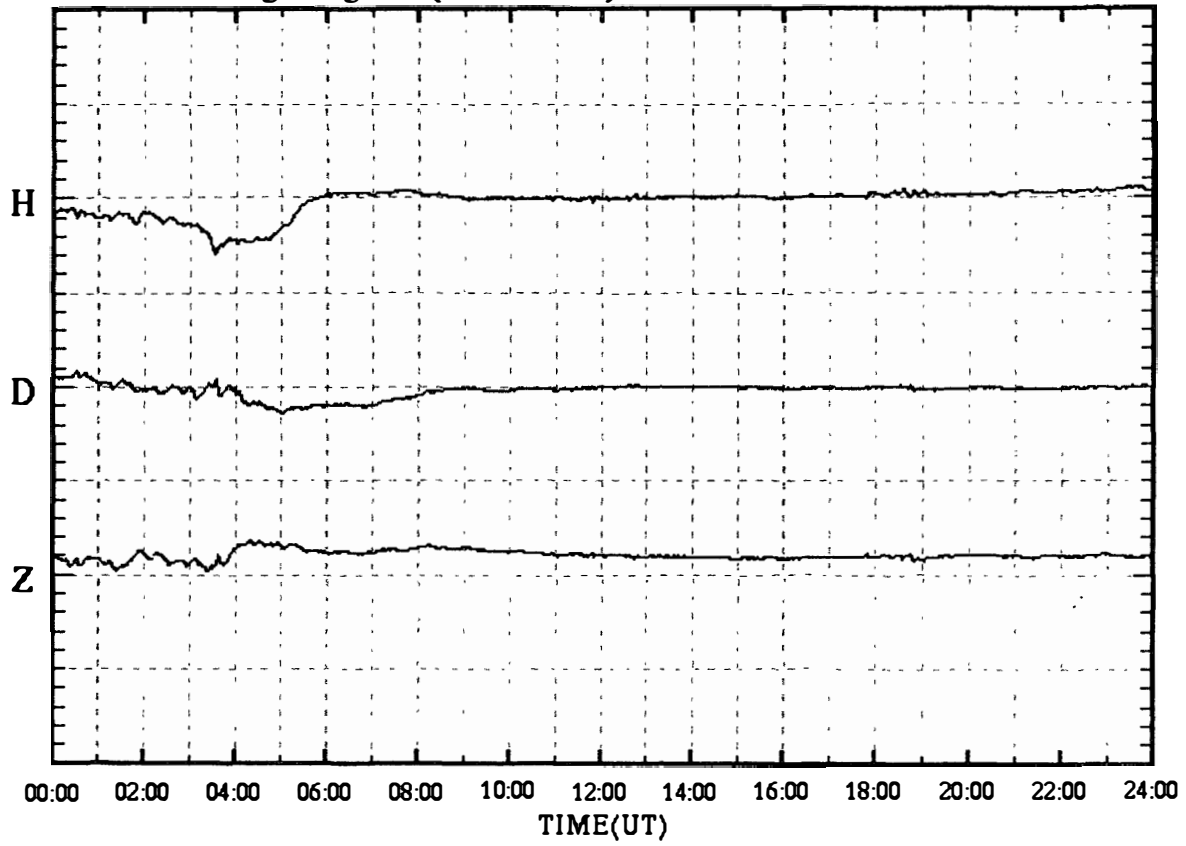

SYOWA magnetogram (100 nT/div)

25 Dec.2000 (DAY:360)

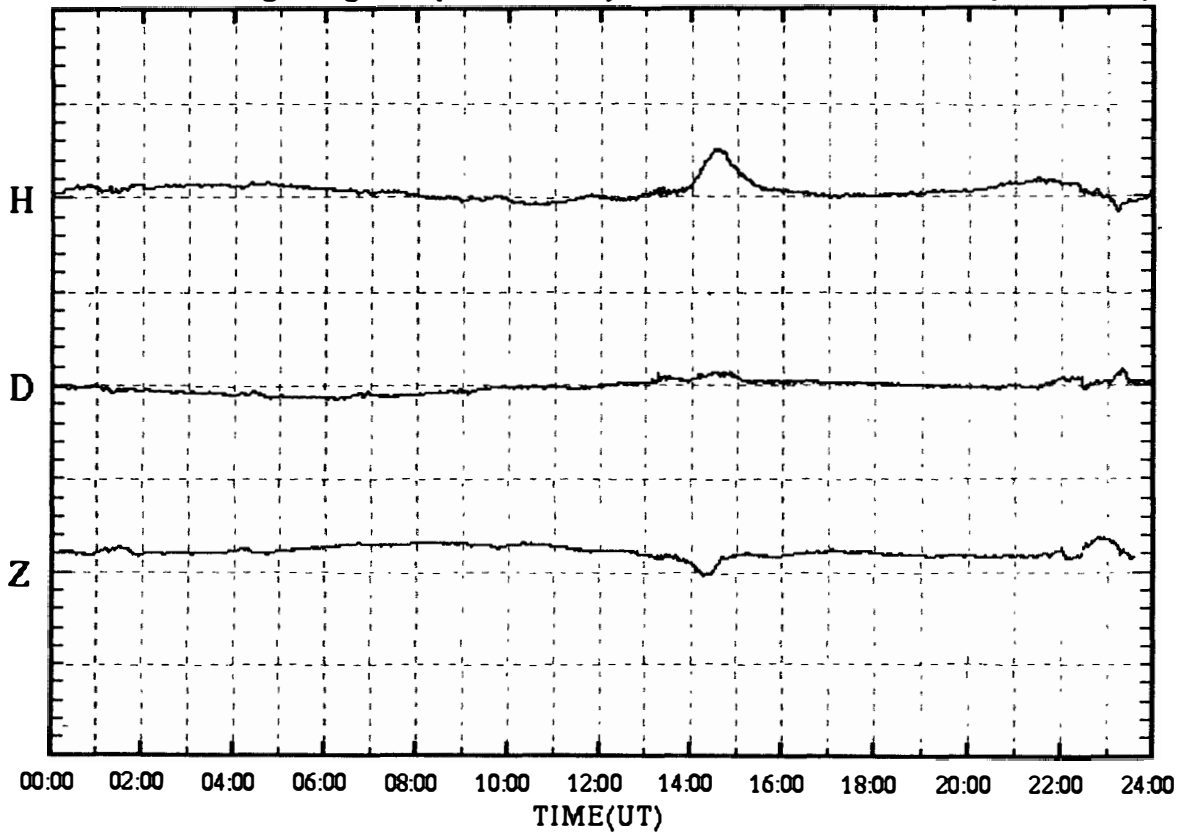

SYOWA magnetogram (100 nT/div)

26 Dec.2000 (DAY:361)

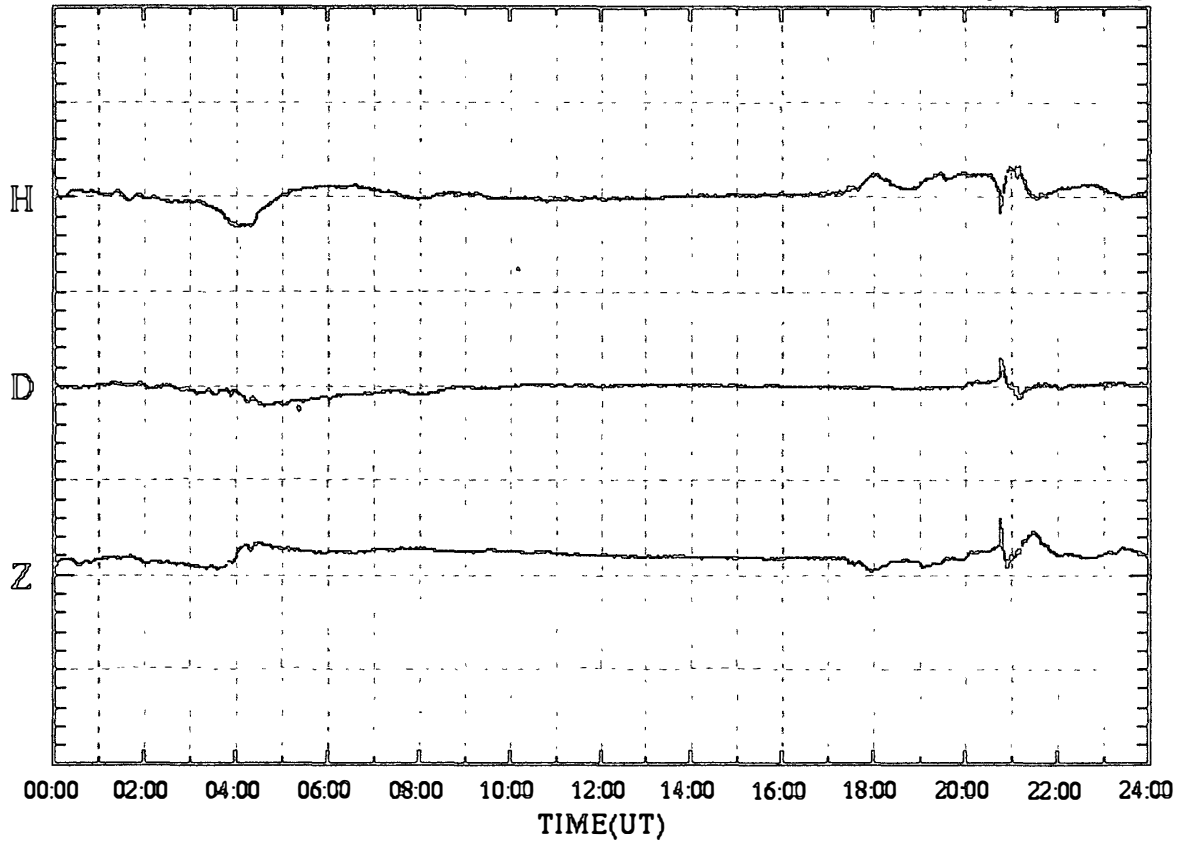

SYOWA magnetogram (100 nT/div)

27 Dec.2000 (DAY:362)

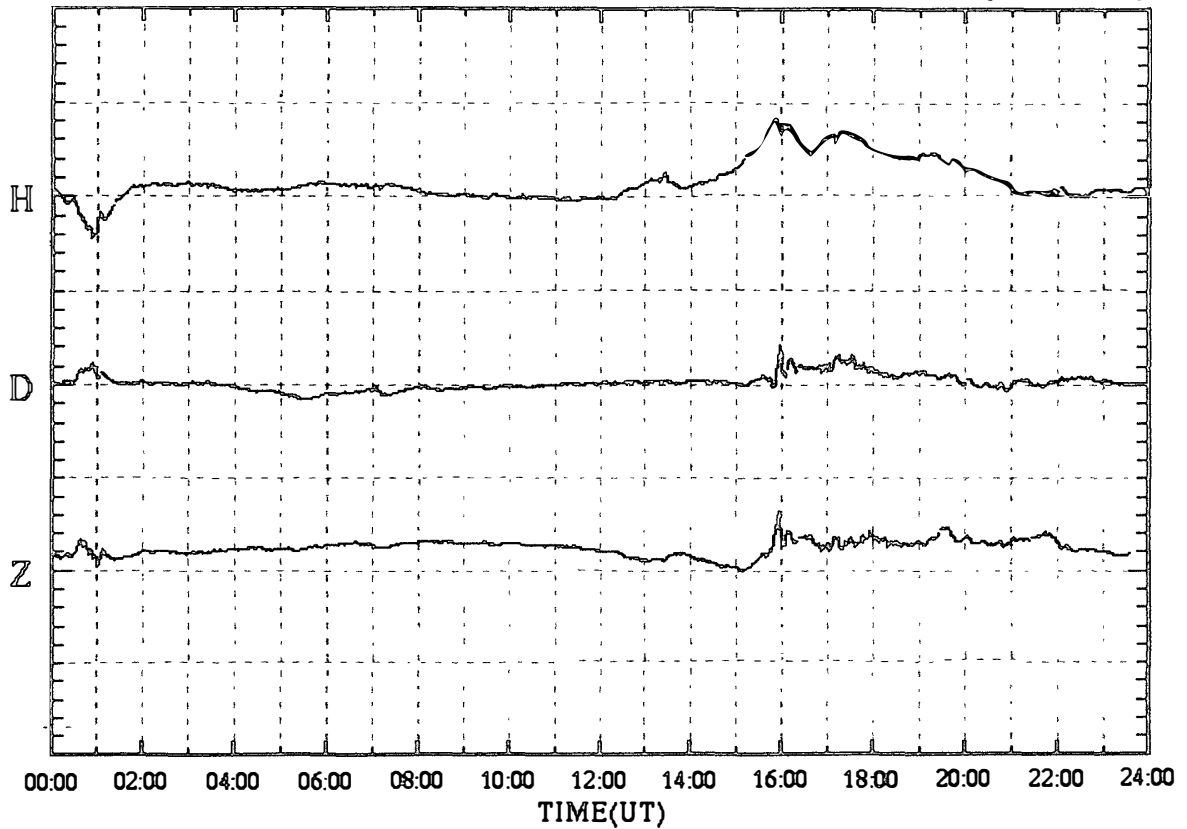

SYOWA magnetogram (100 nT/div)

28 Dec.2000 (DAY:363)

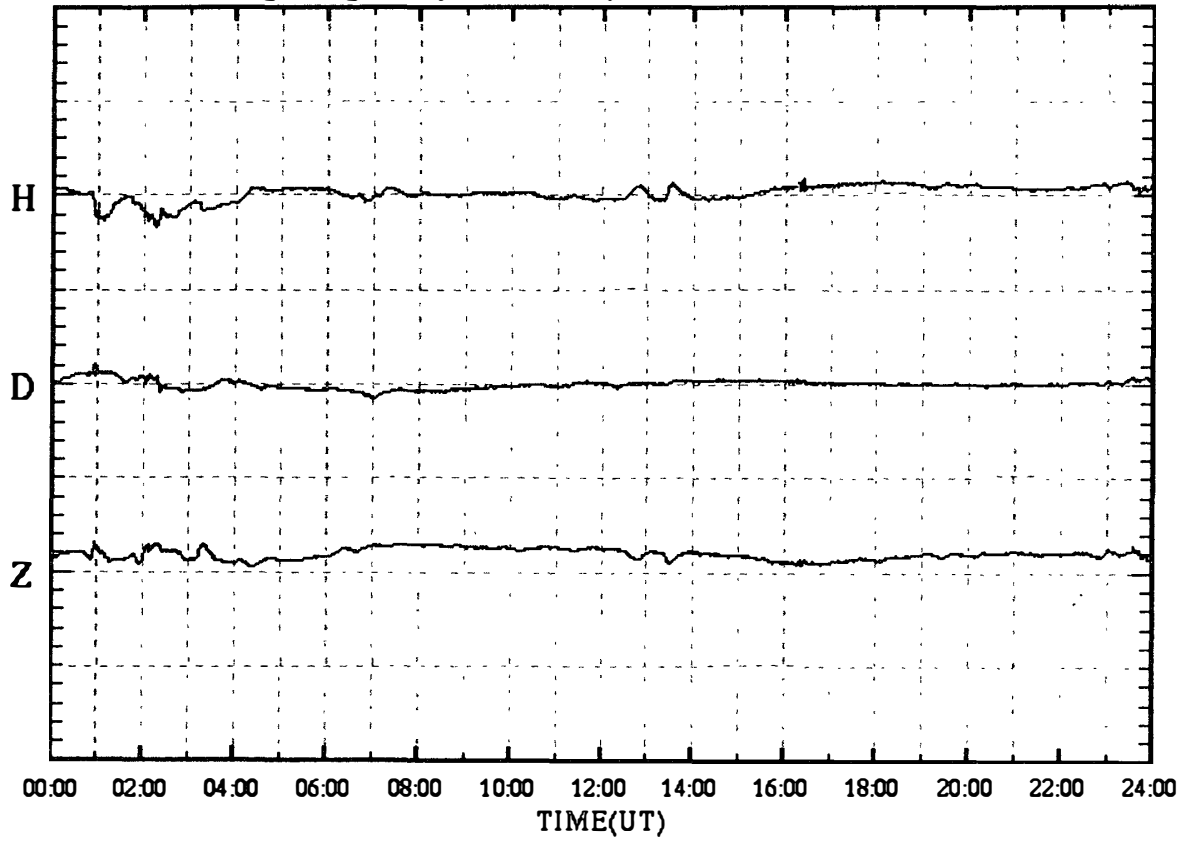

SYOWA magnetogram (100 nT/div)

29 Dec.2000 (DAY:364)

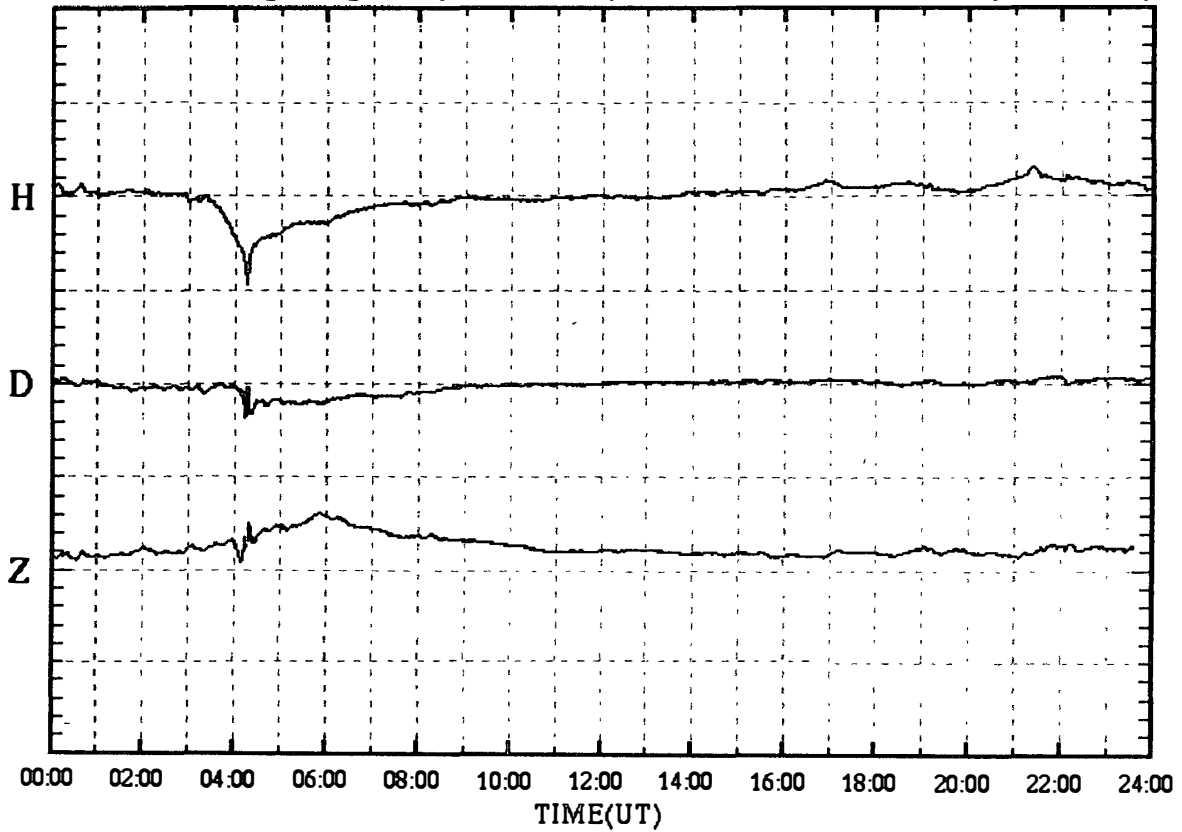

SYOWA magnetogram (100 nT/div)

30 Dec.2000 (DAY:365)

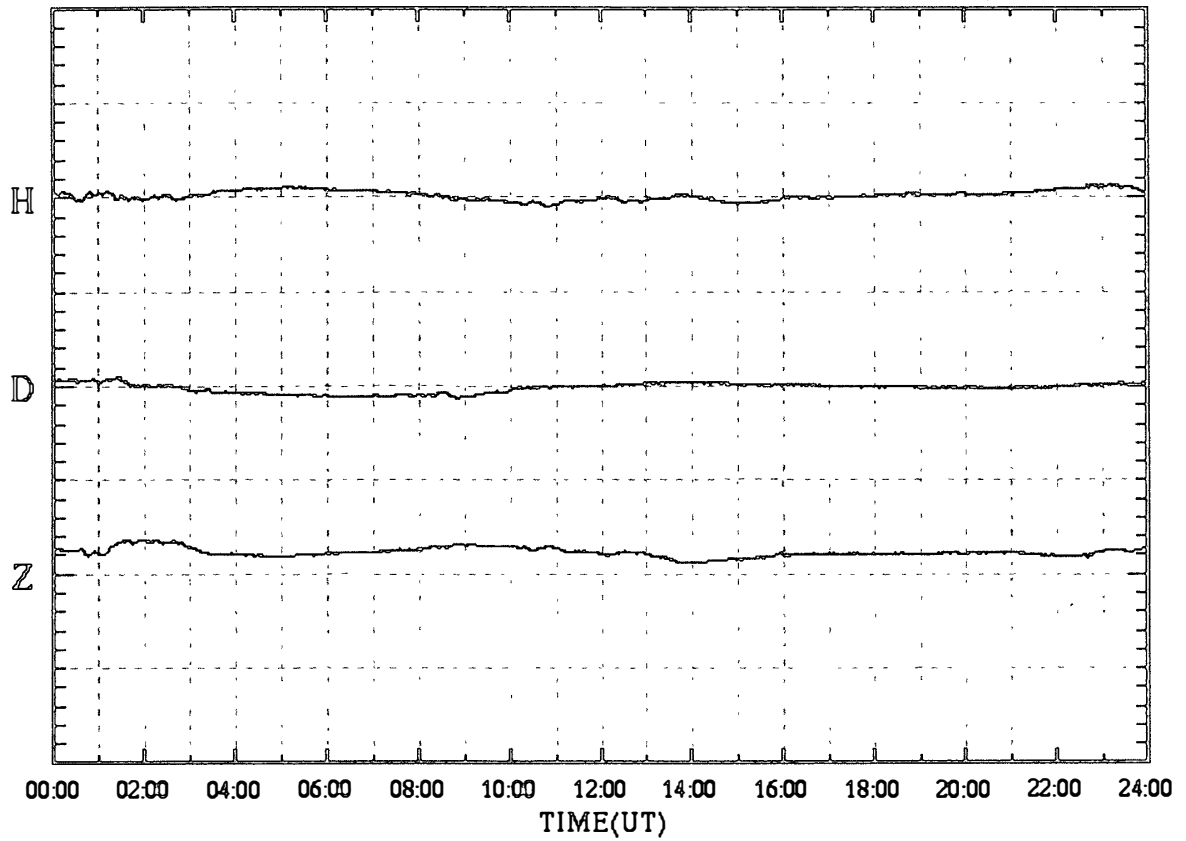

SYOWA magnetogram (100 nT/div)

31 Dec.2000 (DAY:366)

