

# UPPER ATMOSPHERE PHYSICS DATA OBTAINED AT SYOWA STATION IN 1999

Kimio MAEGAWA<sup>1</sup>, Nobuo YAMAOKA<sup>2</sup>, Takuya D. KAWAHARA<sup>3</sup>,  
Masaki TSUTSUMI<sup>4</sup>, Hiroshi NAKAMOTO<sup>5</sup>, Shu TAKESHITA<sup>4</sup>,  
Masayuki KIKUCHI<sup>4</sup>, Akira KADOKURA<sup>4</sup> and Makoto TAGUCHI<sup>4</sup>

<sup>1</sup>*Fukui National College of Technology, Sabae-shi, Fukui 916-8507*

<sup>2</sup>*Osaka University, Suita-shi, Osaka 565-0871*

<sup>3</sup>*Shinshu University, Nagano-shi, Nagano 380-8553*

<sup>4</sup>*National Institute of Polar Research, Itabashi-ku, Tokyo 173-8515*

<sup>5</sup>*Communication Research Laboratory, Koganei-shi, Tokyo 184-8795*

## 1. Introduction

This data book summarizes upper atmosphere physics data acquired by the 40th Japanese Antarctic Research Expedition (JARE-40) with the "Upper Atmosphere Physics Monitoring (UAPM) System" at Syowa Station in 1999. Observation items are as follows:

- 1) Geomagnetism :
  - H-, D- and Z-components of magnetic variations
  - Total force of the geomagnetic field
  - H-, D- and Z-components of magnetic pulsations
- 2) ELF-VLF wave :
  - Intensities at 0.35, 0.75, 1.2, 2, 4, 8, 30, 60 and 95 kHz
  - Wide-band (0-10 kHz) signal of ELF-VLF emissions
- 3) Ionosphere :
  - Cosmic noise absorption at 30 MHz observed with a broad-beam riometer
- 4) Aurora :
  - All-sky imagers :
    - CCD type : Panchromatic images recorded in a digital format
    - Video type : Panchromatic video signal recorded by analog tapes
  - Scanning photometers :
    - Meridian-scanning record at the following five wavelengths  
427.8 nm ( $N_2^+ 1NG$ ), 486.1 nm ( $H\beta$ ), 487.4 nm (BG of  $H\beta$ ),  
557.7 nm (OI), and 630.0 nm (OI)

An outline of the observation system is given in Section 2. Section 3 describes specifications of the observation instruments and the data acquisition systems. Observation periods are also listed in Section 3. Format of the compiled digital data is shown in Section 4. Summary plots in the period of January 1-December 31, 1999 are given in the Appendix.

All-sky imager observation data, magnetograms and summary plots of the monitoring data are available to users on request. The request should be addressed to.

World Data Center for Aurora  
National Institute of Polar Research  
9-10, Kaga 1-chome, Itabashi-ku,  
Tokyo 173-8515, Japan

Digital and analog data described here are available to researchers who will do collaborative studies with the upper atmosphere physics group of NIPR. The request should be addressed to

Upper Atmosphere Physics Research Division  
National Institute of Polar Research  
9-10, Kaga 1-chome, Itabashi-ku,  
Tokyo 173-8515, Japan.

## **2. Upper Atmosphere Physics Monitoring (UAPM) System**

A real-time digital data acquisition system for the upper atmosphere physics observation was constructed at Syowa Station in January 1981 (Sato *et al.*, 1984) Data obtained from the system have been collected and published annually in the JARE Data Reports (Upper Atmosphere Physics) (Sato *et al.*, 1984, 1991 ; Fujii *et al.*, 1985, 1994; Sakurai *et al.*, 1985, Ono *et al.*, 1986, 1993; Yamagishi *et al.*, 1987, Kikuchi *et al.*, 1988; Miyaoka *et al.*, 1990, Kadokura *et al.*, 1992; Yamazaki *et al.*, 1995; Tonegawa *et al.*, 1996, Obara *et al.*, 1996; Arisawa *et al.*, 1997; Kawana *et al.*, 1998, Takeuchi *et al.*, 1999; Okano *et al.*, 2000) This report is the 19th of this series

A block diagram of the system, including other ground observations, is shown in Fig 1 The sensors for measuring weak natural electromagnetic waves such as ELF-VLF emissions, the three components of ULF magnetic pulsations and cosmic radio noise absorption (CNA) have been placed at a remote station on West Ongul Island, located about 5 km from Syowa Station in order to avoid man-made electromagnetic interference Data of the magnetic pulsations and CNA are transmitted continuously to Syowa Station by a PCM telemeter in VHF band. Wide-band signals of ELF-VLF emissions are transmitted to Syowa Station through an FM telemeter in UHF band

At the remote station, the electric power which drives all the instruments has been supplied by a solar battery system with maximum output power of 530 W since February 1985 An additional solar battery system with maximum power of 365 W was installed in January 1987 to reinforce the original battery system. The solar battery system consists of eighteen rechargeable car batteries (200 Ah each), five solar panels and three controllers in total During winter when no sunlight is available, these batteries are charged manually about once a month by using a 10 kVA

diesel-engine dynamo, which was installed in 1992 instead of the previous 16 kVA one.

The fluxgate and proton magnetometer sensors are placed at Syowa Station on East Ongul Island, about 150 m apart from the Data Processing Building. All the auroral photometric instruments are placed on the roof of the building, and the data acquisition facilities are installed inside the building. All the outputs obtained from the observation instruments except the auroral photometric ones are transferred to the matrix terminal board and then recorded with pen recorders, analog data recorders and a computer system. These data had been recorded simultaneously with two sets of the TEAC DR-200 digital data logger systems since January 1987 and with the Accurate Timing data Logging and Analysis support System (ATLAS) since February 1997. Recording by the TEAC systems was terminated in January 1999, and ATLAS succeeded them since then. An 8 mm video tape recorder is used to record wide-band VLF emissions, and 24-hour data can be stored on one volume of 8 mm video tape.

Universal time (UT) is supplied from a precise time-keeping system. This system consists of a GPS satellite timing receiver, a quartz frequency standard with a stability of  $2 \times 10^{-11}$ /day, and time code generators. The time code generators supply the IRIG-A, -B and slow codes for analog data recorders and the 36-bit BCD code for the digital recording systems, respectively. The absolute accuracy of this system is estimated to be about 1 ms.

### 3. Specifications of Instruments

#### 3.1. Geomagnetism

##### (1) *Magnetogram*

Magnetic variations were measured by a three-axis fluxgate magnetometer. Full scale ranges were +1250 to -3750 nT for H-component and  $\pm 2500$  nT for D- and Z- components, respectively, with the frequency response of DC–2 Hz and noise levels less than 0.5 nT. The magnetometer data were recorded in digital form at the sampling rate of 1 Hz. The H-component data were also recorded on a chart recorder and an R-950L long-term analog data recorder.

##### (2) *Total force of the geomagnetic field*

The total force observations were made once per month on a geomagnetically quiet day using a portable proton magnetometer, which is unable to be linked with the UAPM system. The results are listed in Table 1.

##### (3) *ULF magnetic pulsations*

The H-, D-, and Z-components of ULF magnetic pulsations are detected by three sets of search coil magnetometers. The search coil sensors have copper wires (0.4 mm $\phi$ , 40000 turns each) wound around permalloy cores (1 cm in diameter  $\times$  100 cm in length). Measurable intensity range of the magnetometer is 0.001–5 nT/s and the frequency response is 0.001–3 Hz. The search coil

magnetometers are installed at the remote station on West Ongul Island. The output signals transmitted by the PCM telemeter are recorded on a chart recorder and a digital data recorder. The sampling frequency of the digital data is 10 Hz and 1 Hz for each component.

(4) *Base line of the magnetic field and K-index*

Base line values of the magnetic field were observed about once or twice per month during a magnetically quiet day. K-indices are calculated for every 3-hour interval measuring the amplitudes of the H- and D-component magnetic fields from the quiet-day variations. The definition of the K-indices at Syowa Station is as follows:

<u>K-index</u>	<u>Deviation</u>	<u>K-index</u>	<u>Deviation</u>
0	0 – 25 nT	5	350 – 600 nT
1	25 – 50	6	600 – 1000
2	50 – 100	7	1000 – 1660
3	100 – 200	8	1660 – 2500
4	200 – 350	9	2500 and more

The ordinary magnetogram is also available on chart papers with a recording speed of 5 cm/hr. The sensitivity of each component on the chart papers is about 100 nT/cm. Table 2 gives the baseline values and K-indices at Syowa Station in February 1999 – January 2000. Inquiries or requests for the data copies of the magnetic field measurements should be addressed to World Data Center for Aurora in NIPR.

### 3.2. ELF-VLF waves

The natural ELF-VLF wave receiving system at the remote station has consisted of a triangle-shaped three-turn-loop antenna (10 m in height, 20 m in the bottom side), a pre-amplifier and a main amplifier with gains of 60 and 40 dB, respectively. The ELF-VLF wave intensities at the frequency bands of 0.35, 0.75, 1.2, 2, 4, 8, 30, 60, 95 kHz were obtained from wide band waveforms using a 9-channel filter bank and detectors. The ELF-VLF emissions within the intensity range of  $10^{-17}$  to  $10^{-13}$  W/m<sup>2</sup> Hz were detectable with this system. These data were recorded continuously in digital form at the sampling rate of 1 or 10 Hz. Some of the wide-band ELF-VLF signals up to 10 kHz were recorded on 8 mm video tape recorders. The wide-band recording was executed during 900 - 1300 UT on Sunday - Friday.

### 3.3. Ionosphere

Cosmic noise absorption at 30 MHz was observed with a broad-beam riometer, which has been installed at the remote station on West Ongul Island since 1981. Its beam half-width is 60°. A receiver used is made by La Jolla Science, and bandwidth and time constant are 150 kHz and 0.25 s, respectively. The riometer data were recorded in digital form at the sampling rate of 1 Hz in the UAPM system.

Data of ionospheric vertical sounders, broad-beam riometers (20 and 30 MHz), HF field strength receivers (8 and 10 MHz) and the VHF auroral radar (50 and 112 MHz) were recorded with other observation systems at Syowa Station, and the observational results have been published in another JARE Data Report (Ionosphere) Inquiries and requests for the data copies are to be addressed to:

World Data Center for Ionosphere  
Communications Research Laboratory  
Ministry of Posts and Telecommunications  
2-1, Nukui-Kitamachi 4-chome, Koganei-shi,  
Tokyo 184-8795, Japan.

### 3.4. Aurora

#### (1) *CCD all-sky imager*

All-sky observation of aurora was made by a CCD all-sky imager which was installed at Syowa Station by JARE39. Panchromatic auroral images are taken every twenty seconds with an exposure time of three to five seconds. Image data are saved in a DLT (digital linear tape). An observation list for the CCD all-sky imager is given in Table 3. Inquiries or requests for the all-sky data should be addressed to World Data Center for Aurora in NIPR. Observation by the film-type all-sky camera which have been operated until the end of the 1997 season was terminated on April 8, 1998.

#### (2) *Aurora TV camera*

All-sky observation of aurora was also made by an all-sky TV camera newly introduced at Syowa Station by JARE40. The TV camera consists of an image intensifier and an interline CCD camera. Video signal from the CCD camera is recorded in S-VHS video tapes. Inquiries or requests for the all-sky data should be addressed to World Data Center for Aurora in NIPR.

#### (3) *Meridian-scanning photometer*

Auroral emissions at the wavelengths of 557.7 nm (OI), 630.0 nm (OI) and 486.1 nm ( $H\beta$ ) were observed by a meridian-scanning photometer installed in 1987. The interference filter for  $H\beta$  was tilted with 1 s period, measuring the Doppler effect of the auroral  $H\beta$  emission. The field of view of the photometer is  $3^\circ$  for OI 557.7 nm and 630.0 nm, and  $5^\circ$  for  $H\beta$ . A scan along a meridian from the poleward horizon to the equatorward horizon requires 30 s. Observations were carried out during 91 clear nights from March 17 until October 15 in 1998. Calibration using a standard light source was executed at every observation night. The meridian-scanning photometer data were recorded with a digital data logger (TEAC DR-200) at a sampling frequency of 10-25 Hz through a line-approximate logarithmic amplifier, and monitored with a pen-recorder (6 ch RECTI-GRAPH). Due to a trouble in the instrument, both scanning and tilting angle data were not recorded.

## 4. Compiled Digital Data Format

MO media has been added since 1998 recorded by ATLAS (AT compatible computer with QNX operating system) This system has GPS clock and 16bit straight binary A/D converter (from -10V to 10V). Data in MO are written by Common Data Format (CDF) based on NASA NSSDC (see [1] or [2] for more detail of CDF). Each record has one time stamp and 16 kinds of data. Variable names of CDF for each data are follows,

EPOCH: Time stamp (unit: CDF Epoch)

MGFH: H component of flux gate magnet meter

MGFD: D component of flux gate magnet meter

MGFZ: Z component of flux gate magnet meter

ULFH: H component of induction coil

ULFD: D component of induction coil

ULFZ: Z component of induction coil

CAN: CNA

VLF350: Intensity of natural VLF wave at 350Hz

VLF750: Intensity of natural VLF wave at 750Hz

VLF1.2k: Intensity of natural VLF wave at 1.2kHz

VLF2.0k: Intensity of natural VLF wave at 2.0kHz

VLF4.0k: Intensity of natural VLF wave at 4.0kHz

VLF8.0k: Intensity of natural VLF wave at 8.0kHz

VLF30k: Intensity of natural VLF wave at 30kHz

VLF60k: Intensity of natural VLF wave at 60kHz

VLF95k: Intensity of natural VLF wave at 95kHz.

Each CDF valuable has 5 attributes. The names of attributes and characteristics are as follows;

Attributes (based on CDF standard attribute name)

VALIDMIN: Minimum valid value of raw AD data (usually, 0).

VALIDMAX: Maximum valid value of raw AD data (usually, 65534)

SCALEMIN: Minimum value as unit for VALIDMIN

SCALEMAX: Maximum value as unit for VALIDMAX

UNIT: Unit (e.g. nT, V/mHz, dB) written by characters)

Using these valuables, user can convert from A/D value to physical value by the following equation.

$$\begin{aligned} \text{(Physical value)} = & \text{SCALEMIN} + \\ & (\text{SCALEMAX} - \text{SCALEMIN}) / (\text{VALIDMAX} - \text{VALIDMIN}) * \\ & ((\text{Variable data}) - \text{VALIDMIN}) \end{aligned}$$

- [1] CDF User's Guide (Version2.6) NASA/GSFC/NSSDC,  
[2] [http://nssdc.gsfc.nasa.gov/cdf/cdf\\_home.html](http://nssdc.gsfc.nasa.gov/cdf/cdf_home.html)

## Acknowledgments

We would like to acknowledge all the members of the 40th Japanese Antarctic Research Expedition (JARE-40) for their support to the upper atmosphere physics observations at Syowa Station. The publication of this report was supported by the Upper Atmosphere Physics Research Division, World Data Center for Aurora and the Information Science Center of the National Institute of Polar Research.

## References

- Arisawa, T., Kato, Y., Otaka, K., Inamori, Y., Kaneko, M. and Taguchi, M. (1997): Upper atmosphere physics data obtained at Syowa Station in 1995. JARE Data Rep., **225** (Upper Atmos. Phys.15), 204p.
- Fujii, R., Sato, N and Fukunishi, H. (1985): Upper atmosphere physics data, Syowa Station, 1982. JARE Data Rep., **105** (Upper Atmos. Phys. 2), 266p.
- Fujii, R., Kotake, N., Murata, I., Nozaki, K., Umetsu, M., Makita, K., Minatoya, H. and Yukimatu, A. (1994): Upper atmosphere physics (UAP) data obtained at Syowa and Asuka Stations in 1991. JARE Data Rep , **193** (Upper Atmos. Phys. 11), 208p.
- Kadokura, A., Uchida, K., Kurihara, N., Kimura, K., Okamura, H., Ariyoshi, H., Yukimatsu, A. and Ejiri, M. (1992): Upper atmosphere physics data, Syowa and Asuka Stations, 1989. JARE Data Rep., **171** (Upper Atmos. Phys. 9), 335p.
- Kawana, S., Kikuchi, M, Sakanoi, T., Yumisashi, I., and Taguchi, M. (1998): Upper atmosphere physics data obtained at Syowa Station in 1996. JARE Data Rep., **233** (Upper Atmos. Phys.16), 202p.
- Kikuchi, T , Ohwada, T., Oginasa, T., Uchida, K., Sakurai, H., Yamagishi, H. and Sato, N. (1988). Upper atmosphere physics data, Syowa Station, 1986. JARE Data Rep., **138** (Upper Atmos. Phys. 6), 276p.
- Miyaoka, H., Uchida, K., Mukai, H., Saito, H., Akamatsu, J., Shibuya, K., Sakai, R., Ayukawa, M. and Sato, N. (1990): Upper atmosphere physics data, Syowa and Asuka Stations, 1987 JARE Data Rep., **159** (Upper Atmos. Phys. 7), 306p.
- Obara, N., Wakino, Y , Kubota, M., Iwasaki, K., Nishimura, H. and Kadokura, A. (1996): Upper atmosphere physics data obtained at Syowa Station in 1994. JARE Data Rep., **209** (Upper Atmos. Phys. 14), 208p.
- Okano, S., Meki, K., Sakanoi, K., Kusano, K., Kikuchi, M, Kadokura, A , and Taguchi, M. . (2000): Upper atmosphere physics data obtained at Syowa Station in 1998. JARE Data Rep.,

250 (Upper Atmos. Phys 18), 200p

- Ono, T , Tsunomura, S , Ejiri, M , Fujii, R and Sato, N (1986): Upper atmosphere physics data, Syowa Station, 1984 JARE Data Rep., 118 (Upper Atmos. Phys 4), 271p
- Ono, T , Nakajima, H , Satoh, M , Ohtaka, K , Kawahara, M. and Kumade, A (1993). Upper atmosphere physics data, Syowa and Asuka Stations, 1990 JARE Data Rep., 186 (Upper Atmos Phys 10), 222p.
- Sakurai, H , Shibasaki, K , Fujii, R and Sato, N (1985) Upper atmosphere physics data, Syowa Station, 1983 JARE Data Rep., 108 (Upper Atmos. Phys 3), 212p
- Sato, N , Fujii, R., Fukunishi, H and Nakajima, D (1984). Upper atmosphere physics data, Syowa Station, 1981. JARE Data Rep , 93 (Upper Atmos Phys 1), 206p
- Sato, N , Uchida, K , Saka, O , Yamaguchi, K., Iguchi, S., Aoki, T and Miyaoka, H. (1991): Upper atmosphere physics data, Syowa and Asuka Stations, 1988 JARE Data Rep , 169 (Upper Atmos. Phys 8), 212p.
- Takeuchi, S , Ookawa, T., Setoguchi, T , Ozeki, J , Kikuchi, M , Kadokura, A. and Taguchi, M (1999). Upper atmosphere physics data obtained at Syowa Station in 1997 JARE Data Rep , 243 (Upper Atmos Phys.17), 204p.
- Tonegawa, Y , Rokuyama, K , Makita, Y., Yang H , Kadokura, A and Sato, N (1996): Upper atmosphere physics data obtained at Syowa Station in 1993 JARE Data Rep , 208 (Upper Atmos. Phys. 13), 202p
- Uchida, K , Tonegawa, Y , Fujii, R. and Sato, N (1988): Computer compilatory process of the data acquired by the conjugate observation system in Iceland. Nankyoku Shiryo (Antarct. Rec.), 32, 238-257 (in Japanese with English abstract).
- Yamagishi, H. (1990): Development of Optical Disk data base system for Syowa Station-Iceland geomagnetically conjugate observation Nankyoku Shiryo (Antarct Rec.), 34, 242-262 (in Japanese with English abstract)
- Yamagishi, H , Ayukawa, M , Matsumura, S , Sakurai, H. and Sato, N. (1987). Upper atmosphere physics data, Syowa Station, 1985 JARE Data Rep , 128 (Upper Atmos Phys. 5), 272p.
- Yamazaki, I , Takahashi, Y., Mineno, H., Kamata, M , Ogawa, Y. and Kadokura, A. (1995): Upper atmosphere physics data obtained at Syowa Stations in 1992. JARE Data Rep., 205 (Upper Atmos Phys. 12), 207p.



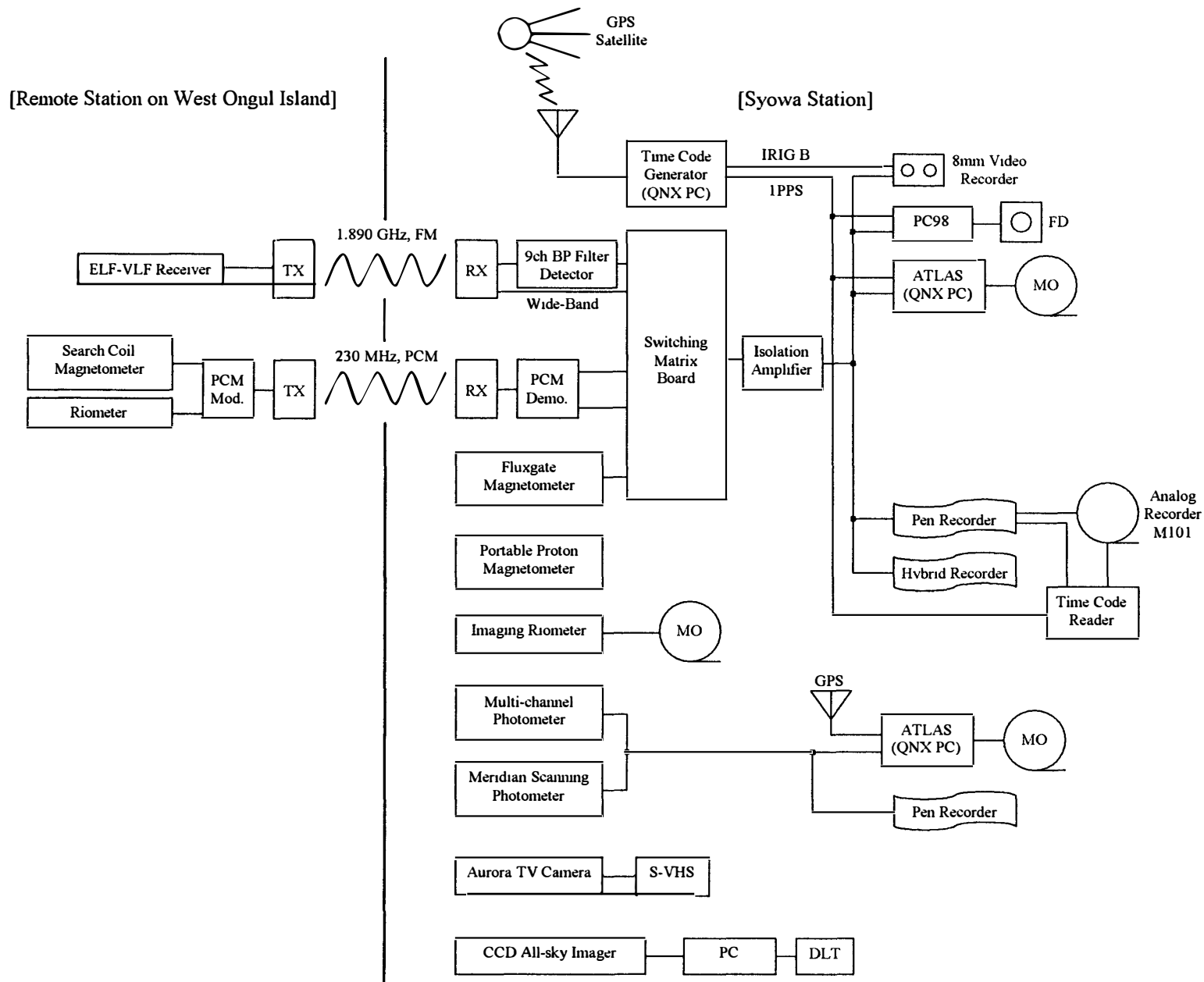

Fig. 1. Block diagram of the "Upper Atmosphere Physics" monitoring system at Syowa Station in 1999.

Table 1. Baseline values of the geomagnetic field at Syowa Station in March 1999–February 2000.

DATE	TIME hh mm	DECLINATION (deg.min)	TIME hh mm	DIP ANGLE (deg.min)	TOTAL (nT)	HORIZONTAL (nT)	VERTICAL (nT)
1999 3/12	10 58	-48 09 07	11 45	-63.53 43	43438.6	19147.8	-38990.7
	11 03	-48 09.19	11 50	-63 53 46	43448.6	19156.8	-38997.5
	11 08	-48:09 22	11.54	-63.53 36	43457.6	19165.3	-39003.3
	11.12	-48.09 13	11 58	-63 53.36	43465.1	19175.8	-39006.5
mean	11:05	-48:09.15	11.52	-63.53.40	43452.3	19161.4	-38999.5
1999 3/25	12.04	-48.09.07	12.35	-63 53 43	43439.7	19159.1	-38986.4
	12.09	-48 09.19	12 39	-63 53 46	43438.3	19157.8	-38985.4
	12.13	-48.09 22	12 44	-63 53 36	43438.6	19157.6	-38985.8
	12:17	-48.09.13	12:49	-63.53 36	43439.6	19157.1	-38987.2
mean	12:10	-48:09.15	12:42	-63.53 40	43439.3	19157.9	-38986.2
1999 4/22	11.58	-48:09 07	12 25	-63.53 43	43447.6	19173.0	-38988.3
	12 01	-48 09 19	12:29	-63 53 46	43448.5	19170.9	-38990.3
	12 04	-48:09.22	12 33	-63.53 36	43449.2	19171.6	-38990.8
	12 09	-48:09.13	12.37	-63.53 36	43449.3	19171.2	-38991.1
mean	12 03	-48:09 15	12.31	-63 53.40	43448.6	19171.7	-38990.1
1999 5/29	10 58	-48.09.07	11:38	-63 53 43	43433.6	19166.9	-38975.7
	11:06	-48.09.19	11 42	-63 53 46	43433.5	19167.5	-38975.3
	11 09	-48:09.22	11 47	-63 53 36	43433.9	19165.8	-38976.6
	11 13	-48:09 13	11 51	-63.53 36	43434.7	19166.0	-38977.4
mean	11.06	-48:09 15	11 44	-63.53 40	43434.0	19166.5	-38976.2
1999 7/ 4	10:04	-48.09 07	10 30	-63 53 43	43430.0	19170.6	-38969.9
	10 08	-48 09 19	10.35	-63 53 46	43430.6	19171.2	-38970.3
	10 11	-48.09 22	10 38	-63 53 36	43430.7	19170.8	-38970.6
	10 14	-48.09 13	10 41	-63 53 36	43430.6	19170.0	-38970.8
mean	10 09	-48 09 15	10 36	-63 53 40	43430.3	19170.7	-38970.4
1999 8/ 3	9:21	-48.09.07	9 55	-63 53 43	43419.6	19168.5	-38959.3
	9 32	-48:09 19	9 59	-63.53 46	43419.0	19166.9	-38959.4
	9 37	-48:09 22	10 04	-63 53.36	43421.5	19168.9	-38961.2
	9 41	-48.09 13	10 10	-63.53 36	43424.0	19170.7	-38963.1
mean	9:32	-48.09 15	10 02	-63.53 40	43421.2	19168.8	-38960.8
1999 8/26	11 34	-48 09 07	12 05	-63.53 43	43430.0	19188.3	-38961.1
	11 38	-48.09 19	12 09	-63.53 46	43422.2	19182.9	-38955.2
	11:42	-48.09 22	12 13	-63.53 36	43418.1	19178.3	-38952.8
	11.46	-48:09 13	12 18	-63 53 36	43418.3	19177.3	-38953.6
mean	11 40	-48 09 15	12:11	-63.53.40	43423.1	19181.7	-38955.7
1999 9/24	7 57	-48.09.07	8 21	-63 53 43	43434.3	19168.5	-38975.7
	8:00	-48 09 19	8 25	-63.53 46	43436.3	19169.9	-38977.3
	8 04	-48:09 22	8 29	-63 53.36	43436.6	19169.2	-38977.9
	8.08	-48:09 13	8:33	-63 53 36	43436.3	19168.8	-38977.8
mean	8:02	-48:09.15	8:27	-63 53 40	43435.8	19169.1	-38977.2
1999 11/ 2	11:22	-48.09.07	11.43	-63.53 43	43436.5	19170.3	-38977.3
	11:25	-48.09.19	11.46	-63.53.46	43412.6	19159.4	-38956.0
	11:28	-48 09 22	11.49	-63 53.36	43363.6	19138.4	-38911.7
	11:32	-48:09 13	11.53	-63 53 36	43338.4	19127.6	-38888.9
mean	11 26	-48:09 15	11:47	-63 53 40	43387.7	19148.9	-38933.5
1999 11/27	6:36	-48.09.07	7.04	-63.53 43	43417.7	19220.9	-38931.4
	6 40	-48 09.19	7:08	-63 53 46	43414.9	19218.2	-38929.6
	6 44	-48 09.22	7 12	-63 53 36	43412.8	19214.8	-38928.9
	6:48	-48:09 13	7.17	-63.53 36	43407.7	19211.0	-38925.2
mean	6:42	-48:09 15	7.10	-63 53 40	43413.0	19216.2	-38928.8

DATE	TIME hh:mm	DECLINATION (deg:min)	TIME hh:mm	DIP ANGLE (deg:min)	TOTAL (nT)	HORIZONTAL (nT)	VERTICAL (nT)
1999 12/22	10:42	-48:09:07	11:13	-63:53:43	43393.4	19158.7	-38934.9
	10:48	-48:09:19	11:17	-63:53:46	43390.6	19157.4	-38932.5
	10:52	-48:09:22	11:21	-63:53:36	43390.2	19150.5	-38935.4
	10:57	-48:09:13	11:25	-63:53:36	43391.9	19153.5	-38935.8
mean	10:50	-48:09:15	11:19	-63:53:40	43391.9	19155.0	-38934.7
2000 2/2	7:15	-48:09:07	7:38	-63:53:43	43398.7	19183.1	-38928.9
	7:19	-48:09:19	7:42	-63:53:46	43394.8	19179.8	-38926.1
	7:22	-48:09:22	7:45	-63:53:36	43391.8	19183.9	-38920.8
	7:25	-48:09:13	7:48	-63:53:36	43391.8	19184.7	-38920.4
mean	7:20	-48:09:15	7:43	-63:53:40	43394.6	19182.8	-38924.0

Table 2. *K*-indices at Syowa Station in February 1999–January 2000.

	FEBRUARY	MARCH	APRIL	MAY	JUNE	JULY	AUGUST	SEPTEMBER	OCTOBER	NOVEMBER	DECEMBER	JANUARY
1	1111 1000	6652 3555	5521 1112	5653 2255	2011 0212	2221 0133	5411 1000	5553 3254	3322 2233	4423 3133	2221 0222	5643 3365
2	1111 0012	6442 3344	3431 2233	4443 2155	5112 1014	4453 3345	2431 1323	4332 1233	4452 2235	4322 0225	3121 2133	4433 3355
3	3122 2222	3433 2475	4322 1245	5422 2121	4211 1000	5342 1301	4111 0002	3543 3213	4322 2322	5212 1122	5523 4423	5423 3233
4	3321 2333	3643 3446	5331 2245	2121 1013	3321 2113	0000 0011	3452 0112	4532 1223	2552 2356	3421 0112	5444 4554	3326 -334
5	4322 2433	5532 2423	5332 3212	1011 0213	2001 0022	0000 0003	4412 1005	3422 1134	4432 2335	1111 0114	5453 3455	5432 --55
6	2323 4342	4421 1356	6531 1114	3422 2223	1001 0000	3341 0312	1112 1534	2121 1022	1122 1021	3222 1343	4533 4334	3323 5433
7	3442 2424	5553 2455	5432 2354	5421 1123	0110 0115	0000 0220	4322 1135	3223 3156	3221 0111	5573 5535	4332 3344	4422 3354
8	4312 1200	3432 1246	2111 1433	2311 1112	3552 1211	3002 1333	2011 1245	3111 1225	4422 2124	4534 4365	3323 3335	4222 3310
9	3210 1124	4542 4354	3311 1001	3211 1000	5531 0345	5111 0012	6453 3200	5312 2112	2121 1125	4554 4354	4423 3234	3312 1112
10	3321 1233	6754 2233	2232 2346	3100 0000	3210 0000	2010 0022	0000 0102	3433 2235	4553 4454	4432 3365	2322 3343	4421 1233
11	5332 4433	5432 3322	4532 2222	0000 0000	0011 1044	2011 0014	5401 0012	6622 1102	5552 3357	4662 2465	3221 3311	4323 4465
12	4343 4443	3222 2243	5112 1100	0121 1334	5500 0123	4642 1223	1132 1015	5424 3476	6655 3455	4522 2363	4422 2345	4432 1223
13	4322 2123	2112 2224	0011 1012	4653 4423	4301 0032	3311 0021	4441 2123	5654 3555	5443 3345	5552 4555	5565 4521	3432 3225
14	2102 3322	4412 3325	1122 1111	4342 1103	1110 0002	0000 0032	2211 0000	6663 2334	5543 4445	3332 3235	2227 1211	5321 2322
15	5432 3223	4543 2212	2011 0001	3211 1124	0000 1102	3322 2223	0112 2453	5445 3321	6653 4344	3212 2212	2221 1124	3321 1223
16	3322 1110	2121 1001	2212 2455	4111 0100	0021 1324	2111 1002	3134 3456	5755 3344	5543 3465	3223 4433	4331 1224	3422 2224
17	1224 4223	1111 1111	6763 2111	0001 0101	3231 0012	1000 0000	5653 4344	4432 3343	5454 3213	3333 3445	3422 2331	3222 1011
18	4666 5666	2212 2111	5111 1111	4453 3353	0210 0104	1010 0102	6453 4346	2322 3301	2312 2233	4332 3355	2222 2333	3321 1213
19	5654 4443	1111 1344	0123 2235	5521 2225	4110 0000	3001 0000	5543 3344	3422 2124	4331 0112	4432 3235	3222 2222	2111 0234
20	2111 1133	4322 2230	5553 4333	3322 2214	0000 0000	0000 0000	5754 3346	3331 1333	1212 1110	3442 1113	1121 1123	2332 3343
21	1211 1213	1222 1110	3222 2444	4310 0101	0001 0000	2021 1541	2322 1110	2121 1335	4622 1243	4451 1334	1121 1111	2211 1112
22	3122 1134	1111 1110	2111 0112	2110 1010	0000 0003	2563 2433	1121 2356	3322 3378	7774 3455	4323 3221	2111 1111	2332 5465
23	3431 2311	0112 1123	1111 1201	3011 2120	1111 1014	5422 3232	5643 4435	4642 2212	4542 4454	2543 3345	1121 2222	6533 3312
24	2222 3321	2112 1002	4411 1111	2211 2113	2211 1021	5311 3143	5433 4225	2321 1101	6543 3356	4435 4343	3442 2222	4444 2345
25	2522 2210	0112 1234	0011 2002	5543 3124	2200 0001	4421 1124	3211 0115	3212 1110	5533 3330	3333 3333	4331 3222	4442 1333
26	0211 1100	2222 2100	1011 1144	4321 0112	3232 2242	3021 2103	3511 2345	1111 1446	3322 3344	3221 2110	3111 1112	4541 1234
27	2221 0122	2211 0004	3334 3355	3431 1124	3221 3346	3221 0010	6532 1334	6463 4556	4523 3543	1121 1111	4222 1222	4322 2334
28	1121 2365	4321 1101	5532 2346	3231 1232	2764 2123	2011 2345	5333 2226	6443 3346	3222 3475	2322 2222	4321 2235	5544 4335
29		4452 4326	4432 3357	3100 0100	2323 2100	3311 0002	4332 1235	6543 3336	5332 2133	3322 1123	4422 2323	5443 4546
30		6443 2465	6533 3346	1001 0131	0011 0011	4343 4266	3534 2546	5553 3244	3322 2225	3332 3232	222- --35	3342 3344
31		4532 2247		0001 0002		5651 1155	5532 2265		4322 1224		5645 3446	5432 3223

Table 3. Observation periods of a CCD all-sky imager at Syowa Station in 1999.

DATE	Hours (UT)									K-Index	
	h	m	s	h	m	s	h	m	s		
Feb. 28				19	26	00	~ 23	02	00	1121	2365
Mar. 9				20	06	00	~ 23	06	00	4542	4354
Mar. 13							20	11	00	2112	2224
Mar. 14	~ 00	10	00				19	51	00	4412	3325
Mar. 15	~ 00	00	00	19	37	00	~ 23	39	00	4543	2212
Mar. 17				19	17	00	~ 22	56	00	1111	1111
Mar. 18							18	51	00	2212	2111
Mar. 19	~ 00	21	00	18	41	00	~ 22	02	00	1111	1344
Mar. 22							20	15	00	1111	1110
Mar. 23	~ 00	40	00							0112	1123
Mar. 26							18	30	00	2222	2100
Mar. 27	~ 00	02	40	00	12	00	~ 01	11	00	2211	0004
Mar. 27							18	50	00		
Mar. 28	~ 01	00	00				19	56	00	4321	1101
Mar. 29	~ 01	28	00				18	33	00	4452	4326
Mar. 30	~ 01	33	00	17	37	00	~ 22	09	00	6443	2465
Apr. 3				19	37	00	~ 23	07	00	4322	1245
Apr. 7				16	45	00	~ 22	17	40	5432	2354
Apr. 7				22	36	00	~ 22	53	00		
Apr. 9				17	05	00	~ 23	59	00	3311	1001
Apr. 10				16	43	00	~ 18	00	00	2232	2346
Apr. 19							18	48	00	0123	2235
Apr. 20	~ 01	55	00							5553	4333
Apr. 22				18	04	00	~ 22	27	00	2111	0112
Apr. 24							20	03	00	4411	1111
Apr. 25	~ 01	30	00				22	49	00	0011	2002
Apr. 26	~ 03	05	00	18	53	00	~ 23	03	00	1011	1144
May 5				18	17	00	~ 20	42	00	1011	0213
May 10							16	47	00	3100	0000
May 11	~ 03	53	00	18	32	00	~ 22	42	00	0000	0000
May 12							16	47	00	0121	1334
May 13	~ 01	00	00							4653	4423
May 14				18	06	00	~ 23	38	40	4342	1103
May 15							00	00	00	3211	1124
May 15	~ 04	00	00	18	23	00	~ 21	01	00		
May 19							15	24	00	5521	2225
May 20	~ 01	30	00							3322	2214
May 24	18	39	00	~ 21	00	40	23	05	00	2211	2113
May 25	~ 04	00	00							5543	3124
Jun. 4				17	04	00	~ 23	50	00	3321	2113
Jun. 5							18	09	00	2001	0022
Jun. 6	~ 00	00	00							1001	0000
Jun. 9				19	30	00	~ 23	48	00	5531	0345
Jun. 13							20	27	00	4301	0032
Jun. 14	~ 05	01	00				17	03	00	1110	0002
Jun. 15	~ 02	50	00	18	13	00	~ 22	54	00	0000	1102
Jun. 16							18	47	00	0021	1324

DATE	Hours (UT)									K-Index	
	h	m	s	h	m	s	h	m	s		
Jun 17	~ 05	00	00							3231	0012
Jun 17	15	02	00	~ 20	33	40	20	47	00		
Jun 18	~ 02	20	40	02	33	00	~ 05	00	00	0210	0104
Jun 18							17	02	00		
Jun 19	~ 04	07	00							4110	0000
Jun 21							21	52	00	0001	0000
Jun 22	~ 03	24	00							0000	0003
Jun 23							21	06	00	1111	1014
Jun 24	~ 05	00	00							2211	1021
Jul 6							16	50	00	3341	0312
Jul 7	~ 04	00	00				18	09	00	0000	0220
Jul 8	~ 01	02	00				16	03	00	3002	1333
Jul 9	~ 05	01	00				16	09	00	5111	0012
Jul 10	~ 05	00	00				16	05	00	2010	0022
Jul 11	~ 04	30	00				17	04	00	2011	0014
Jul 12	~ 04	10	40	04	40	00	~ 04	43	00	4642	1223
Jul 12							15	01	00		
Jul 13	~ 04	31	00				15	02	00	3311	0021
Jul 14	~ 03	09	40	03	22	00	~ 04	00	00	0000	0032
Jul 14							16	04	00		
Jul 15	~ 04	00	00				22	03	00	3322	2223
Jul 16	~ 04	00	00				20	03	00	2111	1002
Jul 17	~ 02	45	00				17	03	00	1000	0000
Jul 18	~ 04	00	00				17	02	00	1010	0102
Jul 19	~ 04	02	00				17	13	00	3001	0000
Jul 20	~ 04	00	00				20	02	00	0000	0000
Jul 21	~ 04	00	00	17	02	00	~ 20	26	00	2021	1541
Jul 30							18	22	00	4343	4266
Jul 31	~ 03	58	00				15	09	00	5651	1155
Aug 1	~ 03	58	00							5411	1000
Aug 1	17	01	00	~ 22	34	40	22	45	00		
Aug 2	~ 04	00	00				17	01	00	2431	1323
Aug 3	~ 03	29	00				18	04	00	4111	0002
Aug 4	~ 02	58	00							3452	0112
Aug 4	17	02	00	~ 22	35	40	22	47	00		
Aug 5	~ 03	04	00				18	02	00	4412	1005
Aug 6	~ 03	00	00				17	06	00	1112	1534
Aug 7	~ 03	00	00							4322	1135
Aug 7	16	02	00	~ 18	39	40	19	10	00		
Aug 8	~ 00	43	40	01	03	00	~ 03	00	00	2011	1245
Aug 10							17	32	00	0000	0102
Aug 11	~ 03	30	00	17	02	00	~ 22	00	00	5401	0012
Aug 12				18	02	00	~ 03	31	00	1132	1015
Aug 15				17	25	00	~ 22	51	00	0112	2453
Aug 16							23	42	00	3134	3456
Aug 17	~ 03	40	00	20	02	00	~ 22	02	00	5653	4344
Aug 18				20	33	00	~ 23	32	00	6453	4346
Aug 20							23	41	00	5754	3346
Aug 21	~ 03	00	00				17	03	00	2322	1110

DATE	Hours (UT)									K-Index	
	h	m	s	h	m	s	h	m	s		
Aug. 22	~ 03	01	00							1121	2356
Aug. 22	17	37	00	~ 18	12	40	18	29	00		
Aug. 23	~ 02	30	00							5643	4435
Sep. 1							17	02	00	5553	3254
Sep. 2	~ 02	30	00				19	09	00	4332	1233
Sep. 3	~ 02	30	00				17	02	00	3543	3213
Sep. 4	~ 02	00	00							4532	1223
Sep. 6							17	05	00	2121	1022
Sep. 7	~ 02	00	00				17	02	00	3223	3156
Sep. 8	~ 02	00	00				20	02	00	3111	1225
Sep. 9	~ 01	34	00							5312	2112
Sep. 10				18	02	00	~ 19	40	00	3433	2235
Sep. 12							17	01	00	5424	3476
Sep. 13	~ 01	30	00				17	01	00	5654	3555
Sep. 14	~ 01	30	00				17	01	00	6663	2334
Sep. 15	~ 01	32	00				17	21	00	5445	3321
Sep. 16	~ 01	31	00				17	21	00	5755	3344
Sep. 17	~ 01	30	00	17	21	00	~ 22	53	00	4432	3343
Sep. 18							17	21	00	2322	3301
Sep. 19	~ 01	20	00				19	41	00	3422	2124
Sep. 20	~ 01	00	00				17	51	00	3331	1333
Sep. 21	~ 01	00	00							2121	1335
Sep. 29							20	04	00	6543	3336
Sep. 30	~ 00	15	00							5553	3244
Oct. 3				19	31	00	23	30	00	4322	2322
Oct. 4				18	39	00	23	30	00	2552	2356
Oct. 7				19	31	00	23	30	00	3221	0111

## Appendix

### Summary plots of the Upper Atmosphere Physics Monitoring data in 1999

- Plotted data from top:

H . northward component of the magnetic variation  
D . eastward component of the magnetic variation  
Z : downward component of the magnetic variation

- Plotting vertical scale:

H, D, Z · 100 nT/div



SYOWA magnetogram (100 nT/div)

01 Jan.1999 (DAY:001)

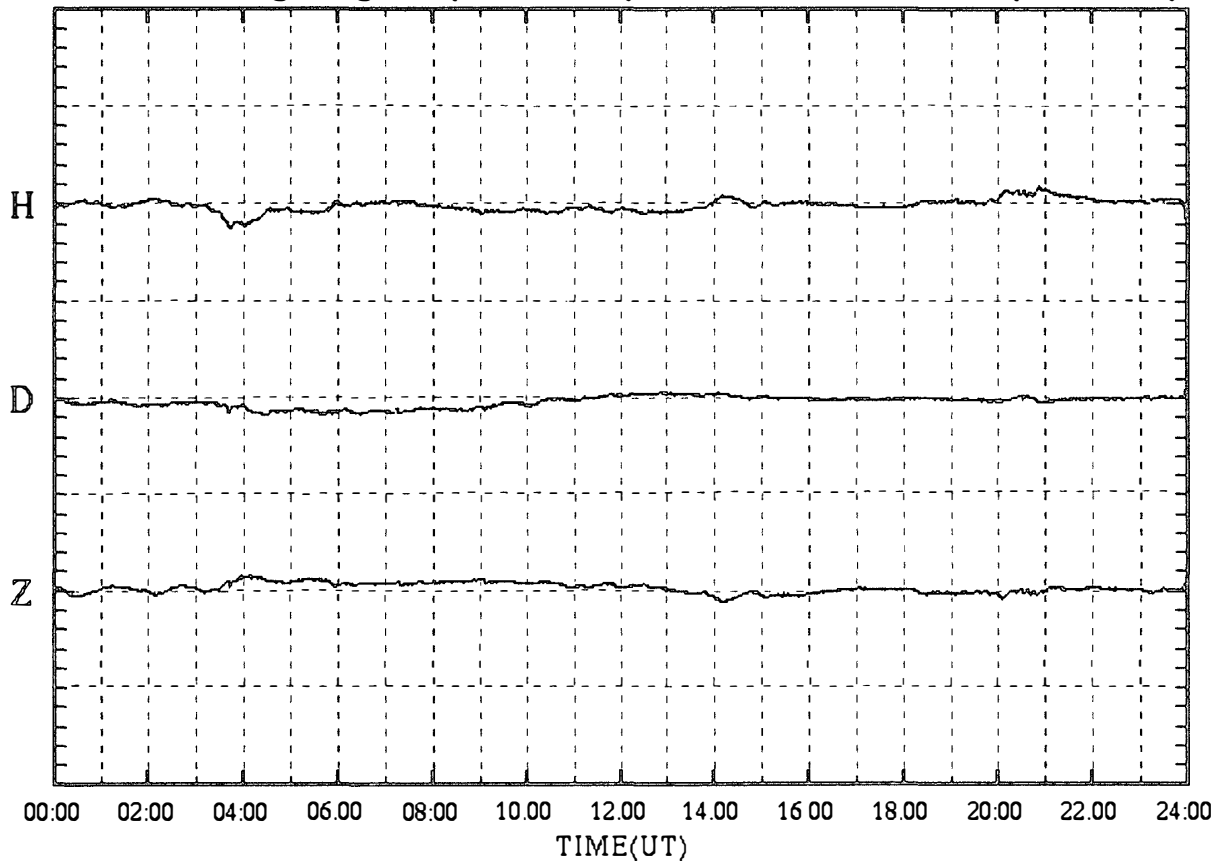

SYOWA magnetogram (100 nT/div)

02 Jan.1999 (DAY:002)

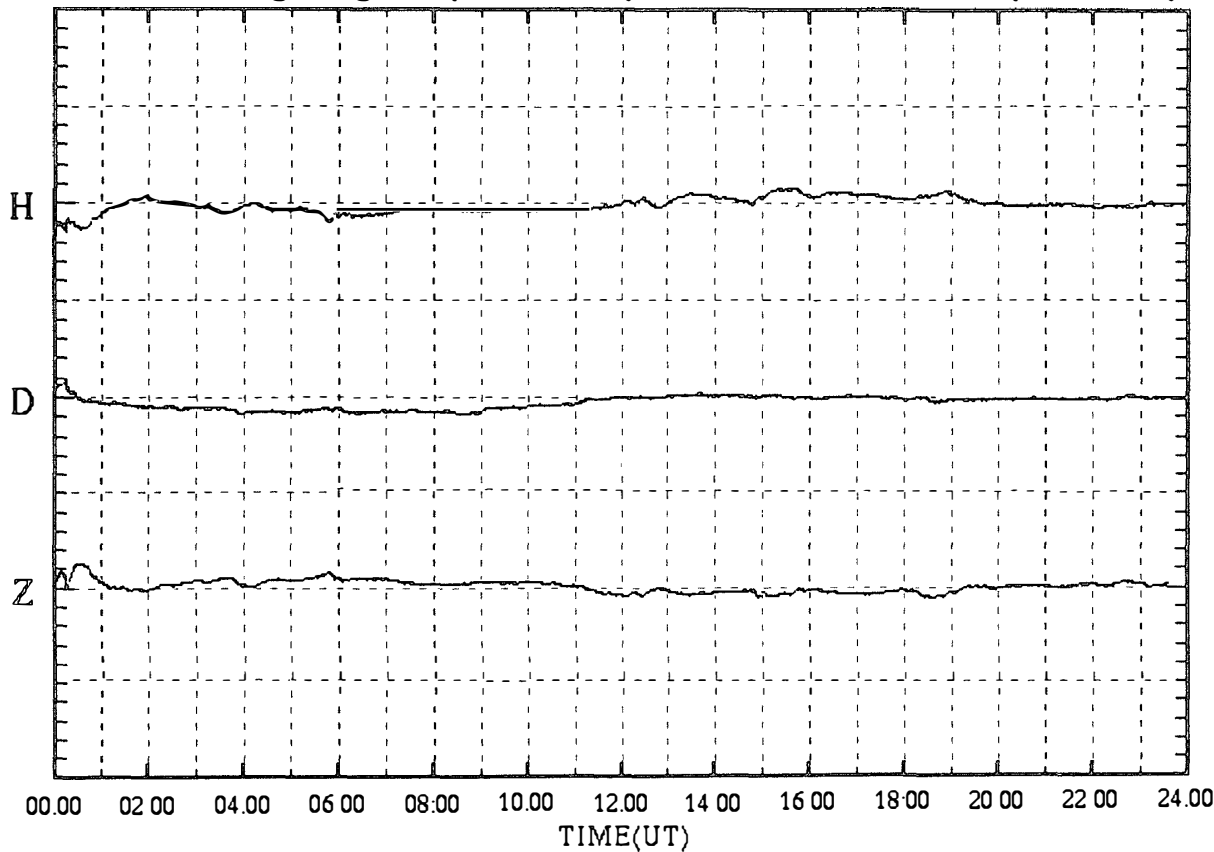

SYOWA magnetogram (100 nT/div)

03 Jan.1999 (DAY:003)

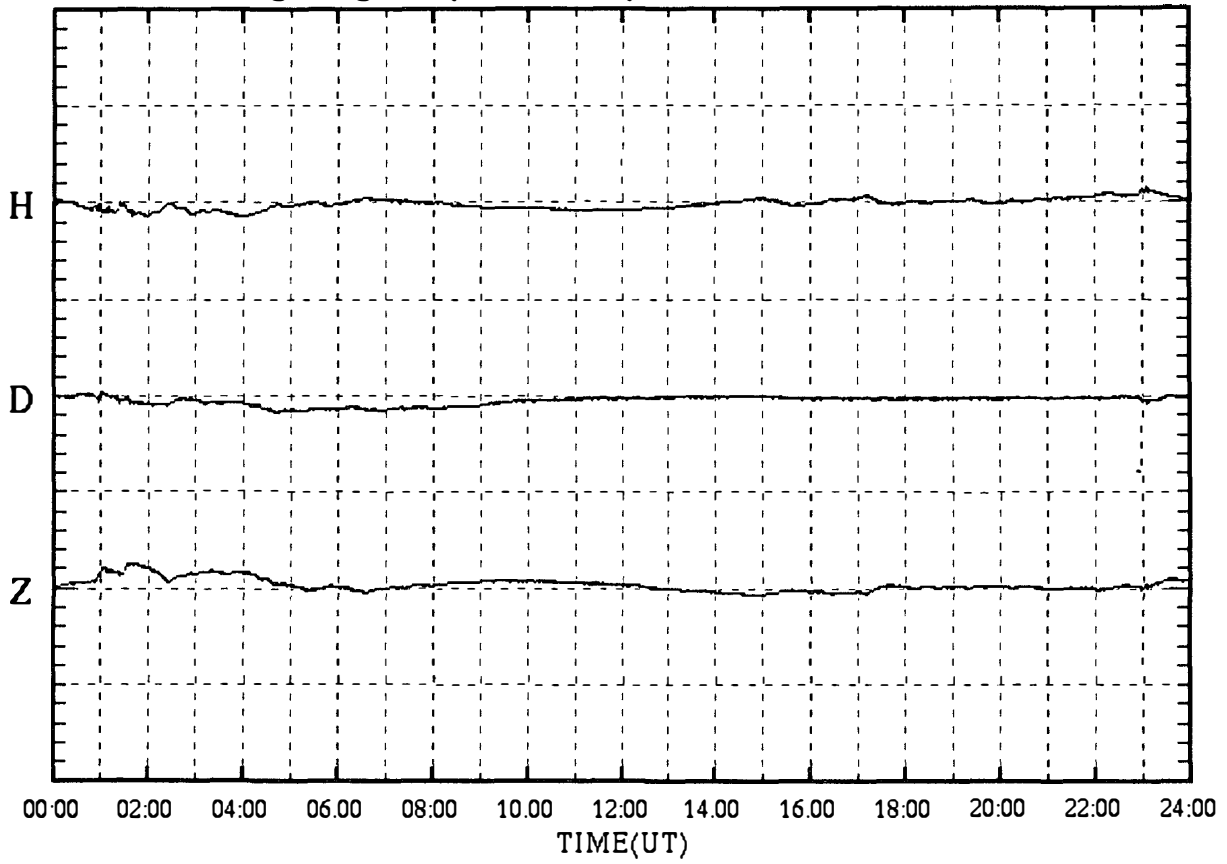

SYOWA magnetogram (100 nT/div)

04 Jan.1999 (DAY:004)

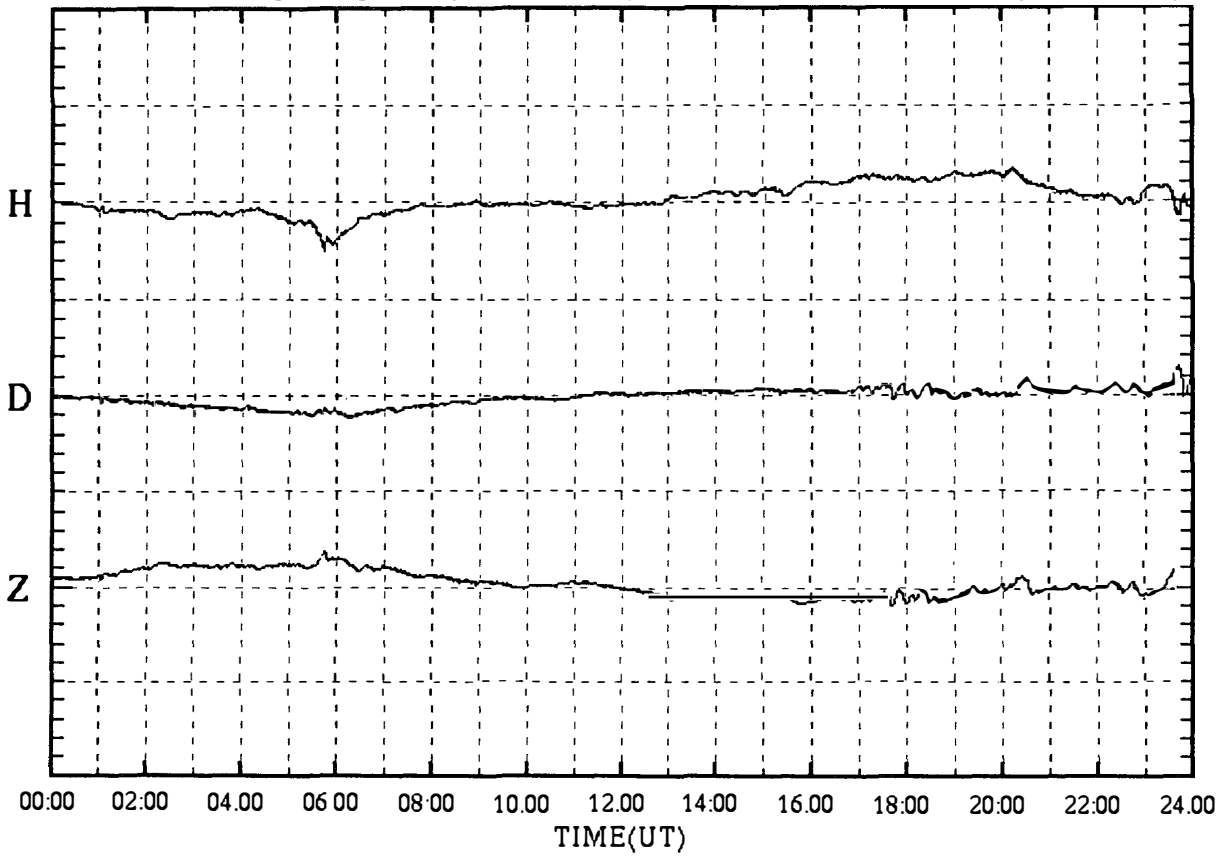

SYOWA magnetogram (100 nT/div)

05 Jan.1999 (DAY:005)

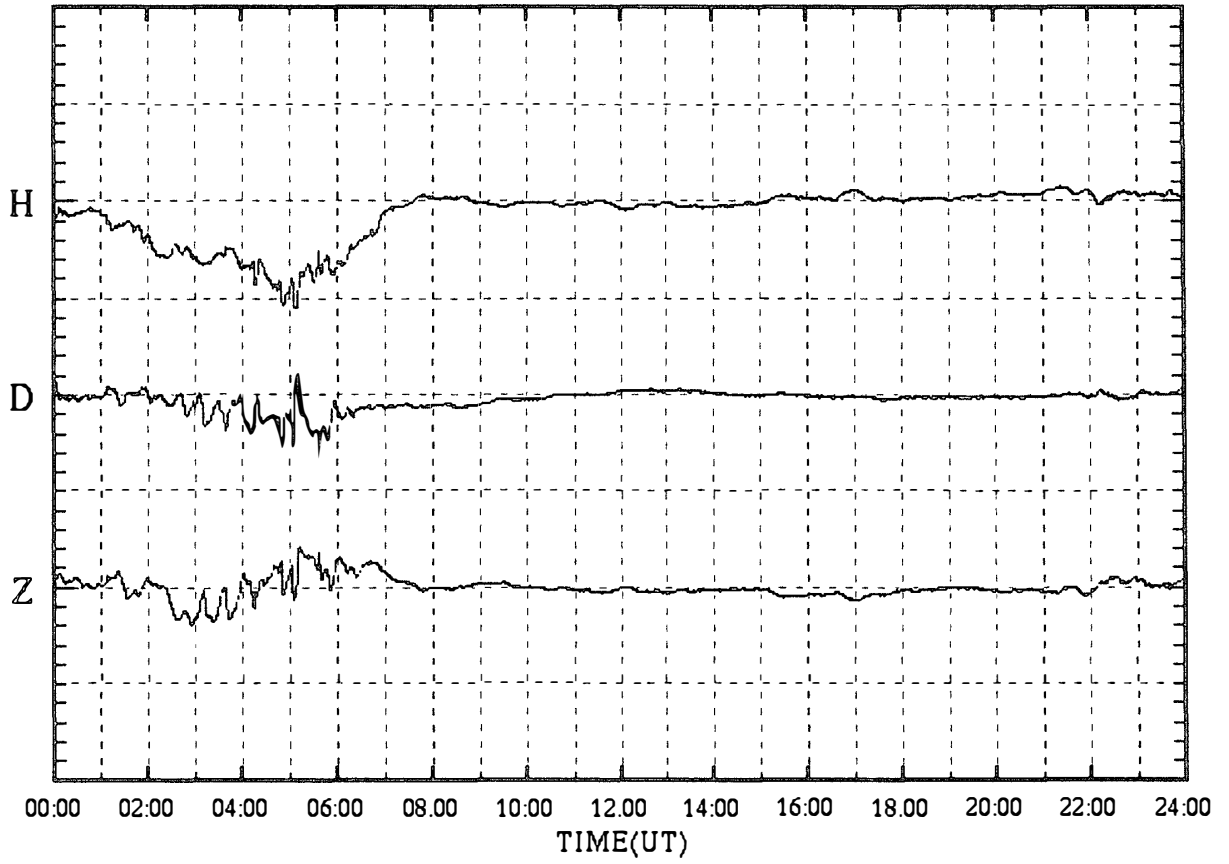

SYOWA magnetogram (100 nT/div)

06 Jan.1999 (DAY:006)

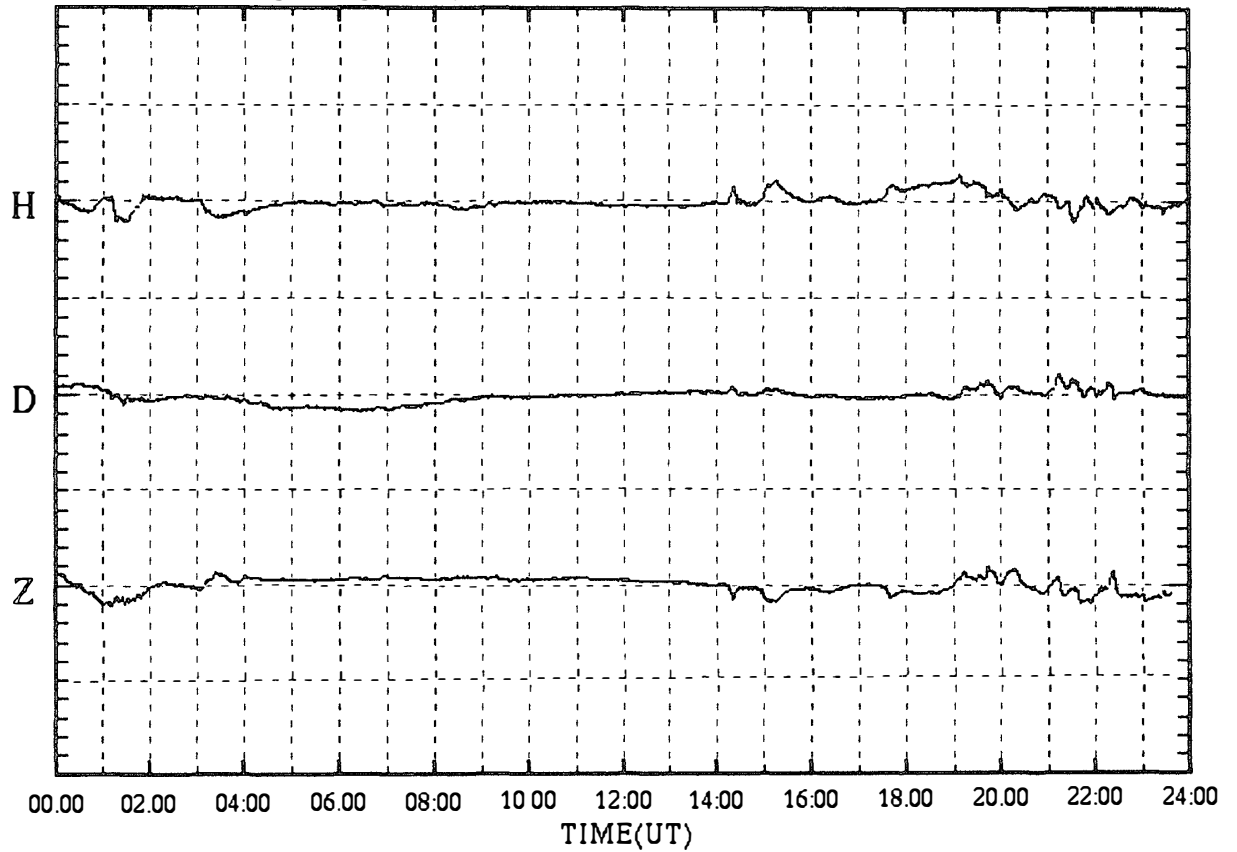

SYOWA magnetogram (100 nT/div)

07 Jan.1999 (DAY:007)

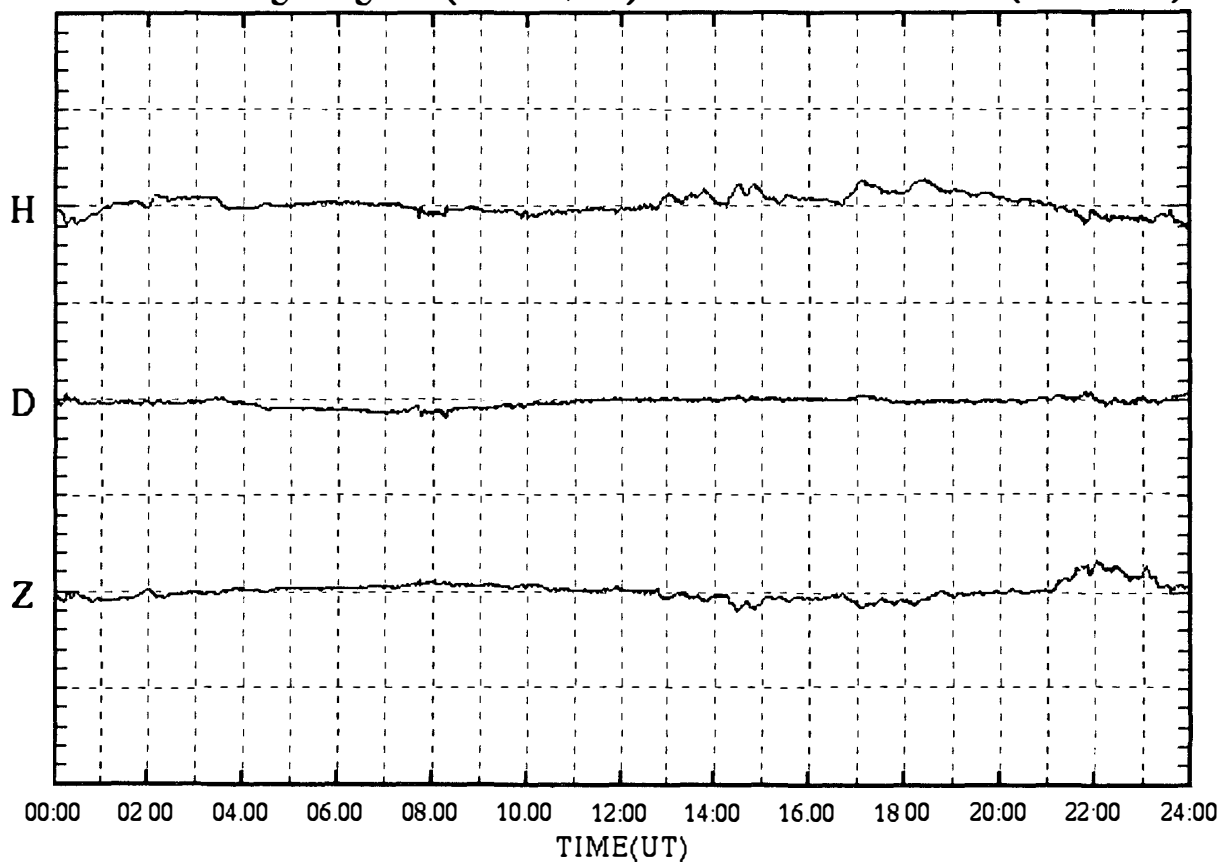

SYOWA magnetogram (100 nT/div)

08 Jan.1999 (DAY:008)

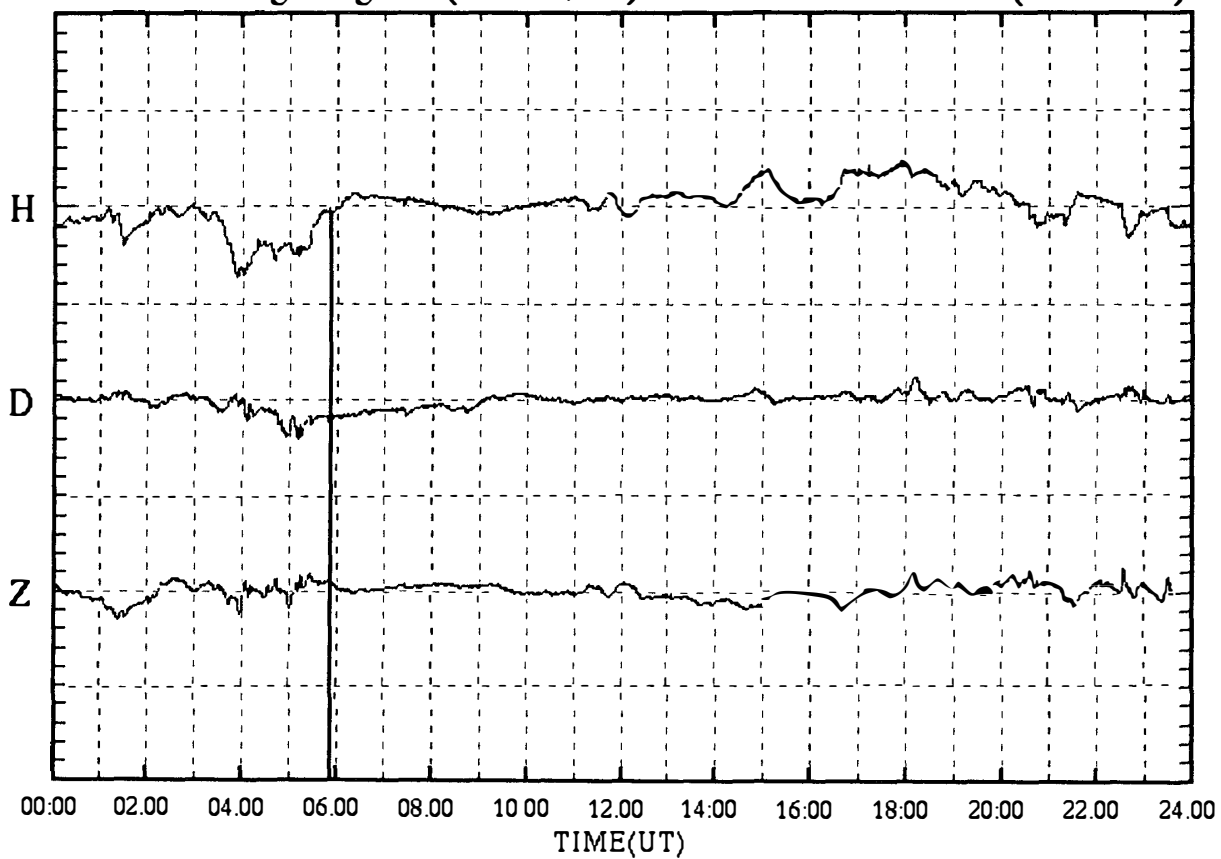

SYOWA magnetogram (100 nT/div)

09 Jan.1999 (DAY:009)

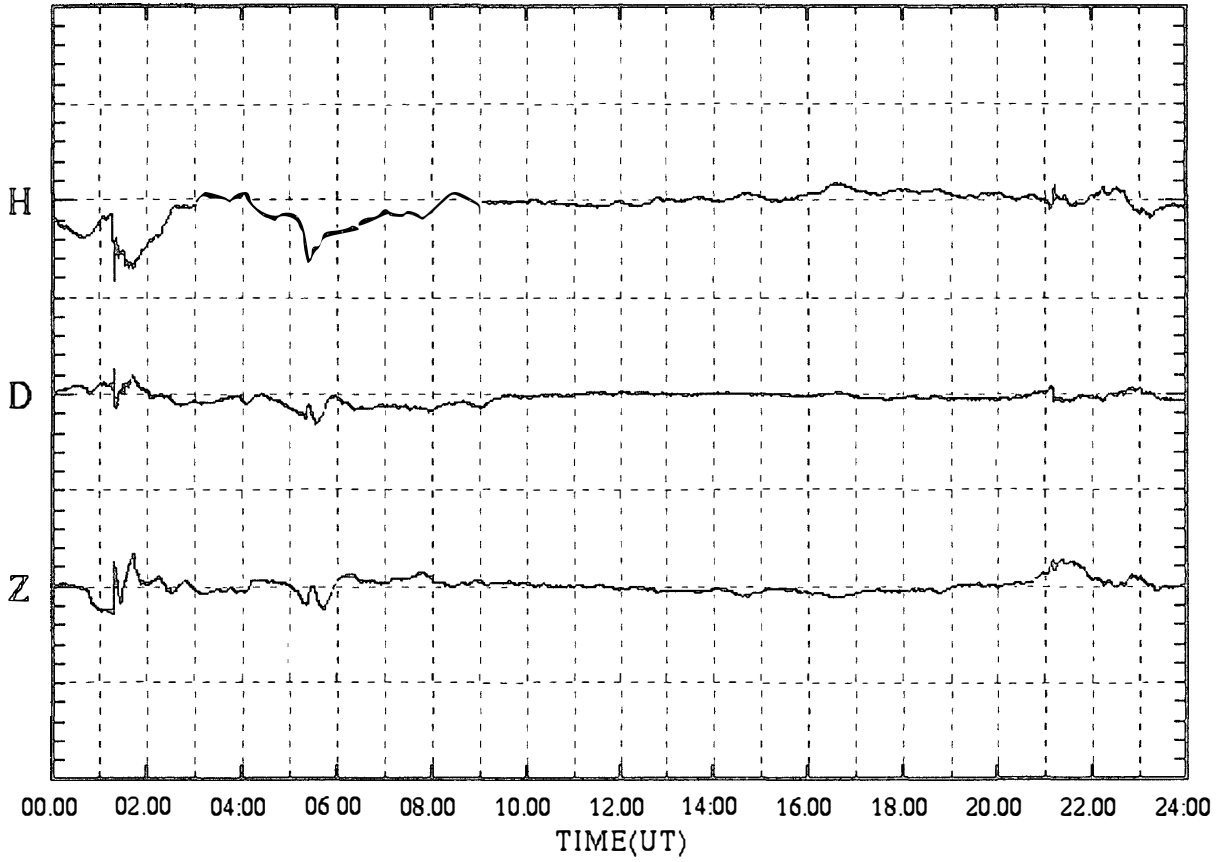

SYOWA magnetogram (100 nT/div)

10 Jan.1999 (DAY:010)

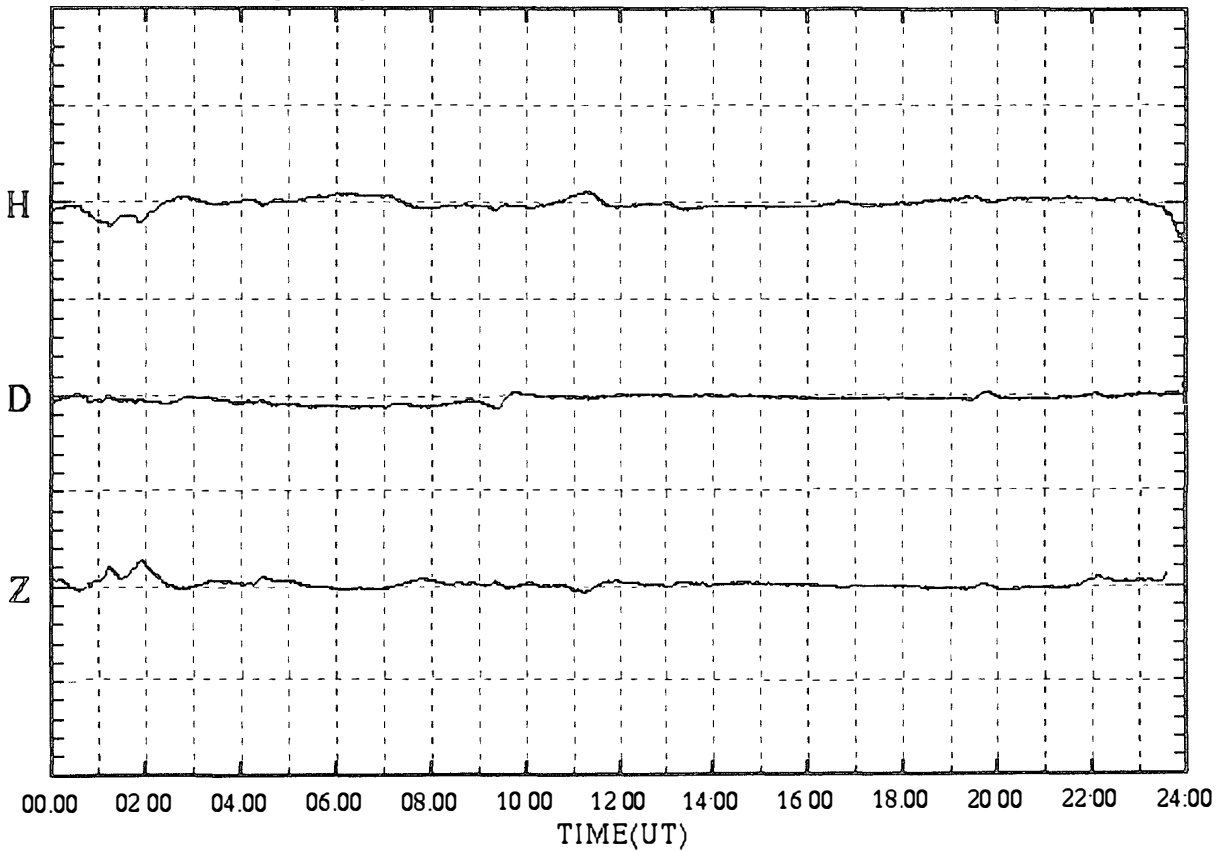

SYOWA magnetogram (100 nT/div)

11 Jan.1999 (DAY:011)

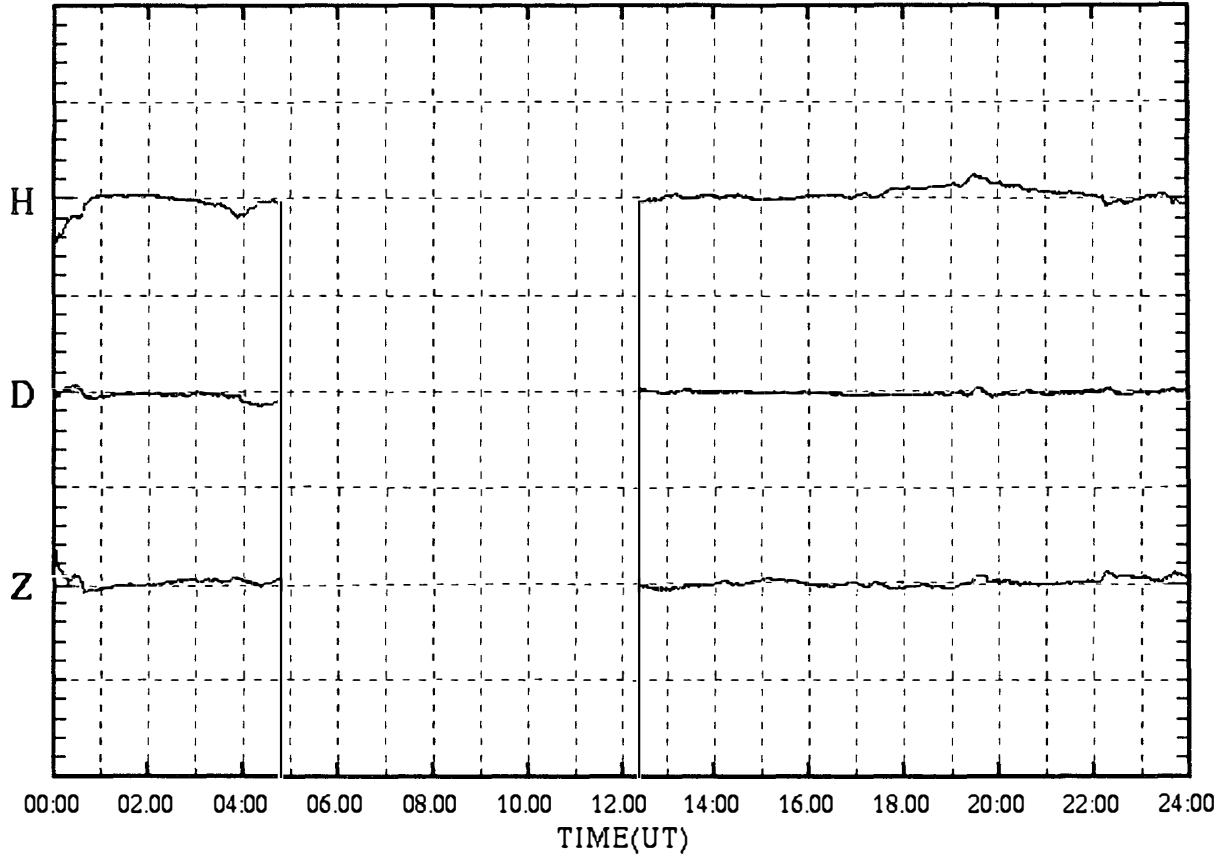

SYOWA magnetogram (100 nT/div)

12 Jan.1999 (DAY:012)

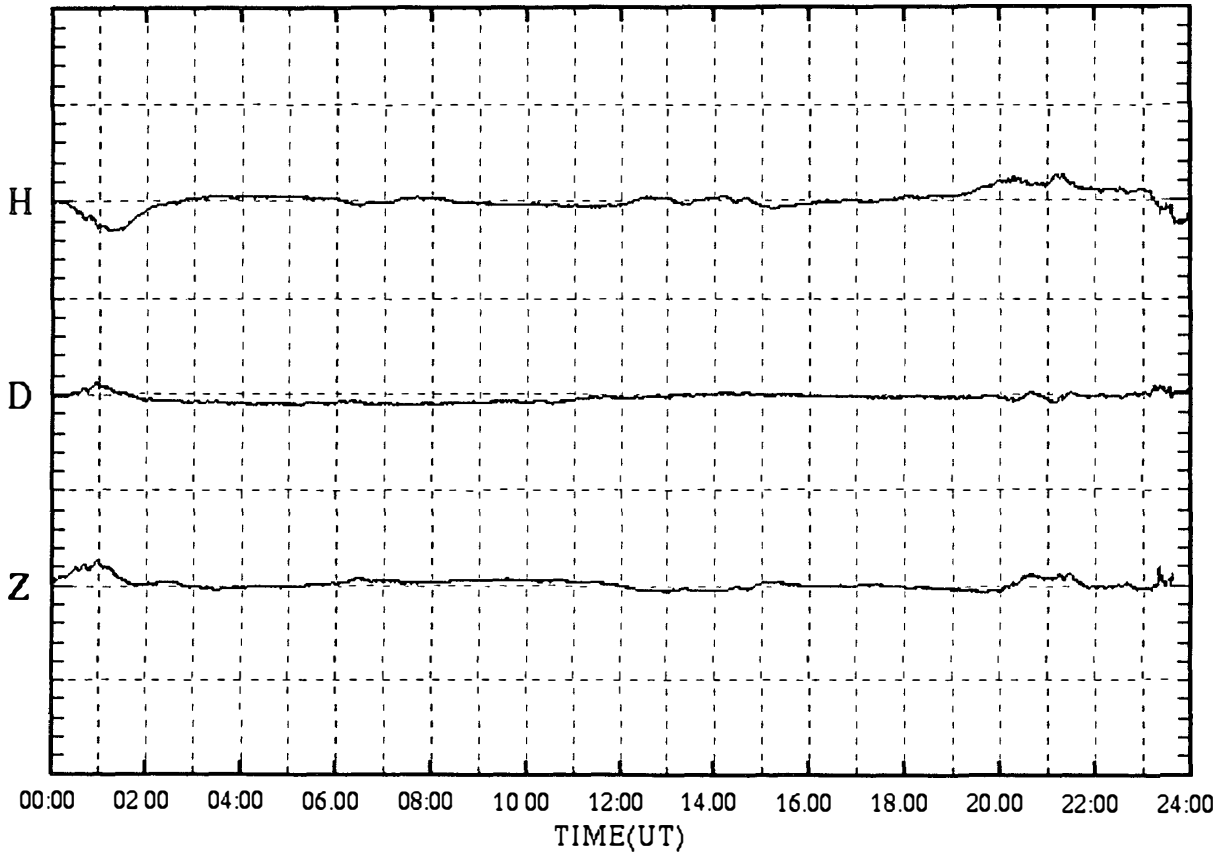

SYOWA magnetogram (100 nT/div)

13 Jan.1999 (DAY:013)

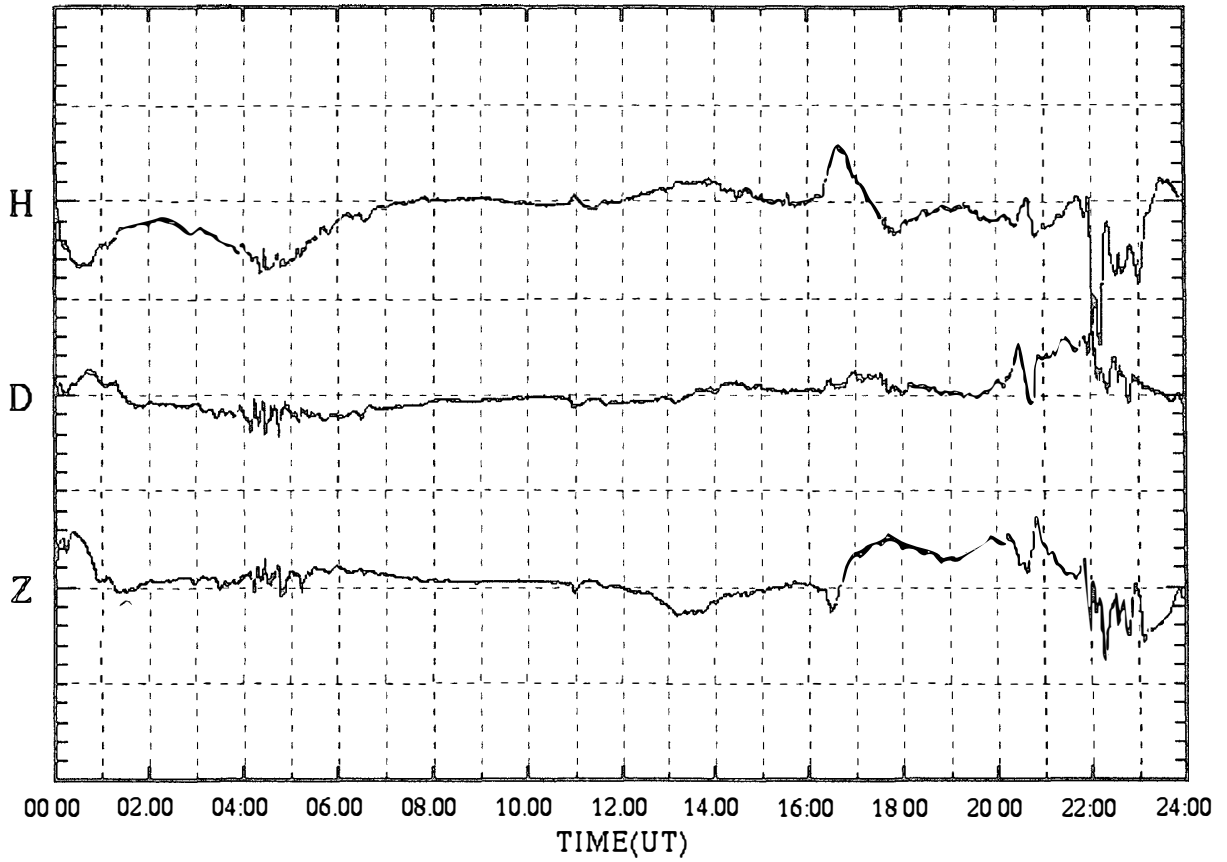

SYOWA magnetogram (100 nT/div)

14 Jan.1999 (DAY:014)

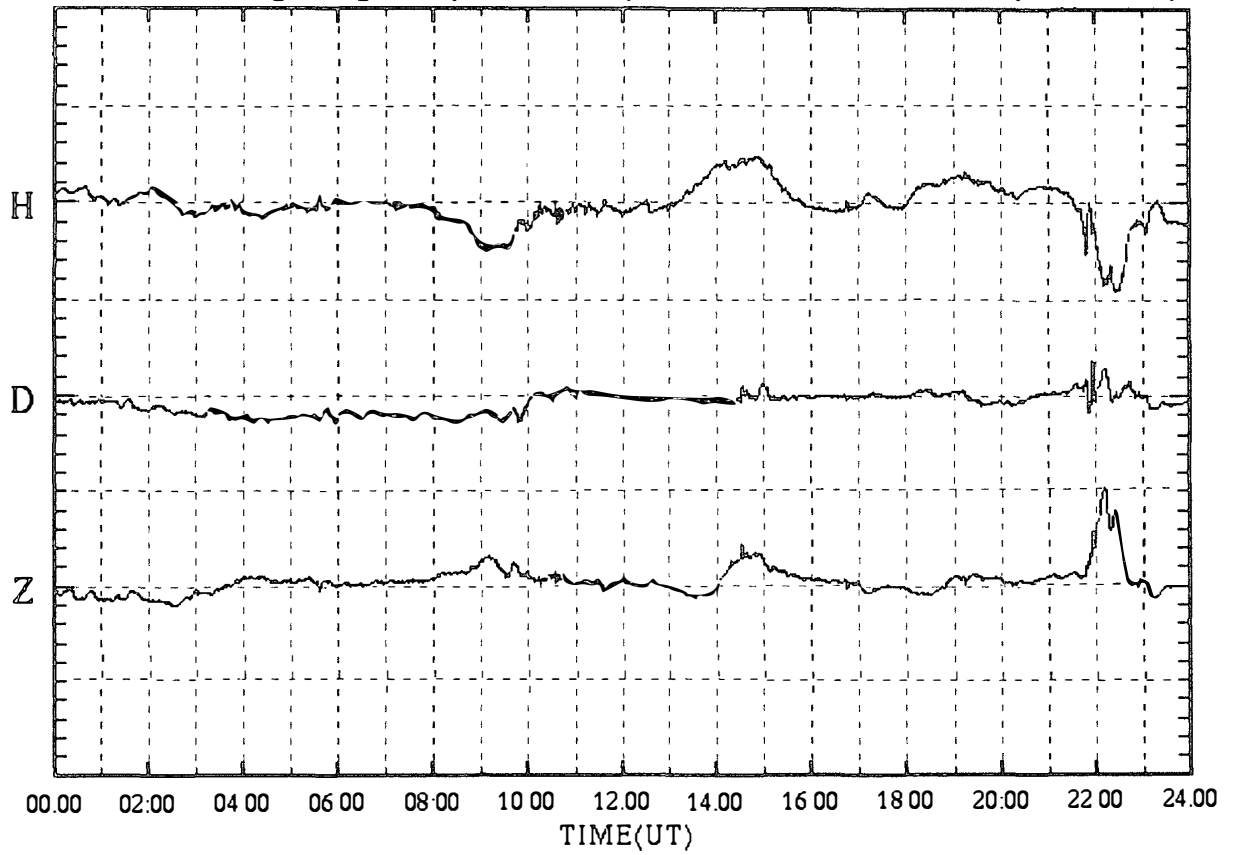

SYOWA magnetogram (100 nT/div)

15 Jan.1999 (DAY:015)

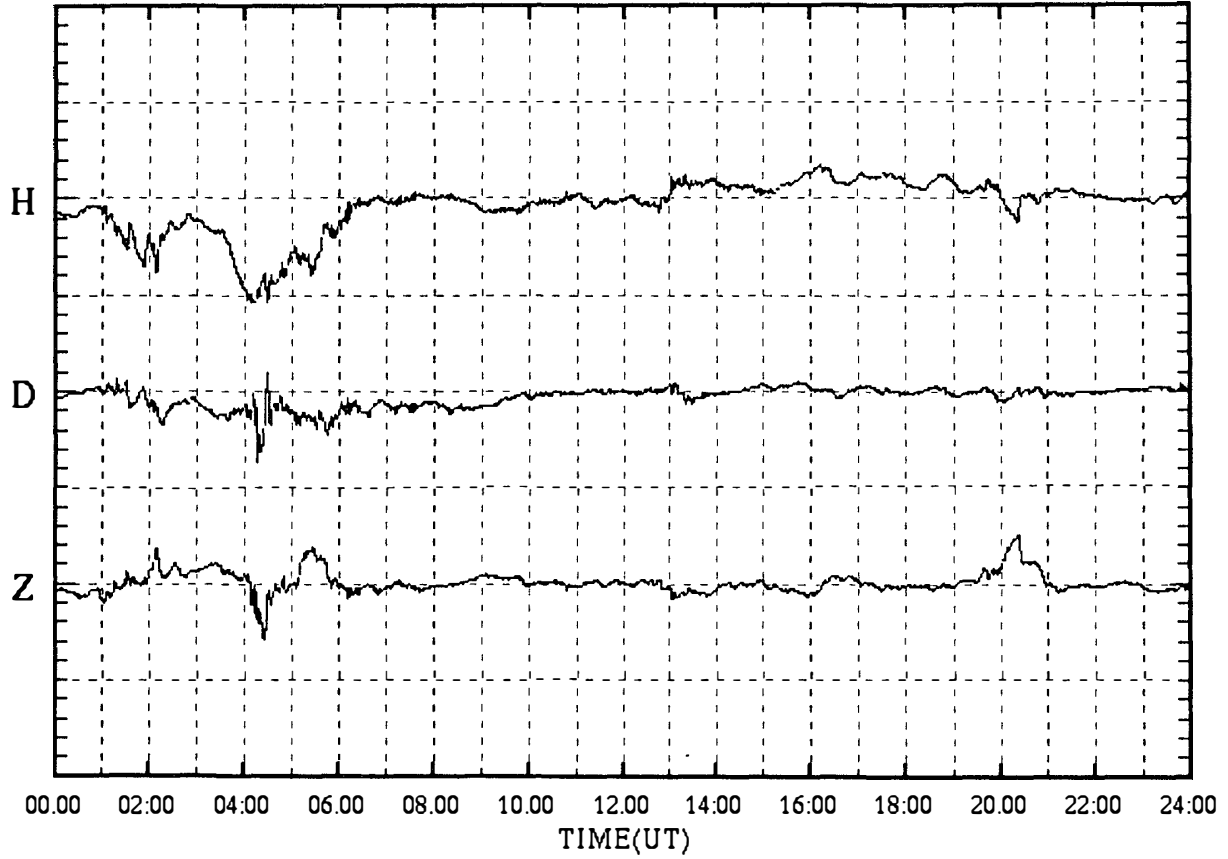

SYOWA magnetogram (100 nT/div)

16 Jan.1999 (DAY:016)

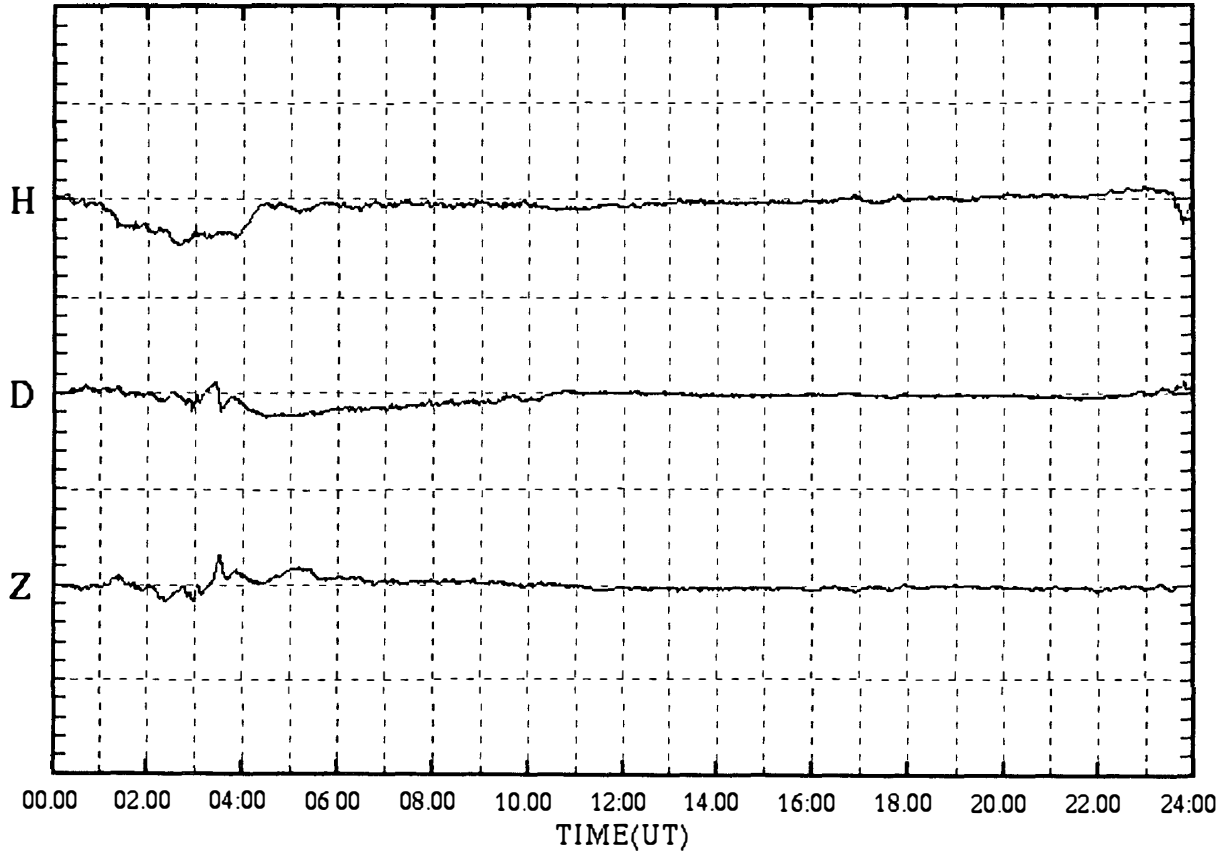



SYOWA magnetogram (100 nT/div)

17 Jan.1999 (DAY:017)

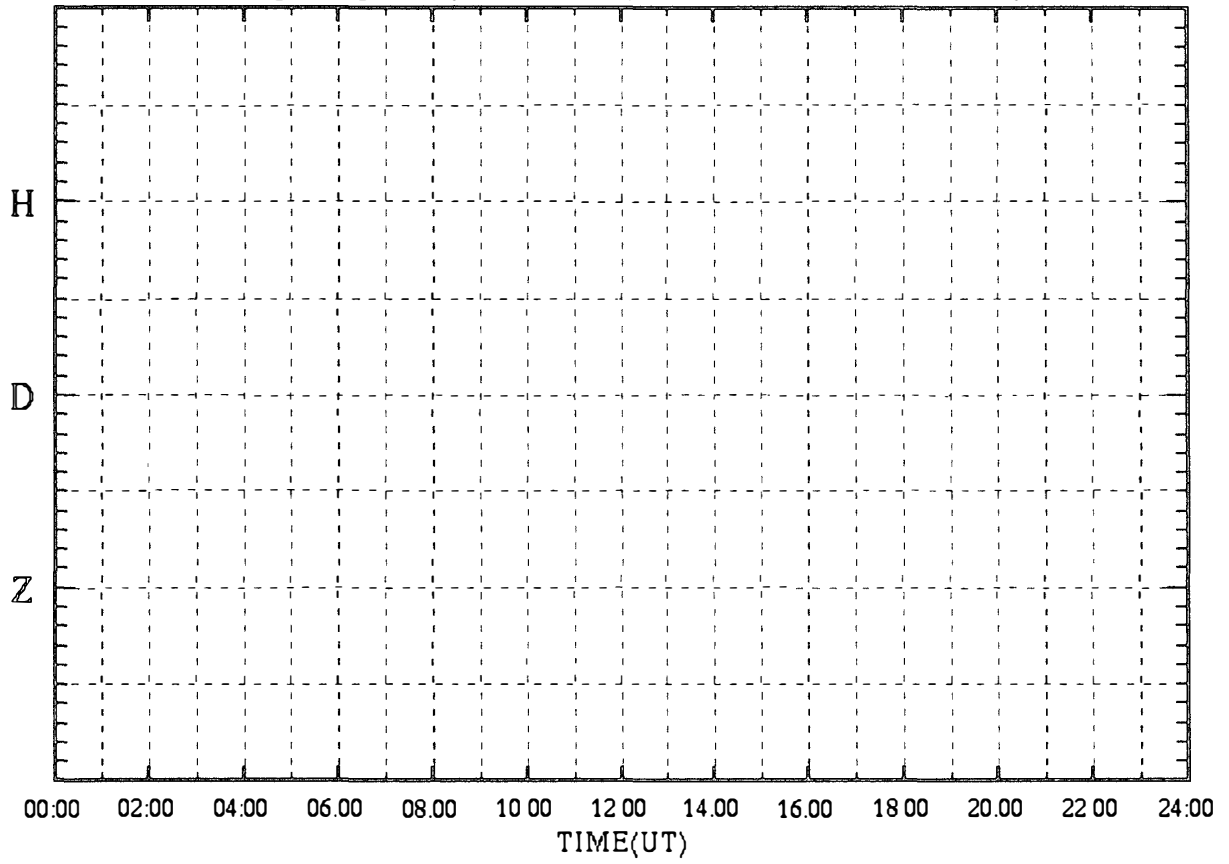

SYOWA magnetogram (100 nT/div)

18 Jan.1999 (DAY:018)

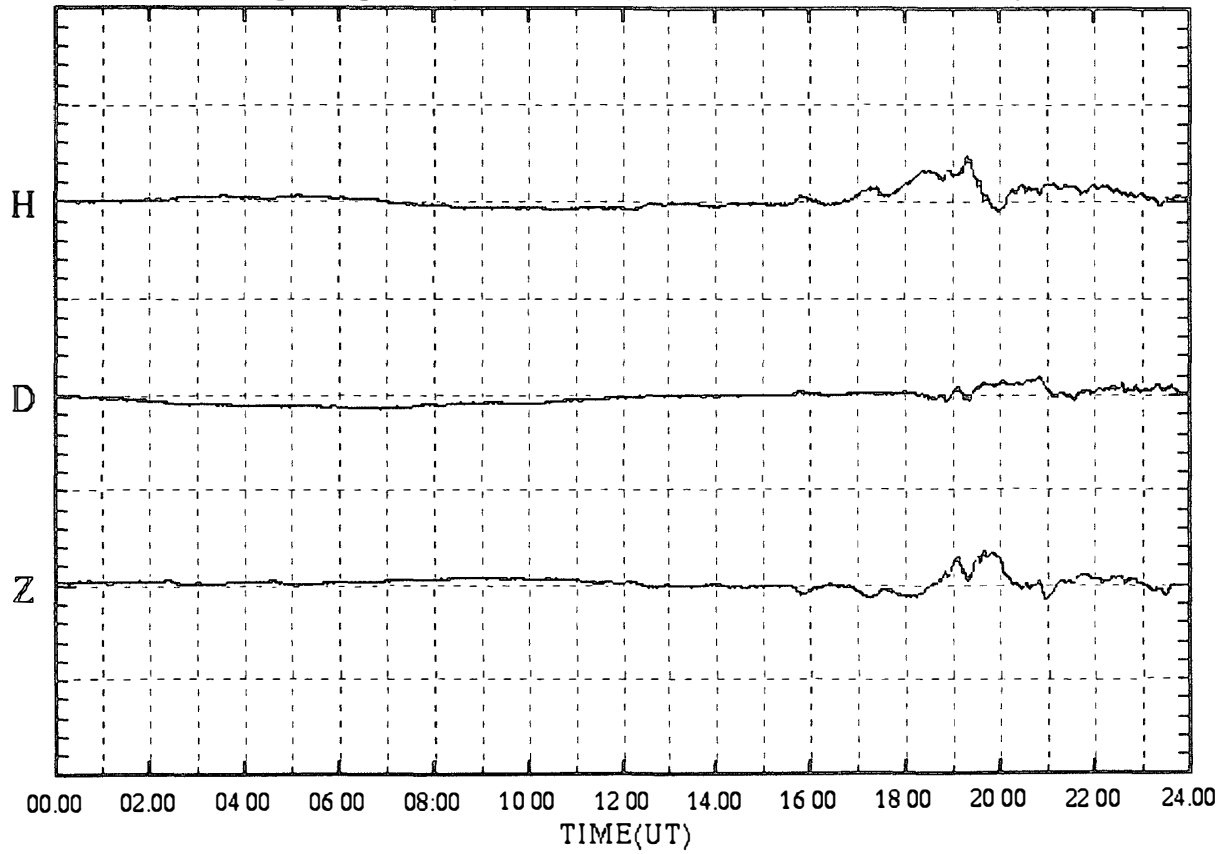

SYOWA magnetogram (100 nT/div)

19 Jan.1999 (DAY:019)

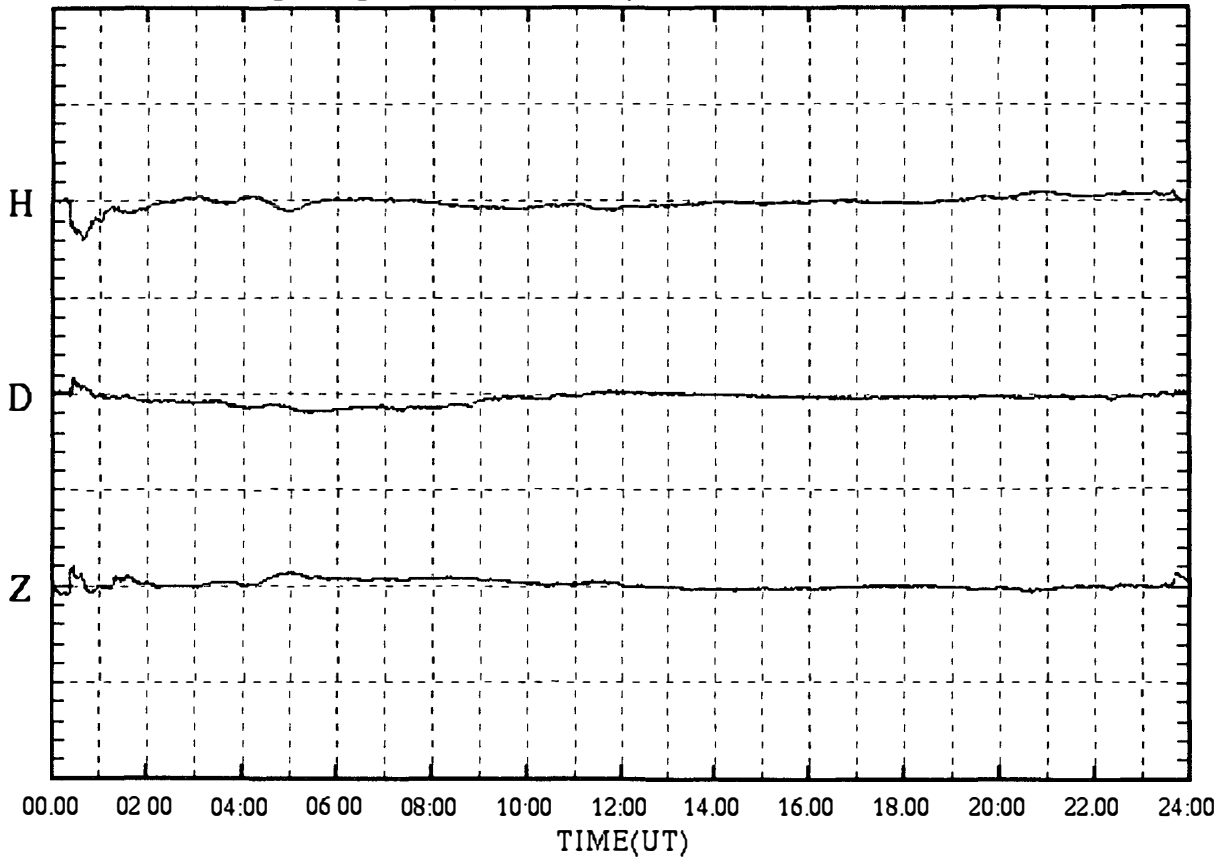

SYOWA magnetogram (100 nT/div)

20 Jan.1999 (DAY:020)

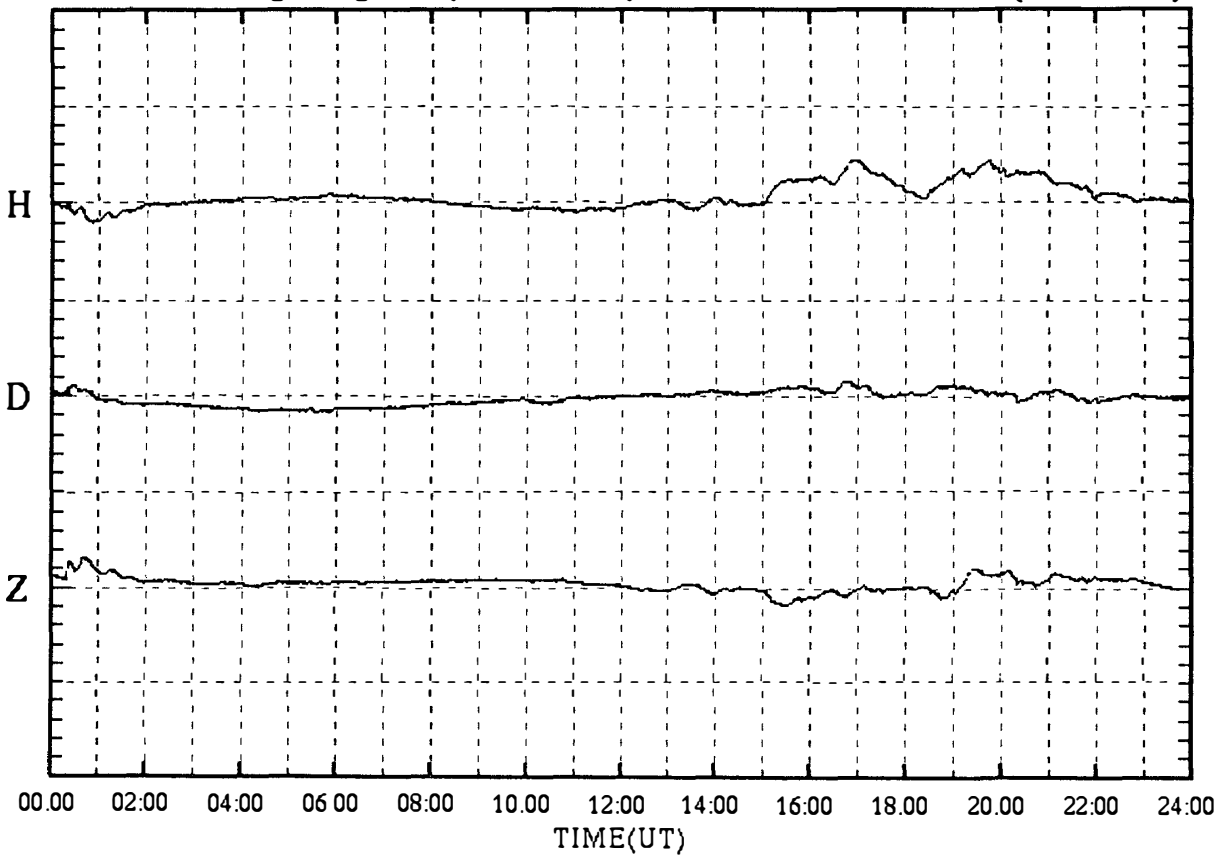

SYOWA magnetogram (100 nT/div)

21 Jan.1999 (DAY:021)

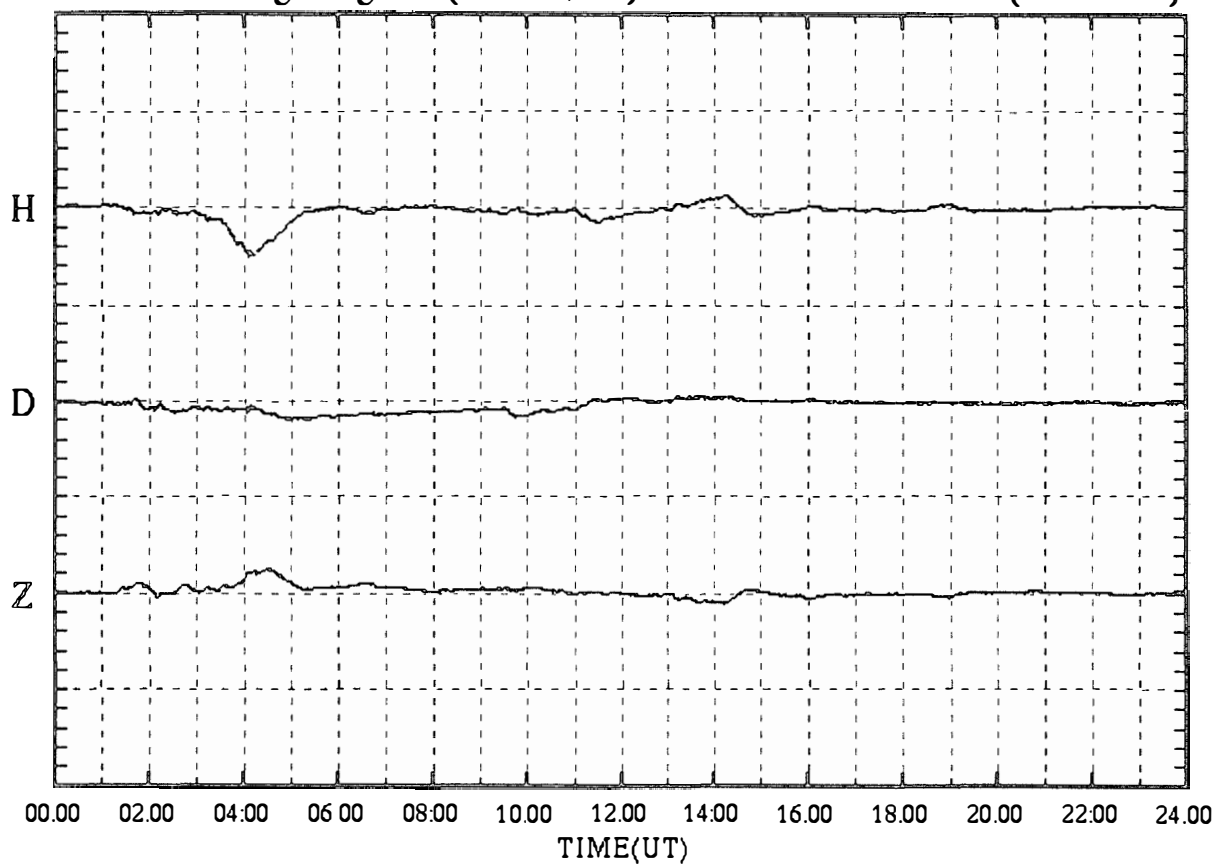

SYOWA magnetogram (100 nT/div)

22 Jan.1999 (DAY:022)

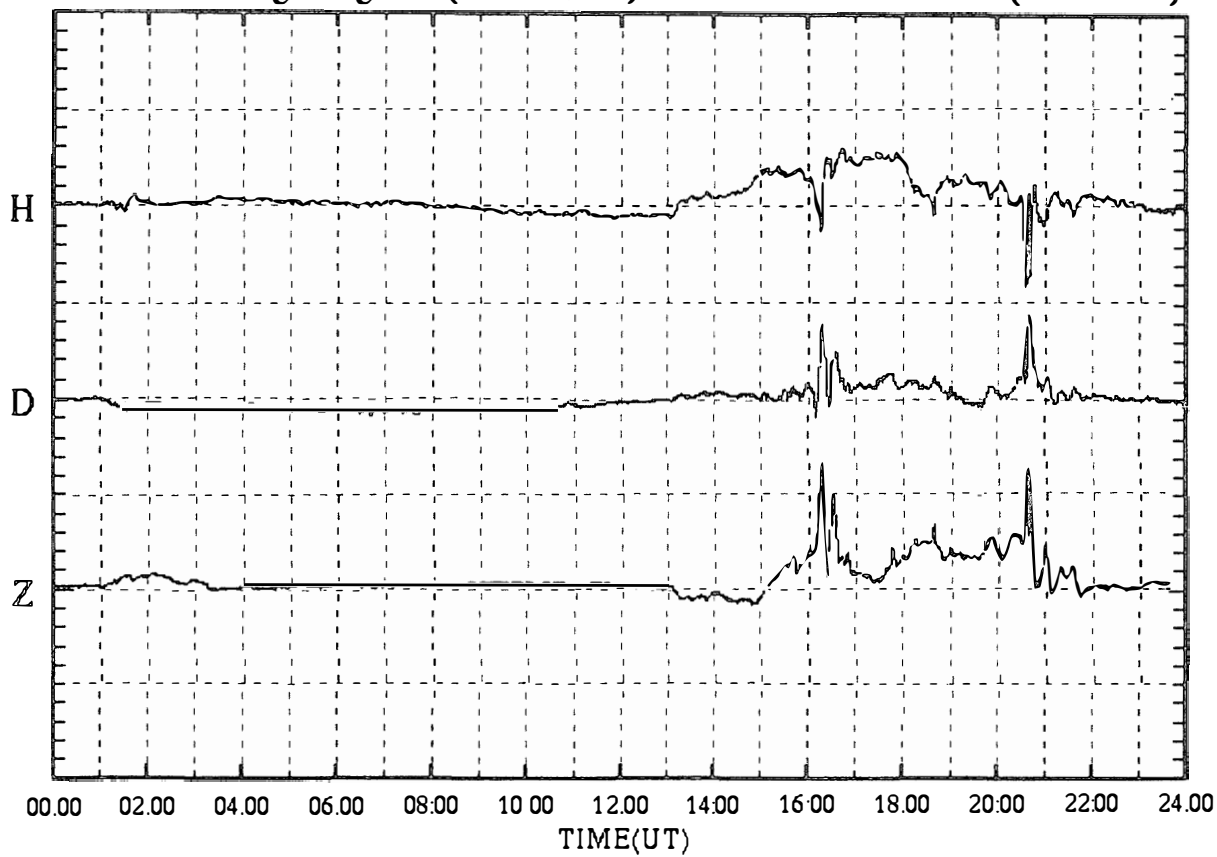

SYOWA magnetogram (100 nT/div)

23 Jan.1999 (DAY:023)

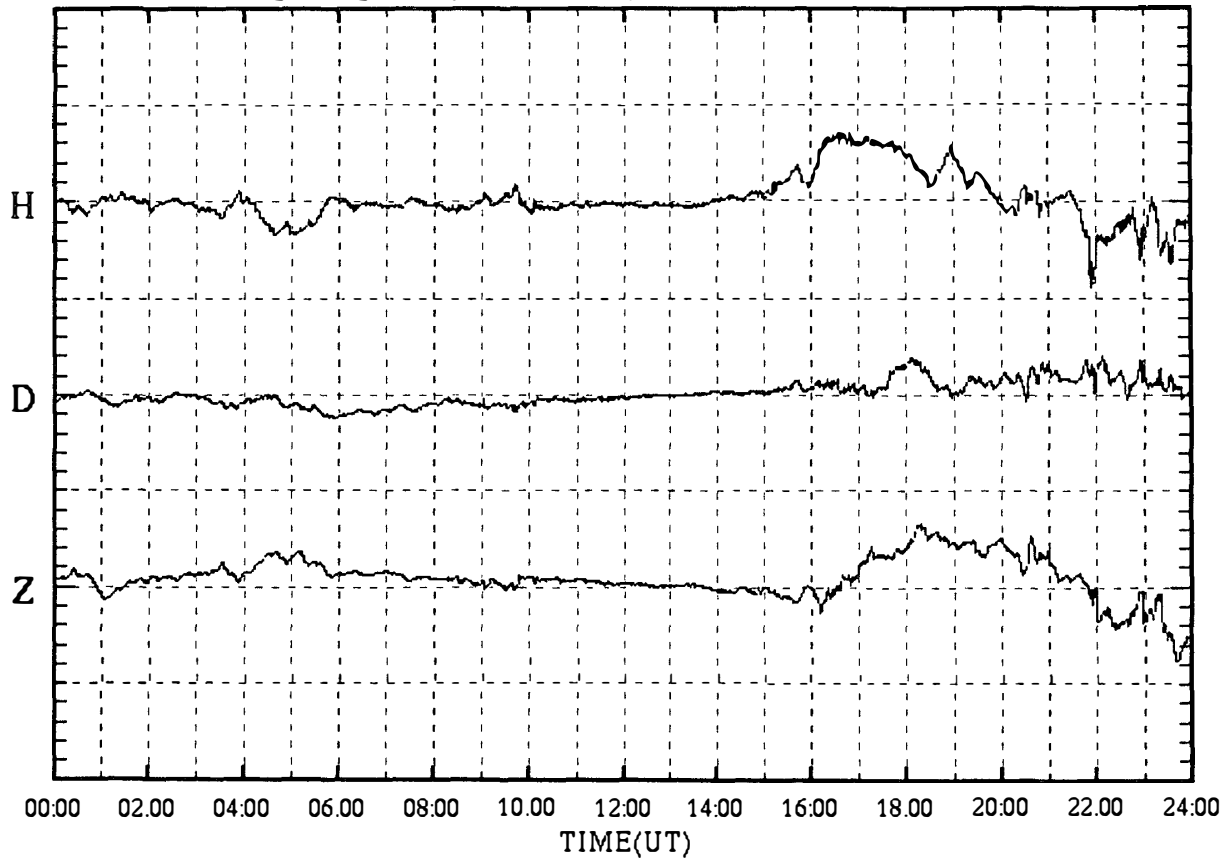

SYOWA magnetogram (100 nT/div)

24 Jan.1999 (DAY:024)

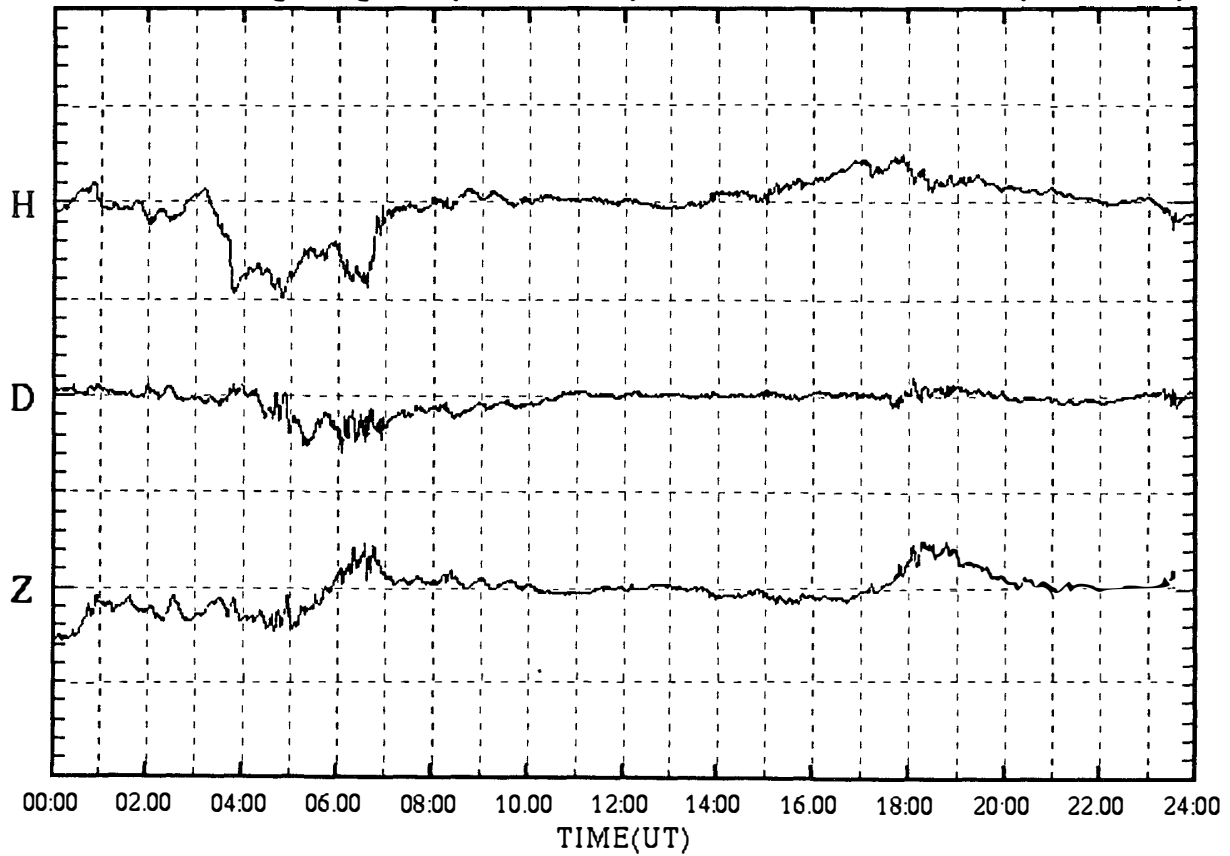

SYOWA magnetogram (100 nT/div)

25 Jan.1999 (DAY:025)

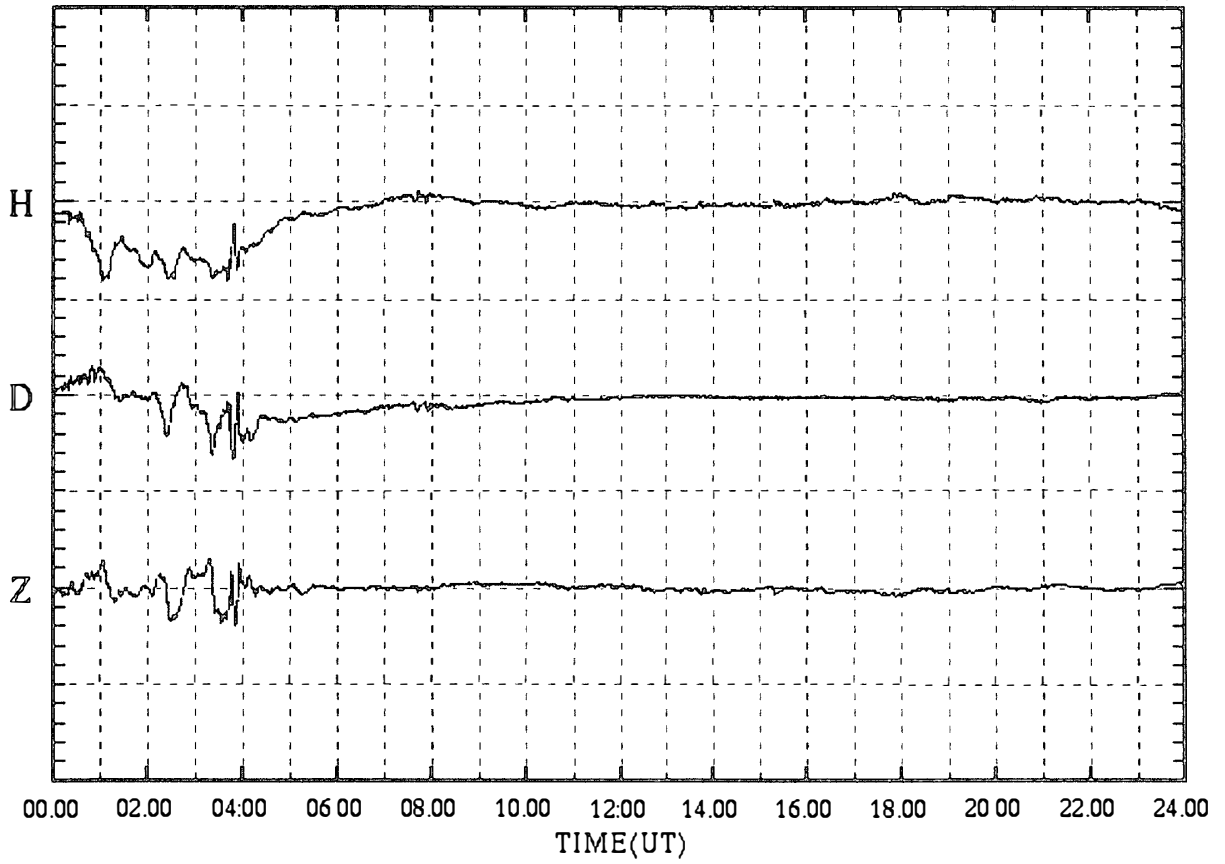

SYOWA magnetogram (100 nT/div)

26 Jan.1999 (DAY:026)

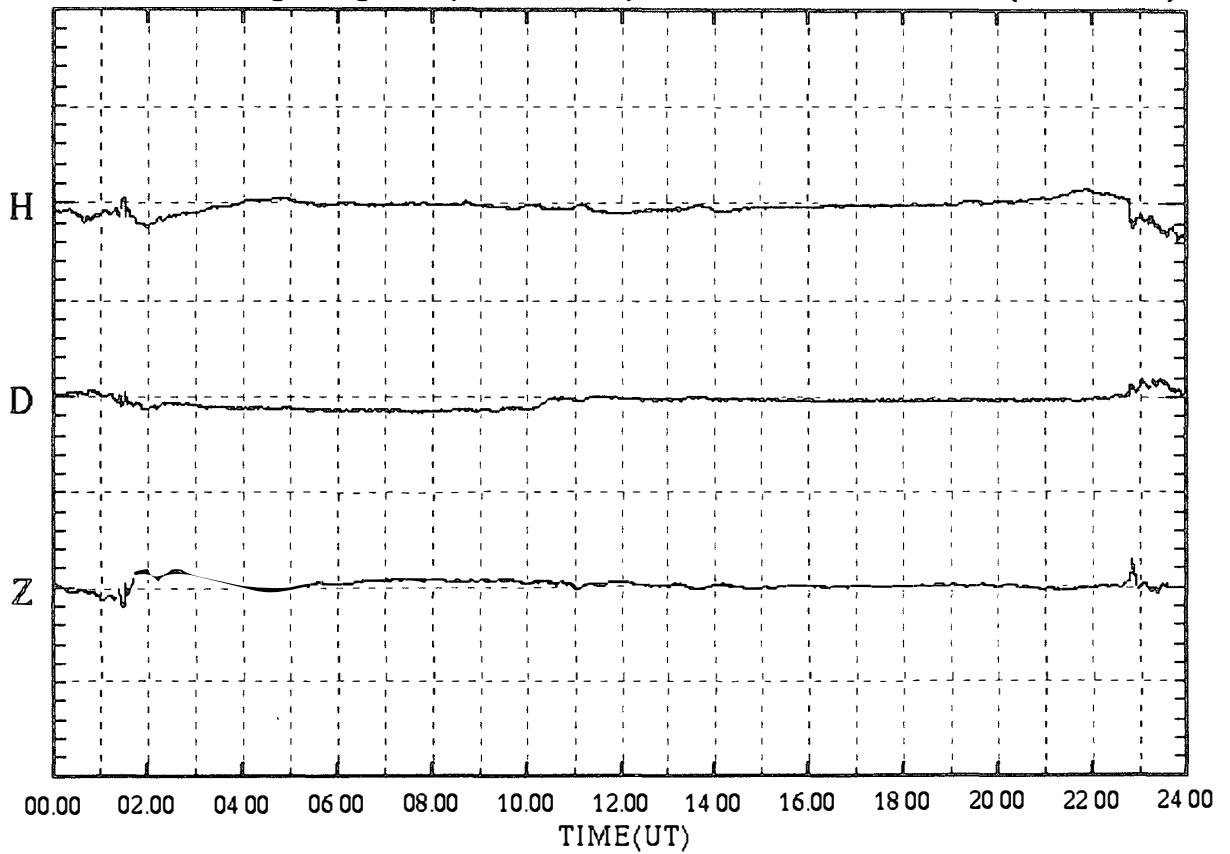

SYOWA magnetogram (100 nT/div)

27 Jan.1999 (DAY:027)

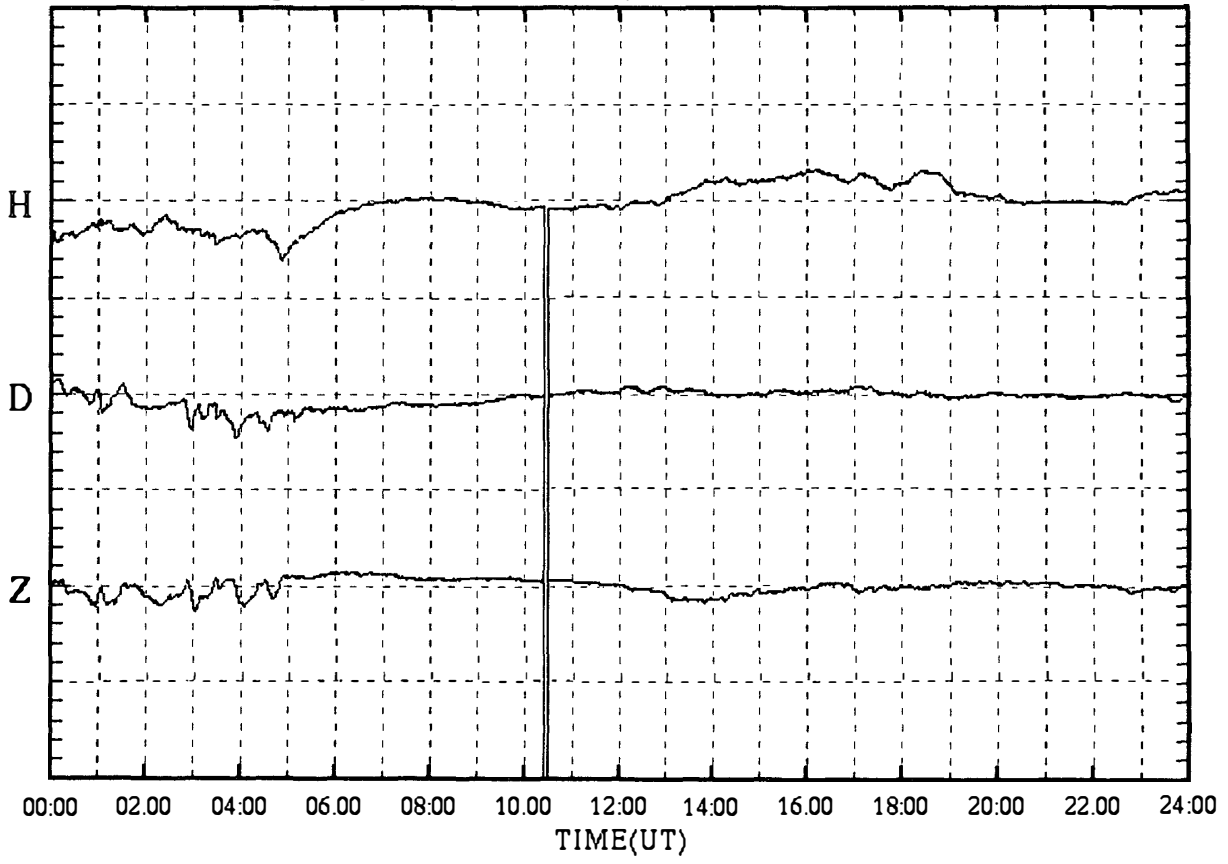

SYOWA magnetogram (100 nT/div)

28 Jan.1999 (DAY:028)

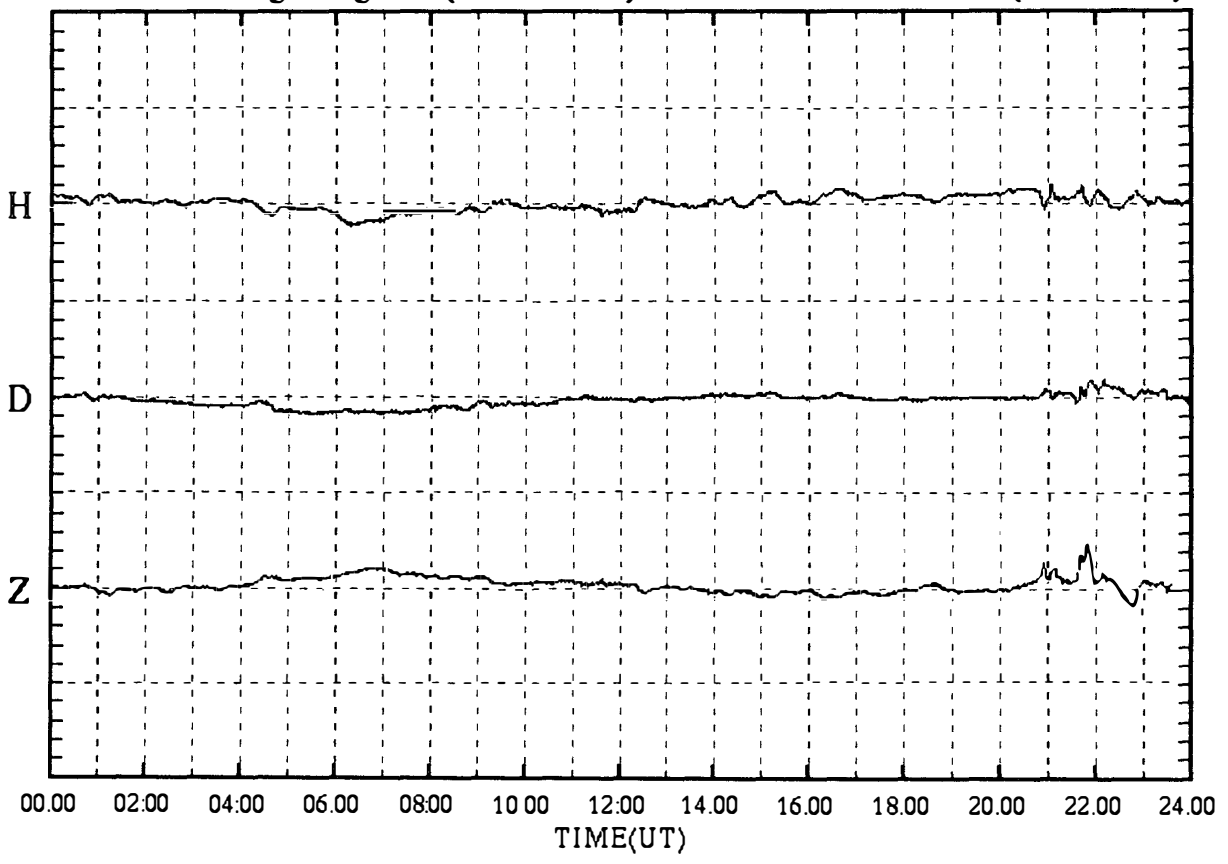

SYOWA magnetogram (100 nT/div)

29 Jan.1999 (DAY:029)

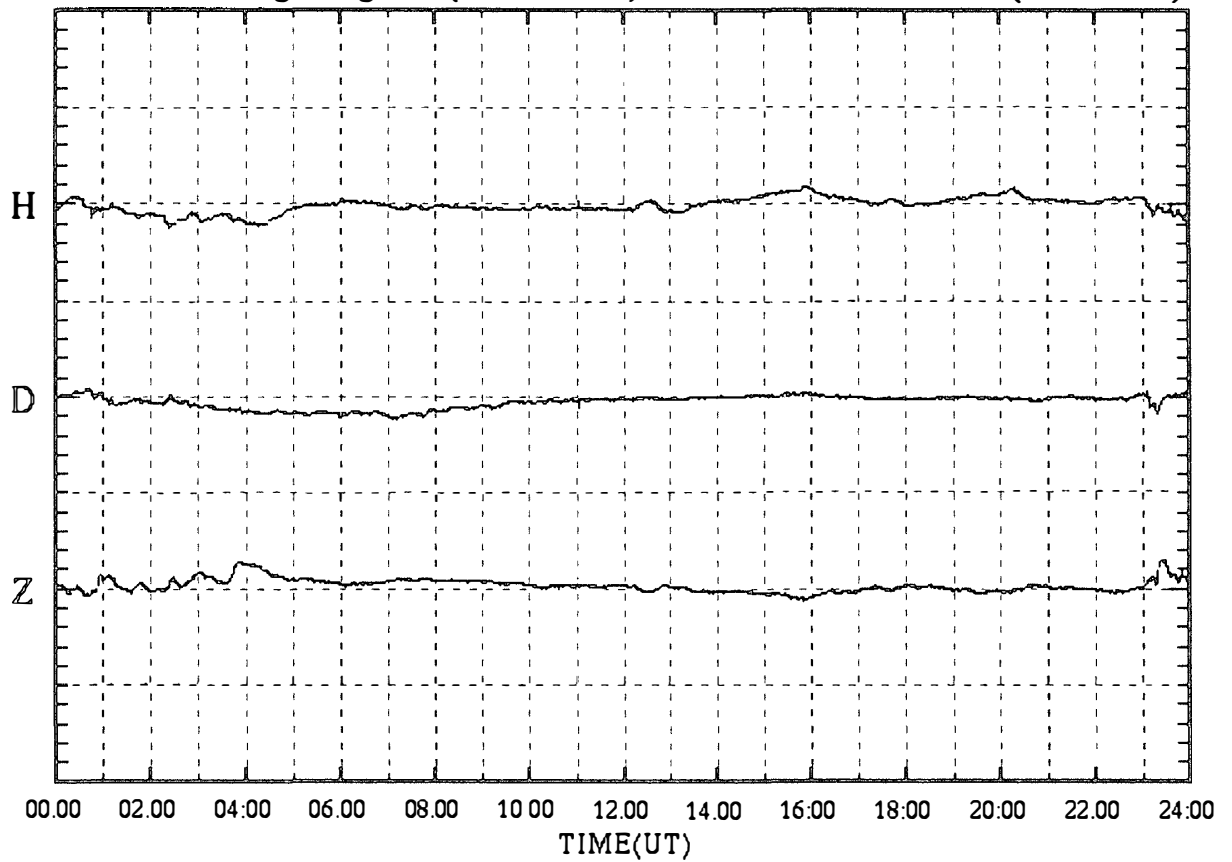

SYOWA magnetogram (100 nT/div)

30 Jan.1999 (DAY:030)

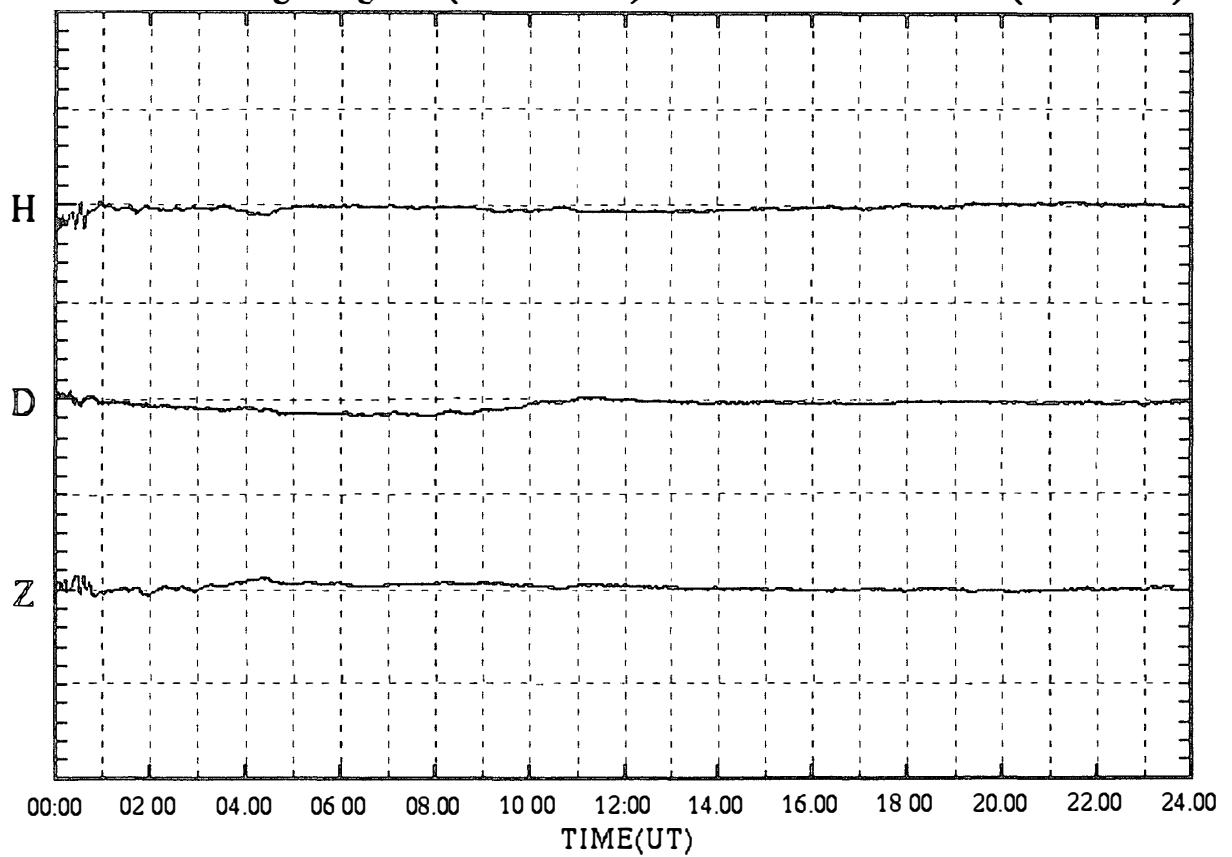

SYOWA magnetogram (100 nT/div)

31 Jan.1999 (DAY:031)

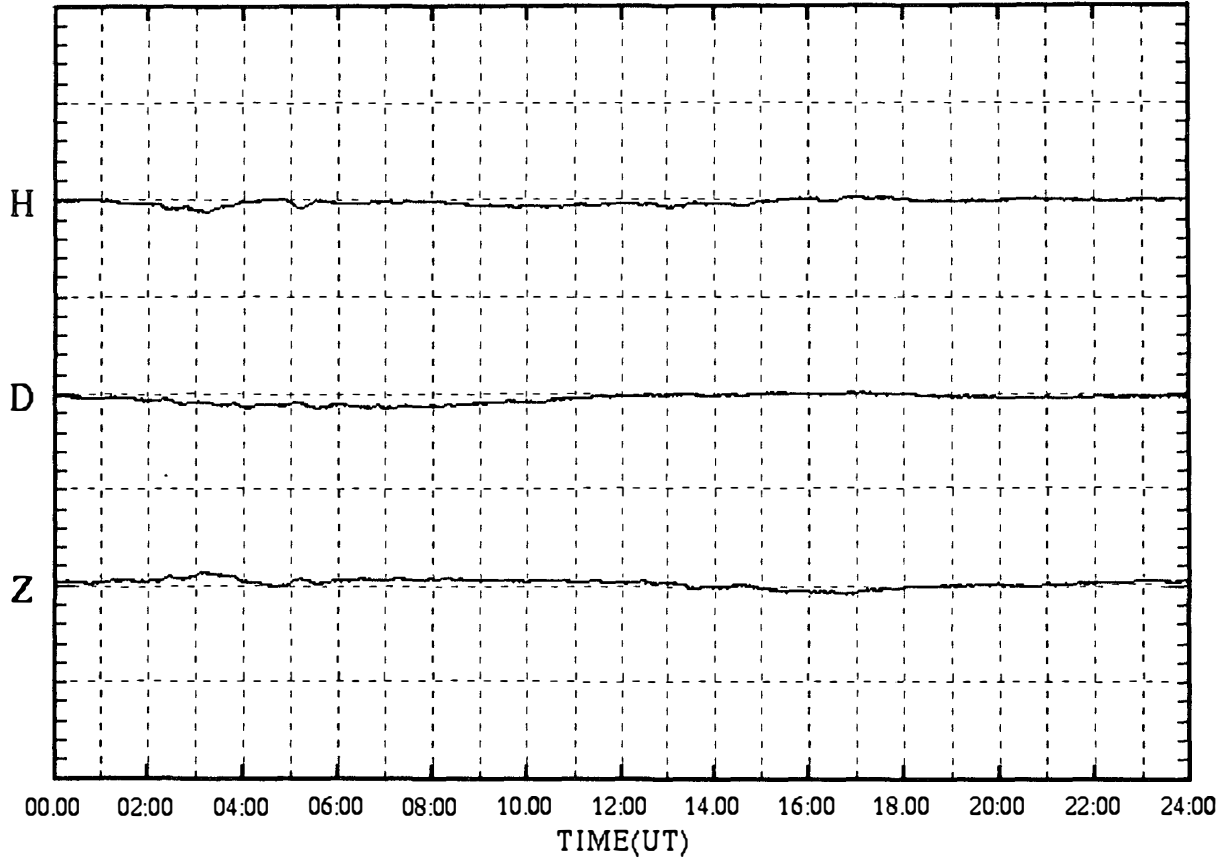

SYOWA magnetogram (100 nT/div)

01 Feb.1999 (DAY:032)

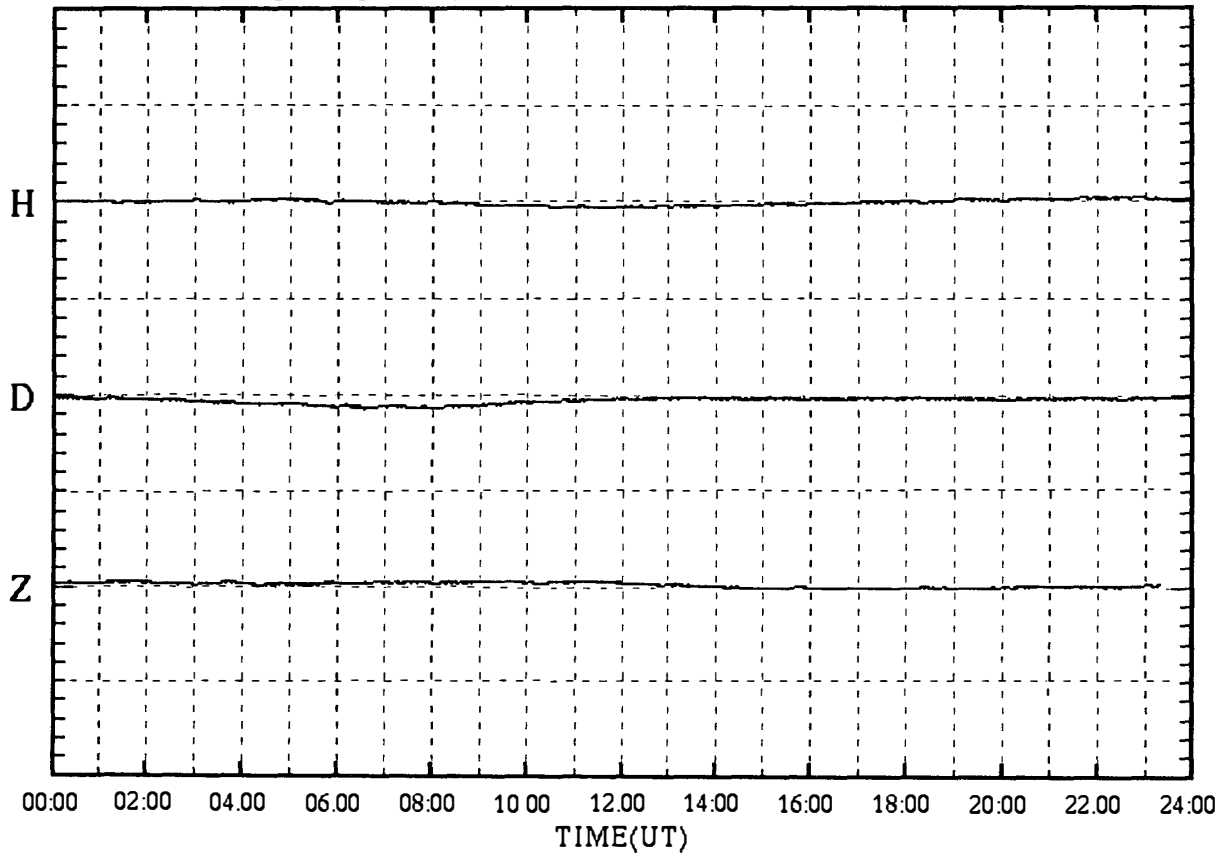



SYOWA magnetogram (100 nT/div)

02 Feb.1999 (DAY:033)

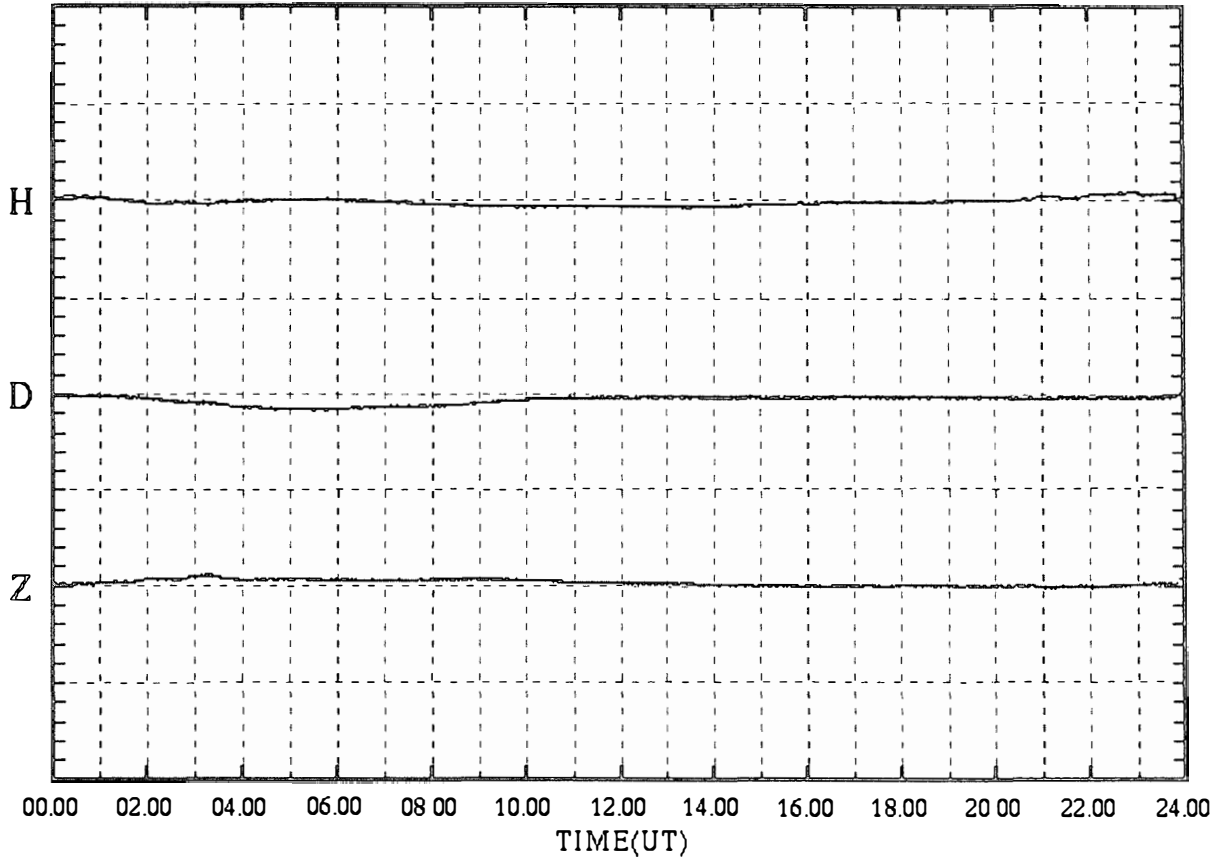

SYOWA magnetogram (100 nT/div)

03 Feb.1999 (DAY:034)

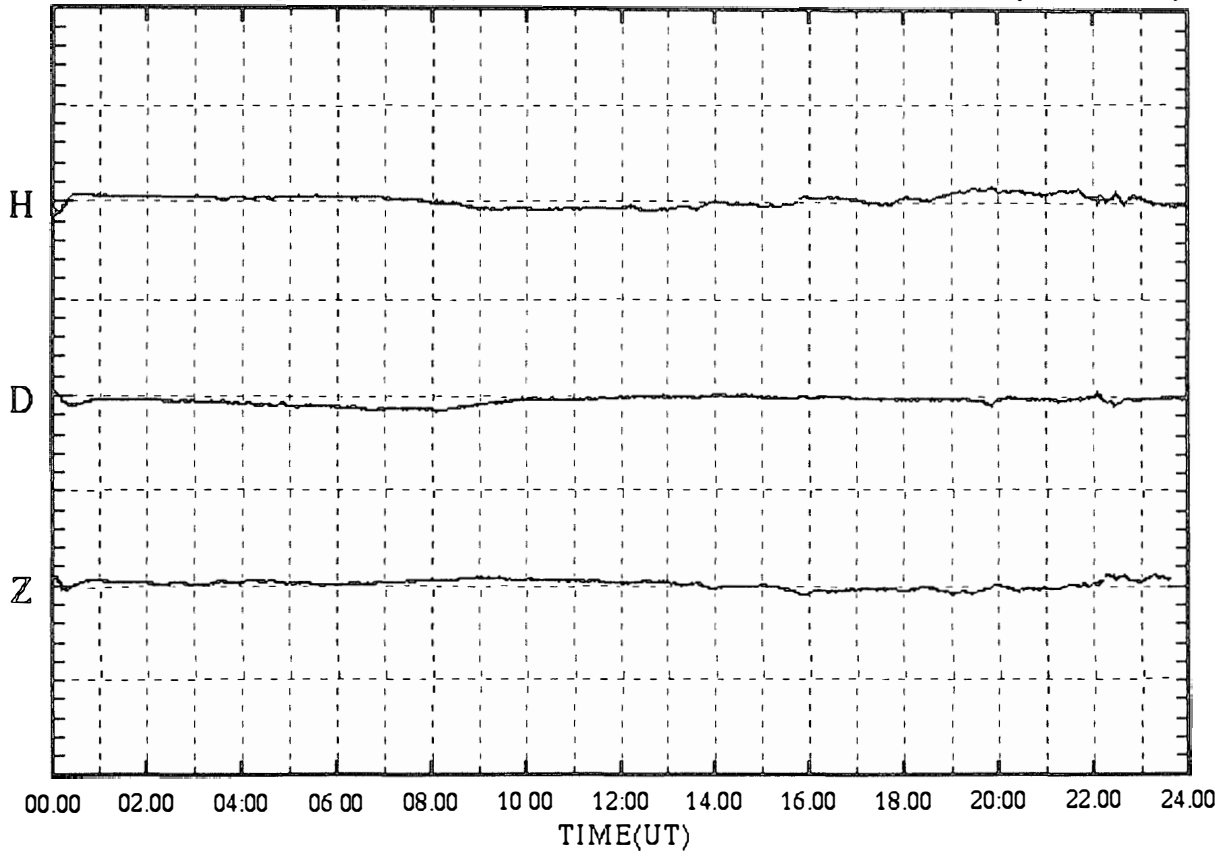

SYOWA magnetogram (100 nT/div)

04 Feb.1999 (DAY:035)

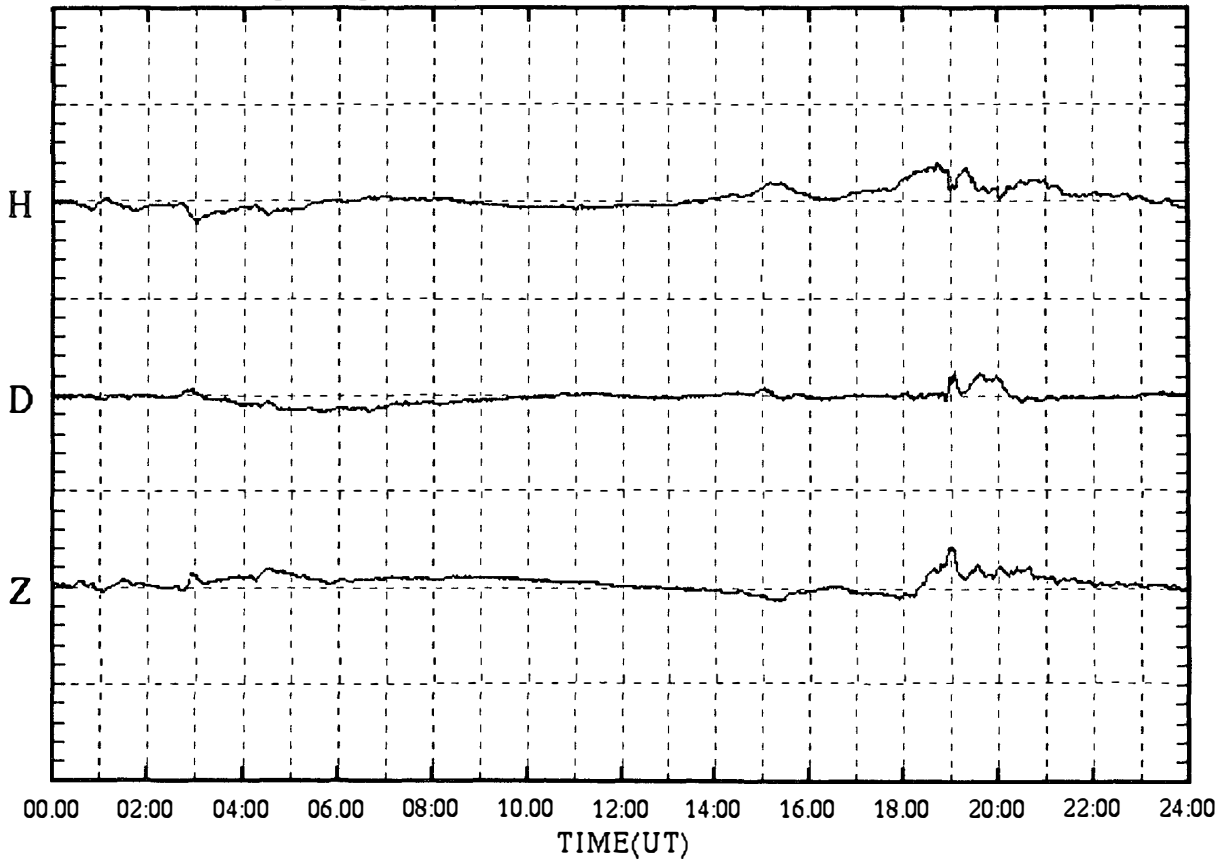

SYOWA magnetogram (100 nT/div)

05 Feb.1999 (DAY:036)

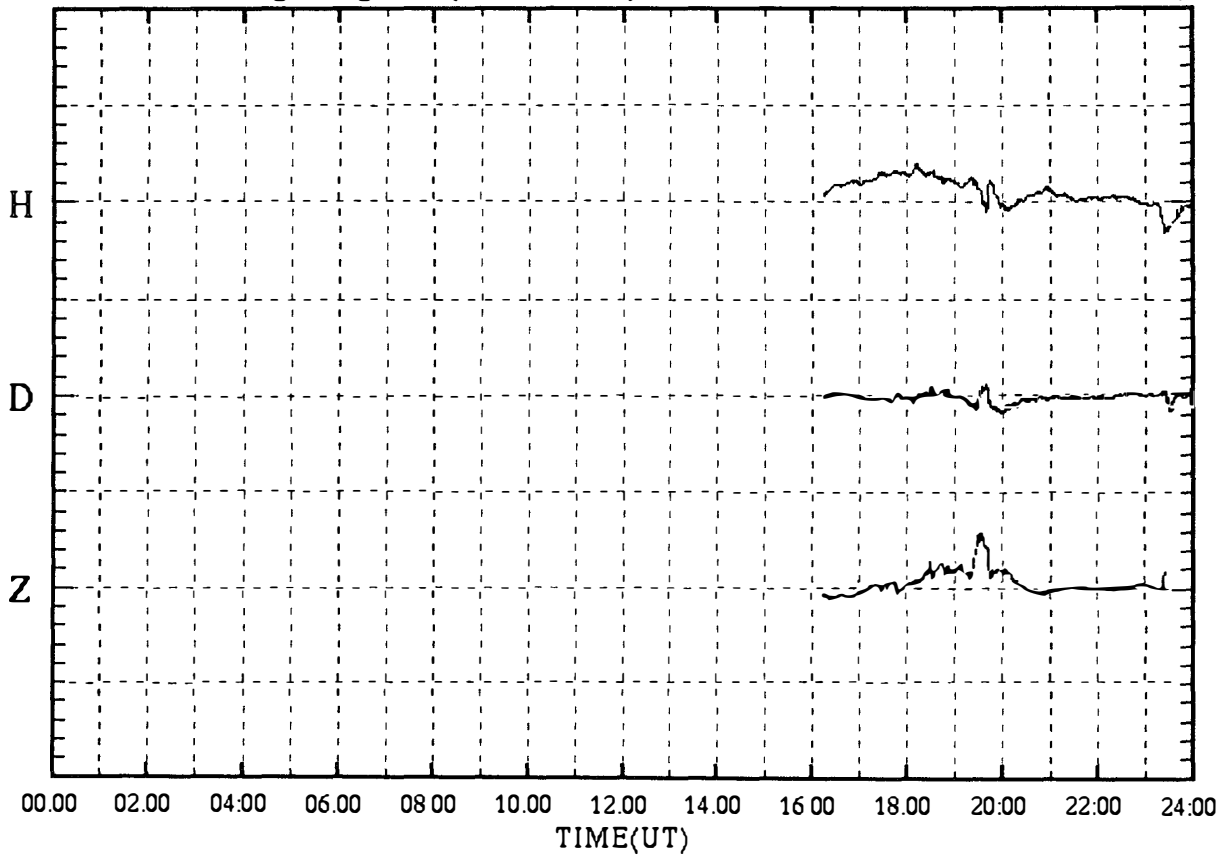

SYOWA magnetogram (100 nT/div)

06 Feb.1999 (DAY:037)

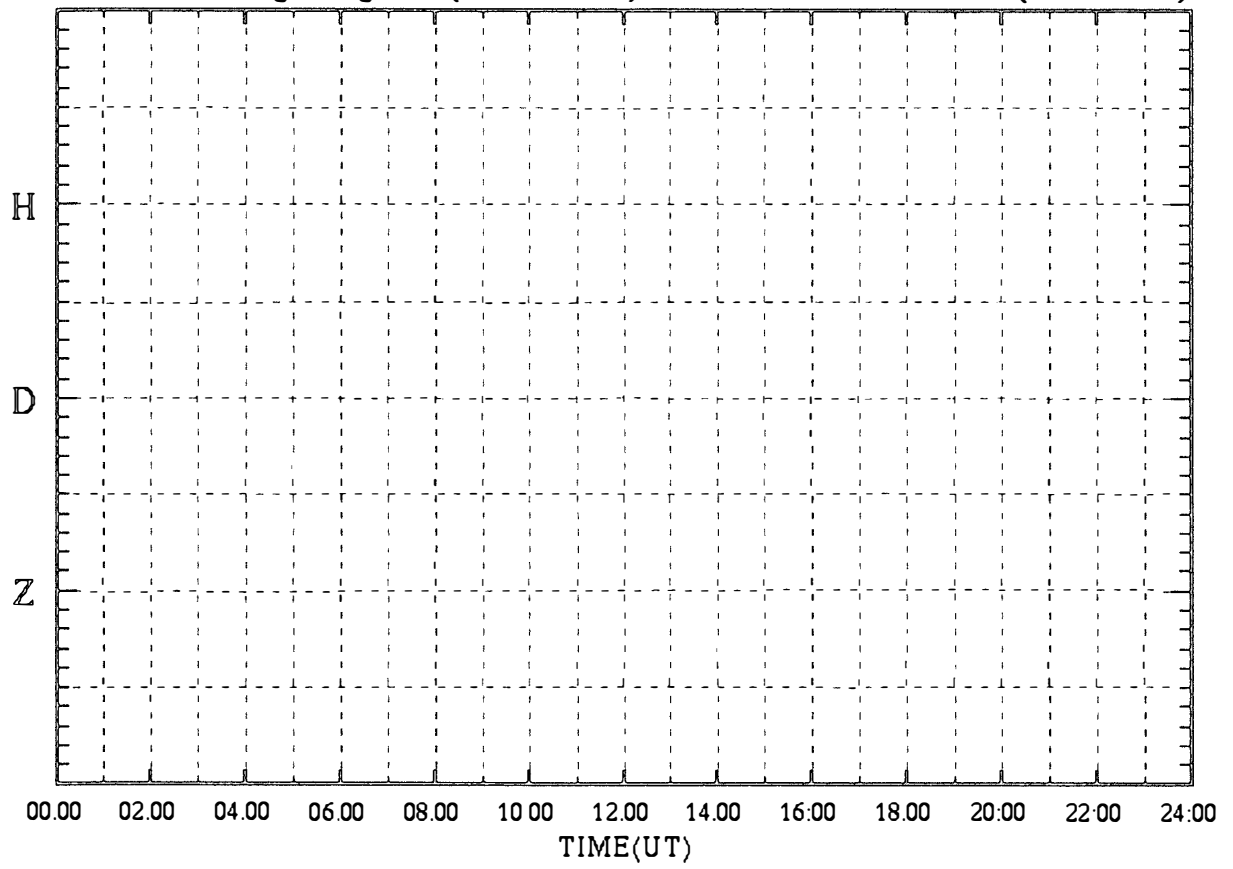

SYOWA magnetogram (100 nT/div)

07 Feb.1999 (DAY:038)

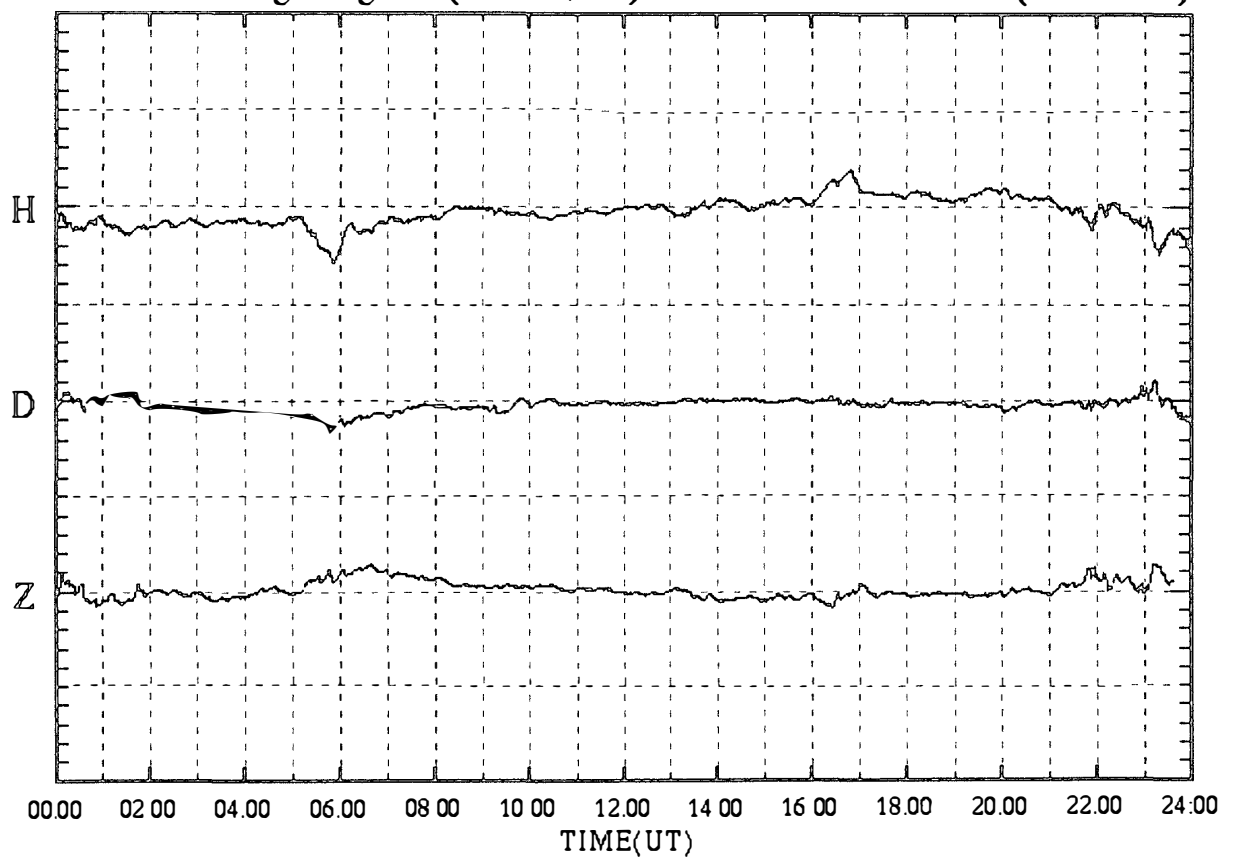

SYOWA magnetogram (100 nT/div)

08 Feb.1999 (DAY:039)

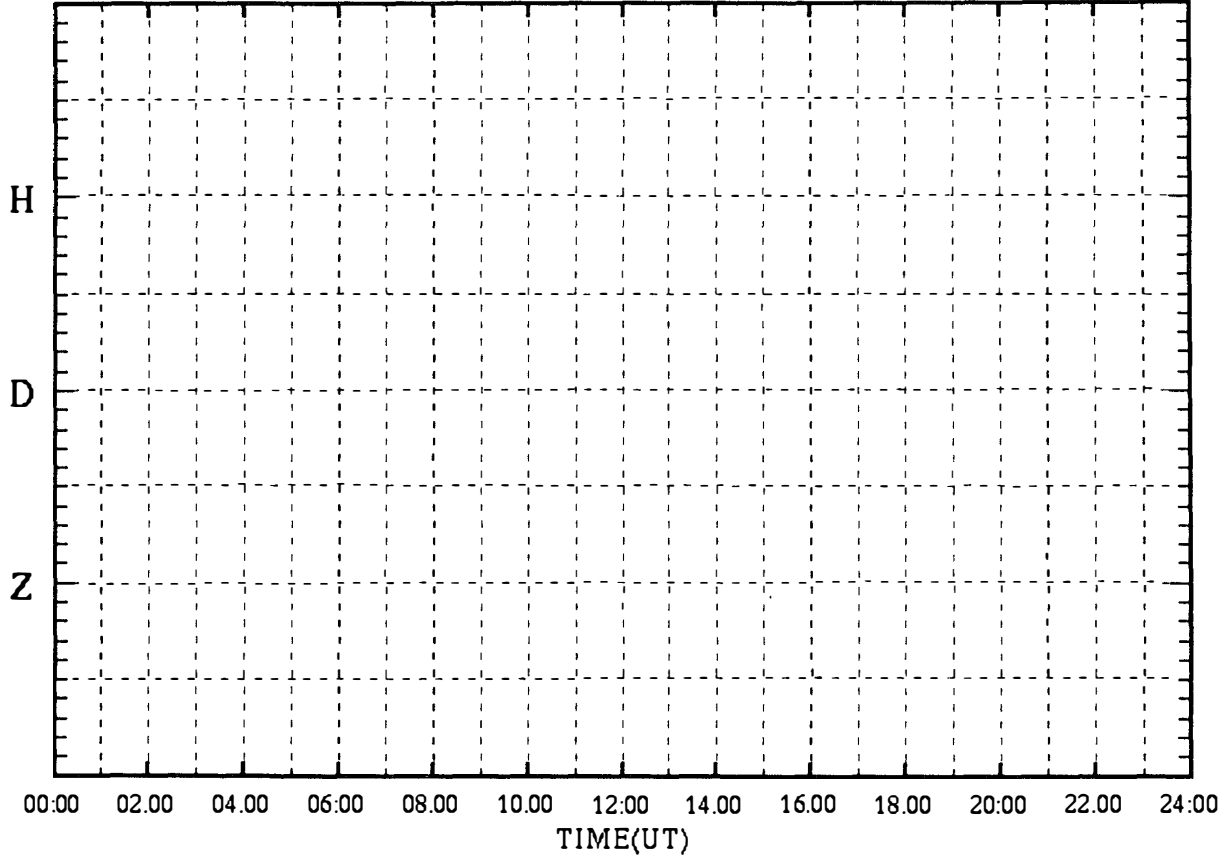

SYOWA magnetogram (100 nT/div)

09 Feb.1999 (DAY:040)

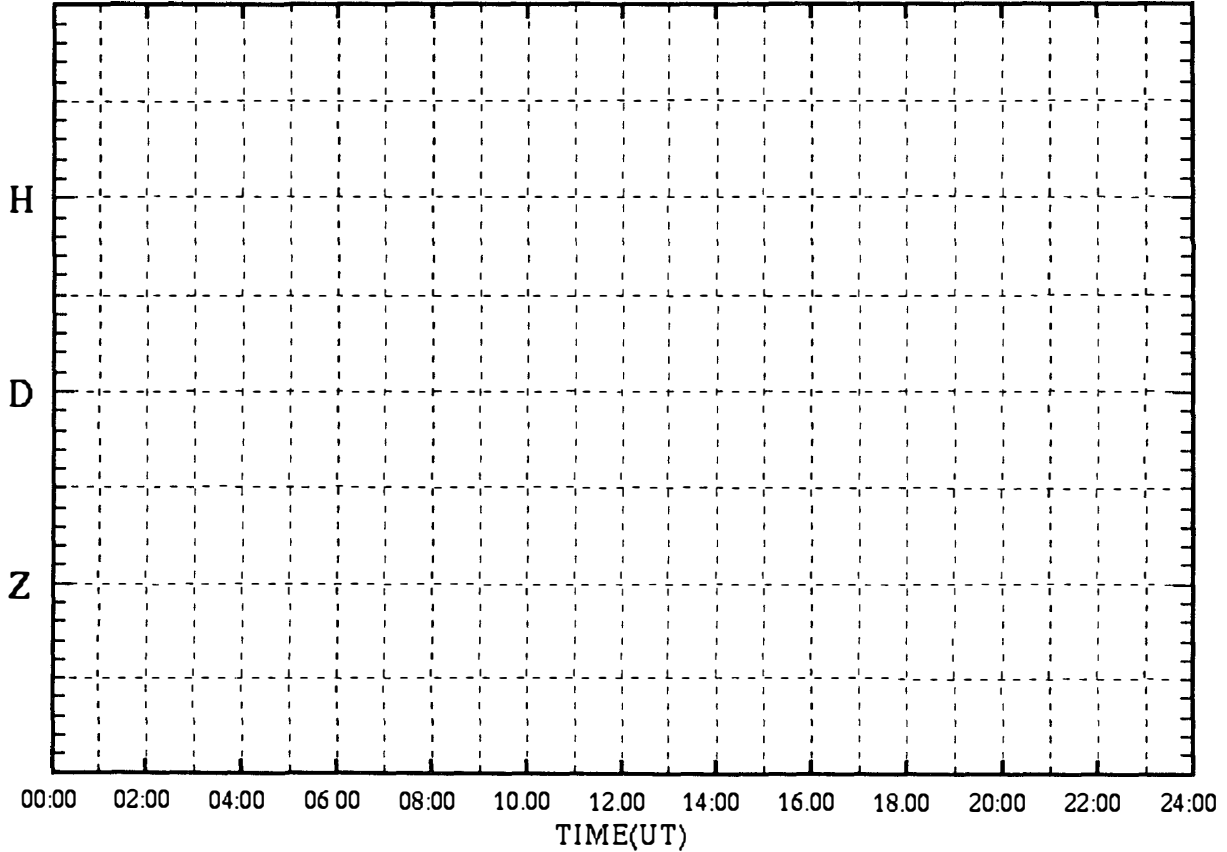

SYOWA magnetogram (100 nT/div)

10 Feb.1999 (DAY:041)

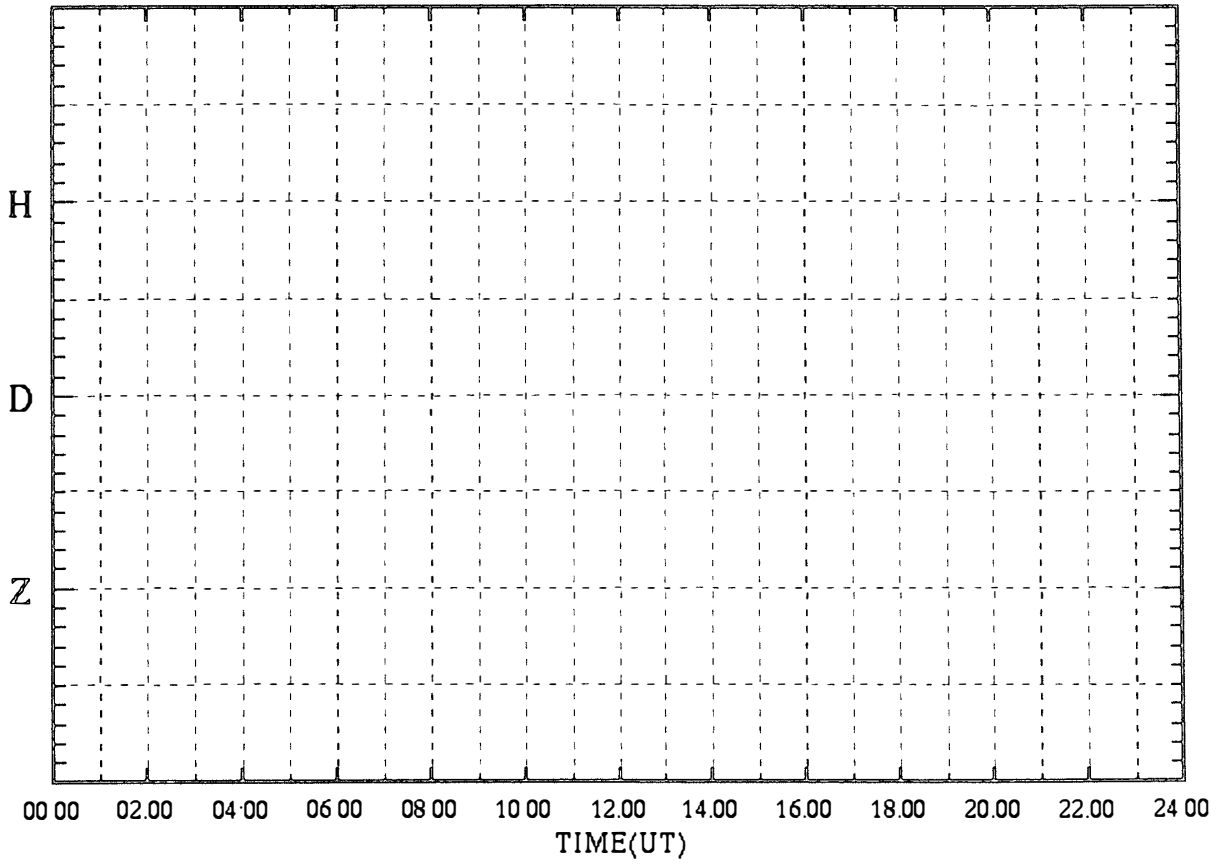

SYOWA magnetogram (100 nT/div)

11 Feb.1999 (DAY:042)

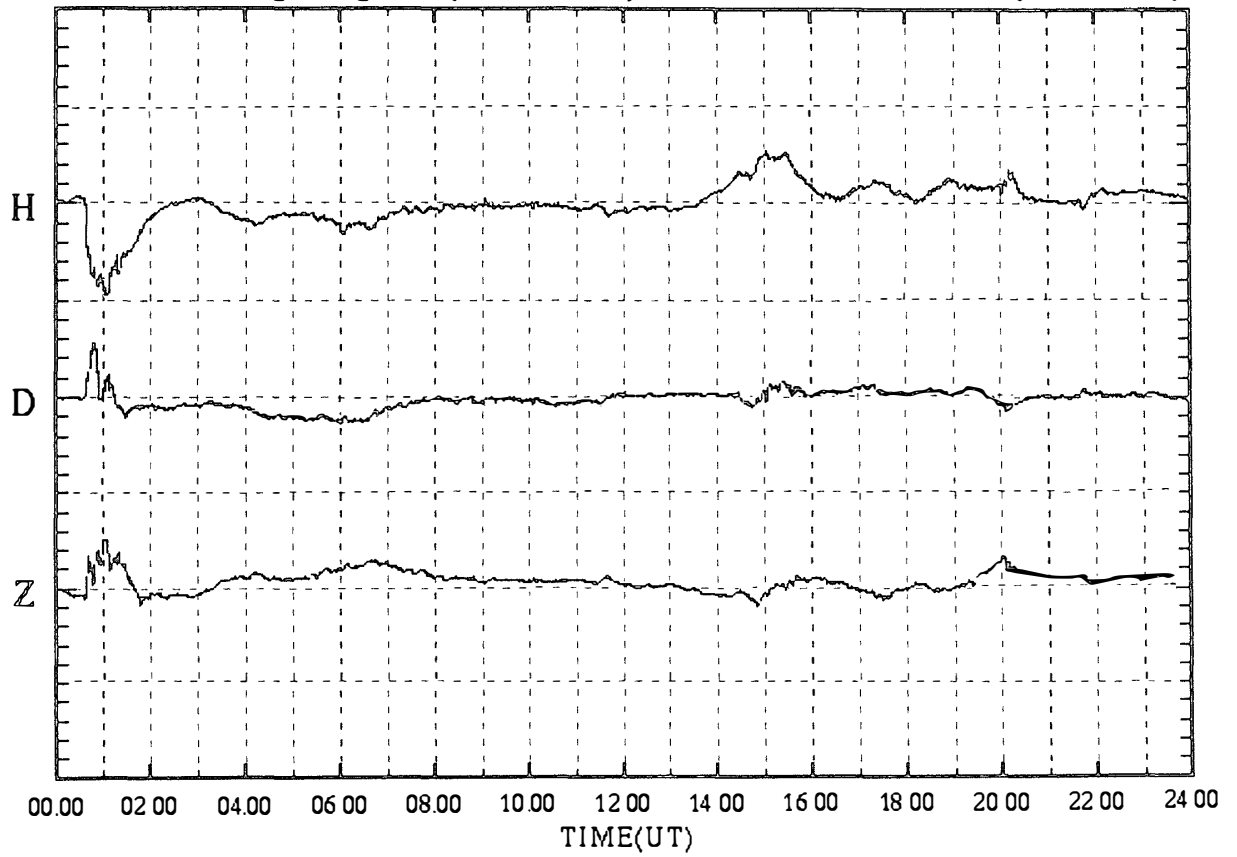

SYOWA magnetogram (100 nT/div)

12 Feb.1999 (DAY:043)

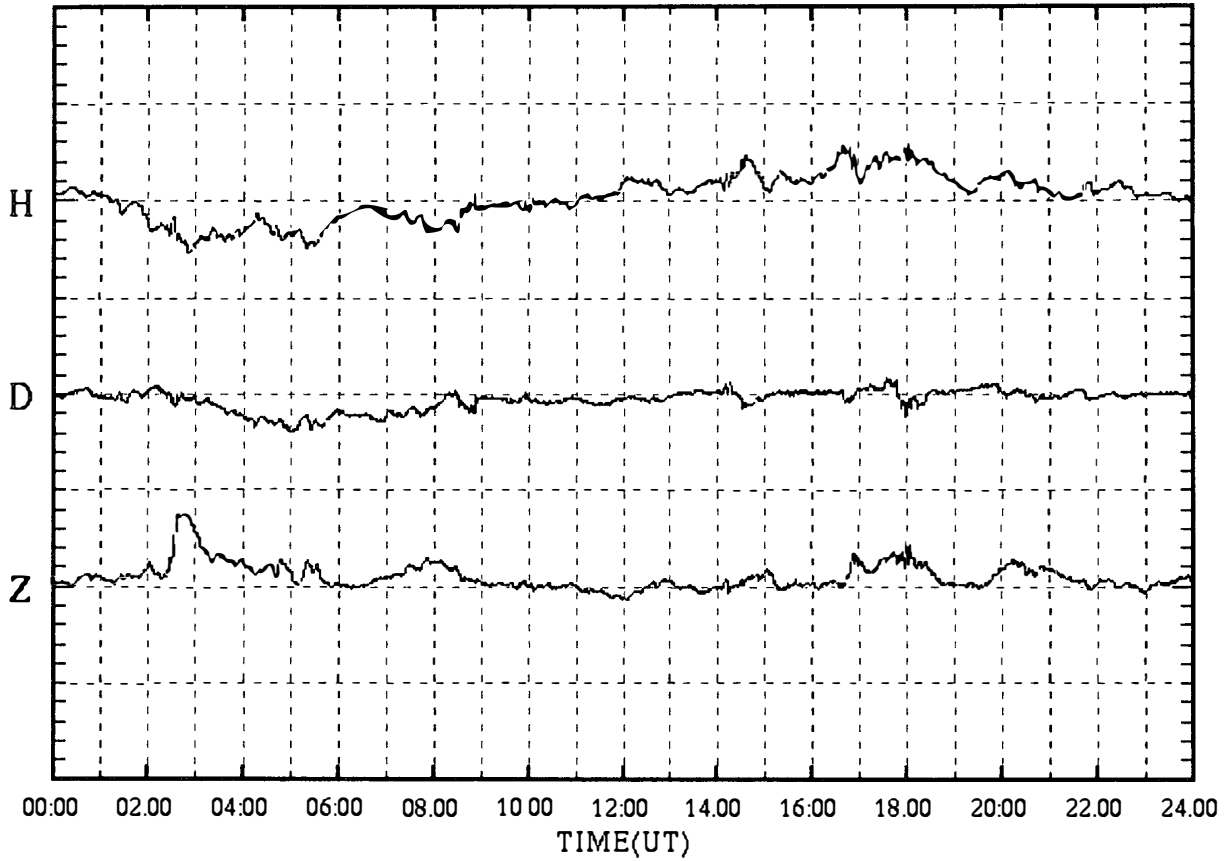

SYOWA magnetogram (100 nT/div)

13 Feb.1999 (DAY:044)

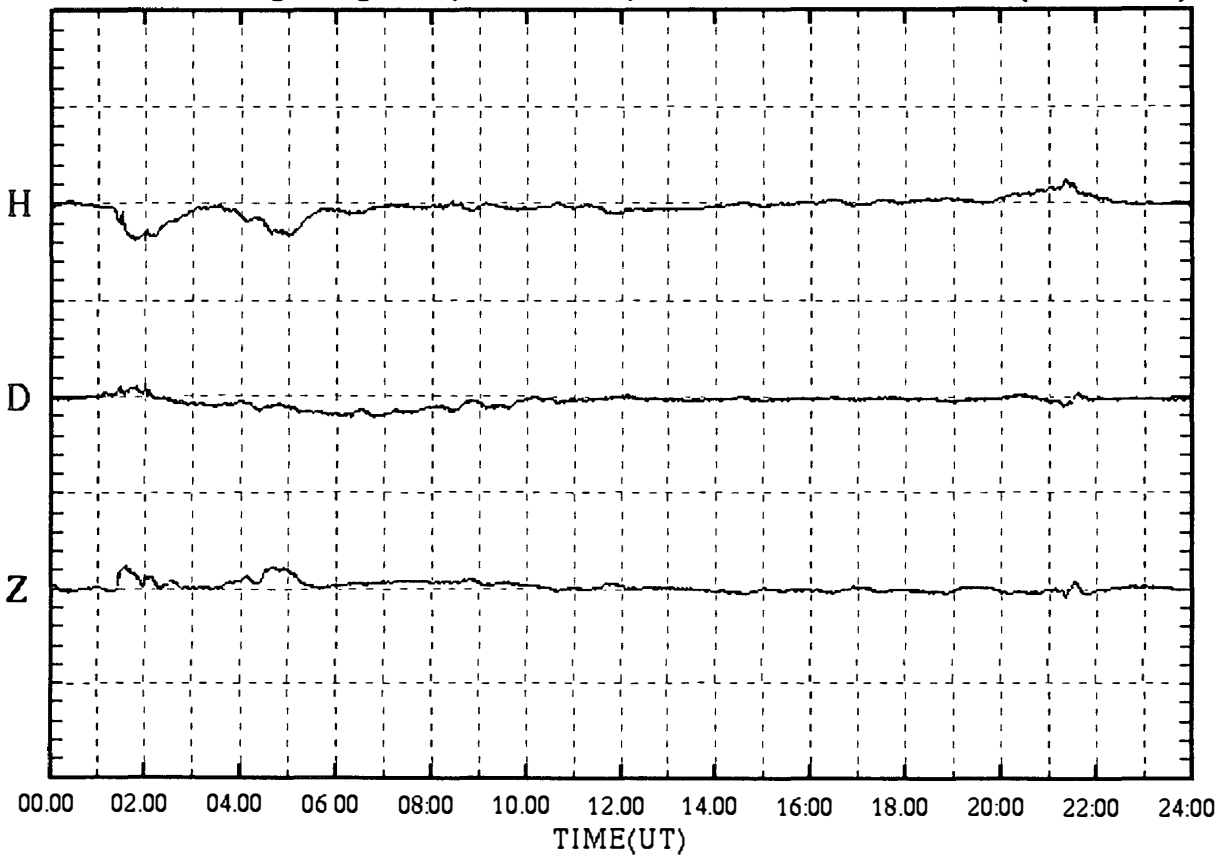

SYOWA magnetogram (100 nT/div)

14 Feb.1999 (DAY:045)

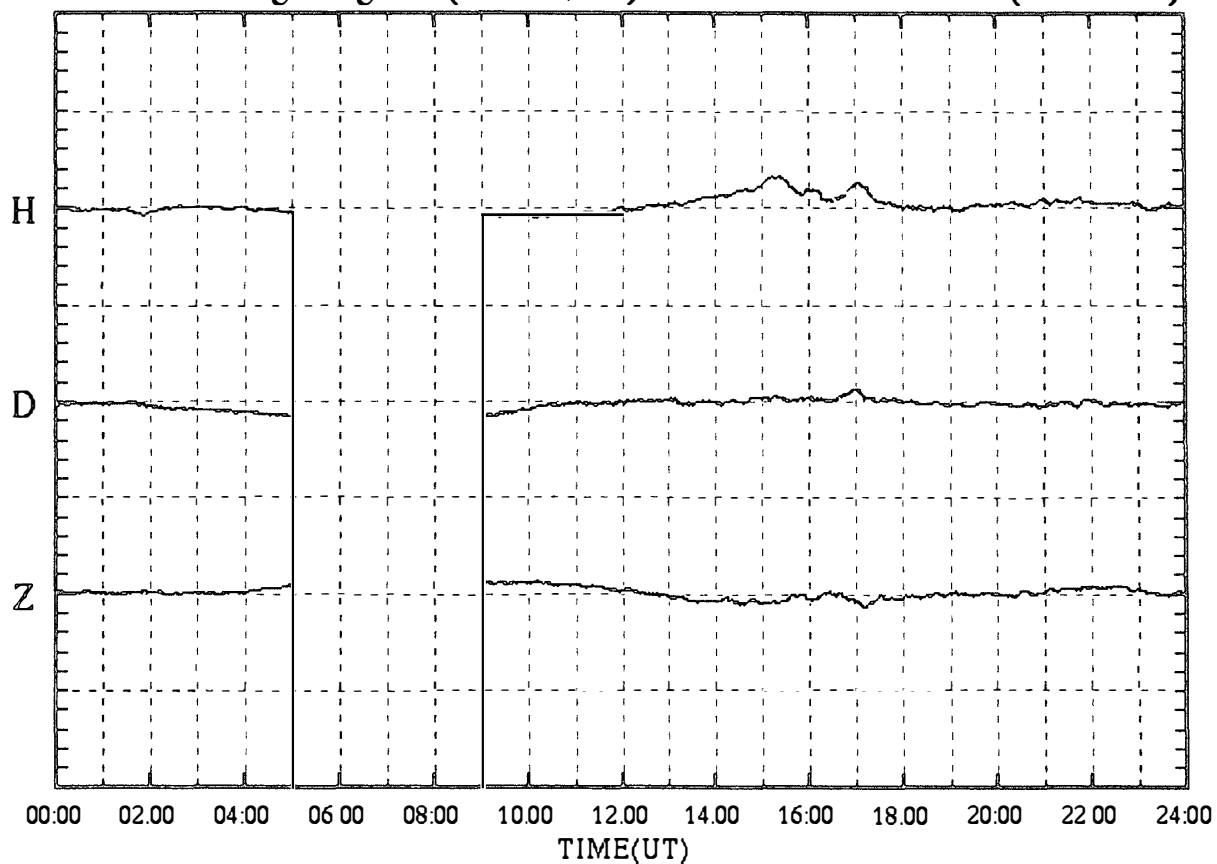

SYOWA magnetogram (100 nT/div)

15 Feb.1999 (DAY:046)

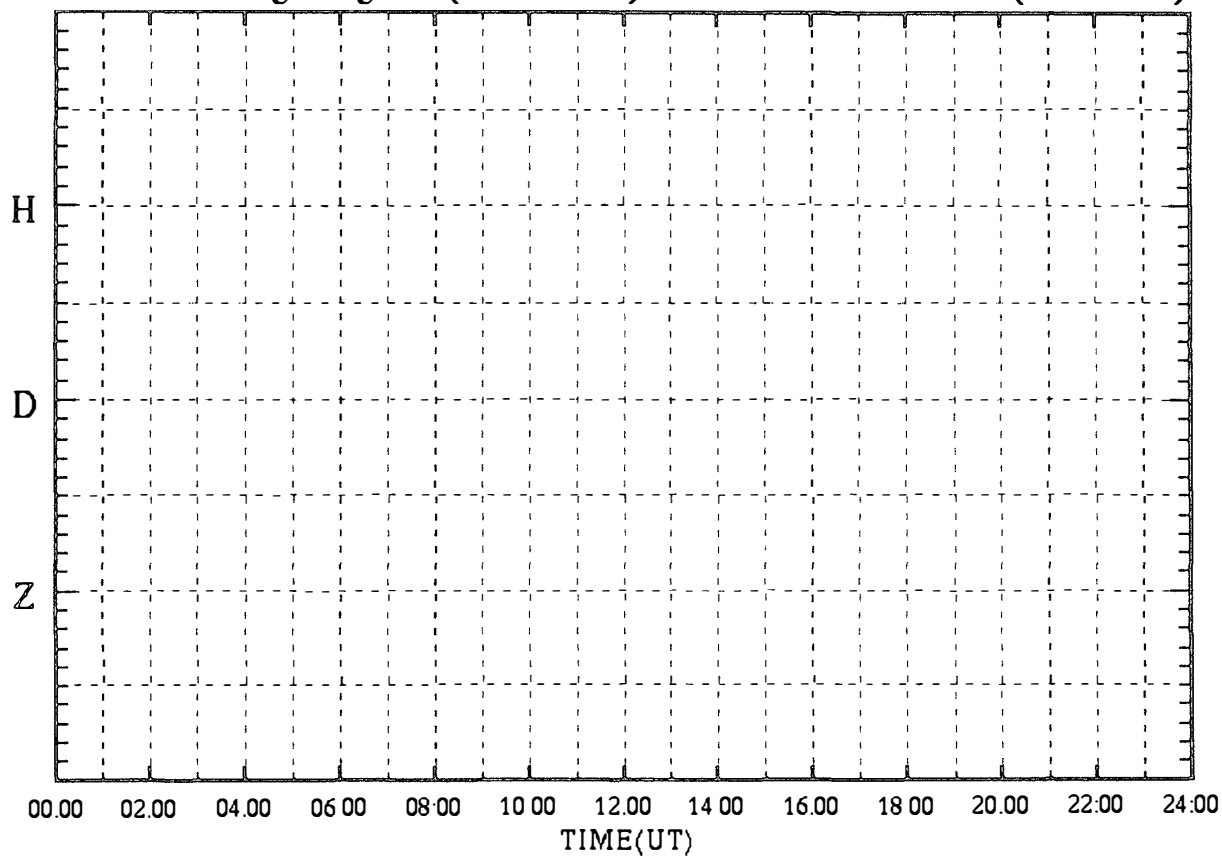

SYOWA magnetogram (100 nT/div)

16 Feb.1999 (DAY:047)

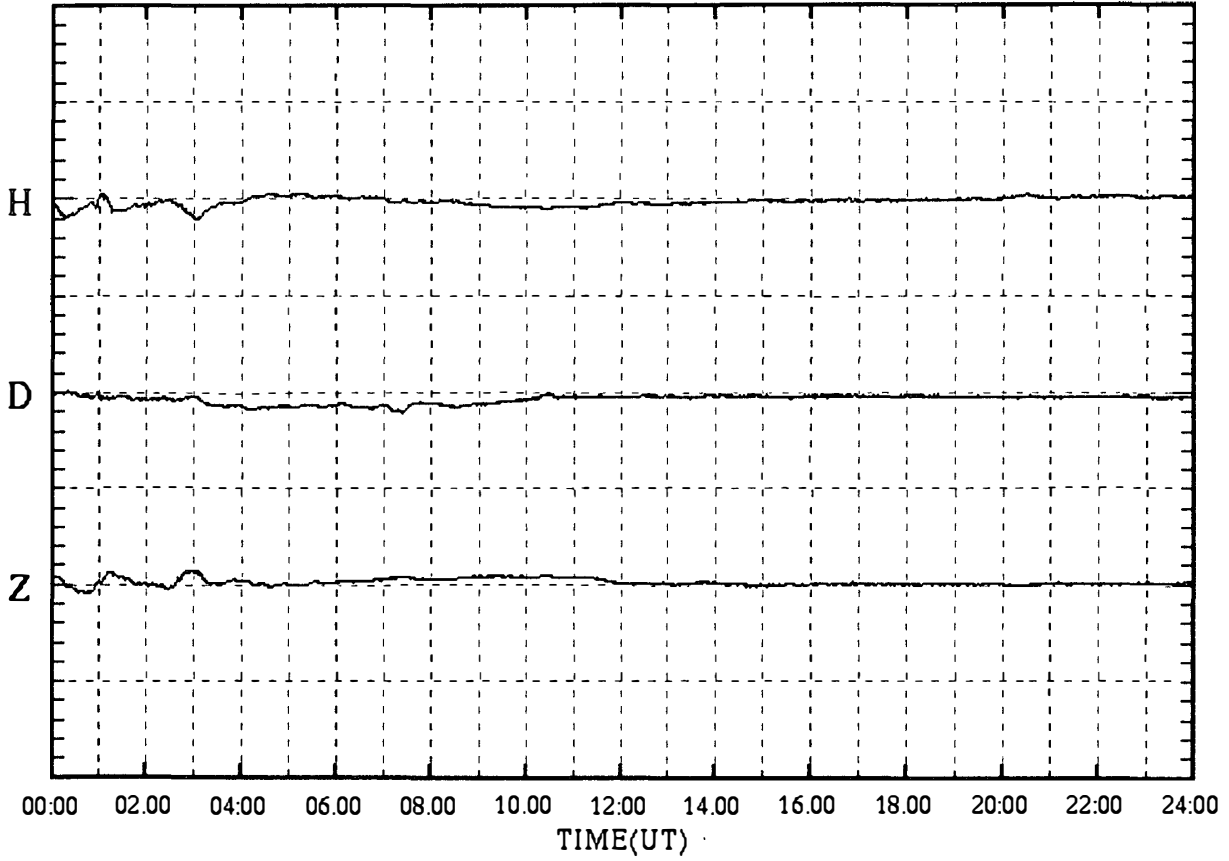

SYOWA magnetogram (100 nT/div)

17 Feb.1999 (DAY:048)

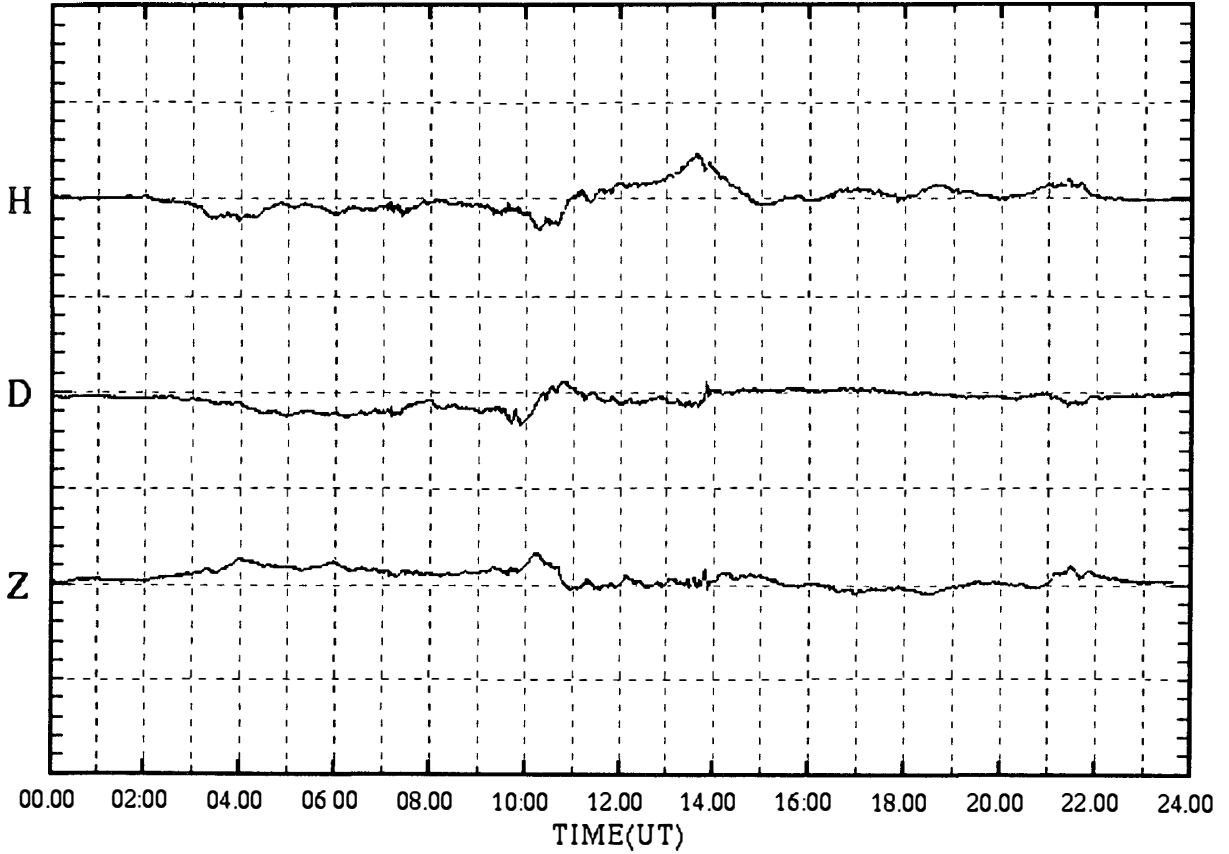



SYOWA magnetogram (100 nT/div)

18 Feb.1999 (DAY:049)

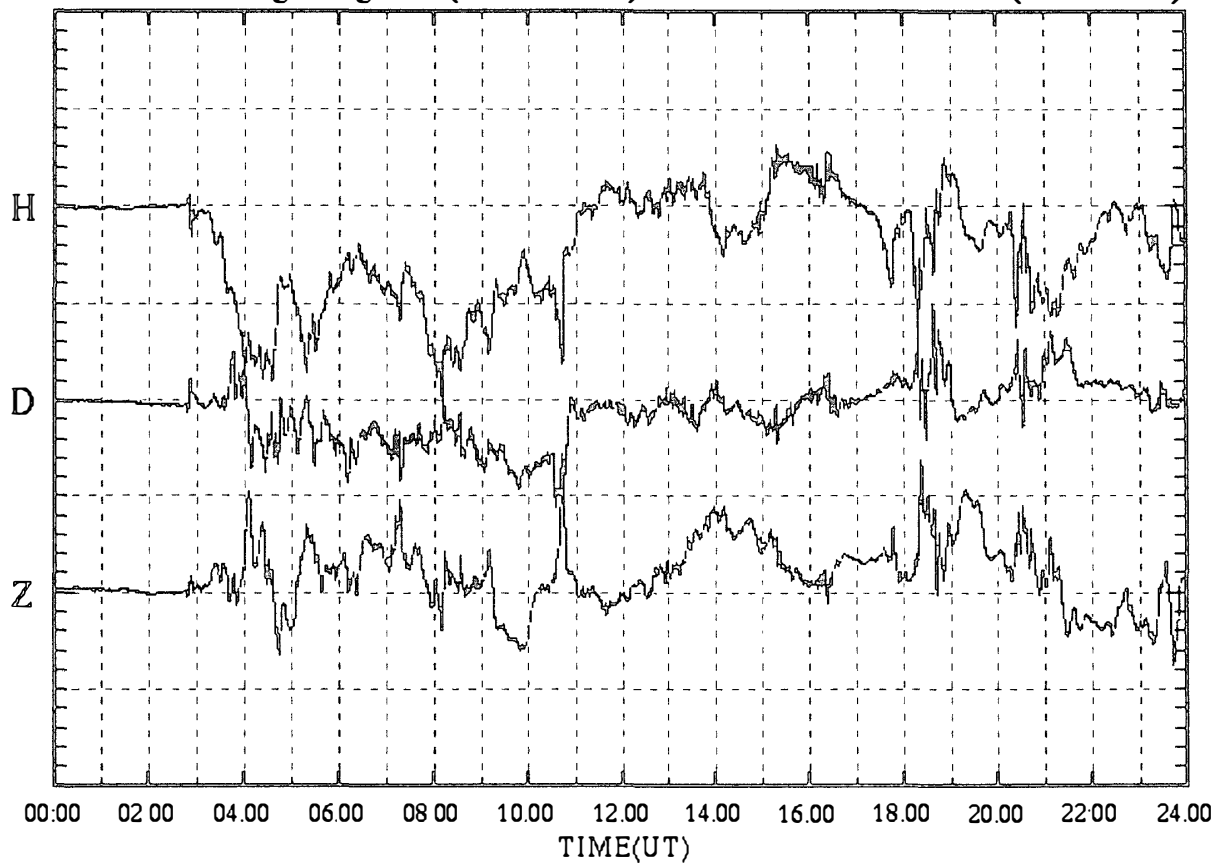

SYOWA magnetogram (100 nT/div)

19 Feb.1999 (DAY:050)

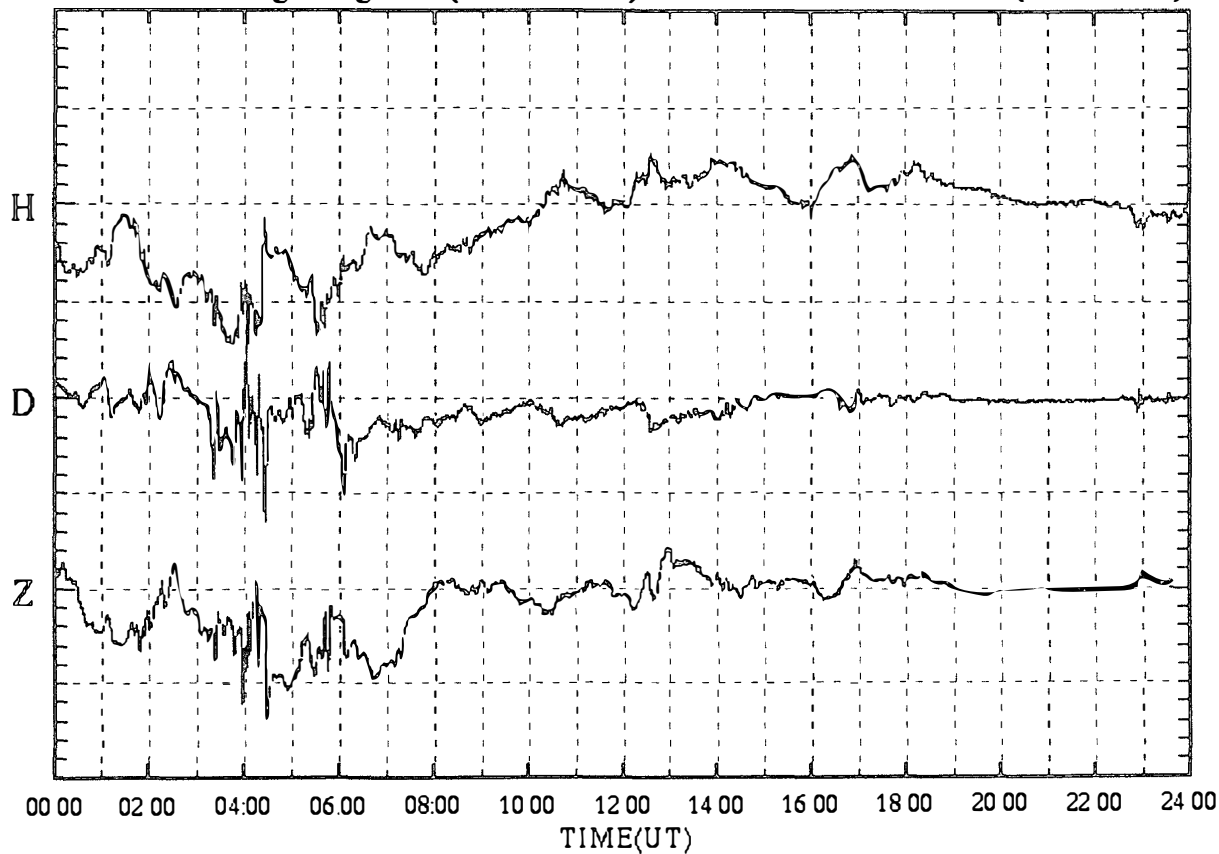

SYOWA magnetogram (100 nT/div)

20 Feb.1999 (DAY:051)

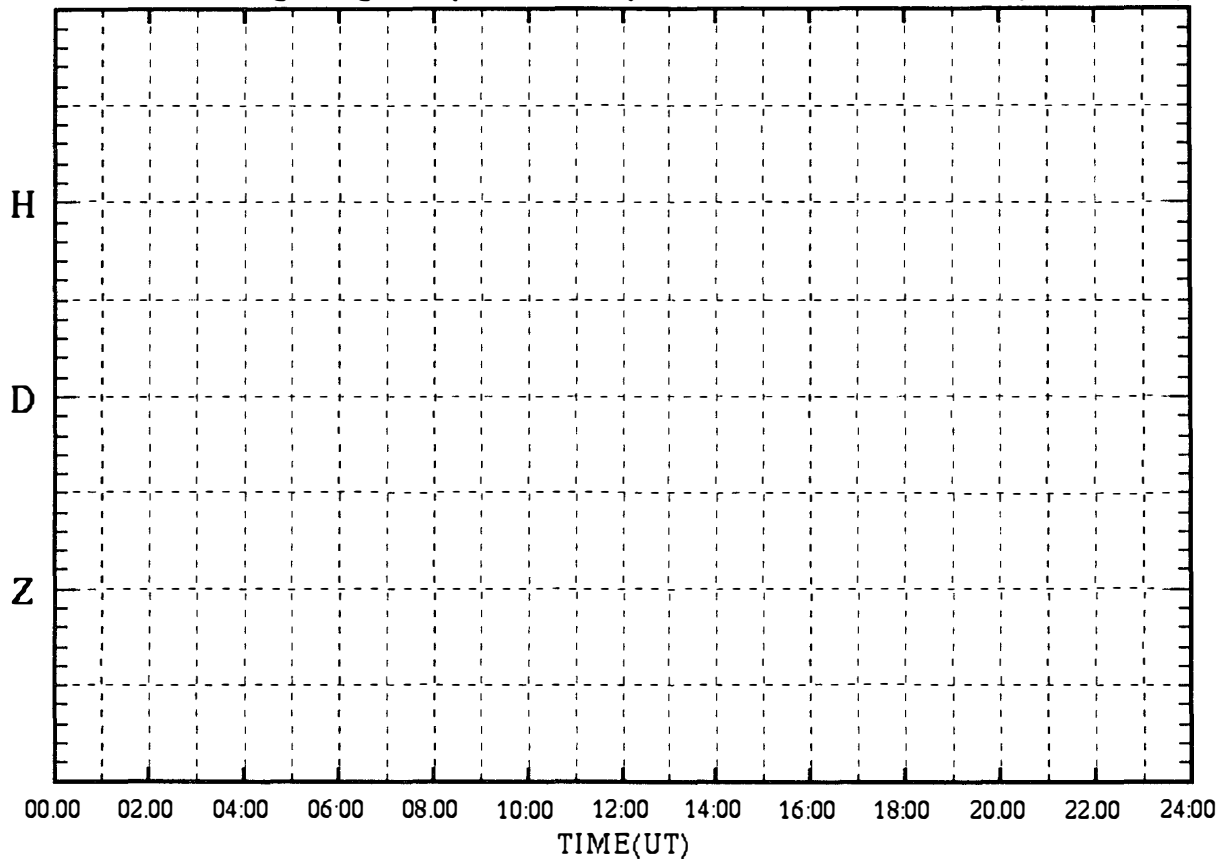

SYOWA magnetogram (100 nT/div)

21 Feb.1999 (DAY:052)

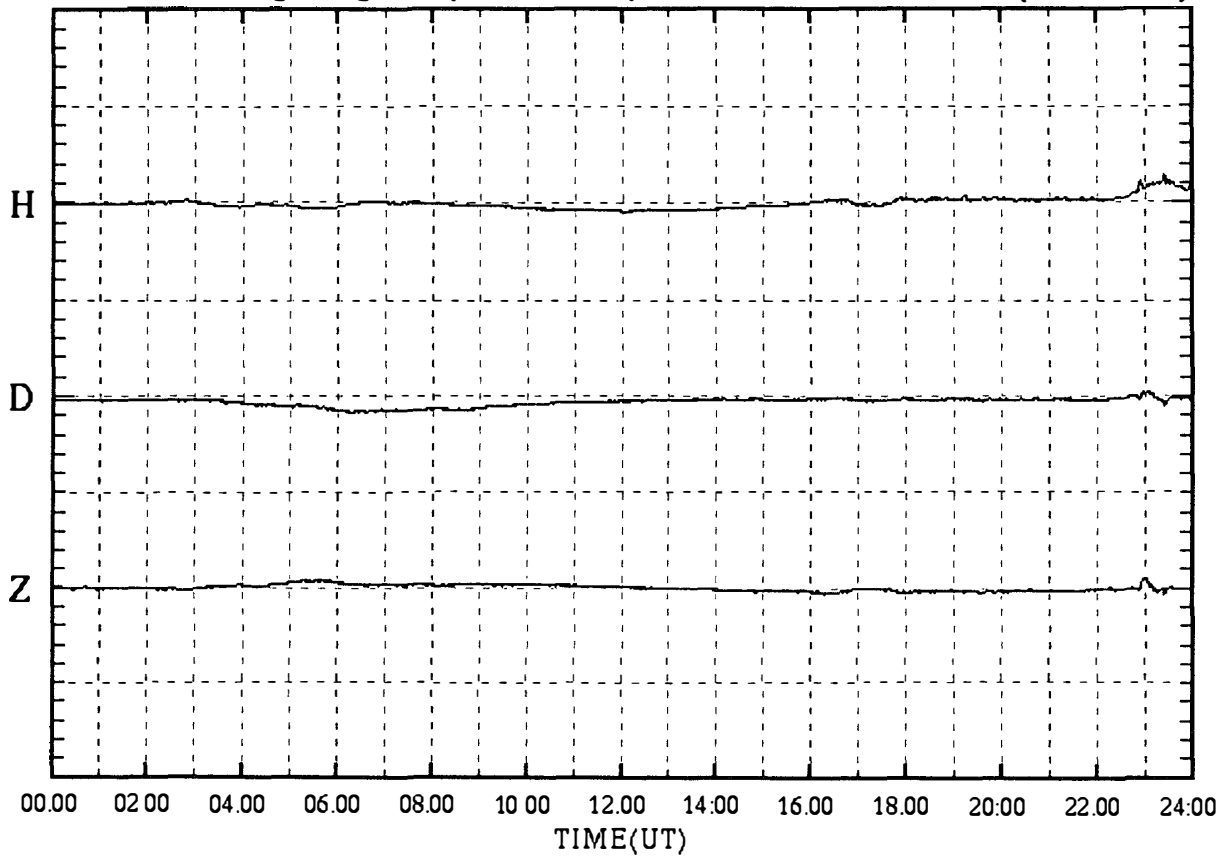

SYOWA magnetogram (100 nT/div)

22 Feb.1999 (DAY:053)

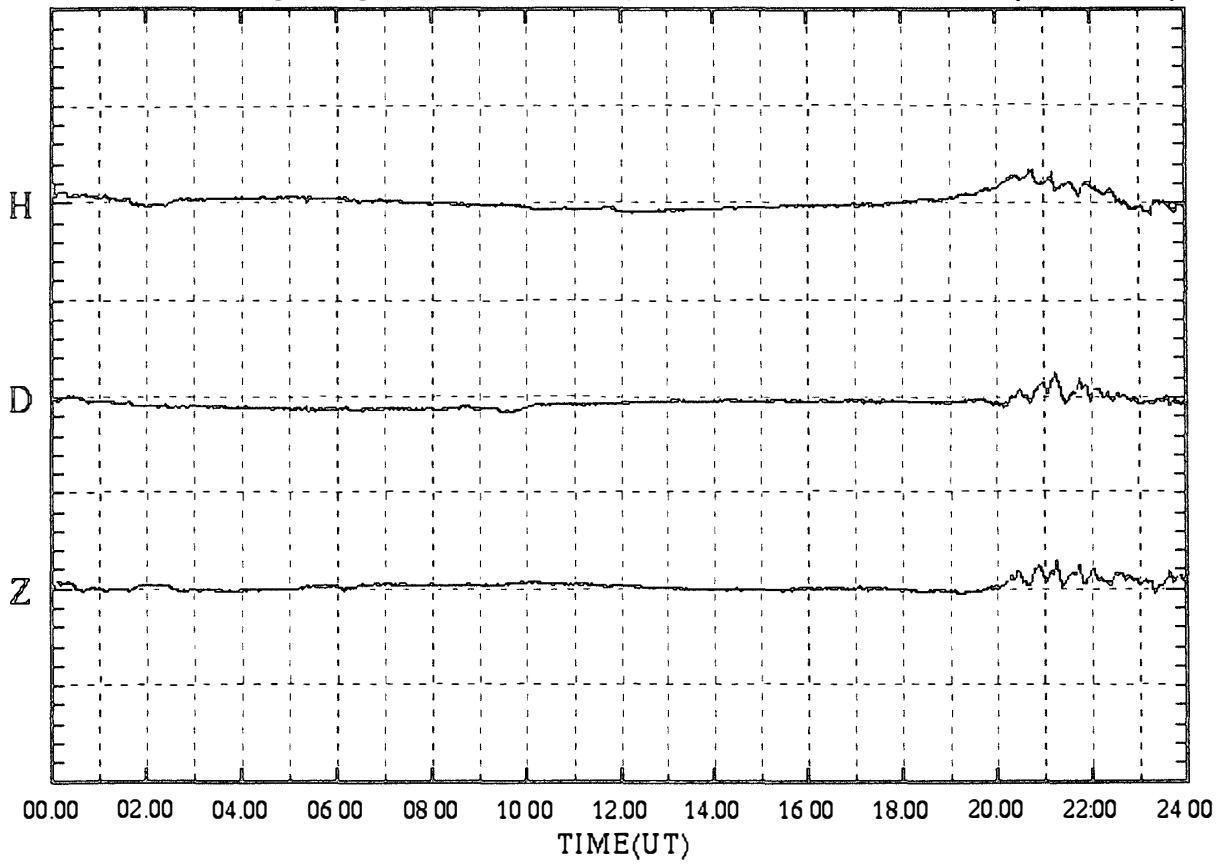

SYOWA magnetogram (100 nT/div)

23 Feb.1999 (DAY:054)

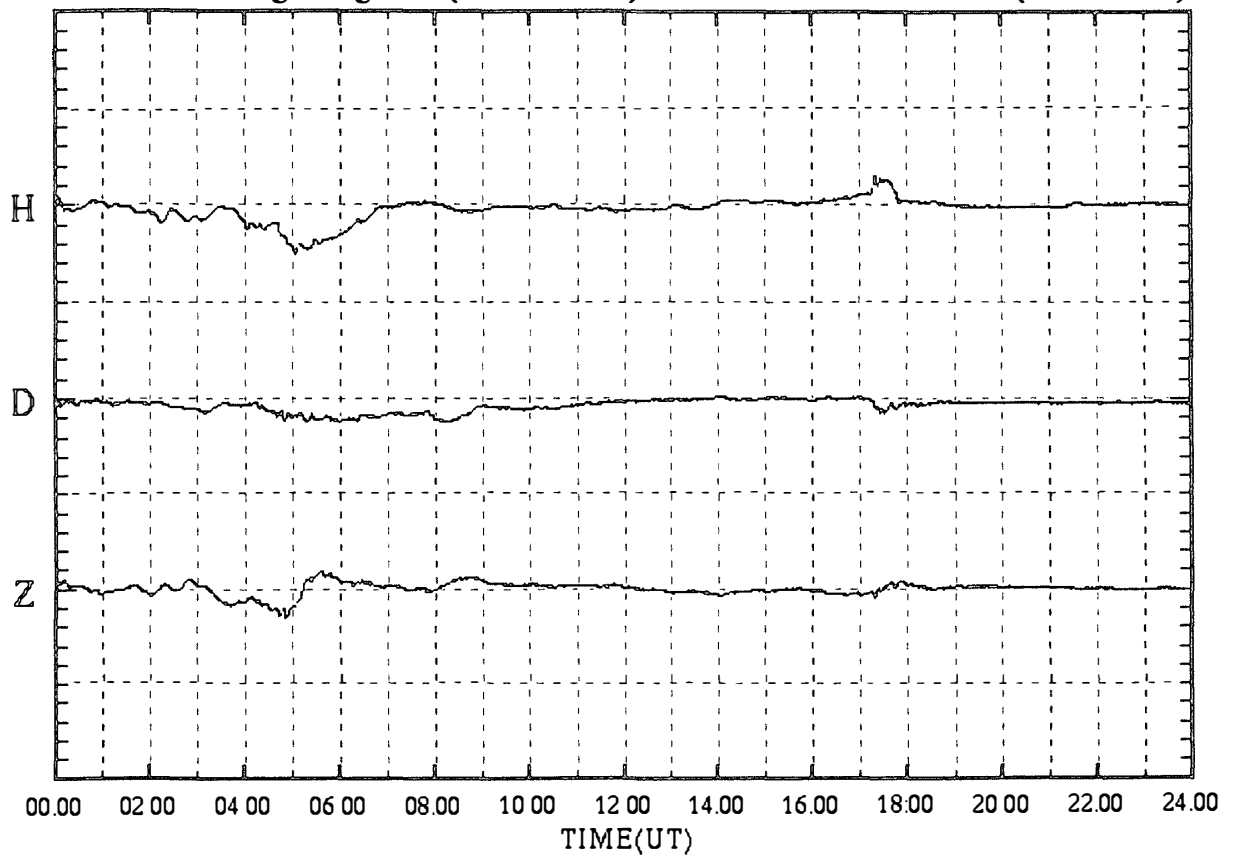

SYOWA magnetogram (100 nT/div)

24 Feb.1999 (DAY:055)

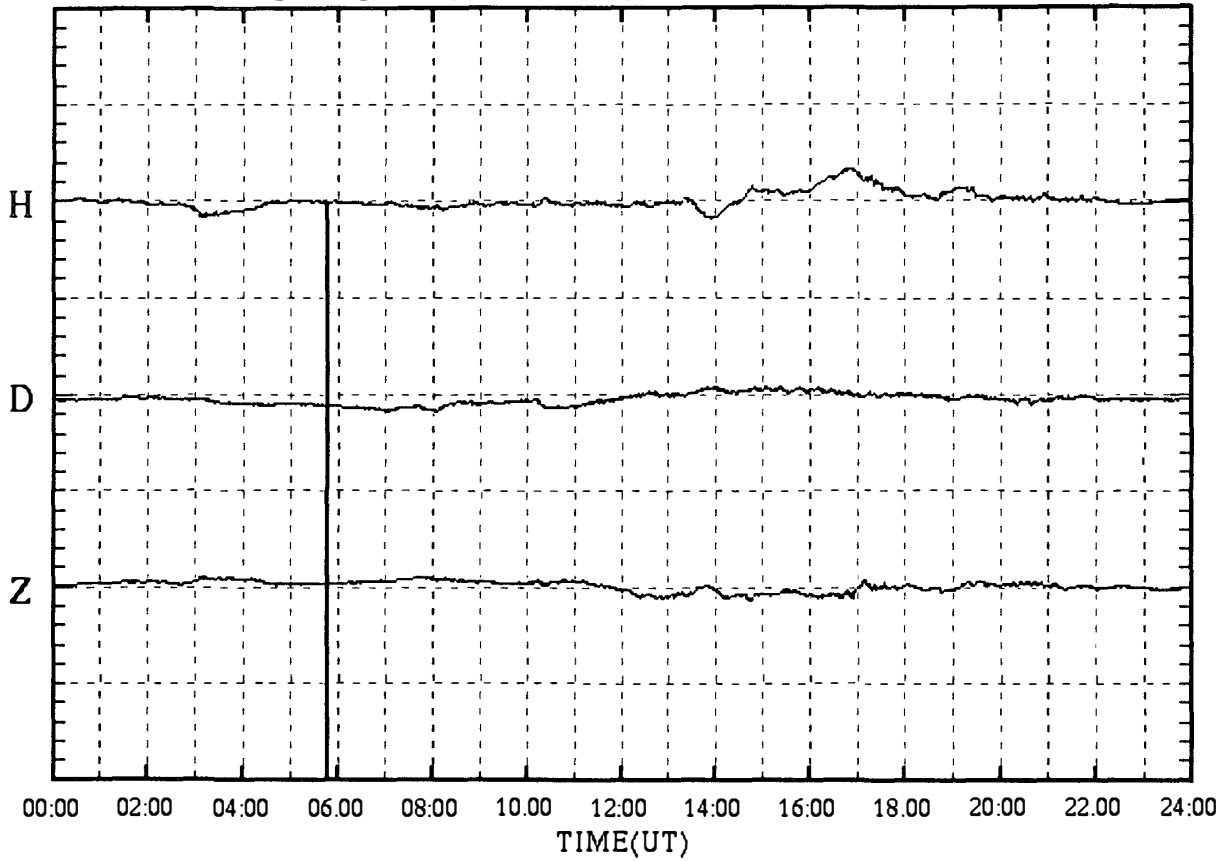

SYOWA magnetogram (100 nT/div)

25 Feb.1999 (DAY:056)

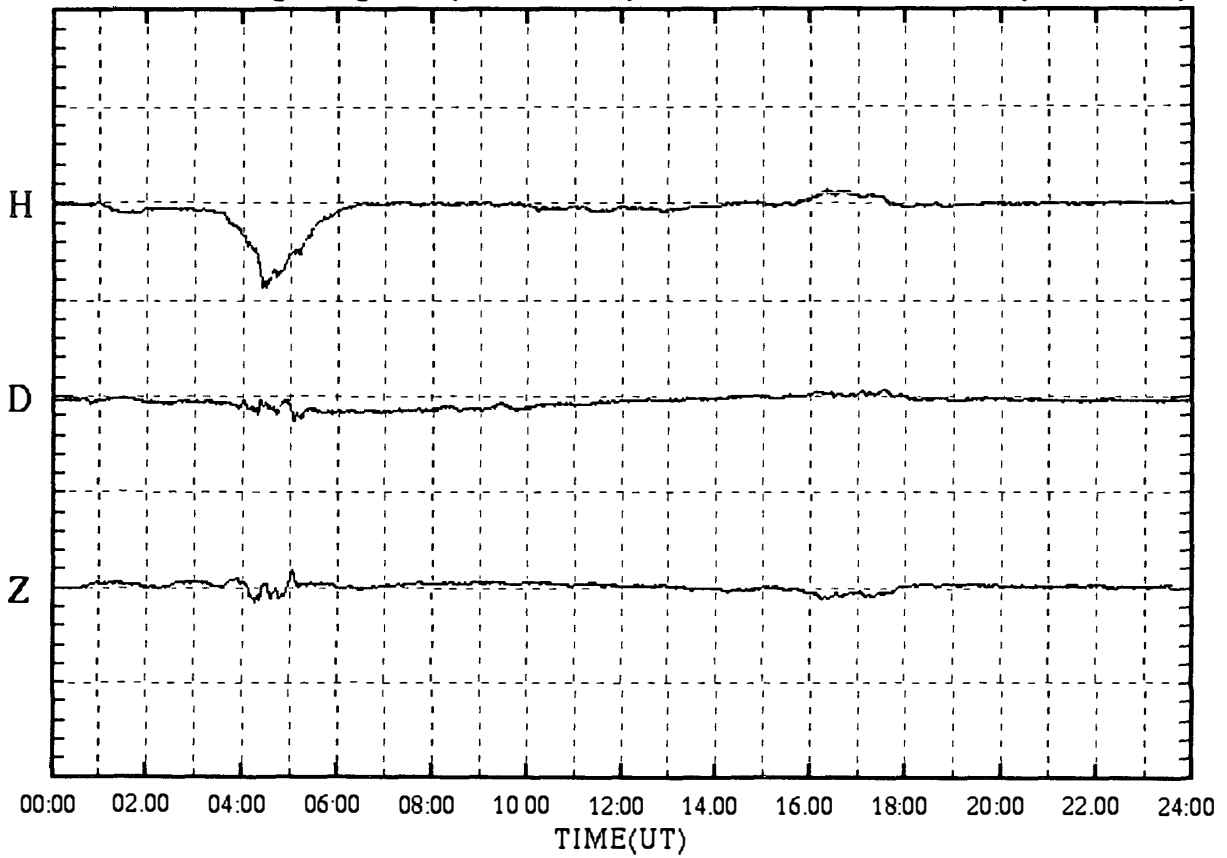

SYOWA magnetogram (100 nT/div)

26 Feb.1999 (DAY:057)

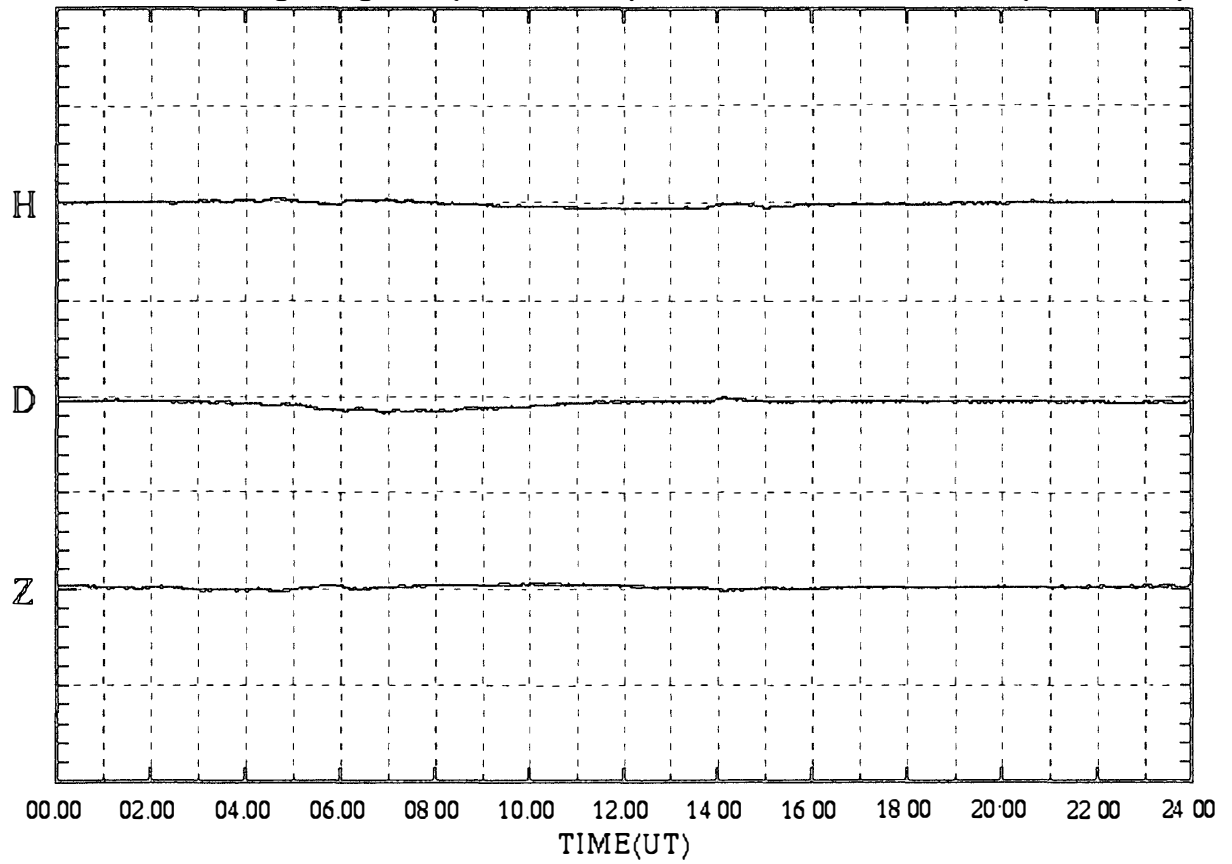

SYOWA magnetogram (100 nT/div)

27 Feb.1999 (DAY:058)

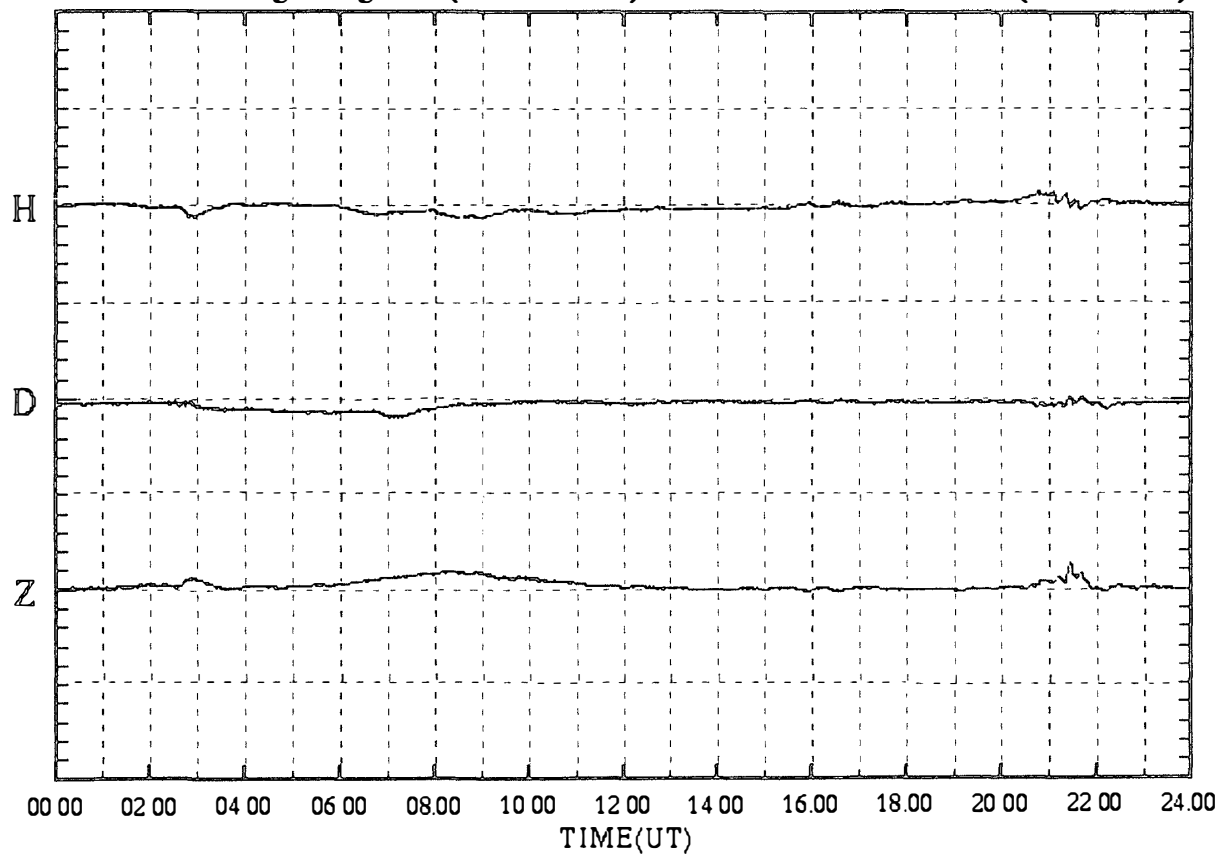

SYOWA magnetogram (100 nT/div)

28 Feb.1999 (DAY:059)

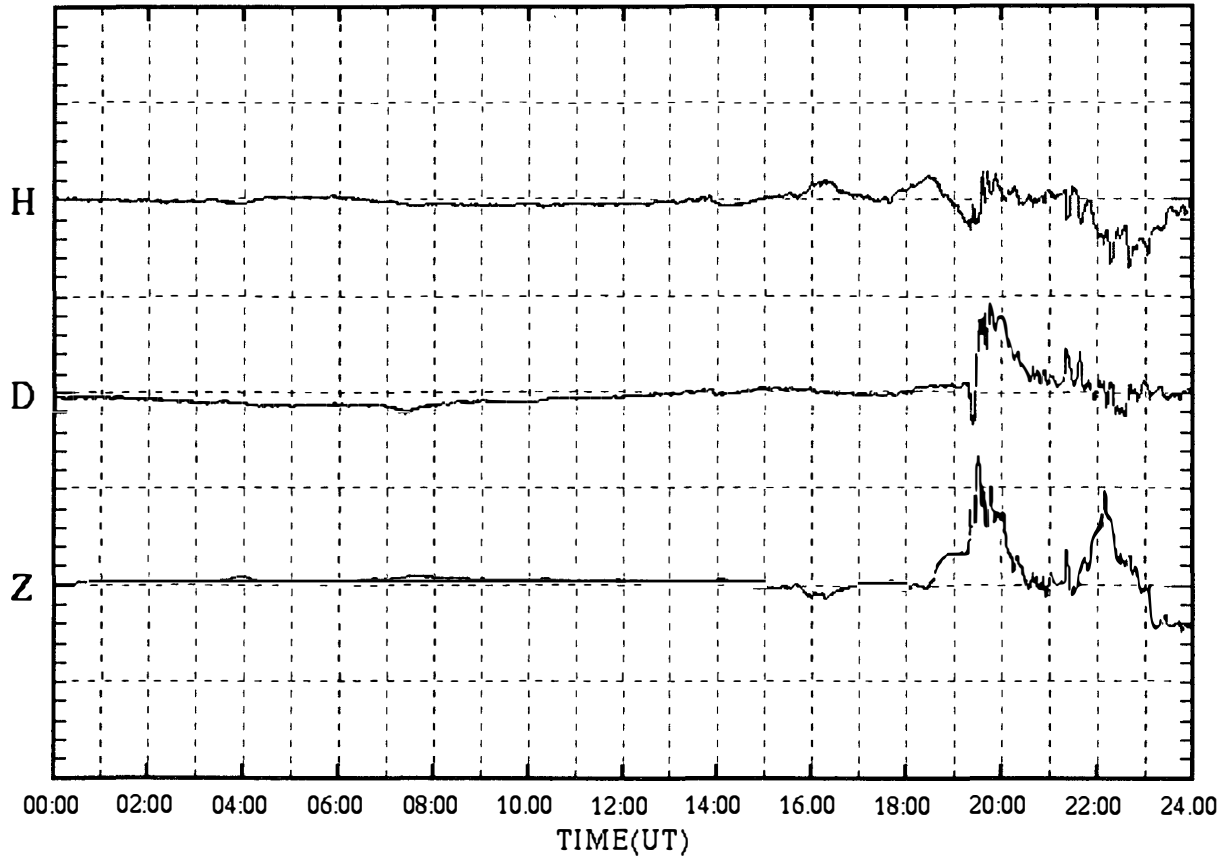

SYOWA magnetogram (100 nT/div)

01 Mar.1999 (DAY:060)

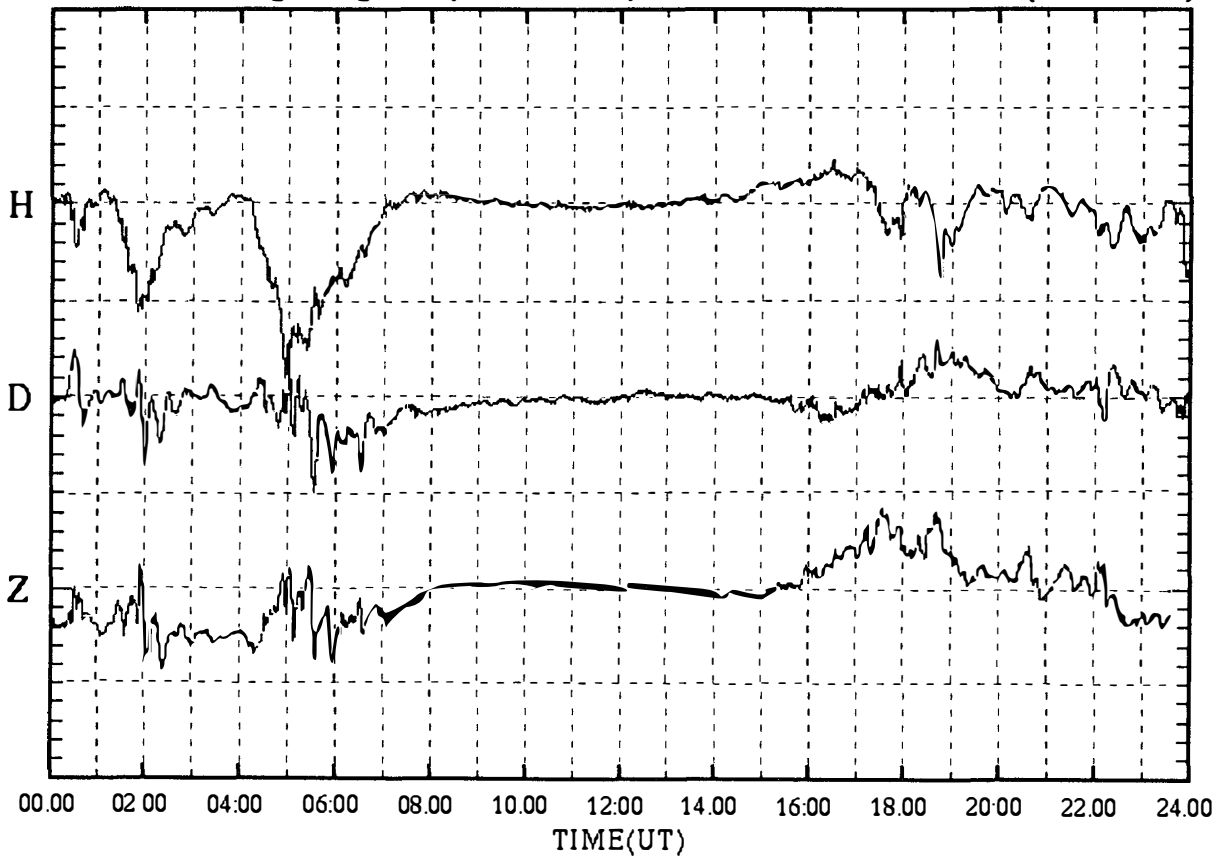

SYOWA magnetogram (100 nT/div)

02 Mar.1999 (DAY:061)

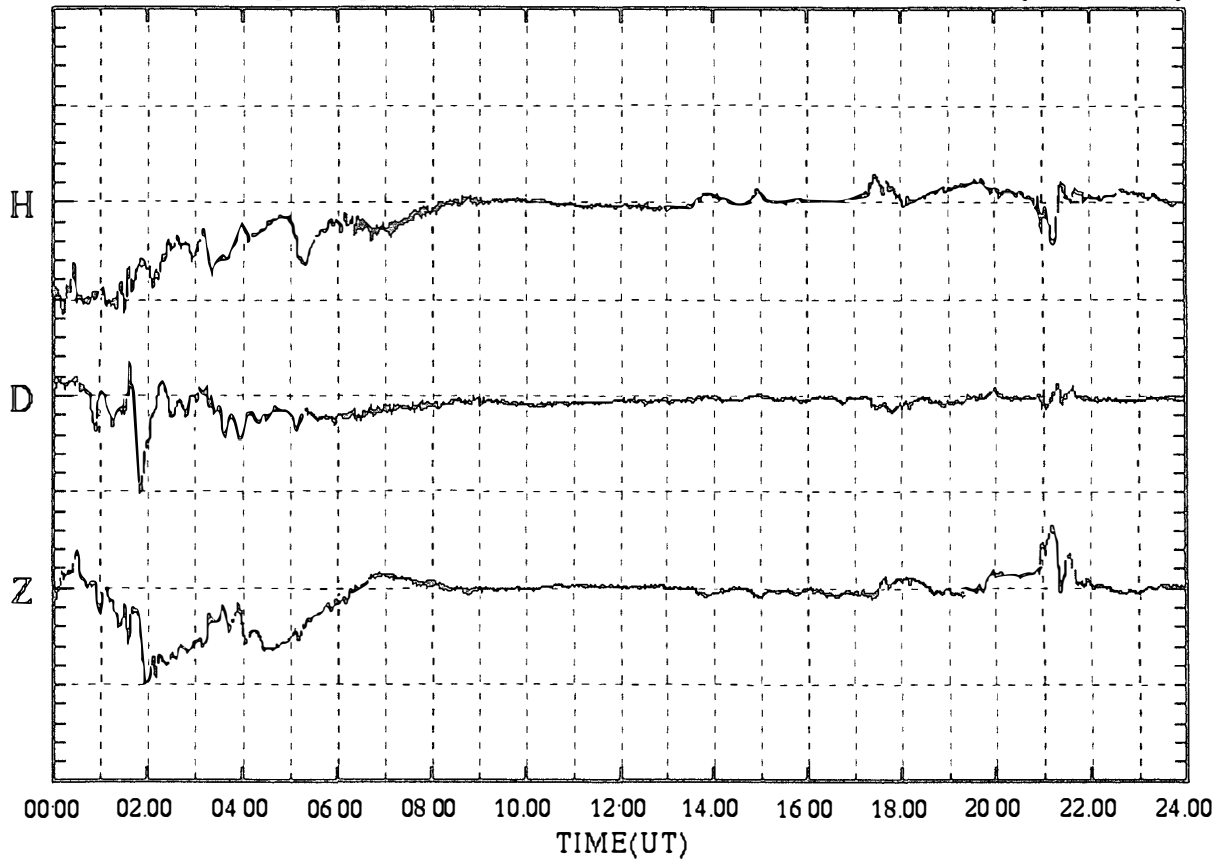

SYOWA magnetogram (100 nT/div)

03 Mar.1999 (DAY:062)

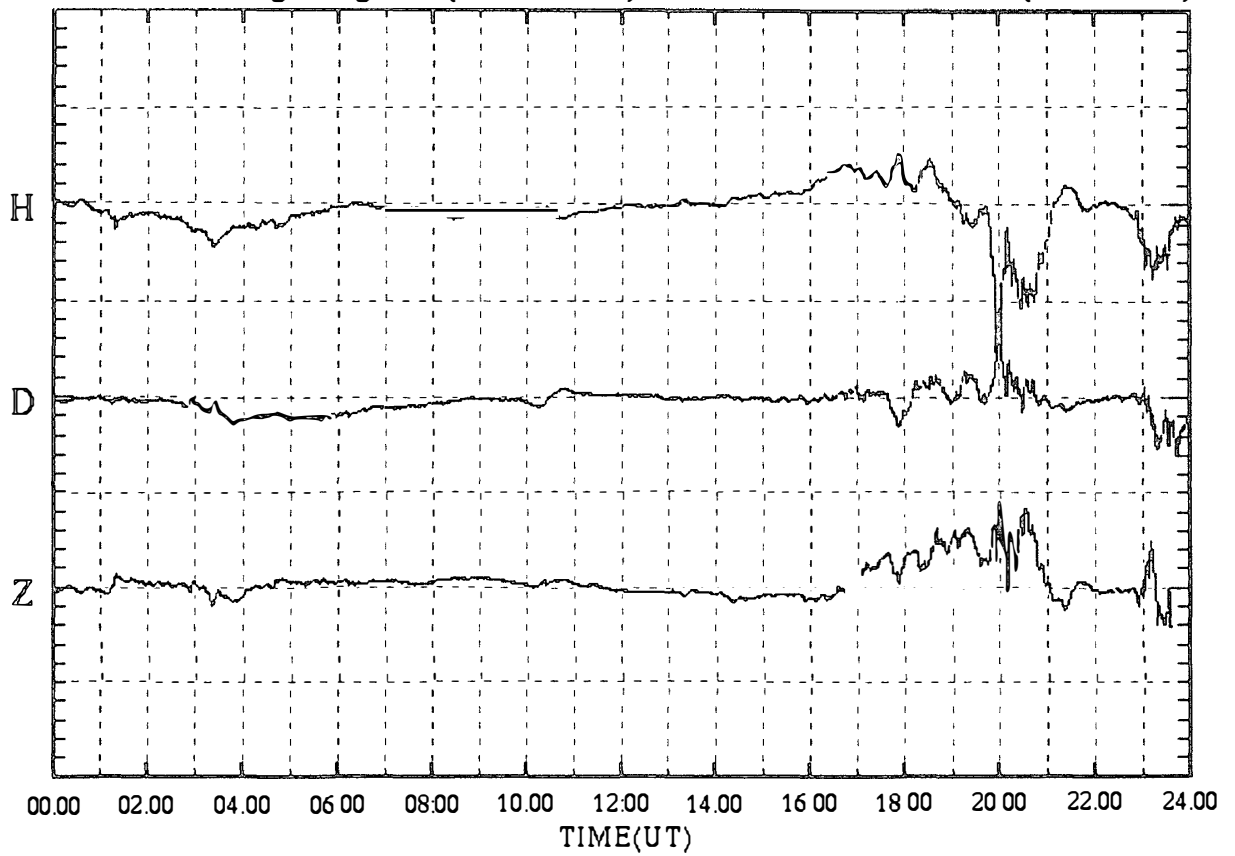

SYOWA magnetogram (100 nT/div)

04 Mar.1999 (DAY:063)

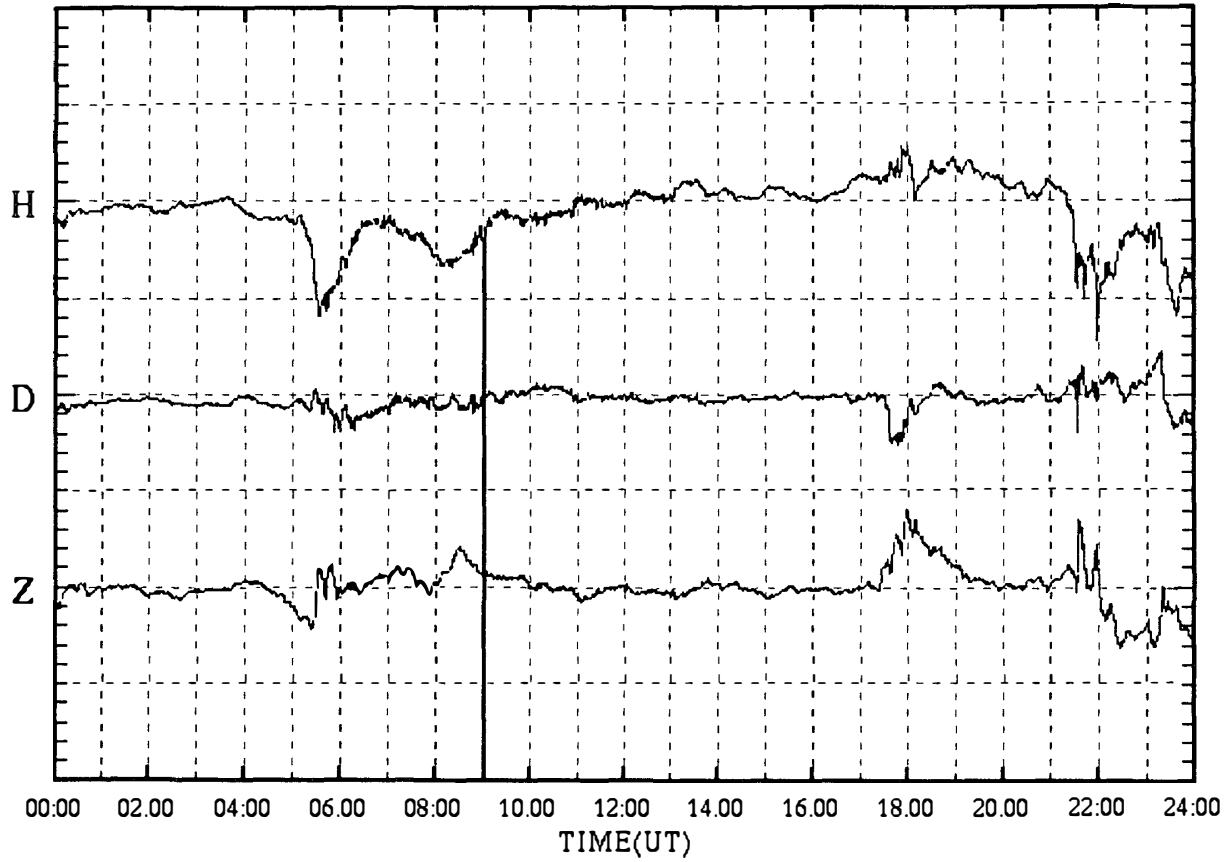

SYOWA magnetogram (100 nT/div)

05 Mar.1999 (DAY:064)

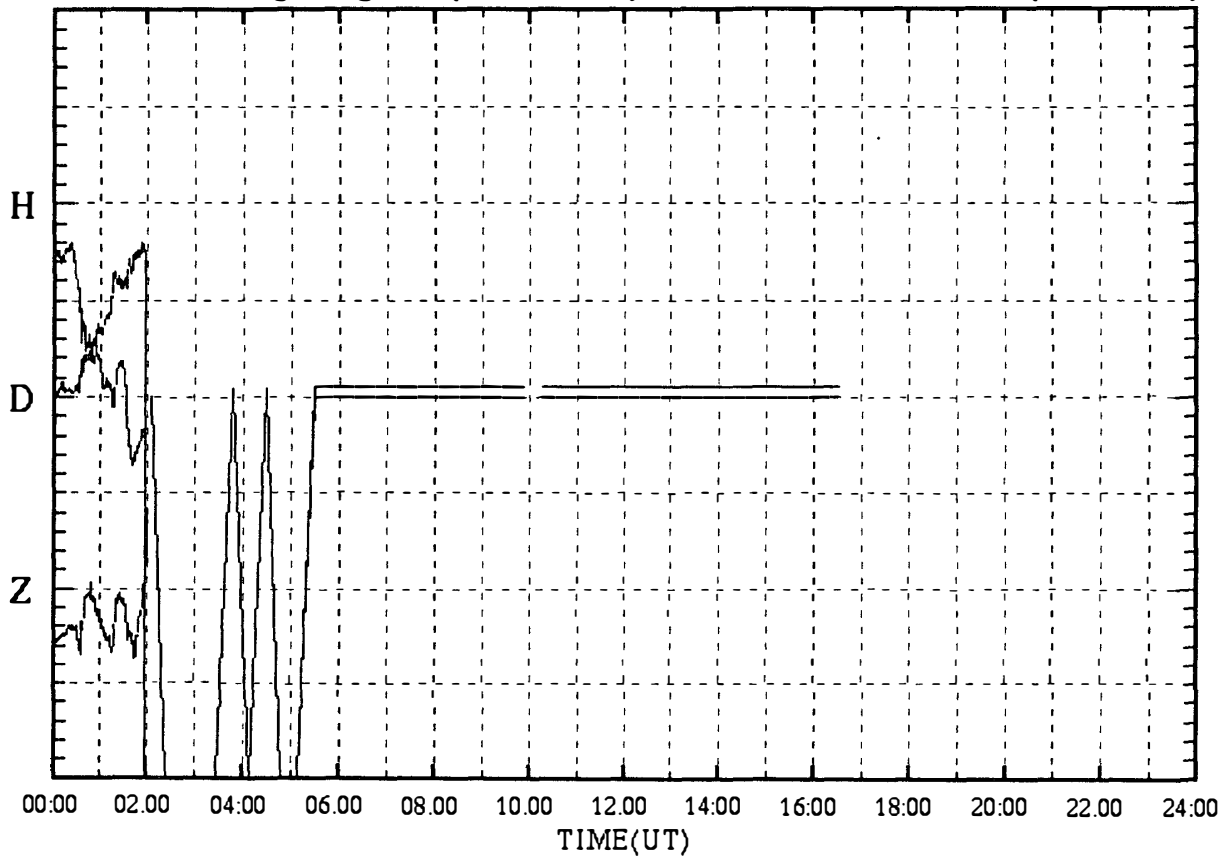



SYOWA magnetogram (100 nT/div)

06 Mar.1999 (DAY:065)

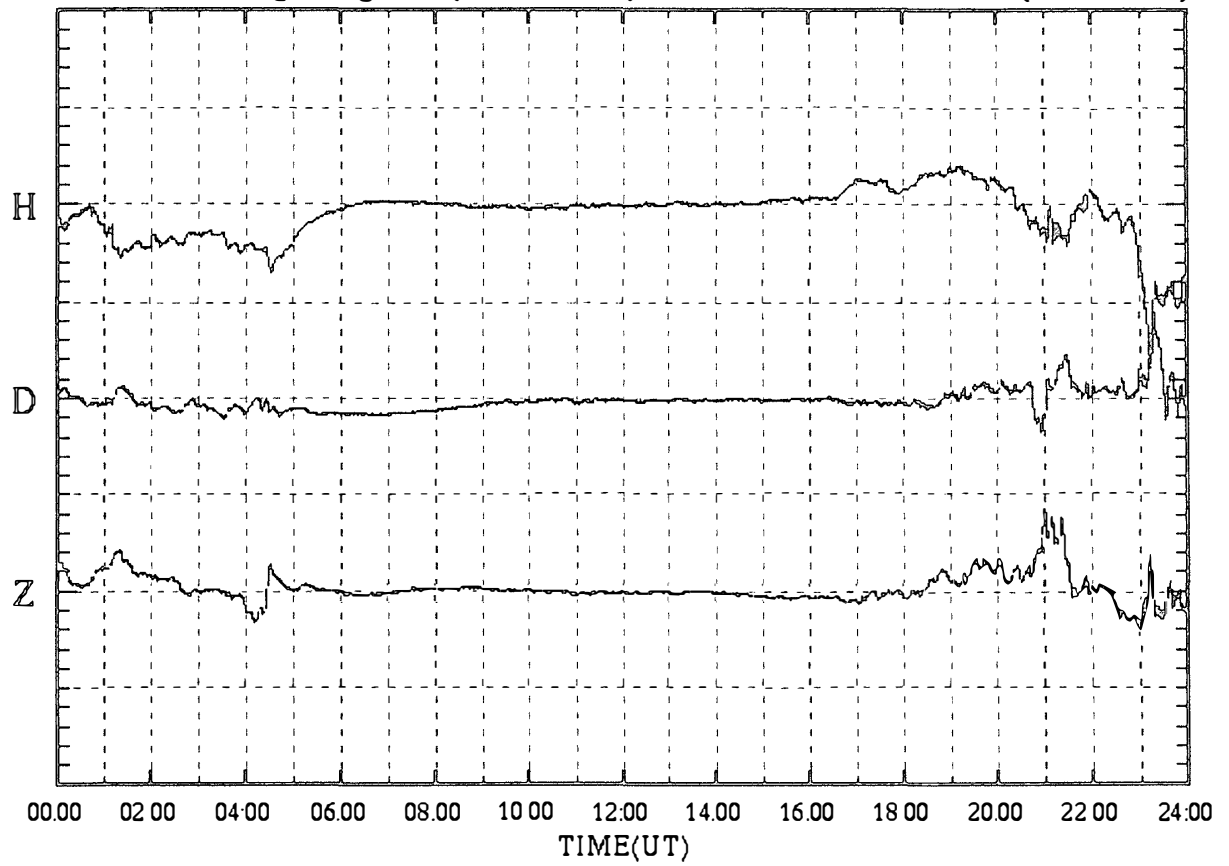

SYOWA magnetogram (100 nT/div)

07 Mar.1999 (DAY:066)

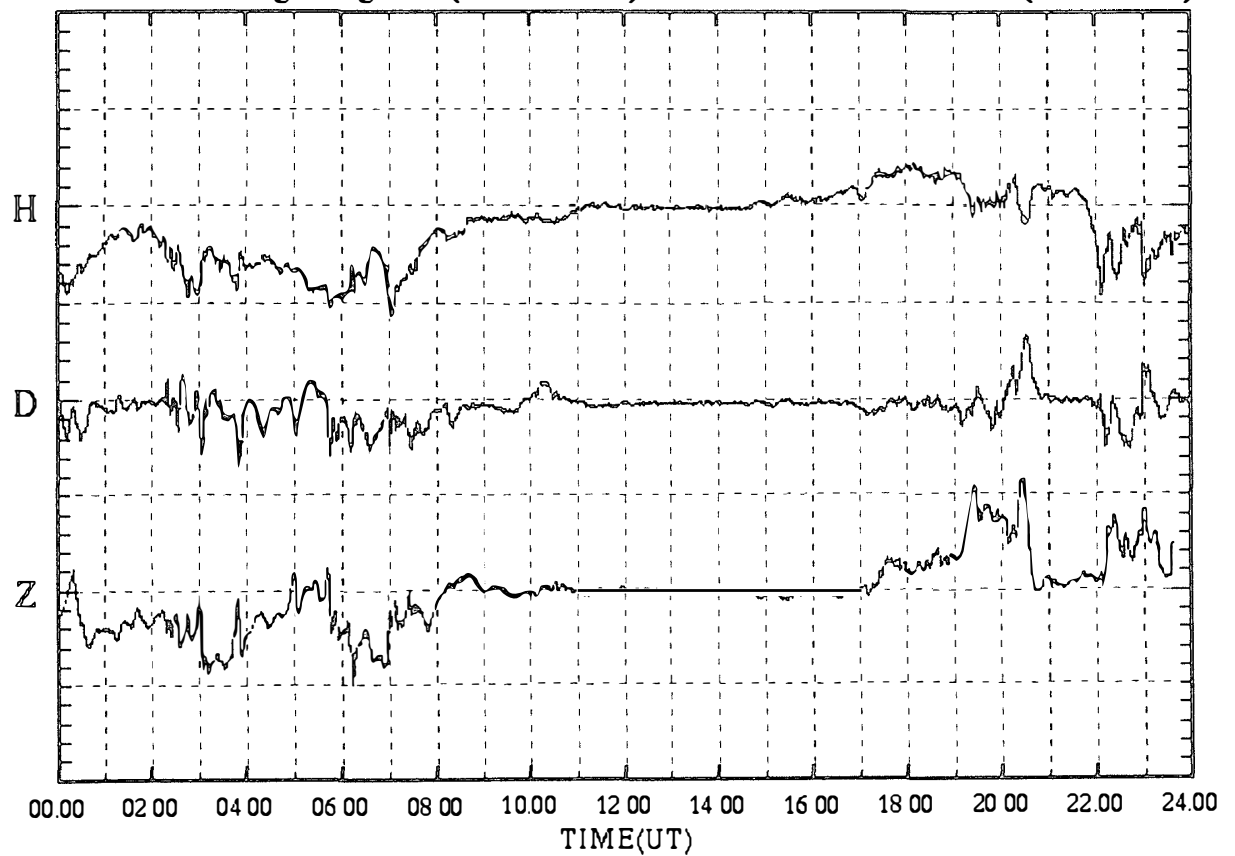

SYOWA magnetogram (100 nT/div)

08 Mar.1999 (DAY:067)

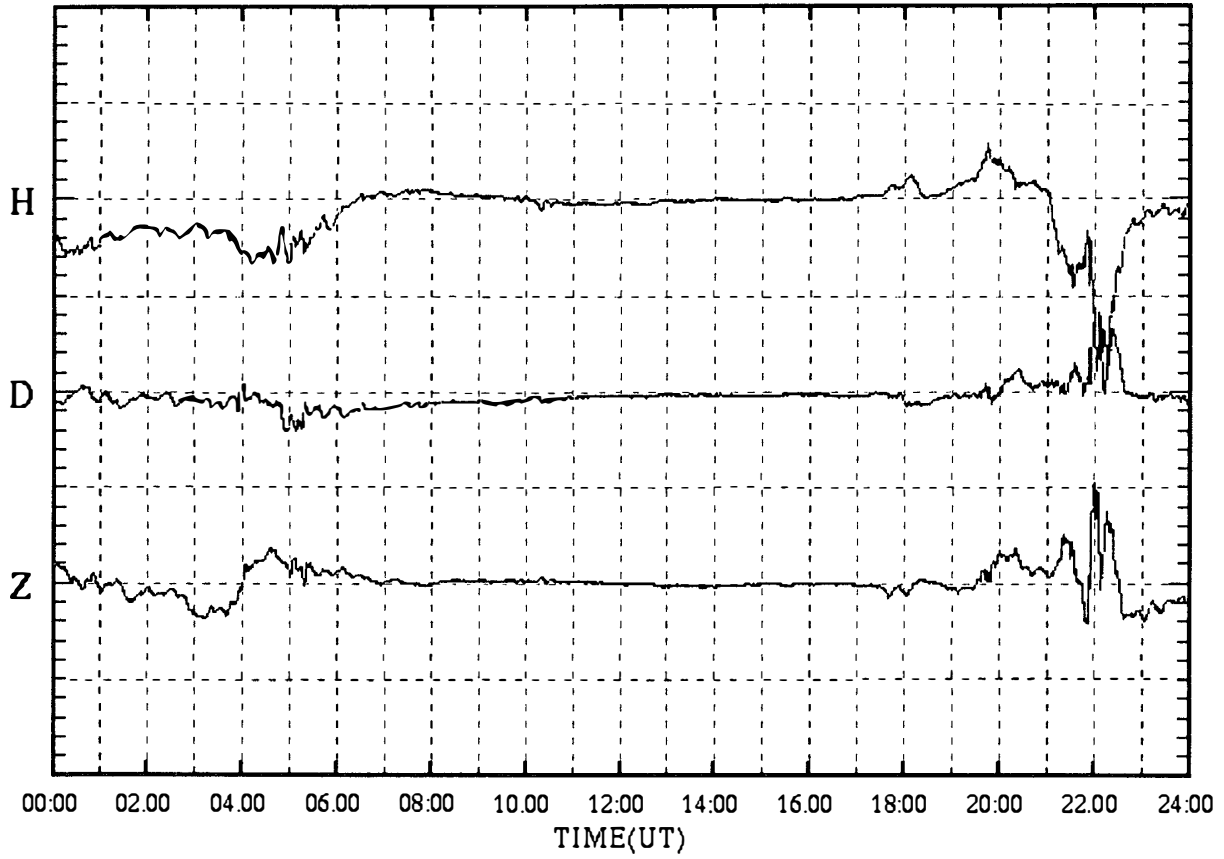

SYOWA magnetogram (100 nT/div)

09 Mar.1999 (DAY:068)

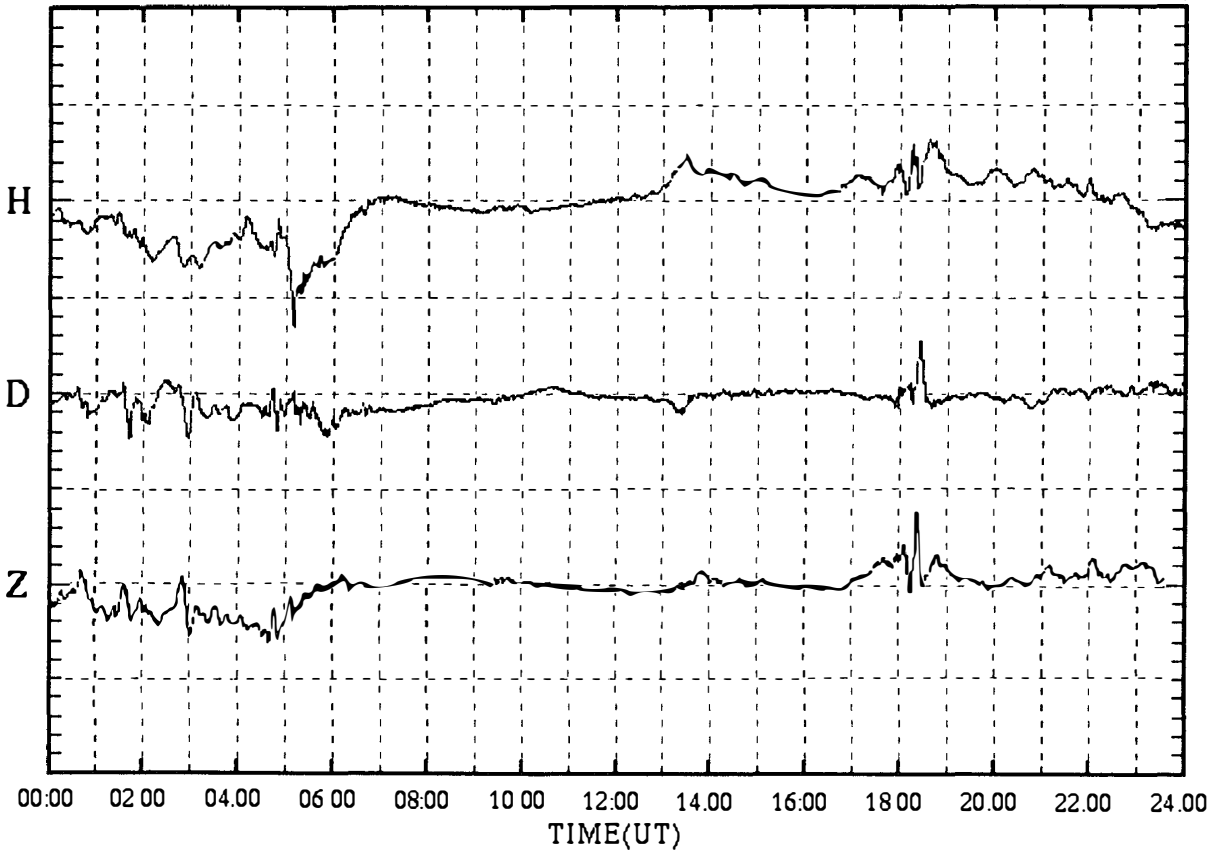

SYOWA magnetogram (100 nT/div)

10 Mar.1999 (DAY:069)

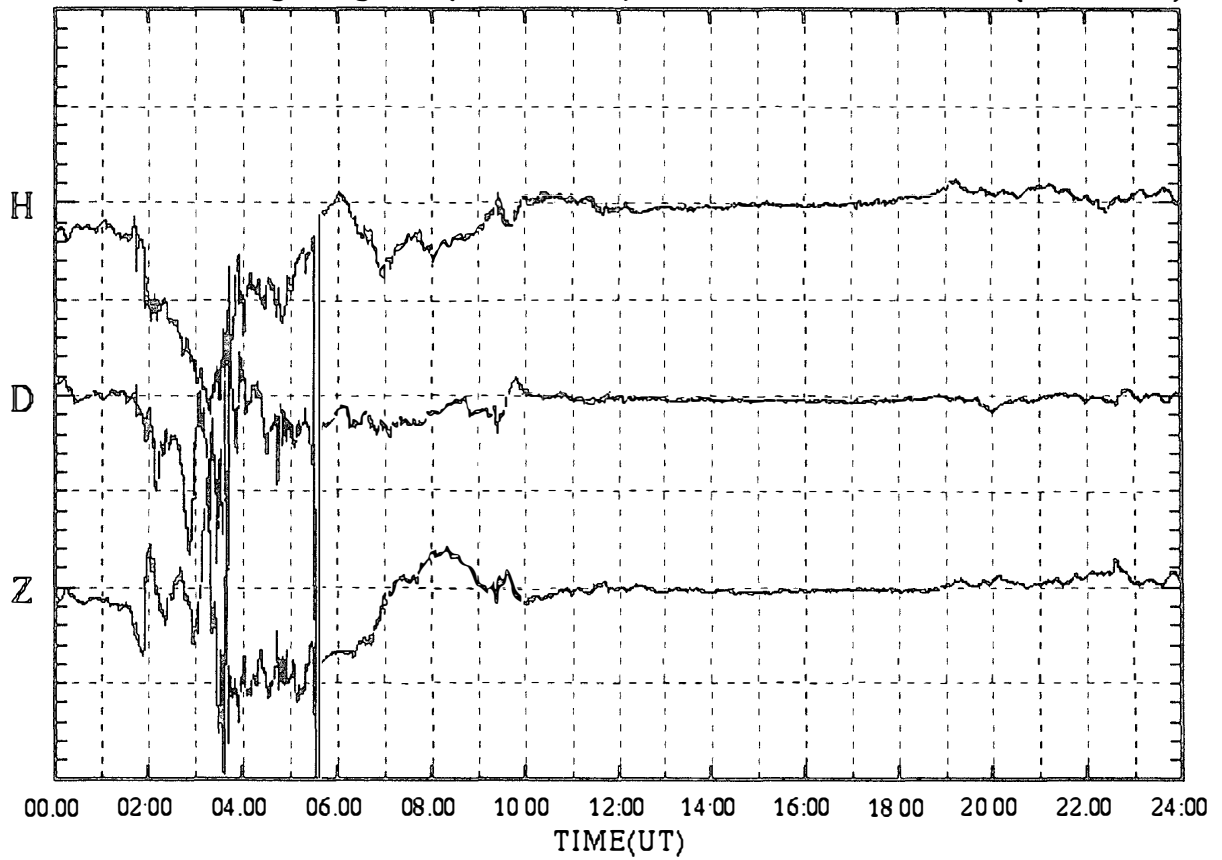

SYOWA magnetogram (100 nT/div)

11 Mar.1999 (DAY:070)

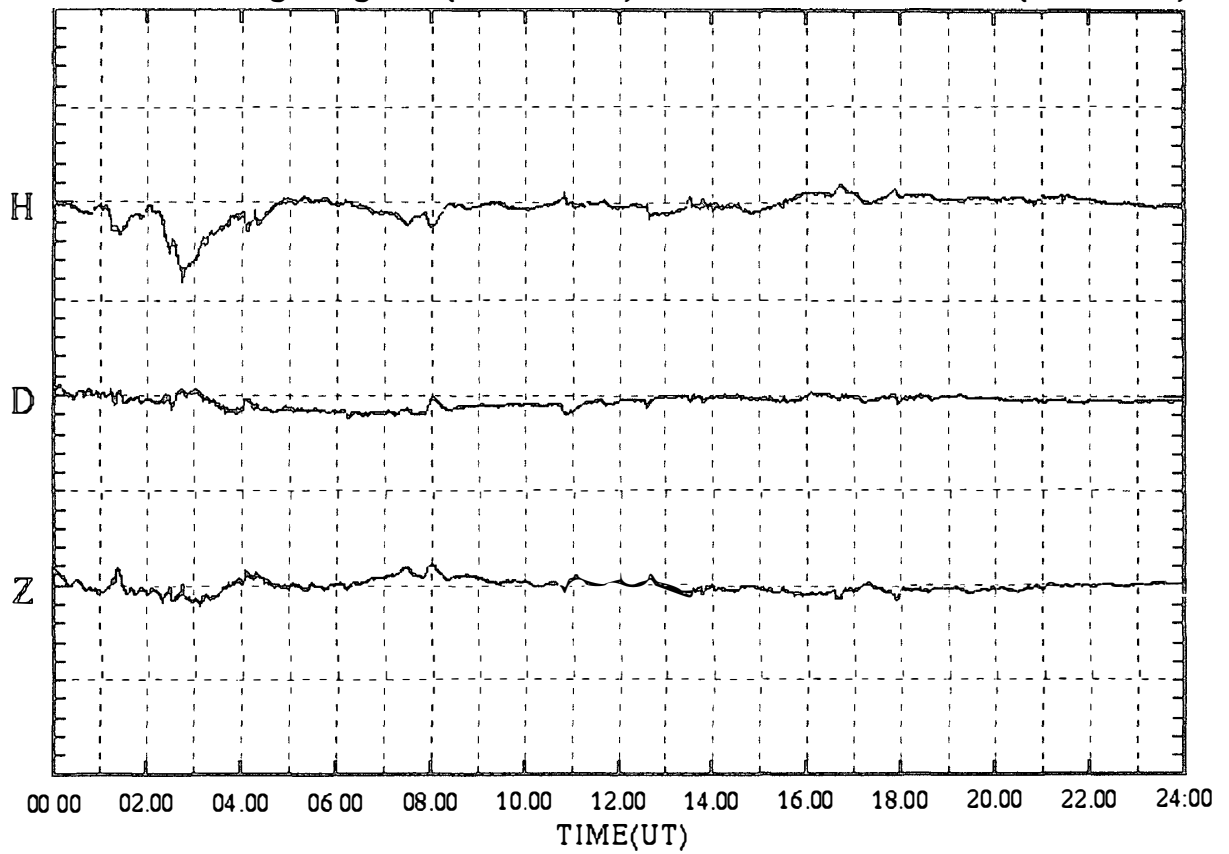

SYOWA magnetogram (100 nT/div)

12 Mar.1999 (DAY:071)

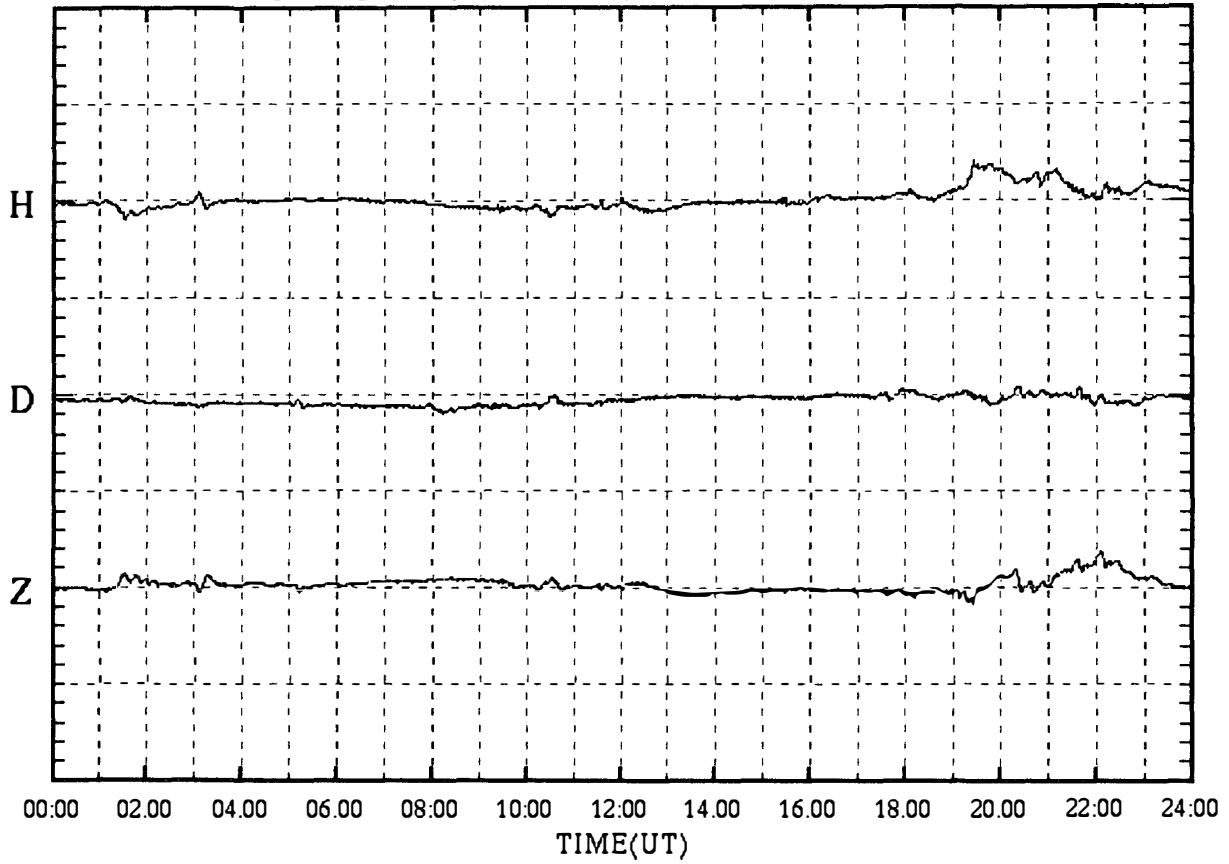

SYOWA magnetogram (100 nT/div)

13 Mar.1999 (DAY:072)

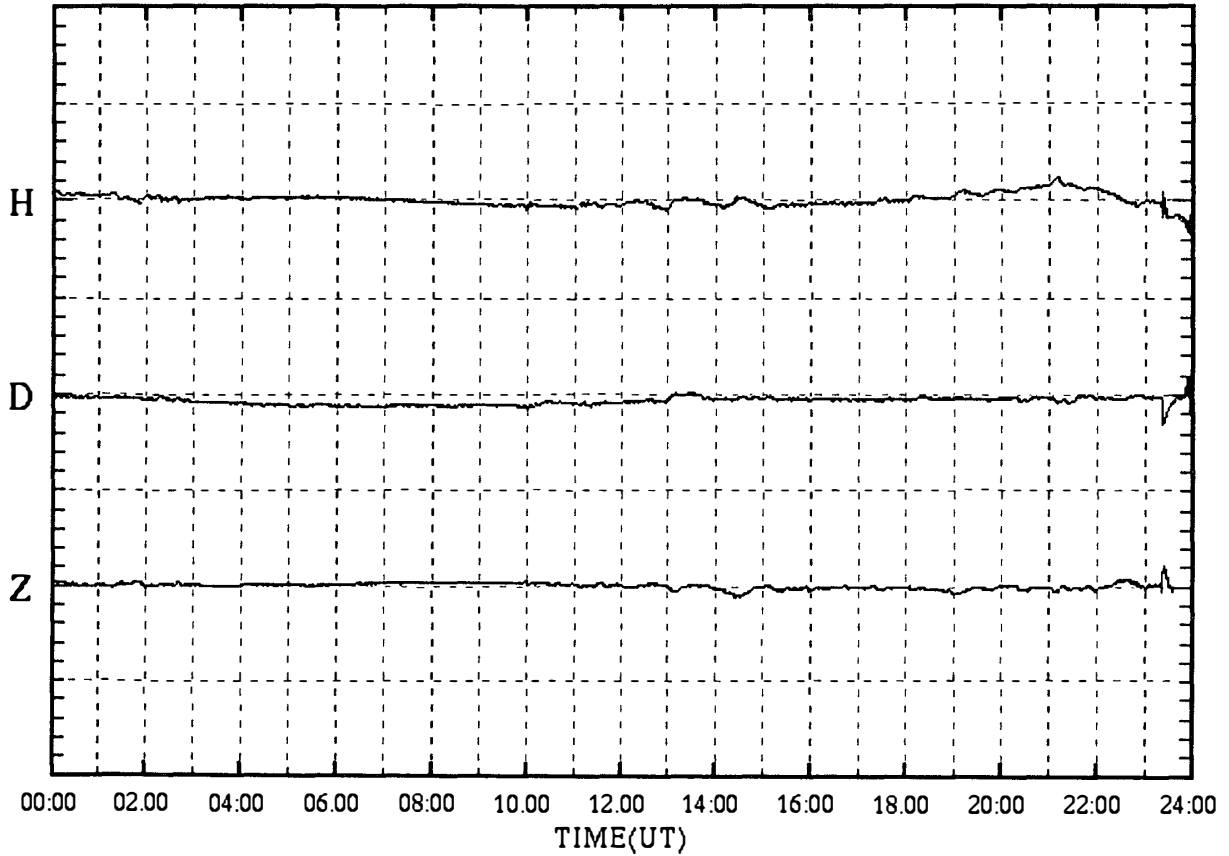

SYOWA magnetogram (100 nT/div)

14 Mar.1999 (DAY:073)

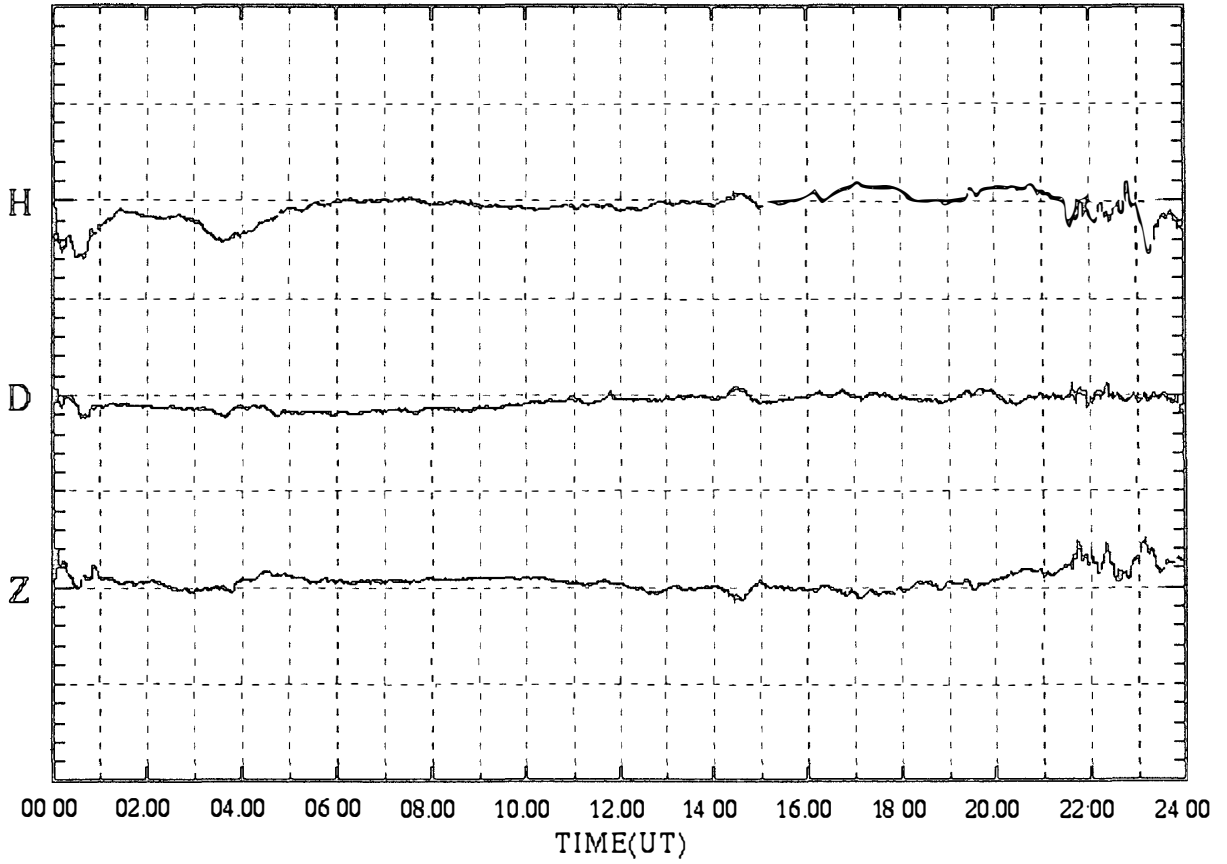

SYOWA magnetogram (100 nT/div)

15 Mar.1999 (DAY:074)

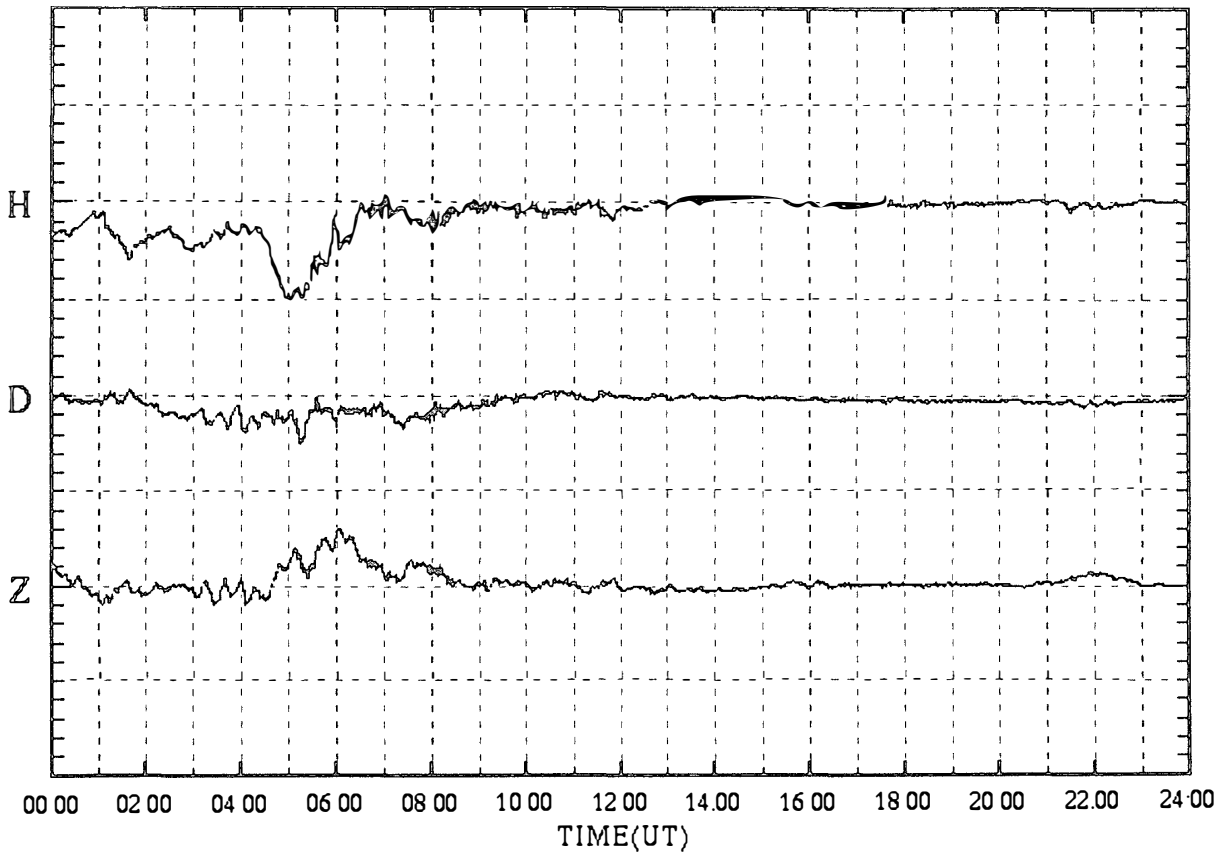

SYOWA magnetogram (100 nT/div)

16 Mar.1999 (DAY:075)

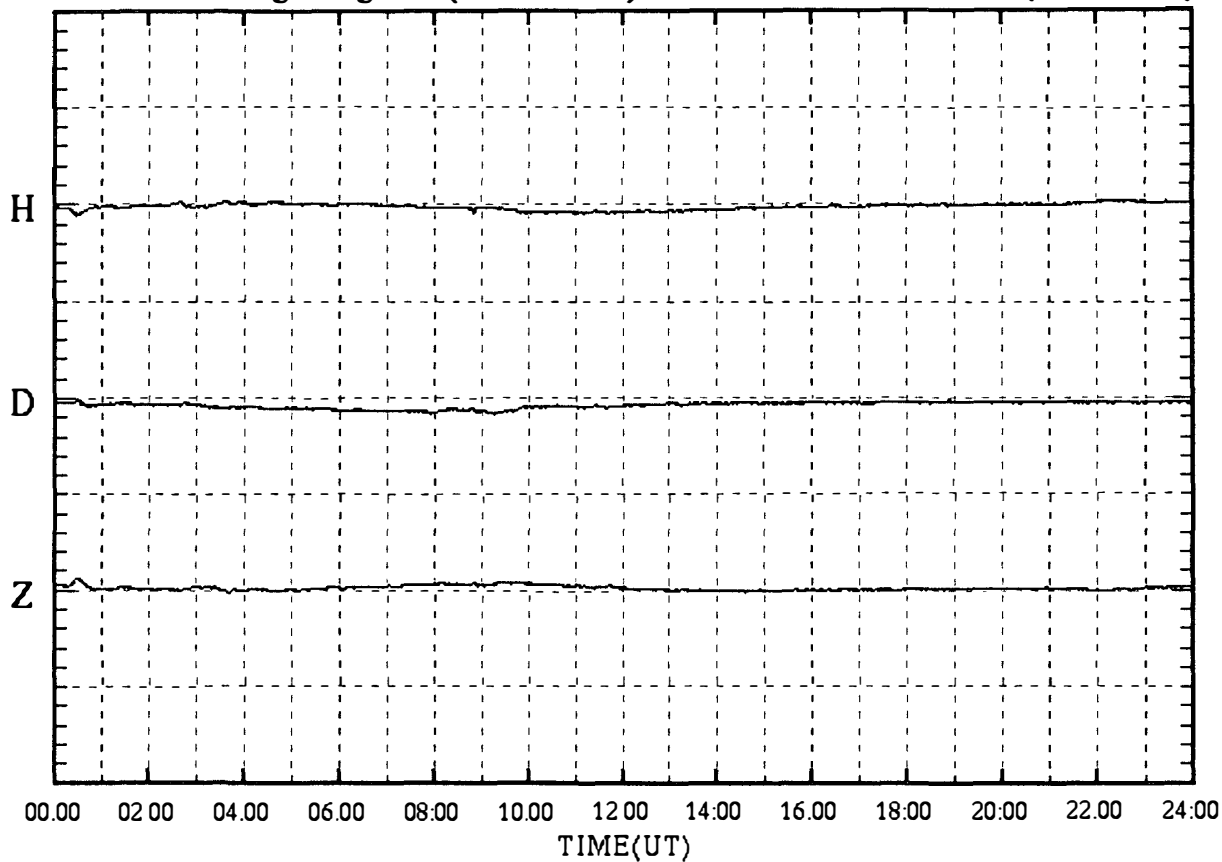

SYOWA magnetogram (100 nT/div)

17 Mar.1999 (DAY:076)

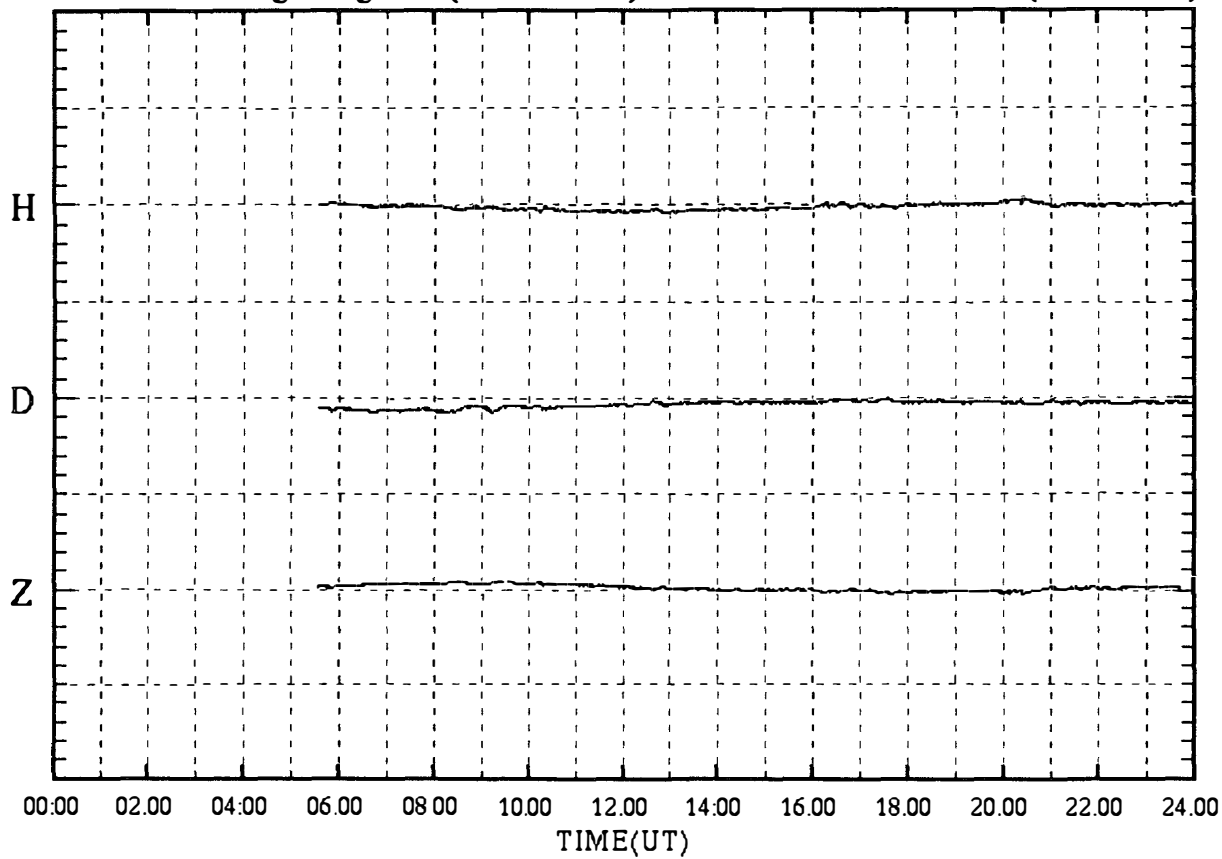

SYOWA magnetogram (100 nT/div)

18 Mar.1999 (DAY:077)

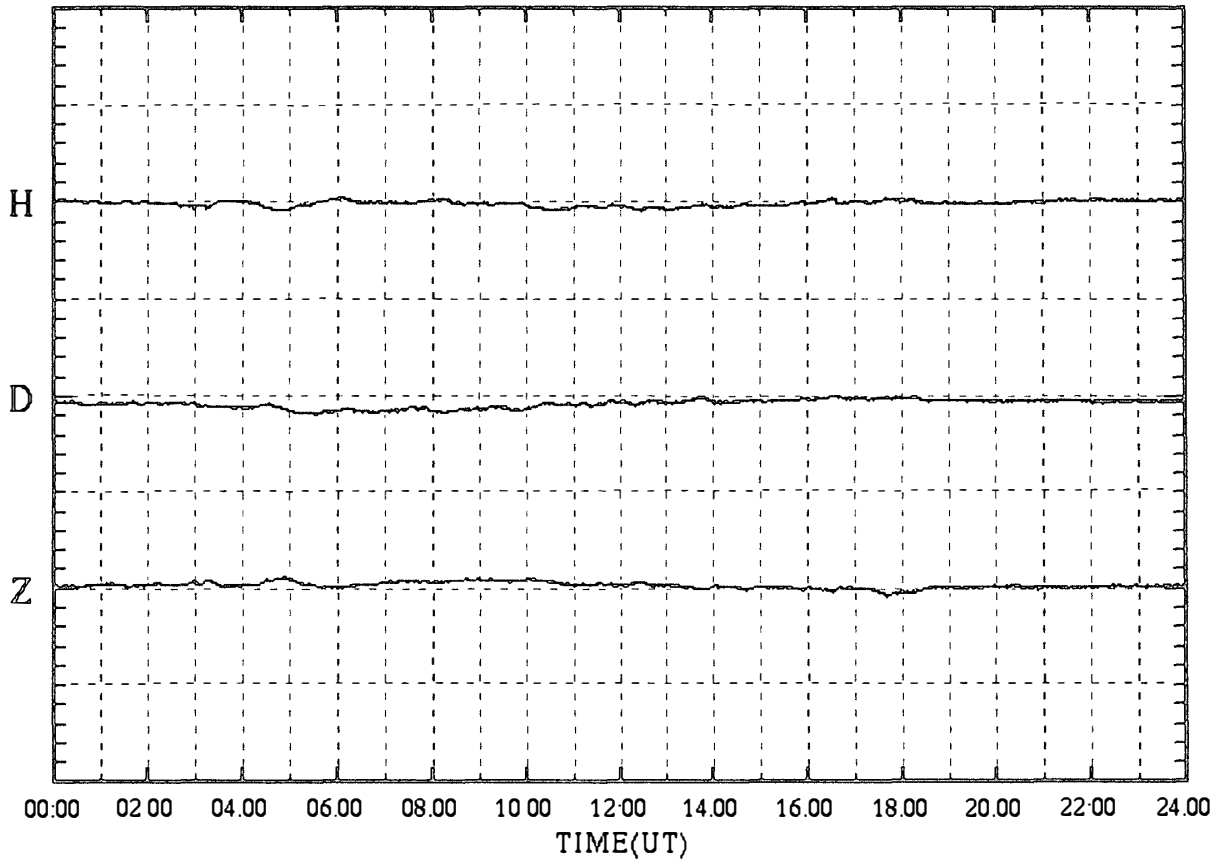

SYOWA magnetogram (100 nT/div)

19 Mar.1999 (DAY:078)

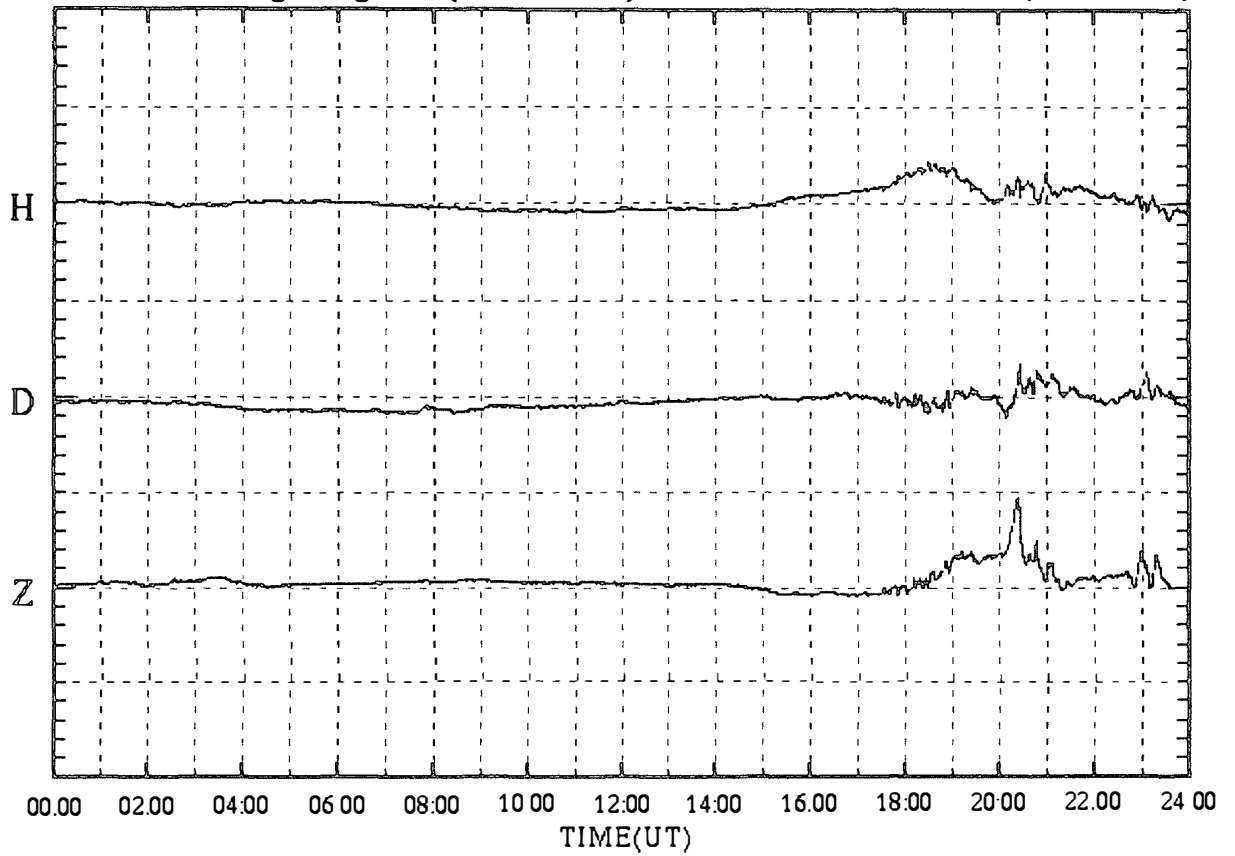

SYOWA magnetogram (100 nT/div)

20 Mar.1999 (DAY:079)

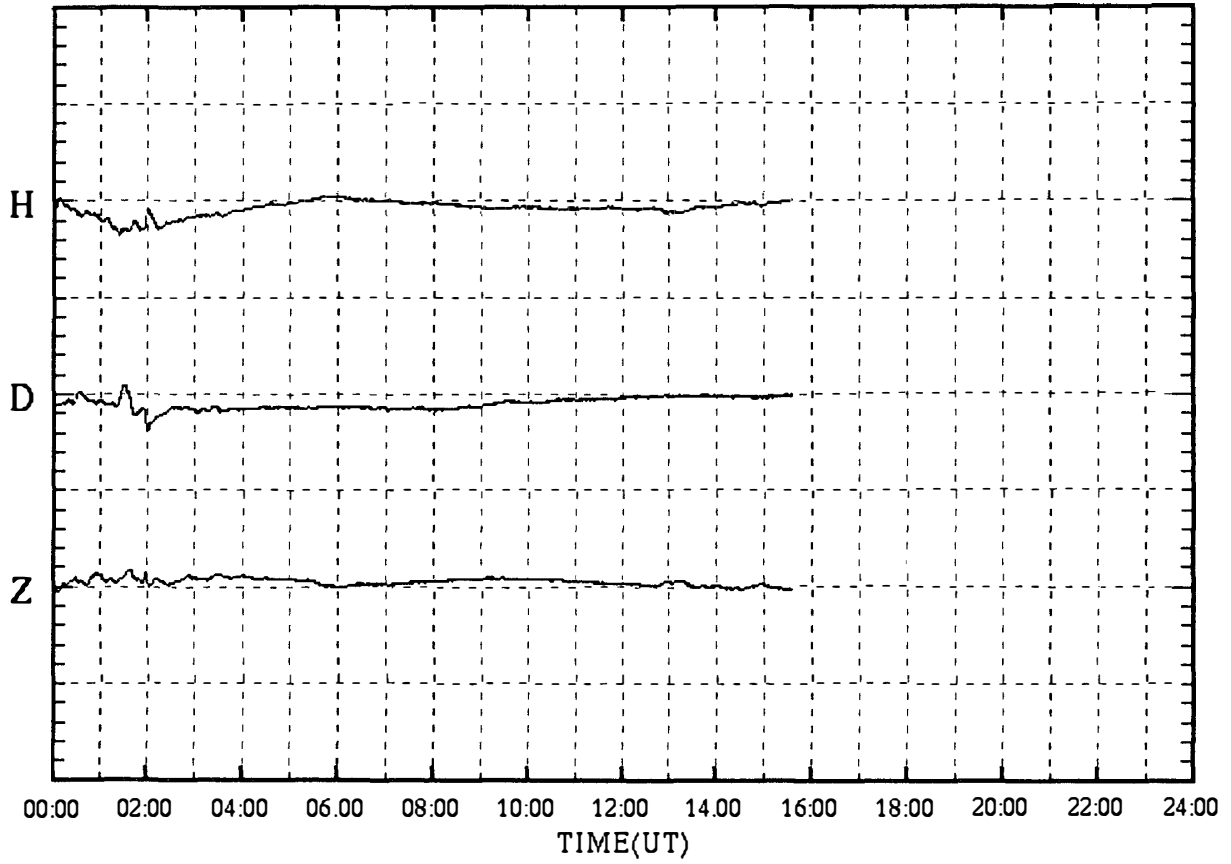

SYOWA magnetogram (100 nT/div)

21 Mar.1999 (DAY:080)

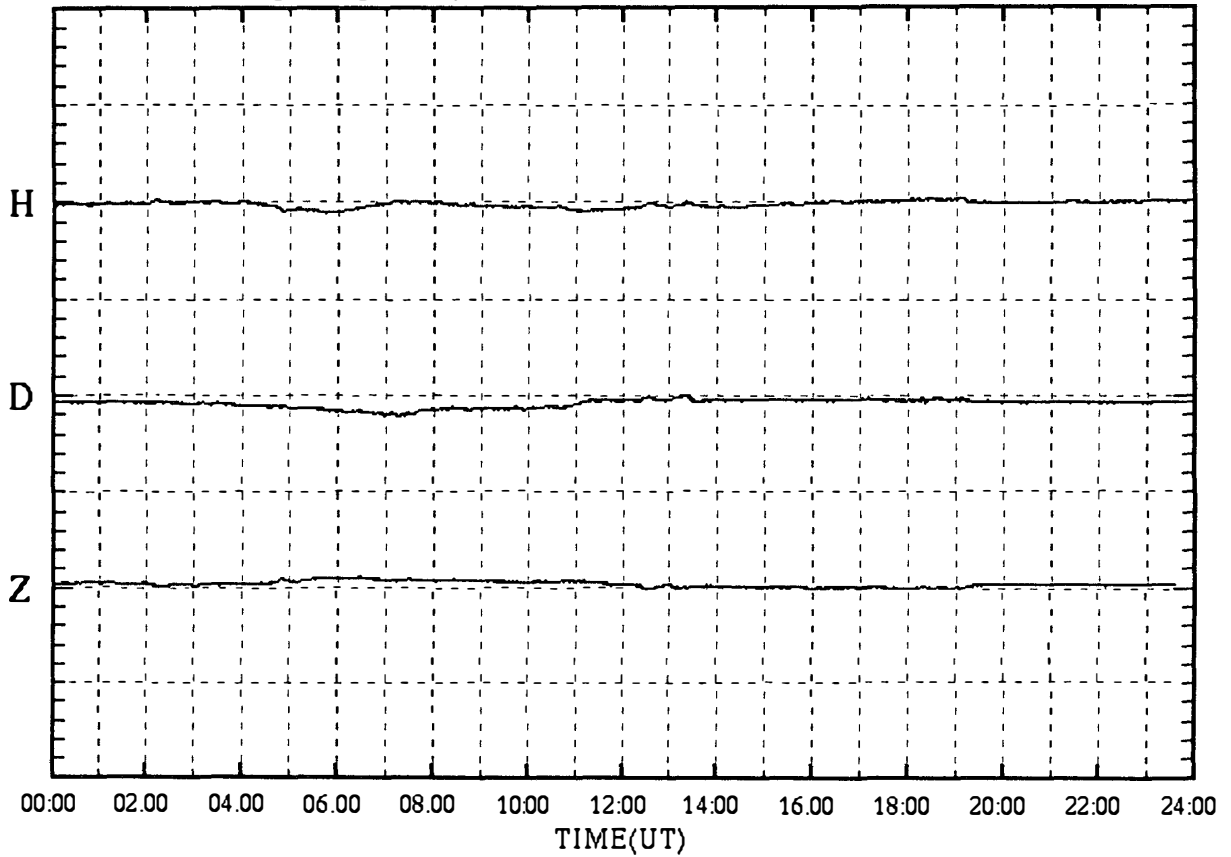



SYOWA magnetogram (100 nT/div)

22 Mar.1999 (DAY:081)

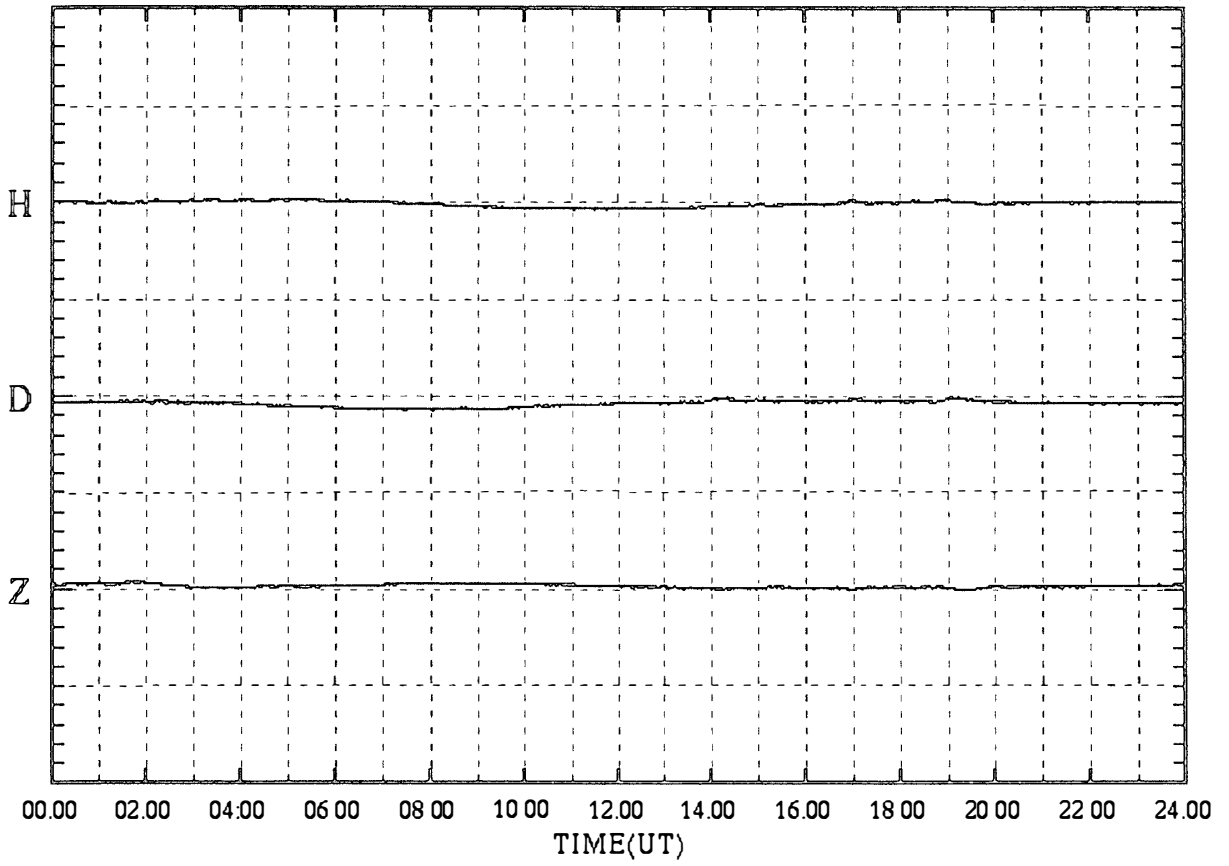

SYOWA magnetogram (100 nT/div)

23 Mar.1999 (DAY:082)

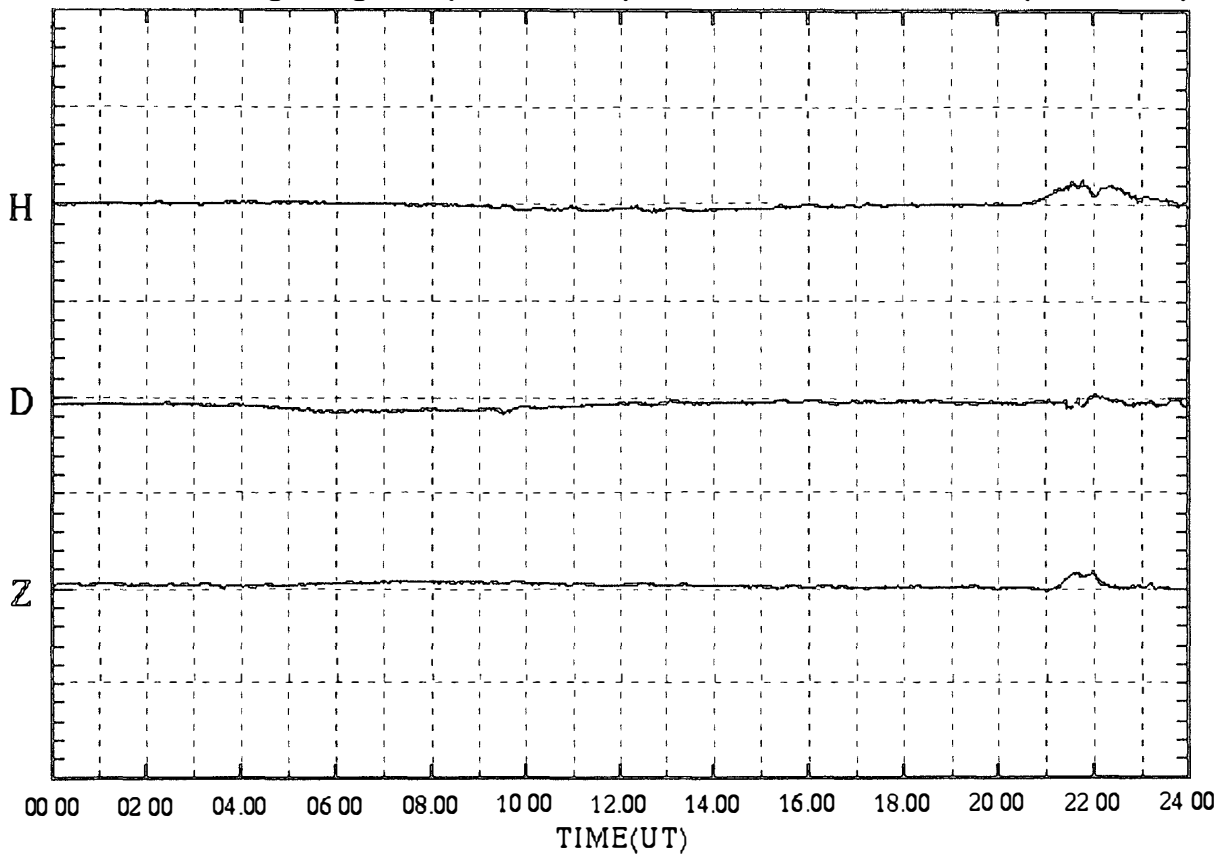

SYOWA magnetogram (100 nT/div)

24 Mar.1999 (DAY:083)

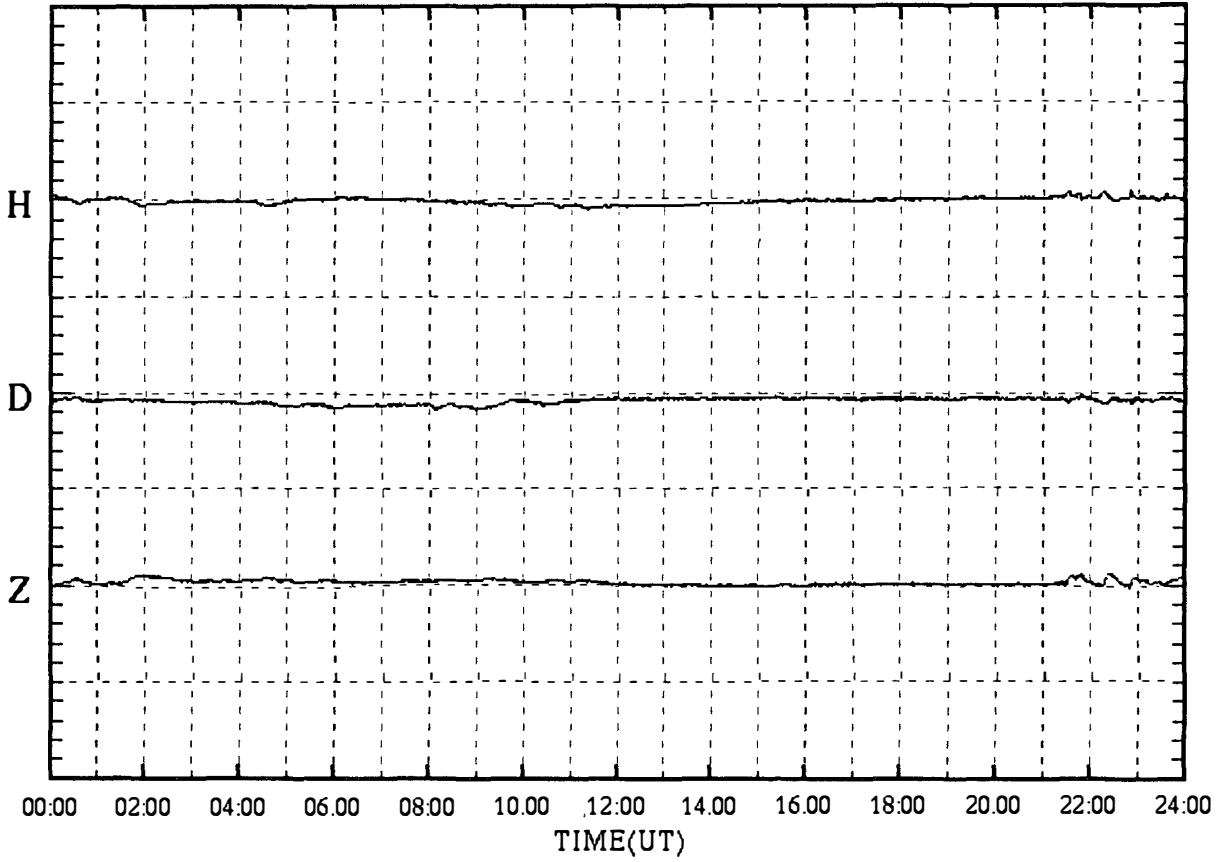

SYOWA magnetogram (100 nT/div)

25 Mar.1999 (DAY:084)

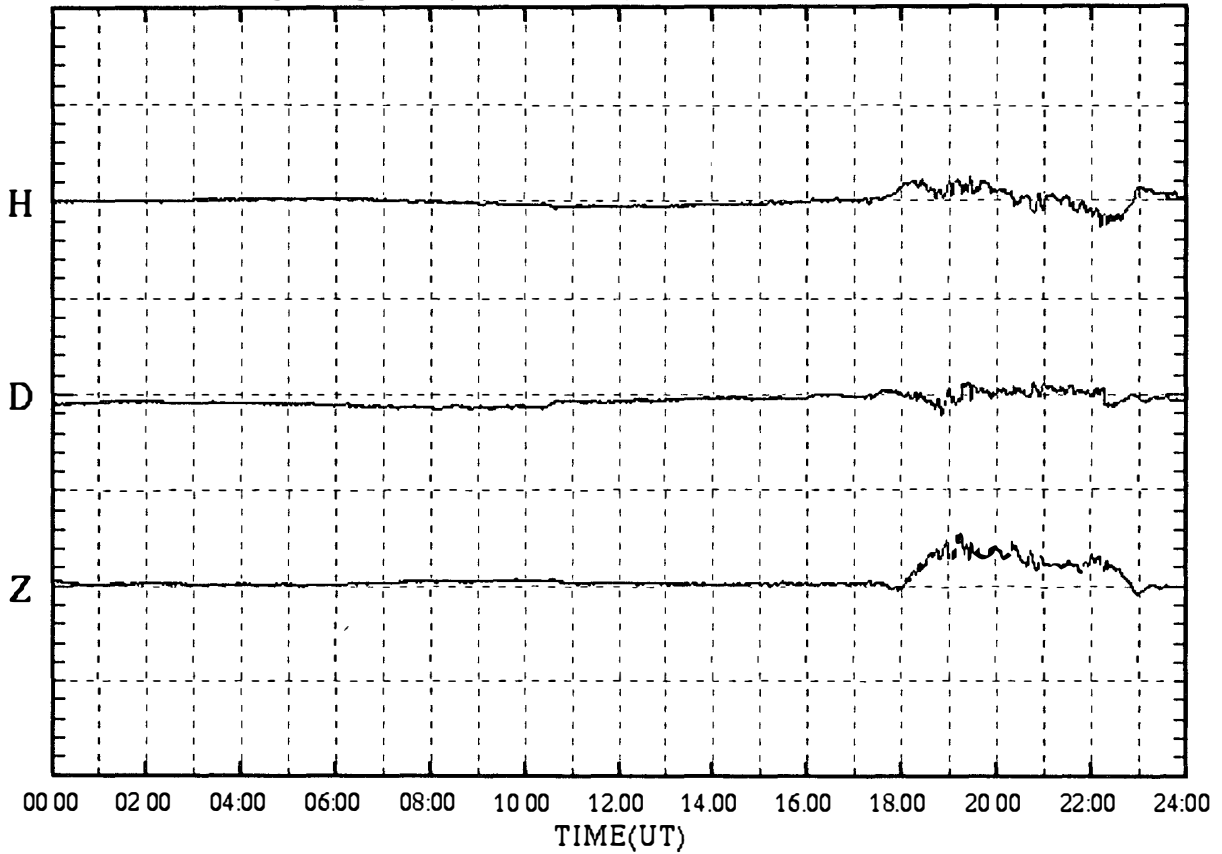

SYOWA magnetogram (100 nT/div)

26 Mar.1999 (DAY:085)

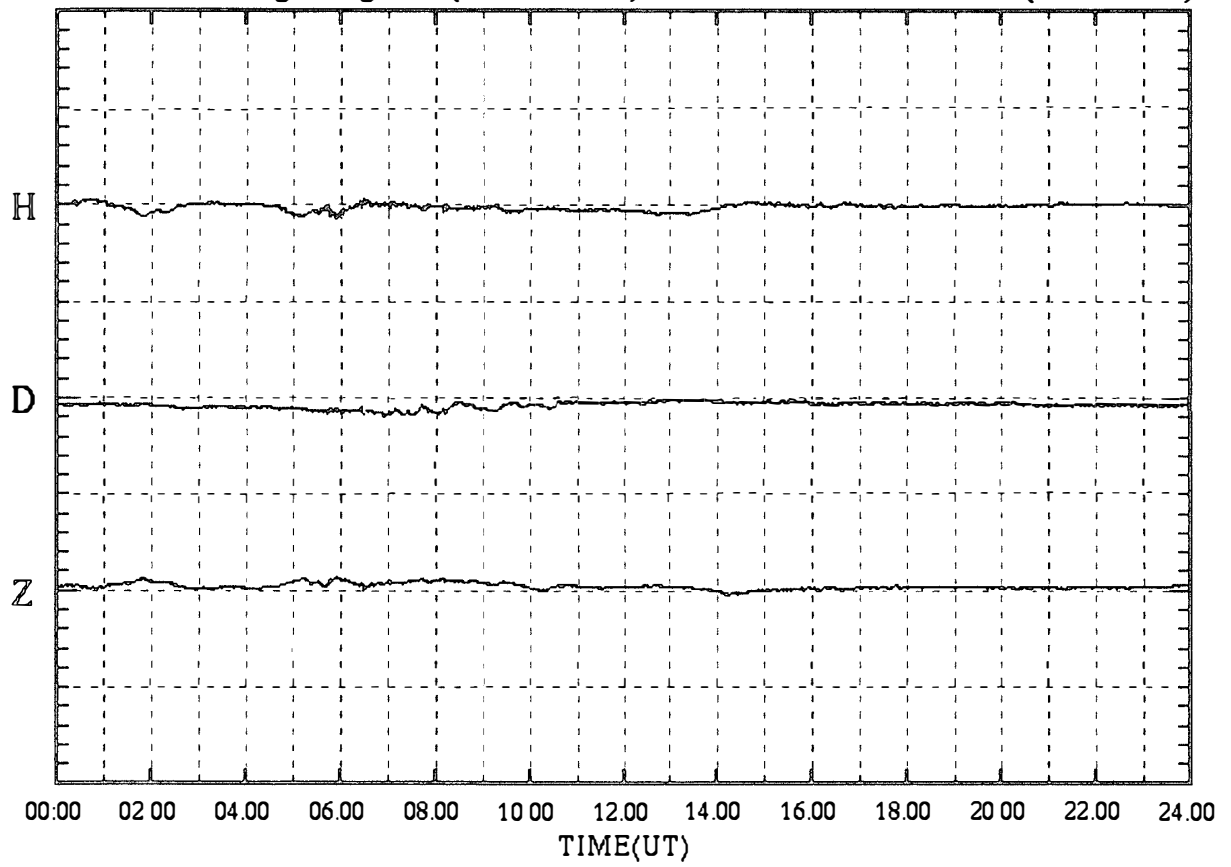

SYOWA magnetogram (100 nT/div)

27 Mar.1999 (DAY:086)

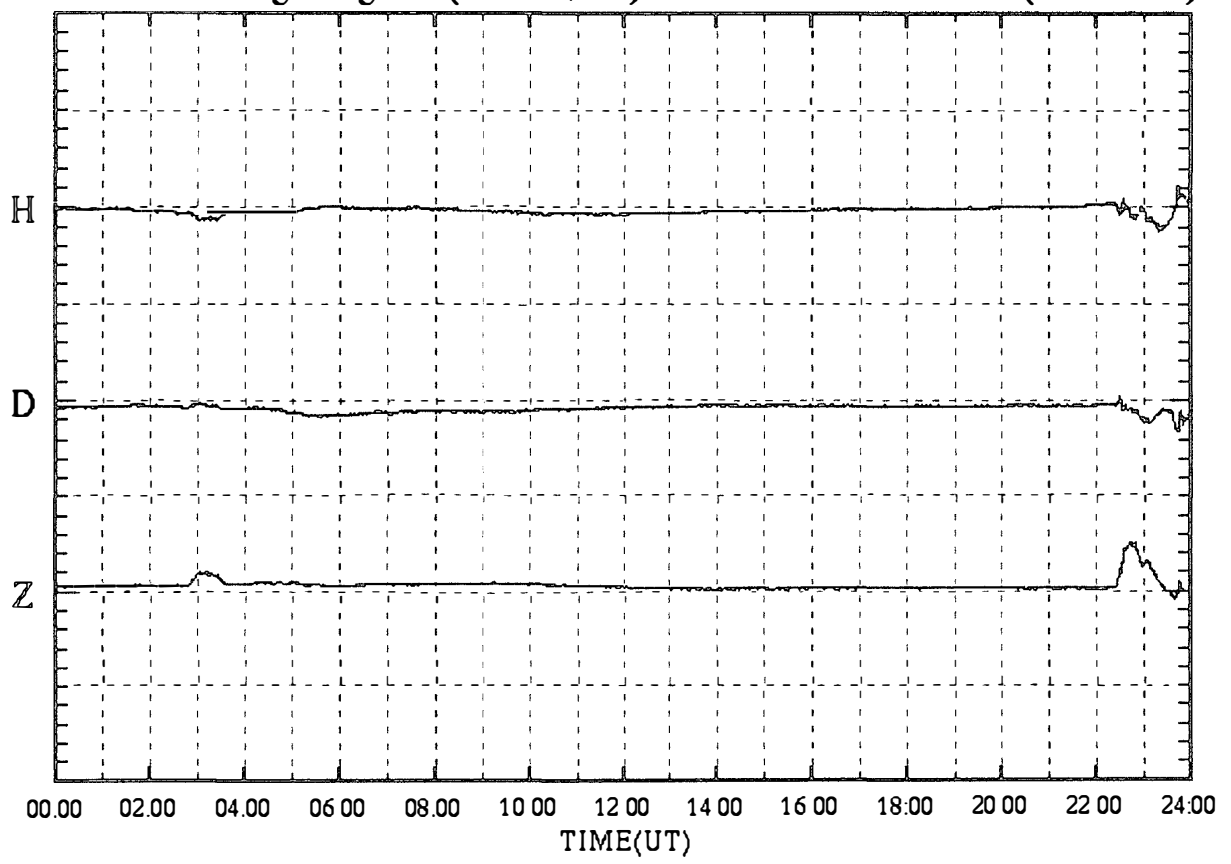

SYOWA magnetogram (100 nT/div)

28 Mar.1999 (DAY:087)

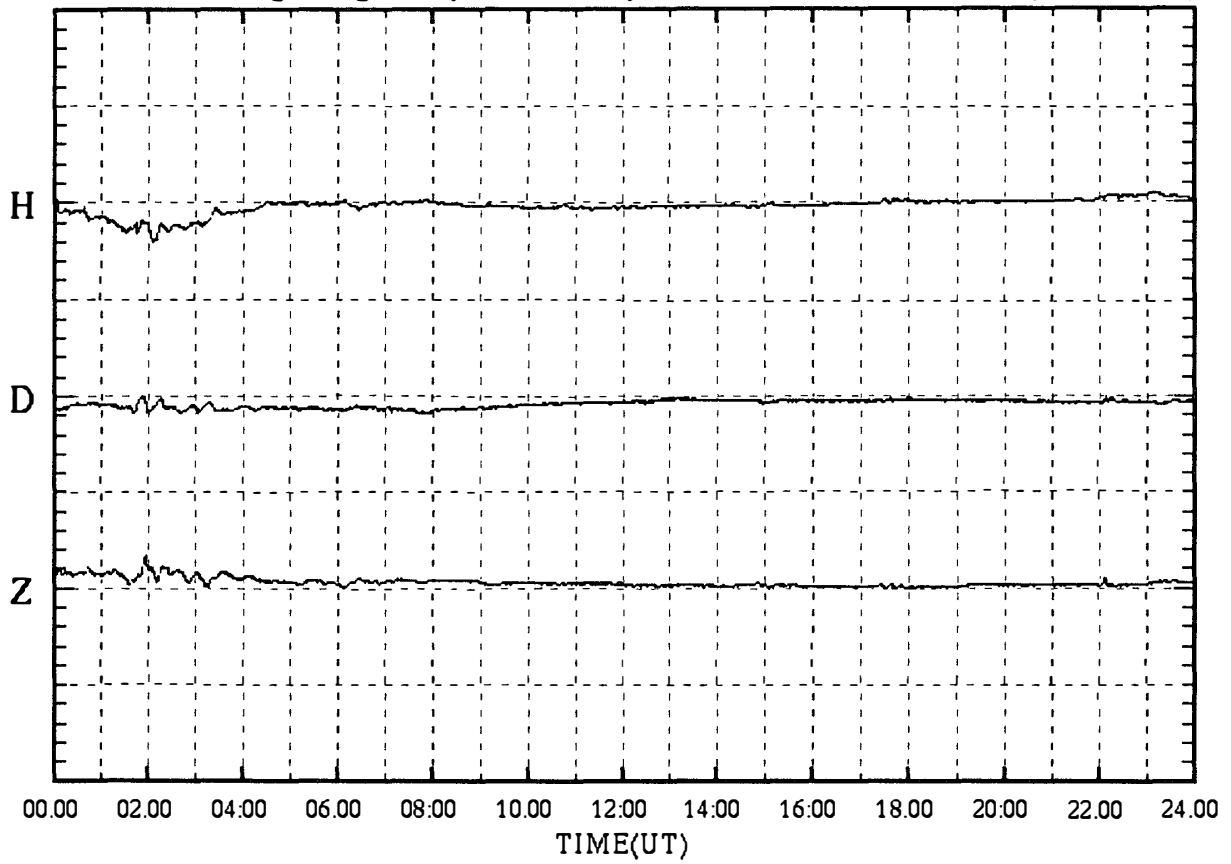

SYOWA magnetogram (100 nT/div)

29 Mar.1999 (DAY:088)

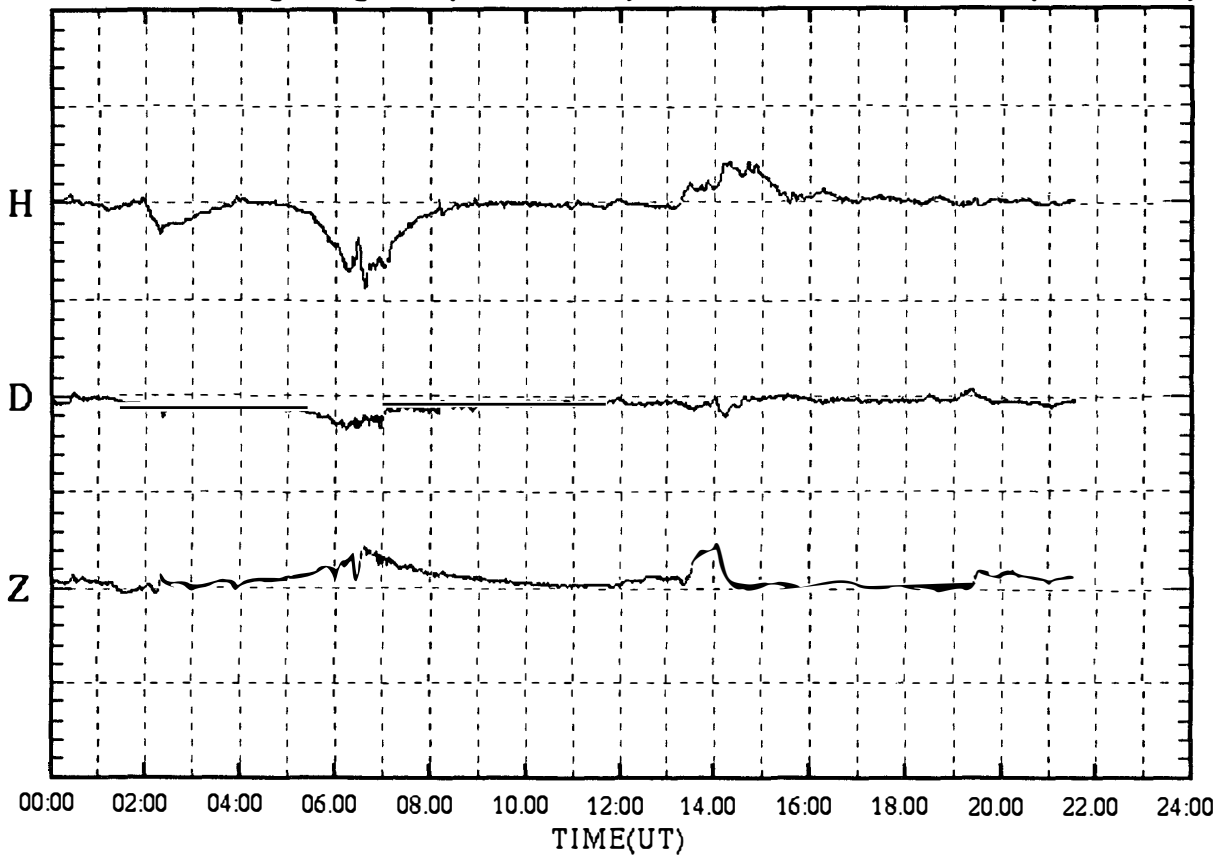

SYOWA magnetogram (100 nT/div)

30 Mar.1999 (DAY:089)

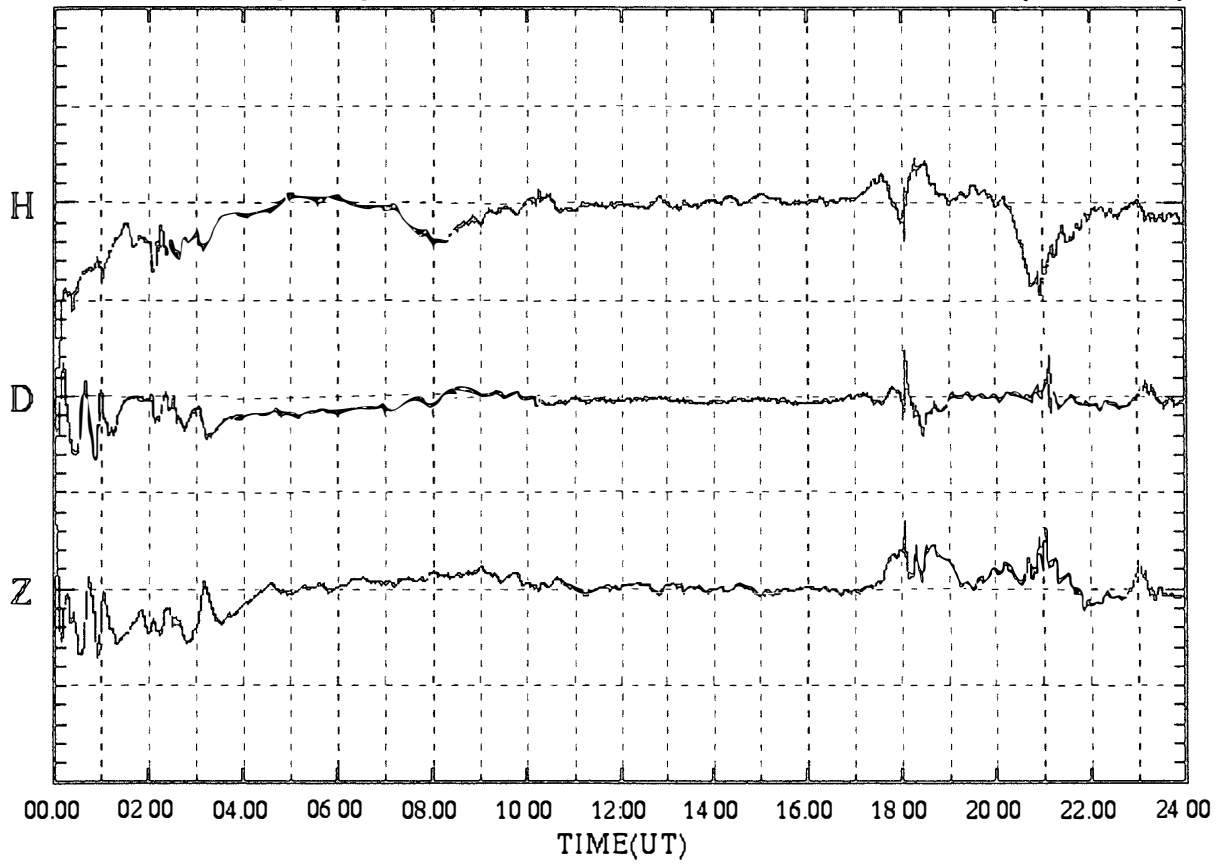

SYOWA magnetogram (100 nT/div)

31 Mar.1999 (DAY:090)

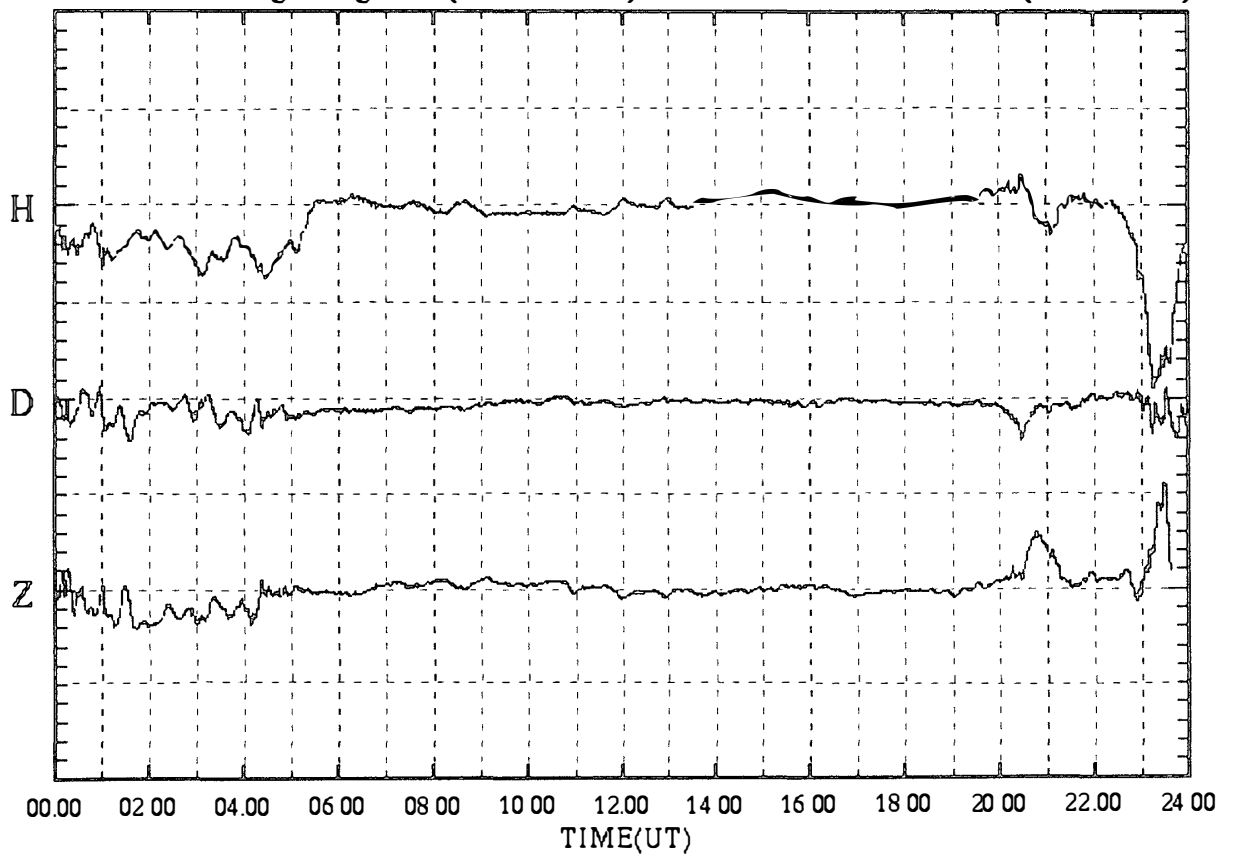

SYOWA magnetogram (100 nT/div)

01 Apr.1999 (DAY:091)

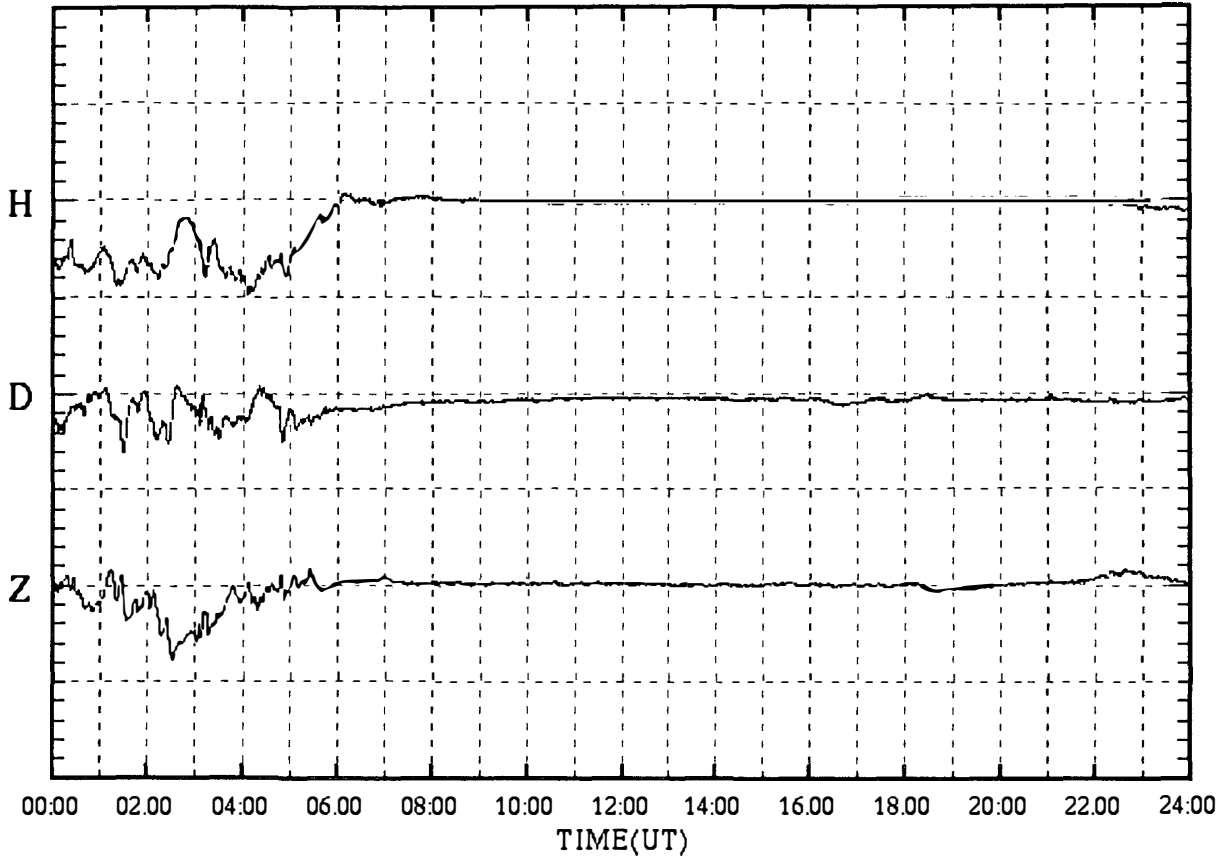

SYOWA magnetogram (100 nT/div)

02 Apr.1999 (DAY:092)

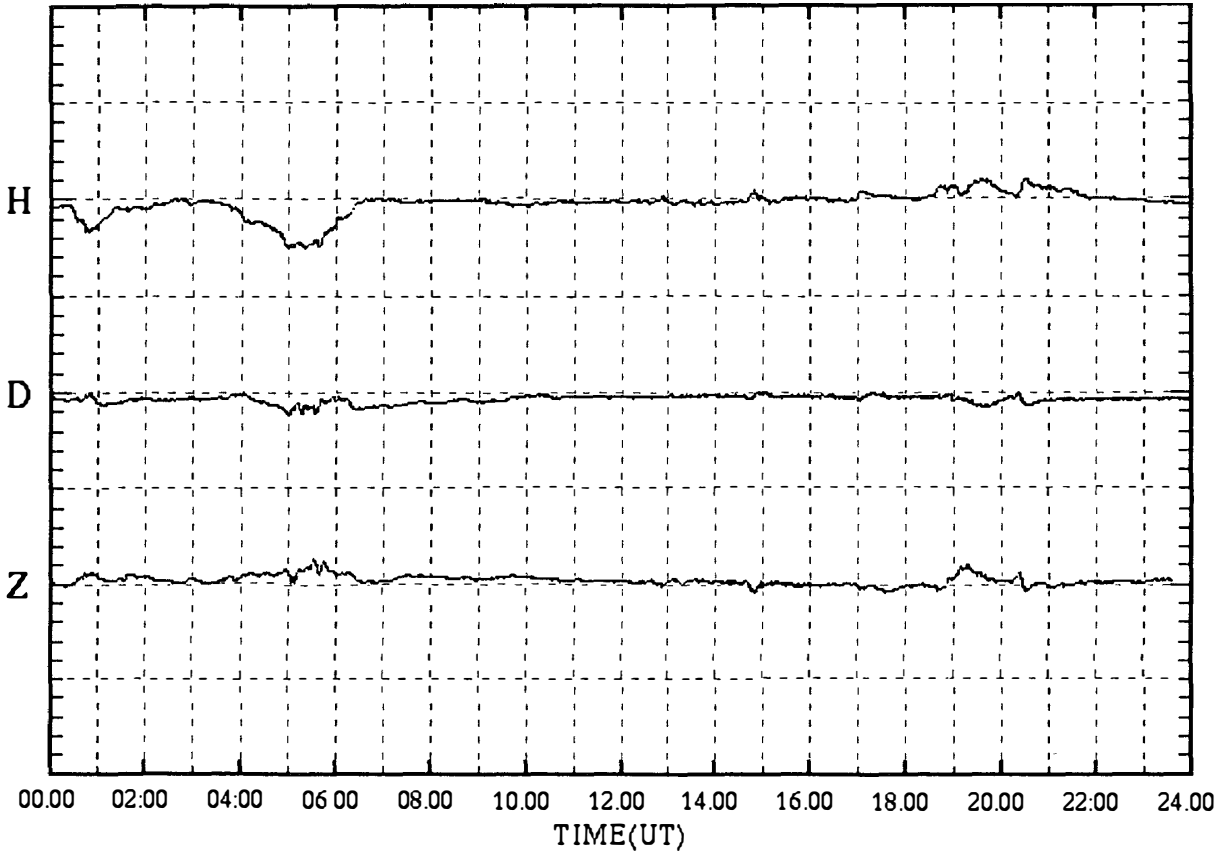

SYOWA magnetogram (100 nT/div)

03 Apr.1999 (DAY:093)

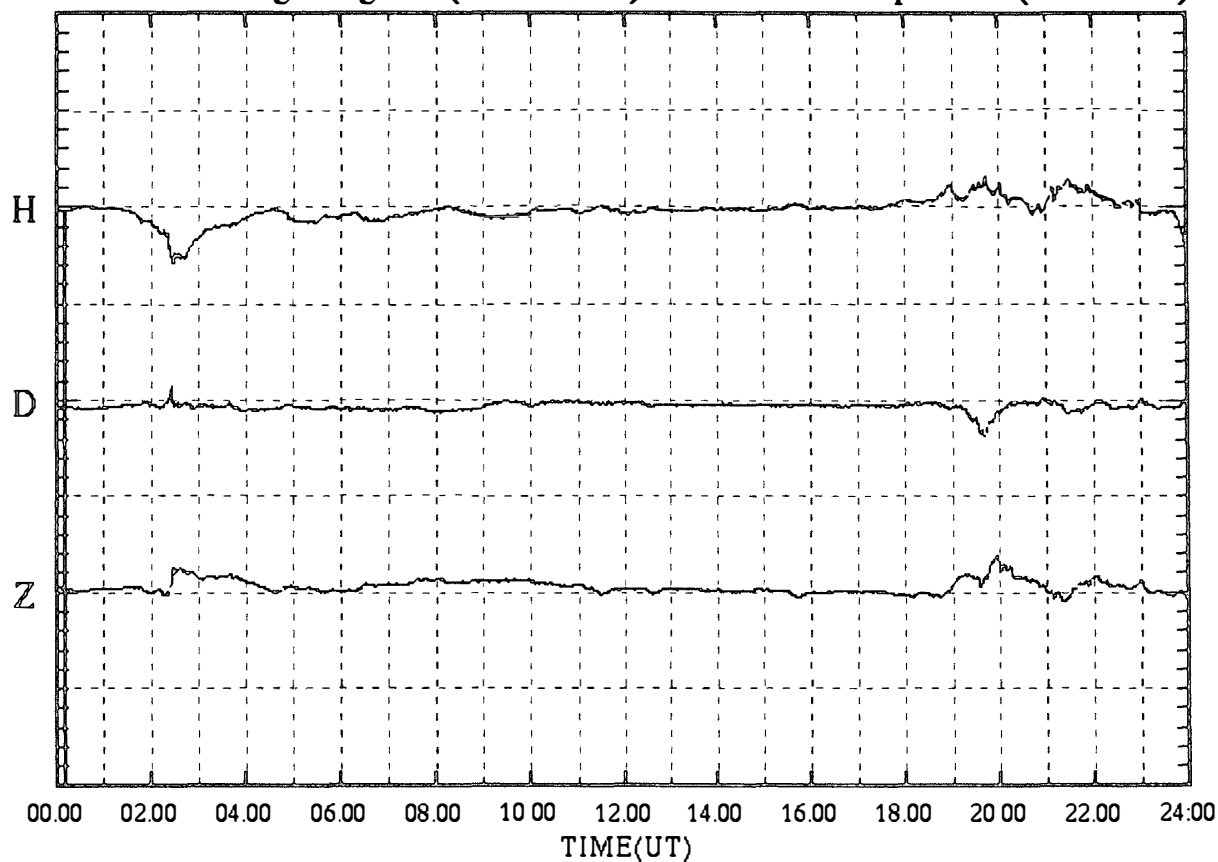

SYOWA magnetogram (100 nT/div)

04 Apr.1999 (DAY:094)

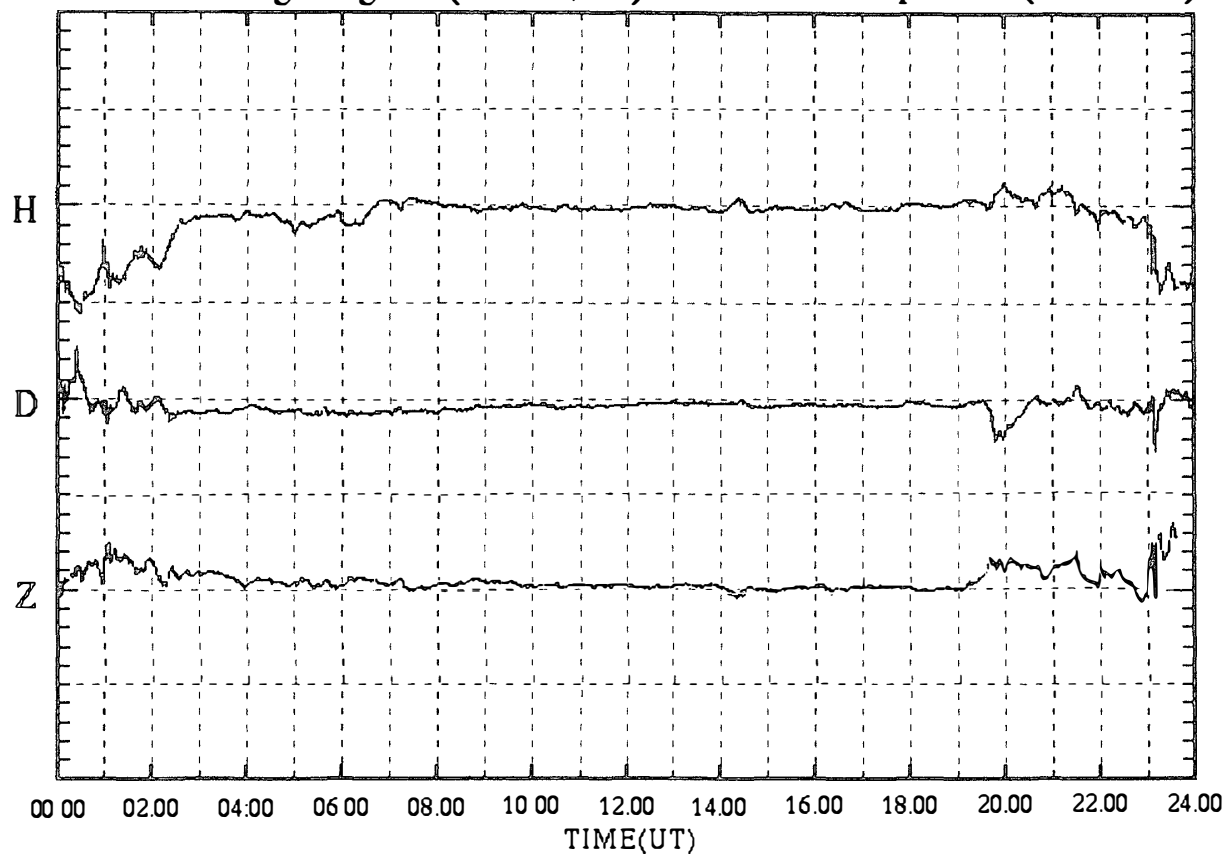

SYOWA magnetogram (100 nT/div)

05 Apr.1999 (DAY:095)

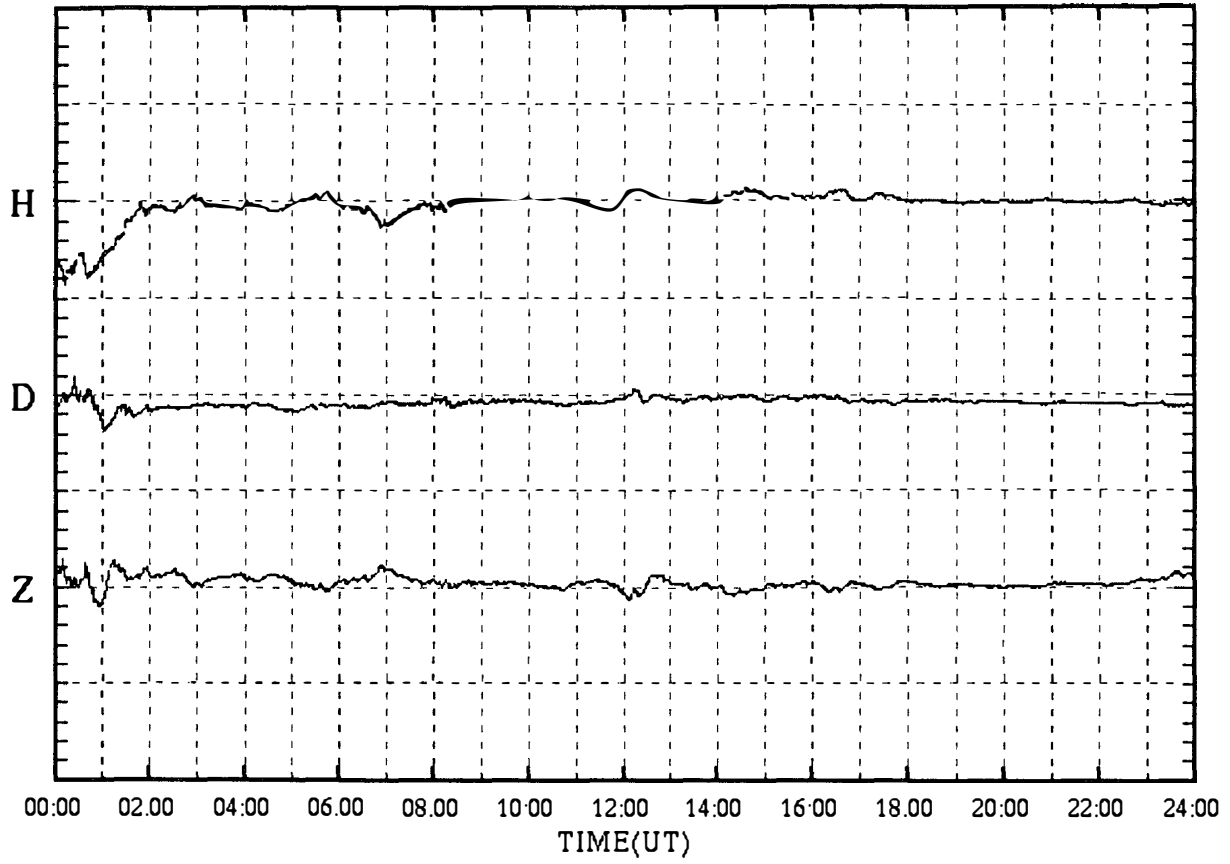

SYOWA magnetogram (100 nT/div)

06 Apr.1999 (DAY:096)

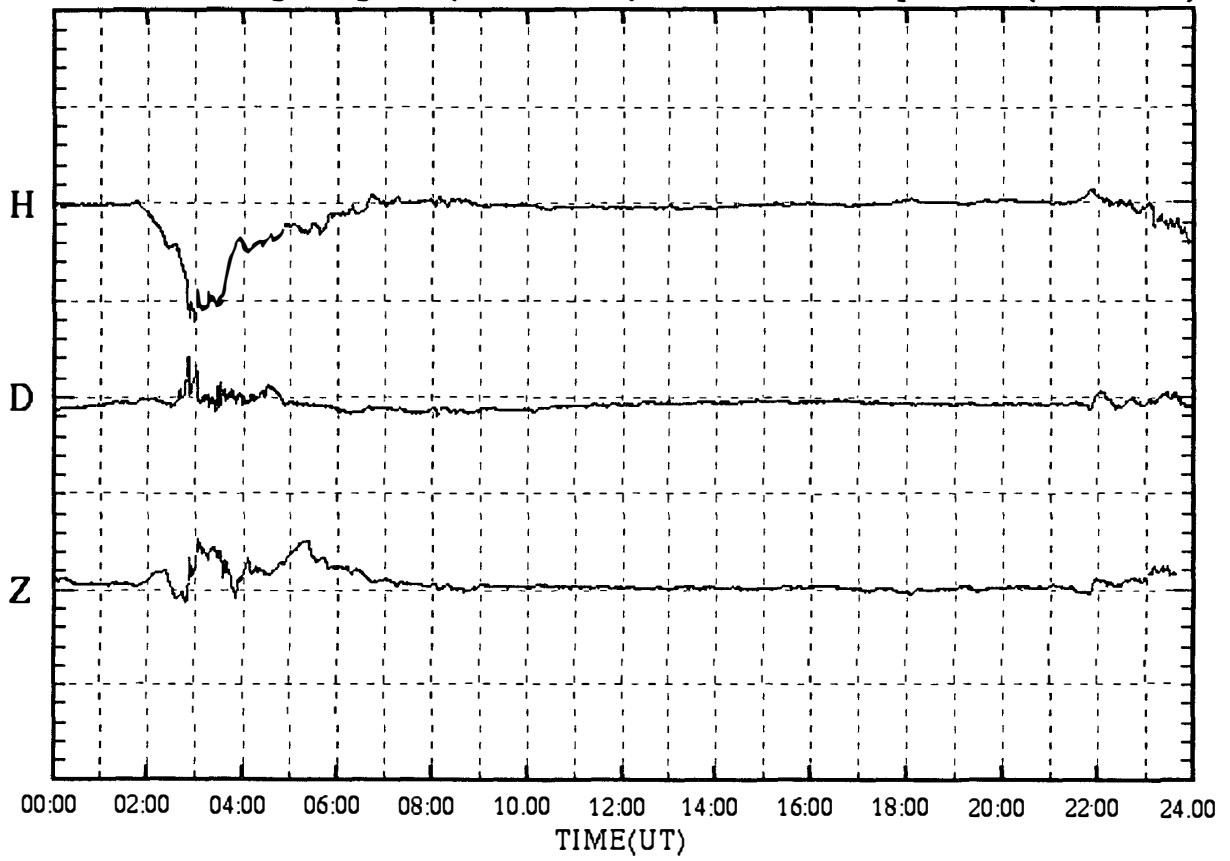



SYOWA magnetogram (100 nT/div)

07 Apr.1999 (DAY:097)

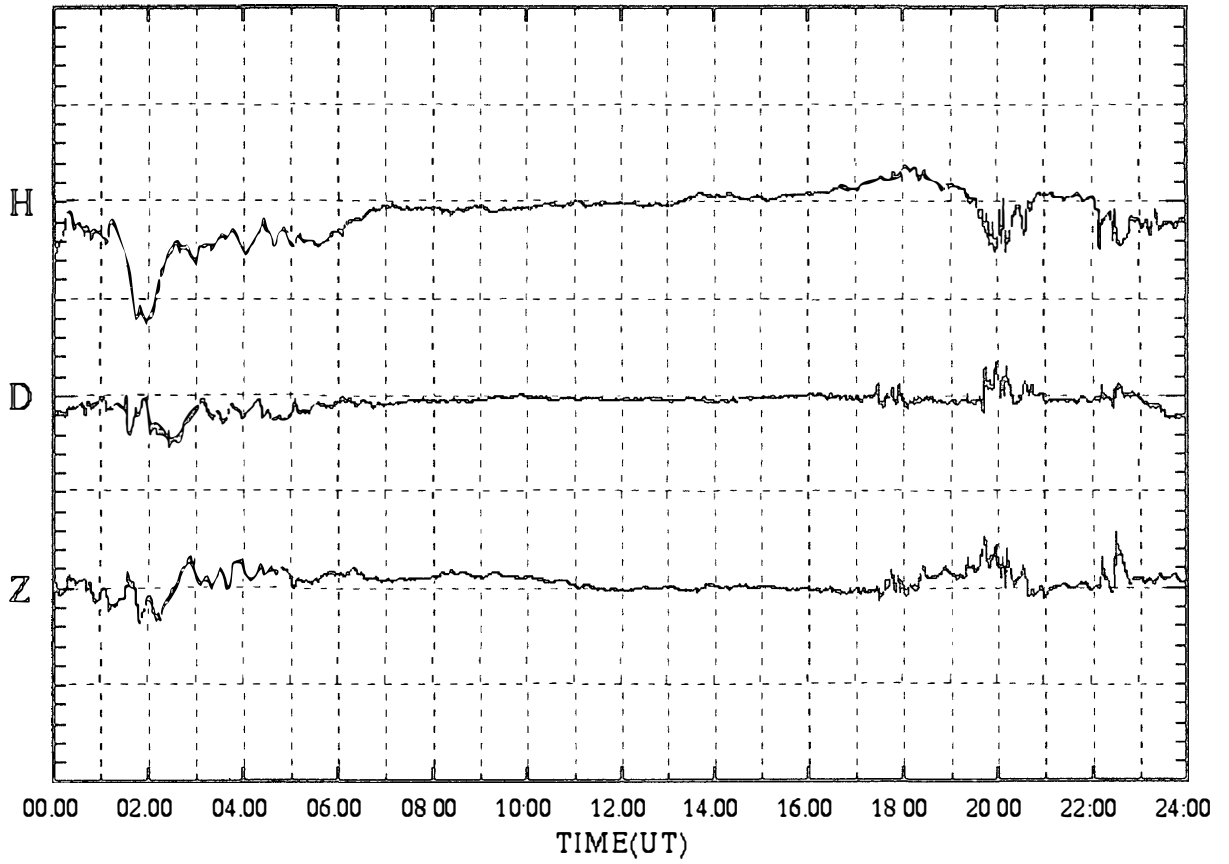

SYOWA magnetogram (100 nT/div)

08 Apr.1999 (DAY:098)

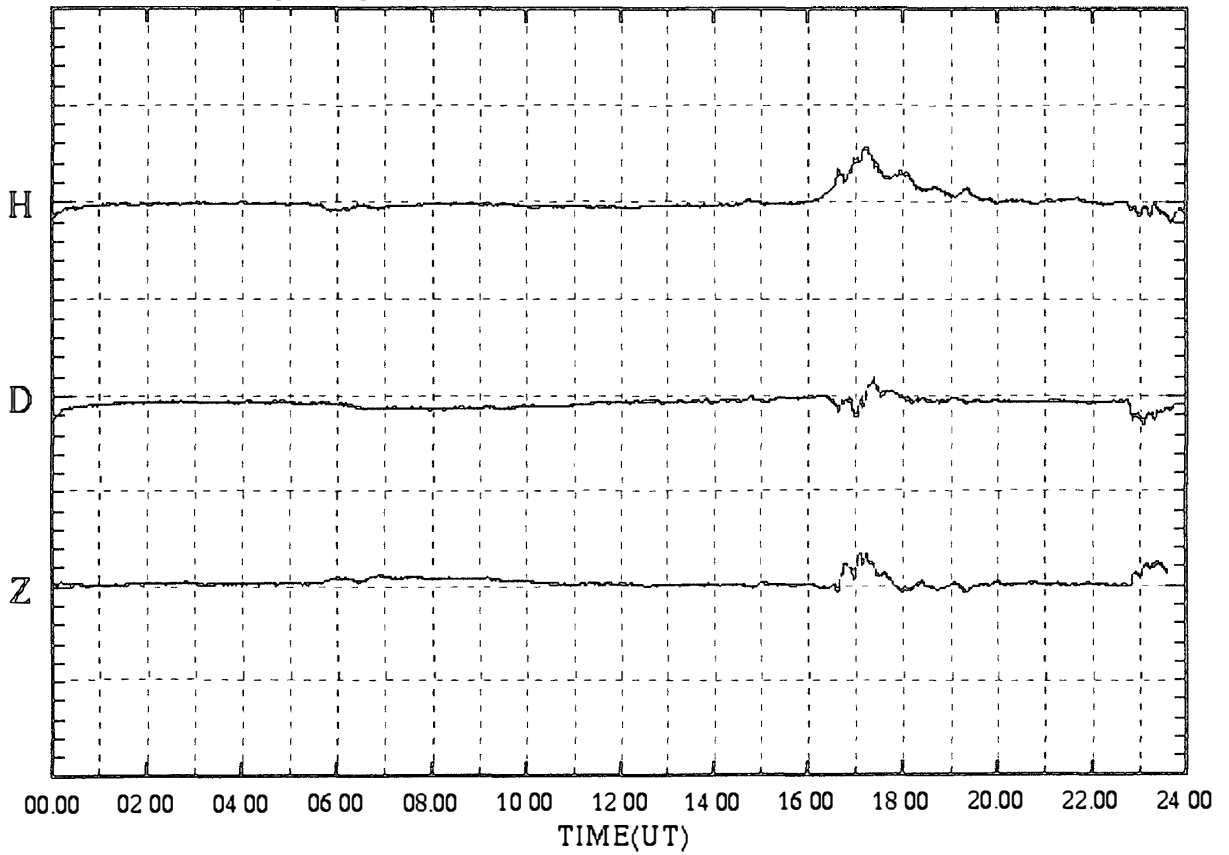

SYOWA magnetogram (100 nT/div)

09 Apr.1999 (DAY:099)

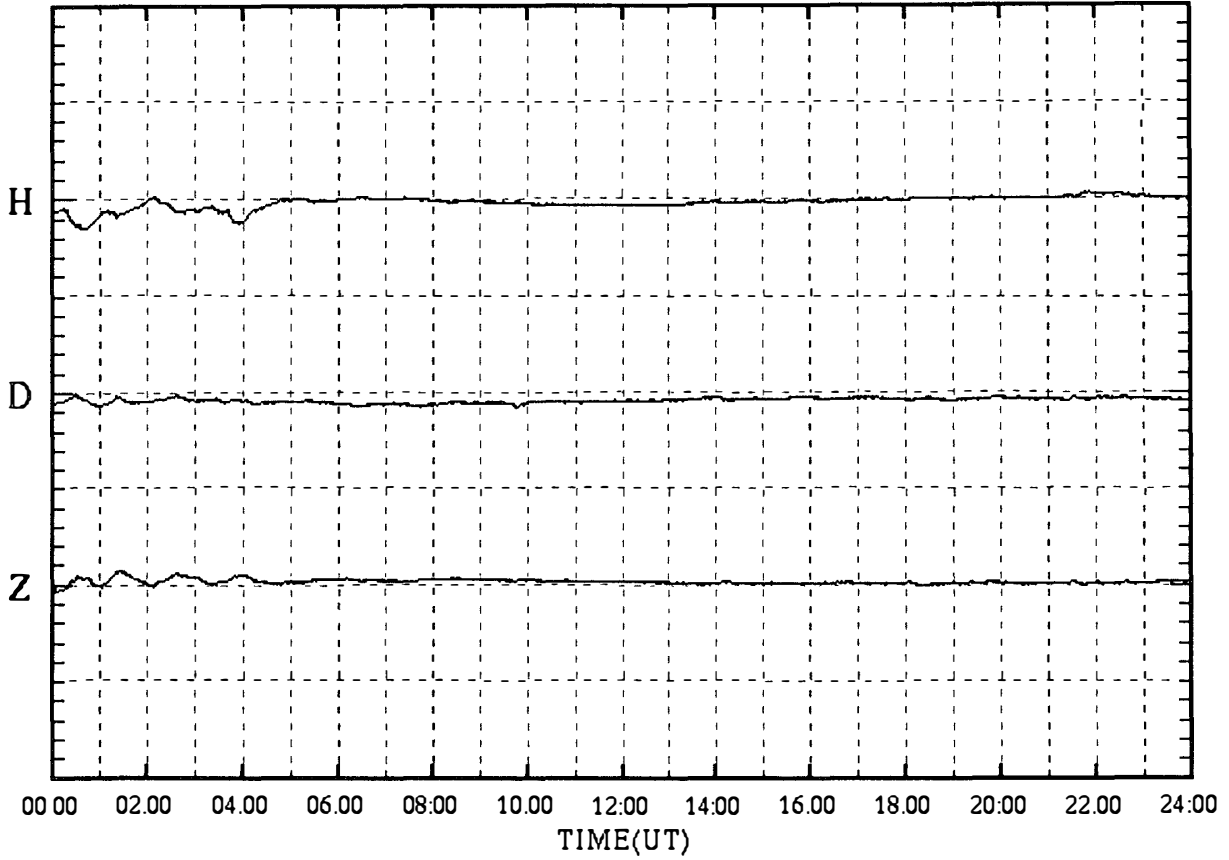

SYOWA magnetogram (100 nT/div)

10 Apr.1999 (DAY:100)

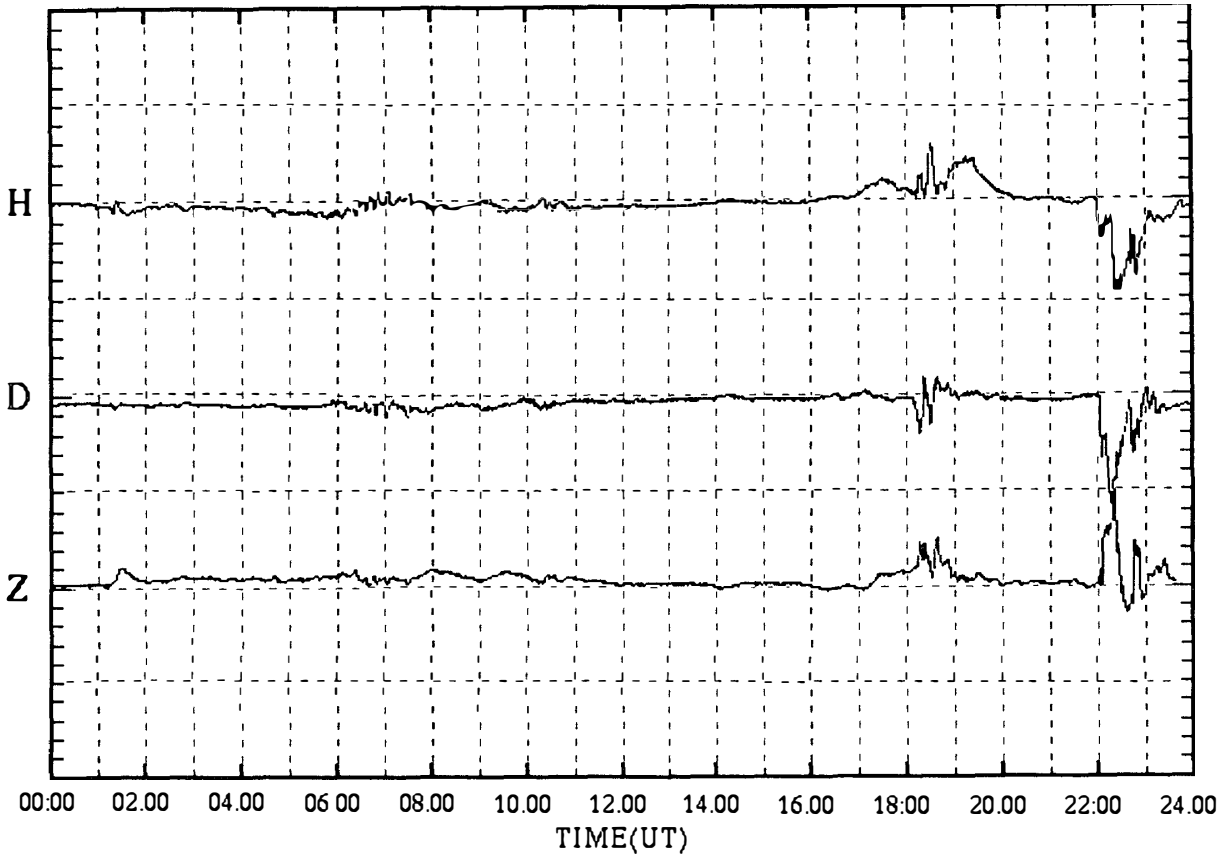

SYOWA magnetogram (100 nT/div)

11 Apr.1999 (DAY:101)

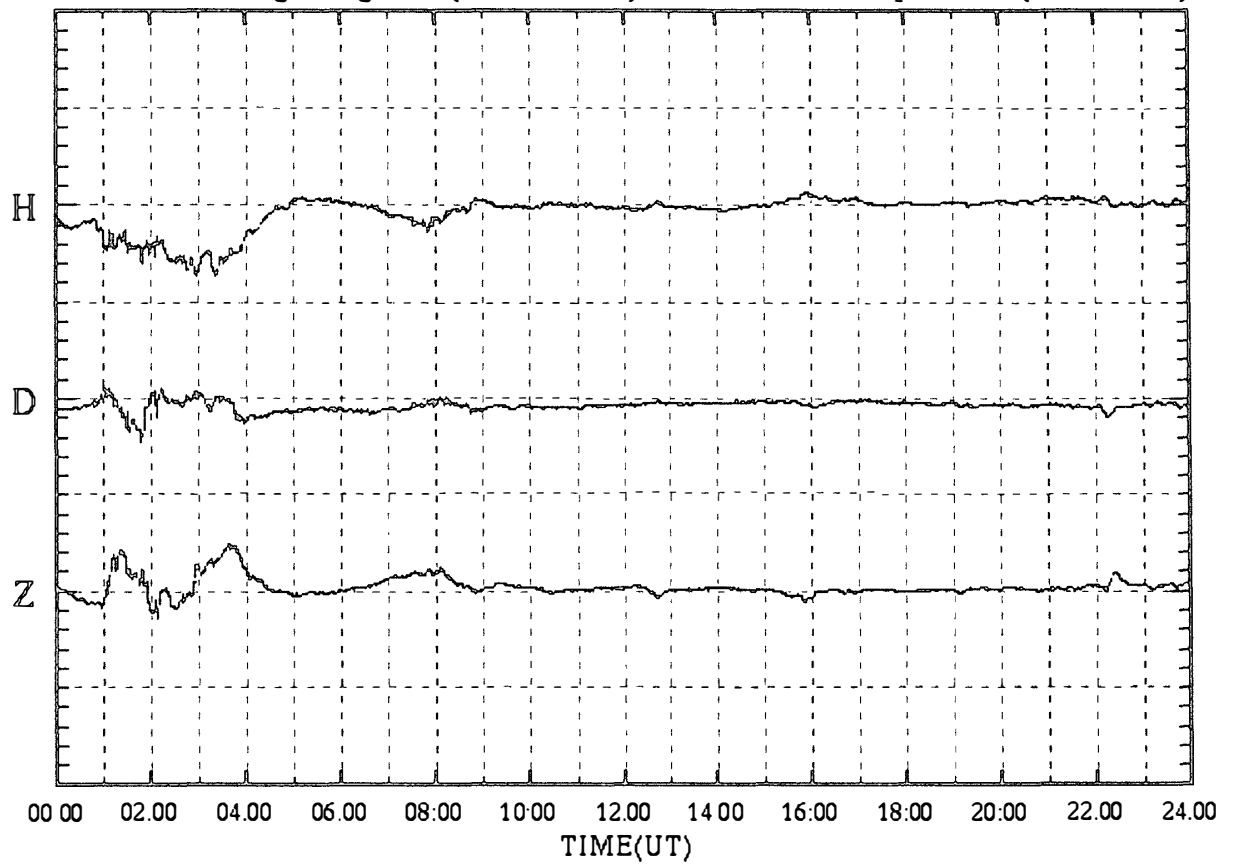

SYOWA magnetogram (100 nT/div)

12 Apr.1999 (DAY:102)

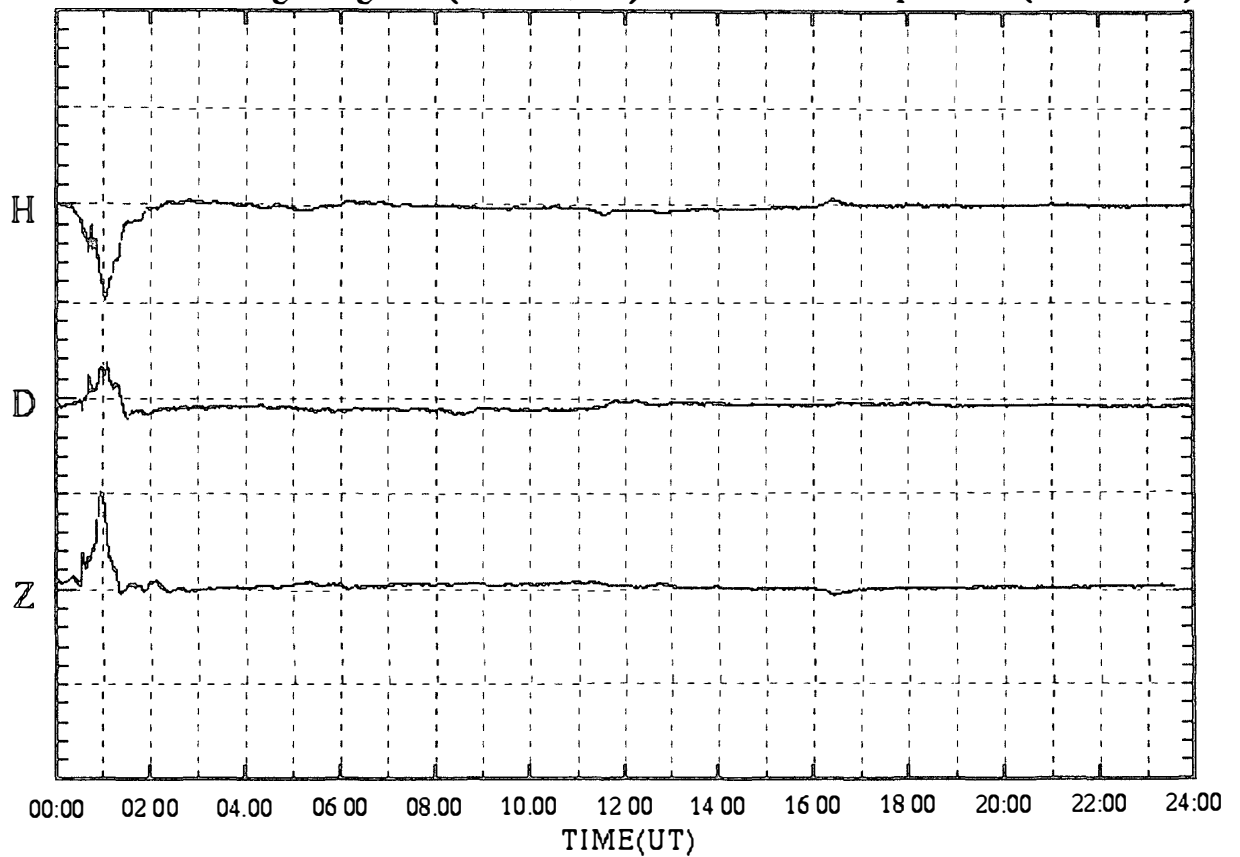

SYOWA magnetogram (100 nT/div)

13 Apr.1999 (DAY:103)

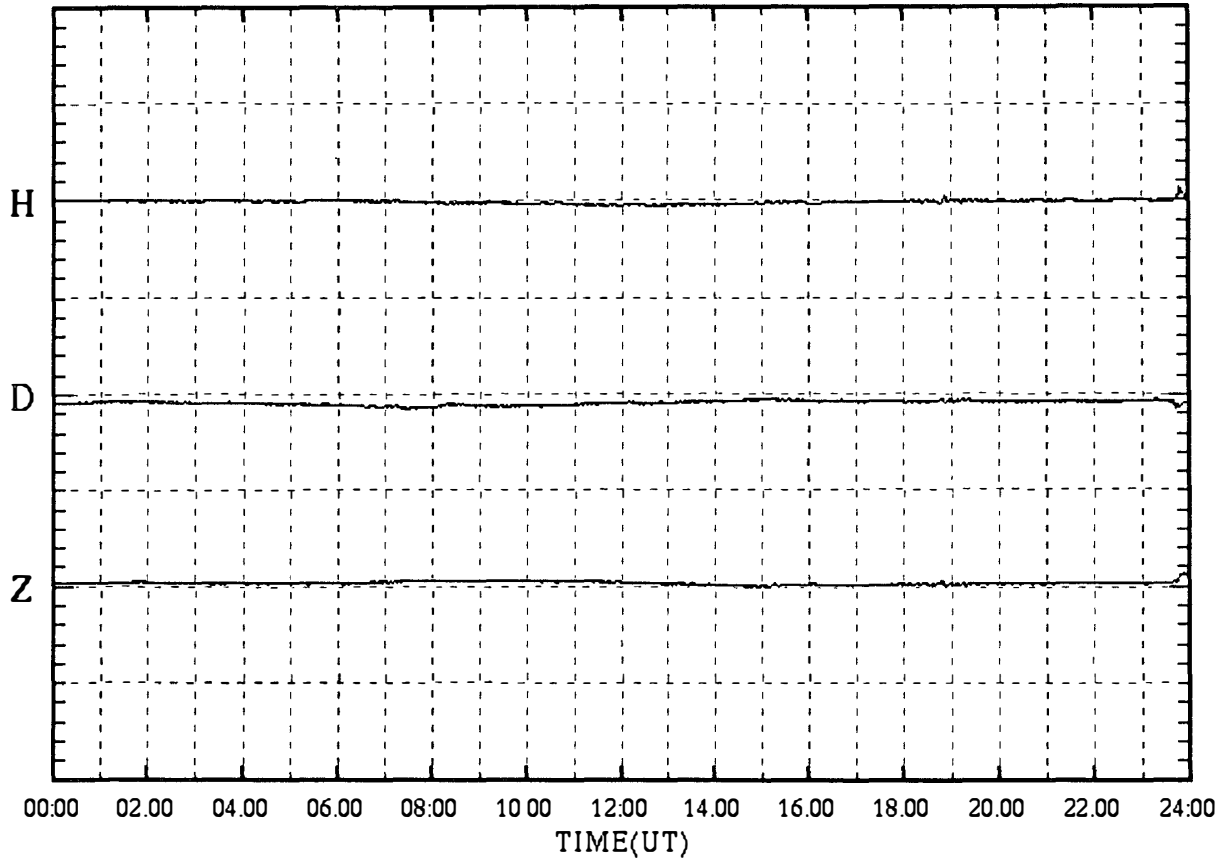

SYOWA magnetogram (100 nT/div)

14 Apr.1999 (DAY:104)

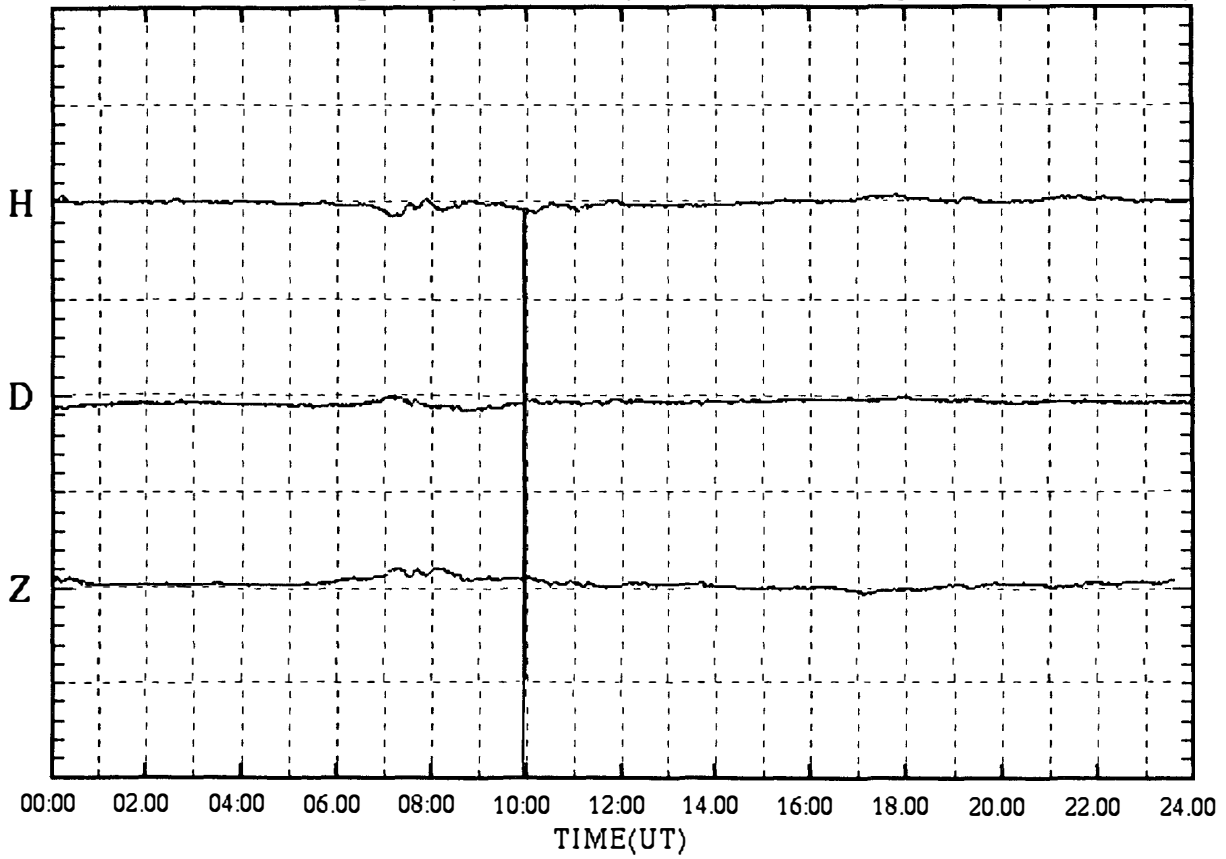

SYOWA magnetogram (100 nT/div)

15 Apr.1999 (DAY:105)

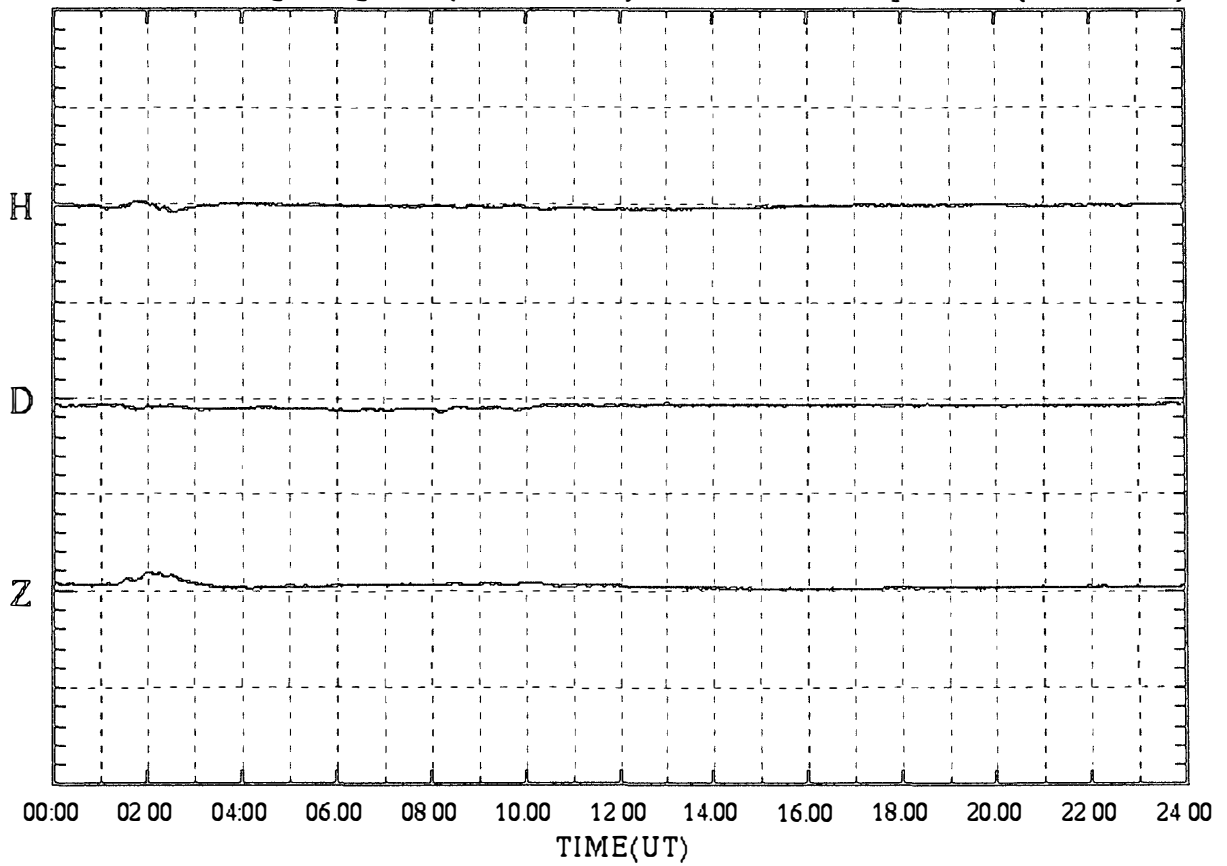

SYOWA magnetogram (100 nT/div)

16 Apr.1999 (DAY:106)

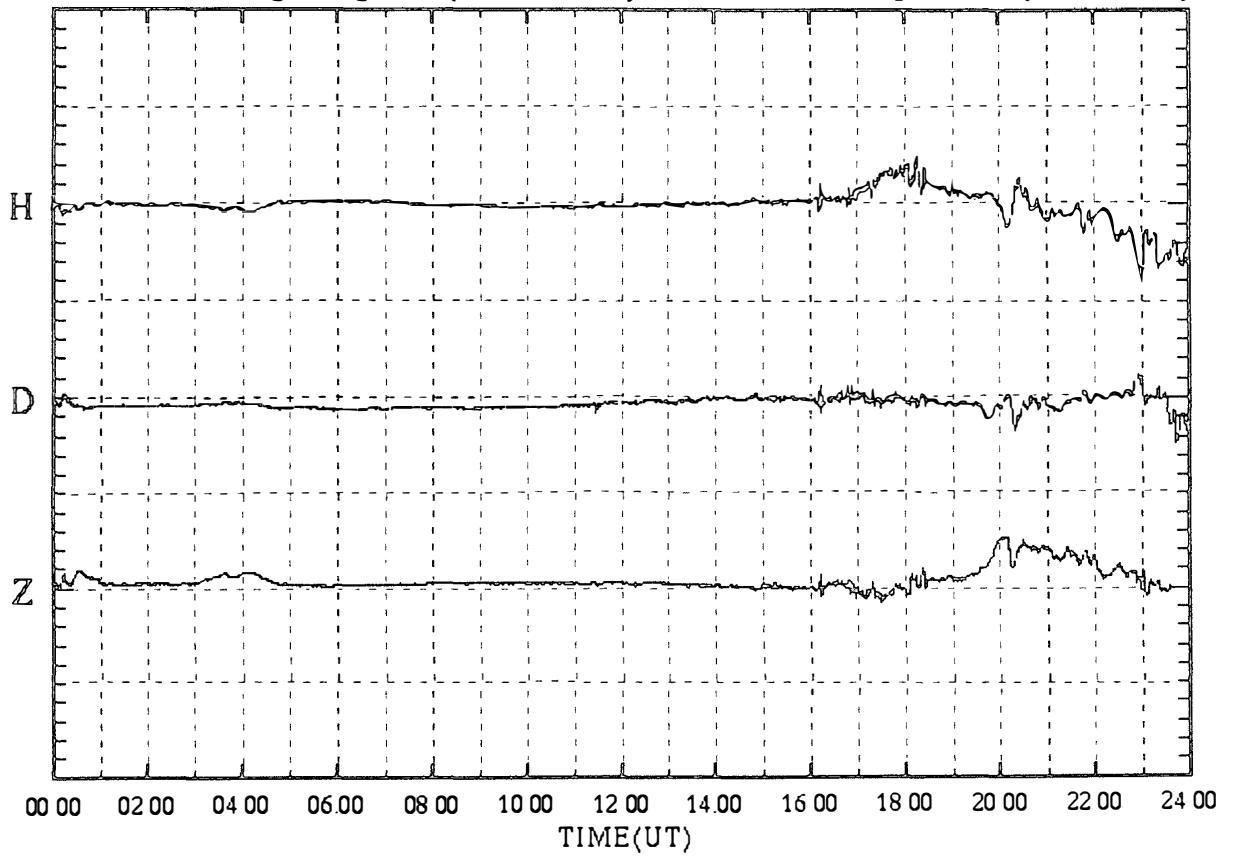

SYOWA magnetogram (100 nT/div)

17 Apr.1999 (DAY:107)

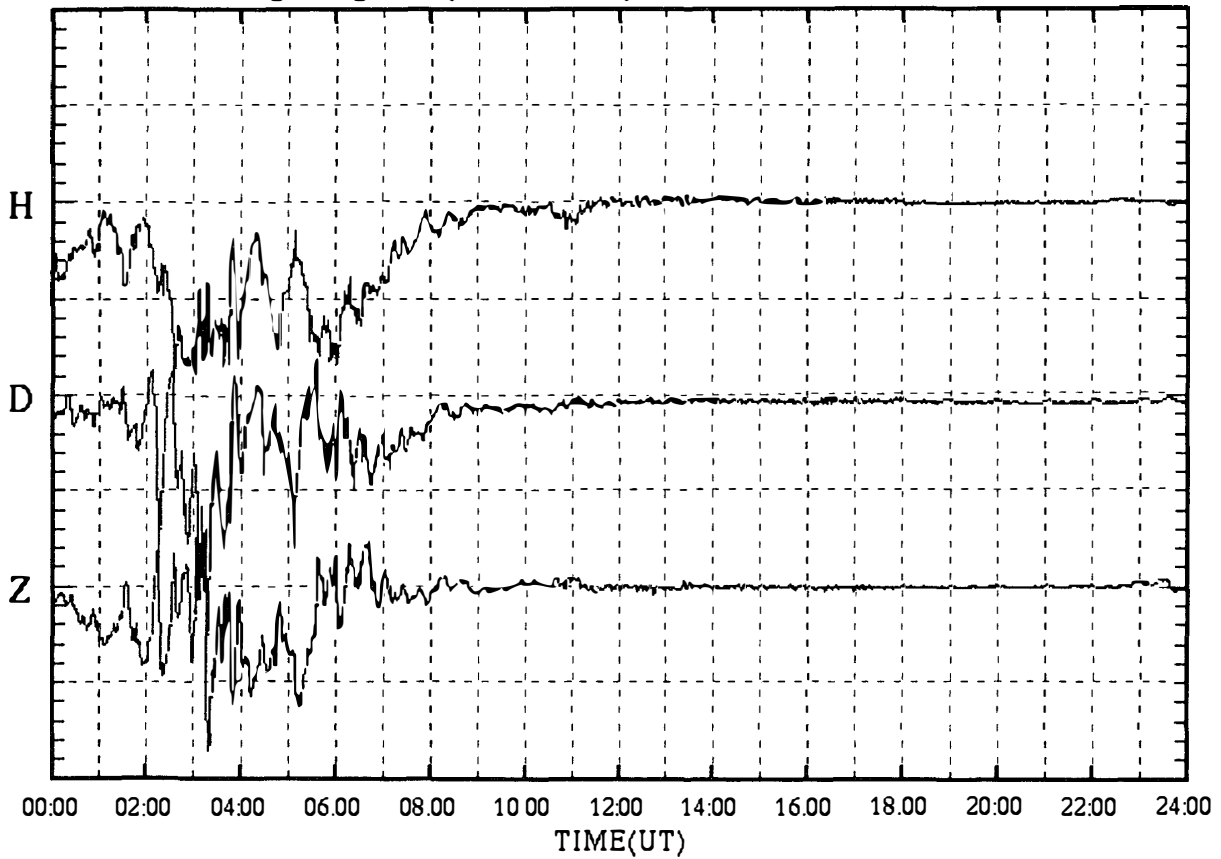

SYOWA magnetogram (100 nT/div)

18 Apr.1999 (DAY:108)

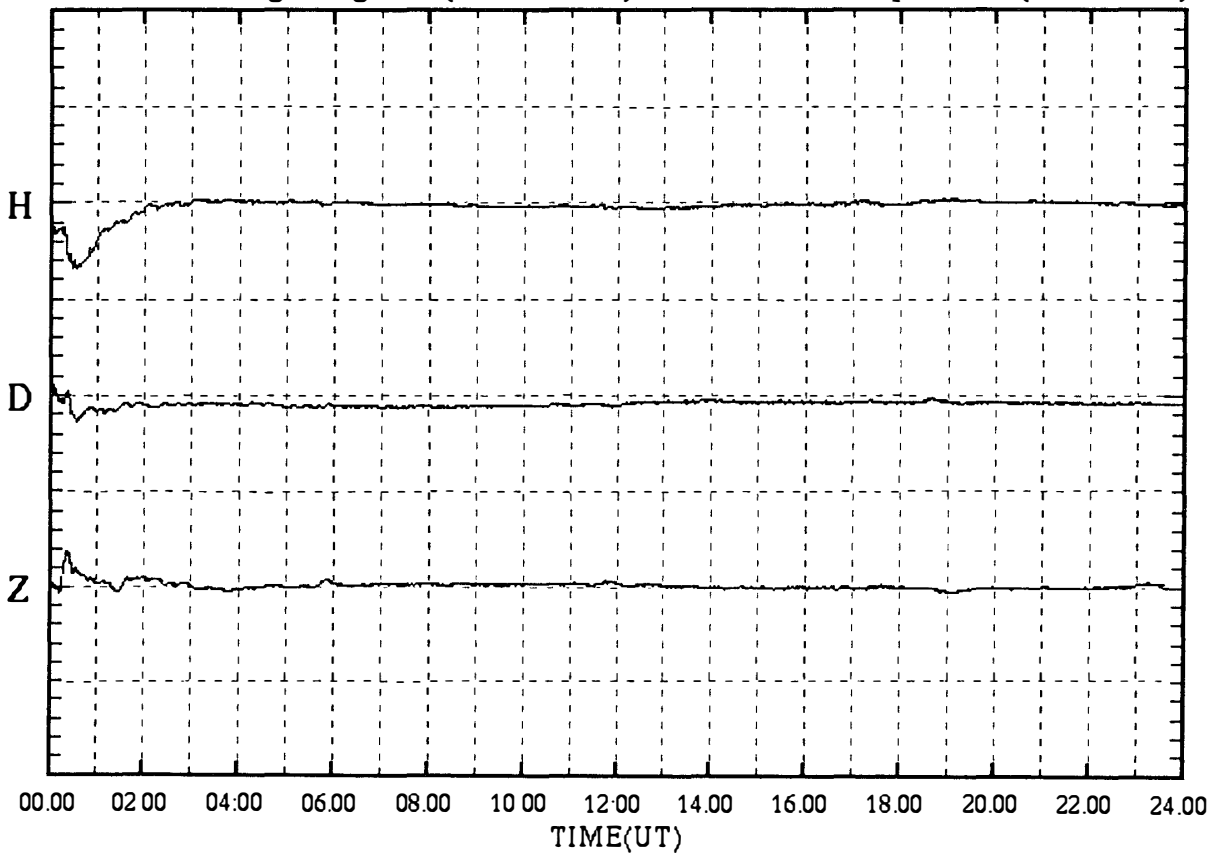

SYOWA magnetogram (100 nT/div)

19 Apr.1999 (DAY:109)

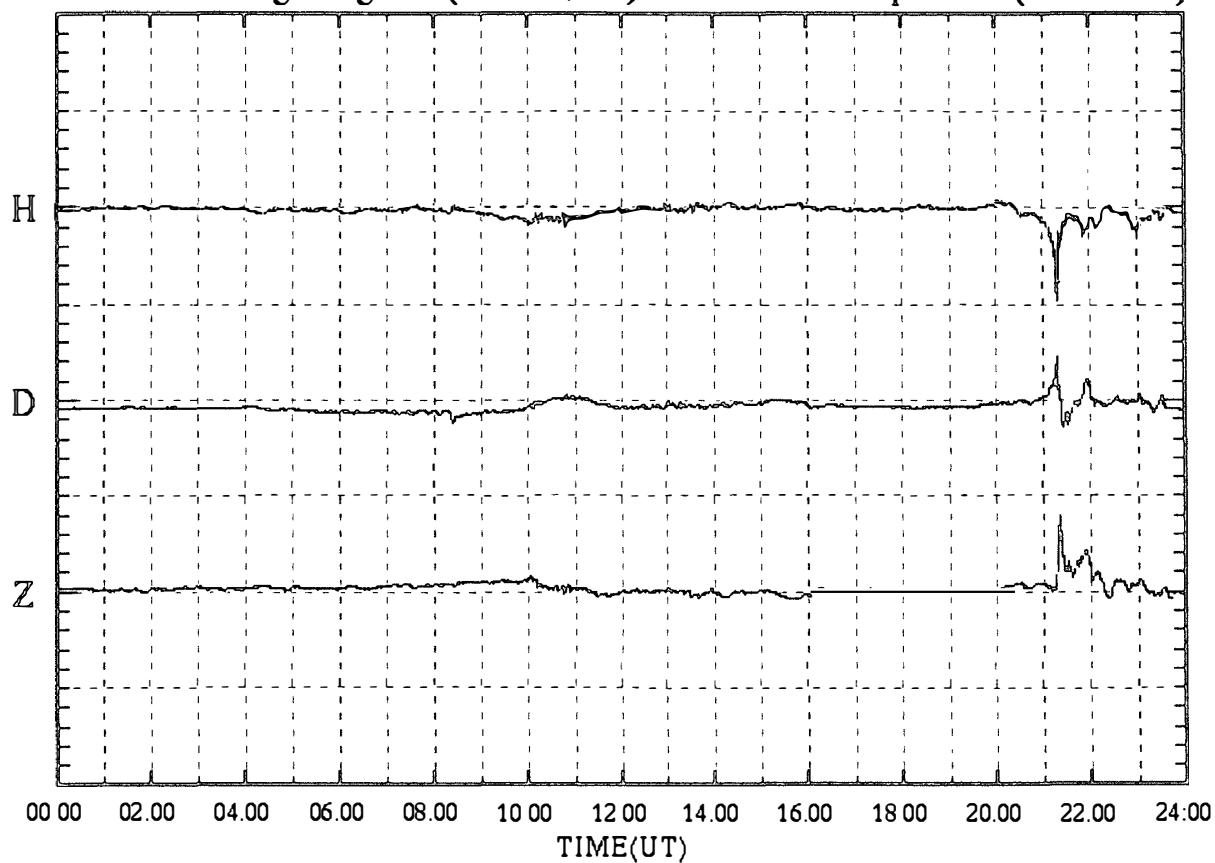

SYOWA magnetogram (100 nT/div)

20 Apr.1999 (DAY:110)

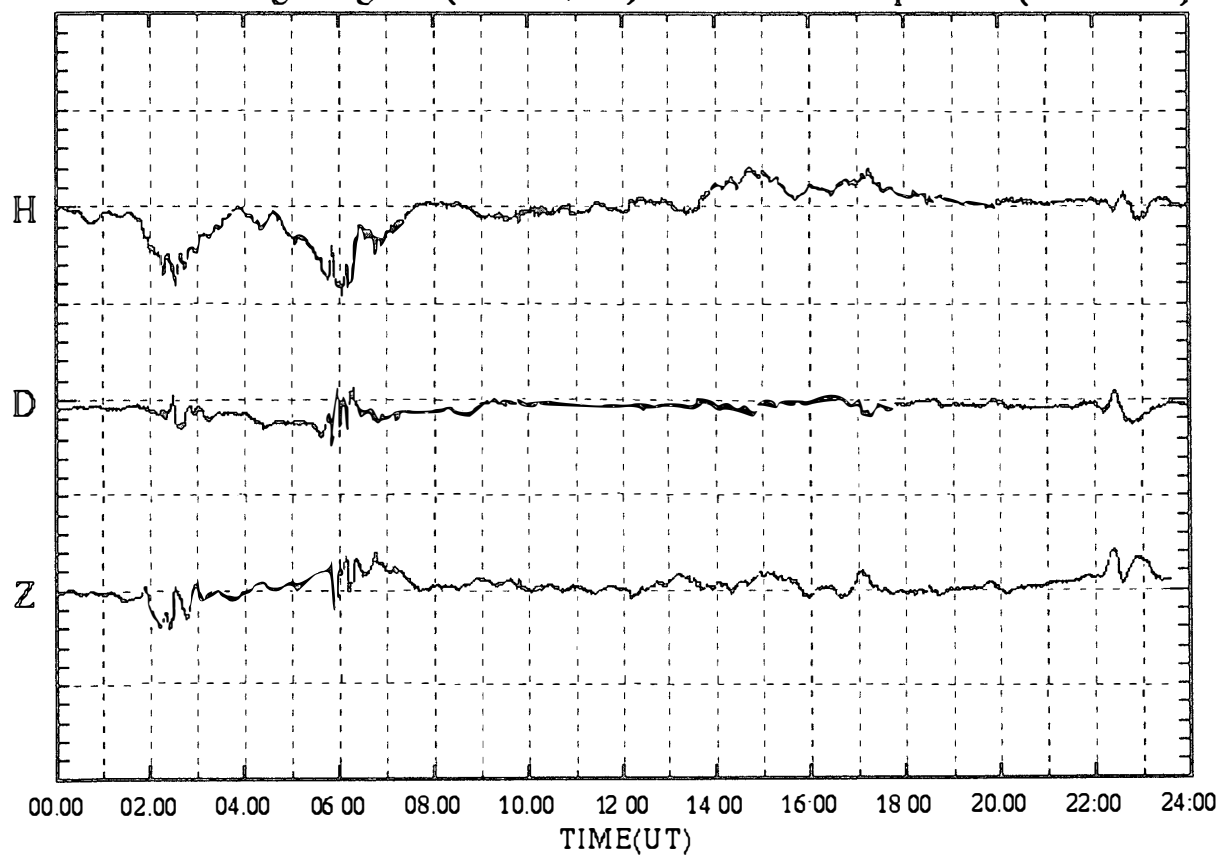

SYOWA magnetogram (100 nT/div)

21 Apr.1999 (DAY:111)

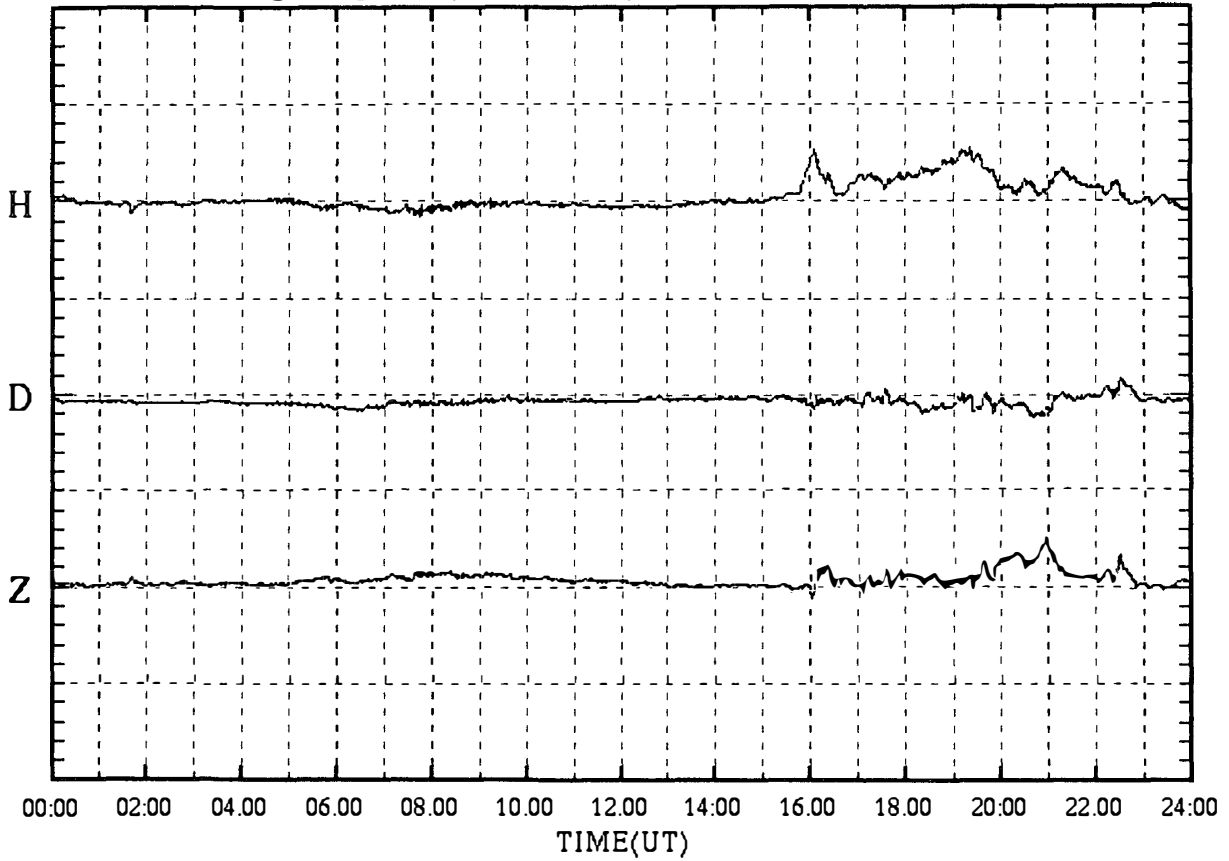

SYOWA magnetogram (100 nT/div)

22 Apr.1999 (DAY:112)

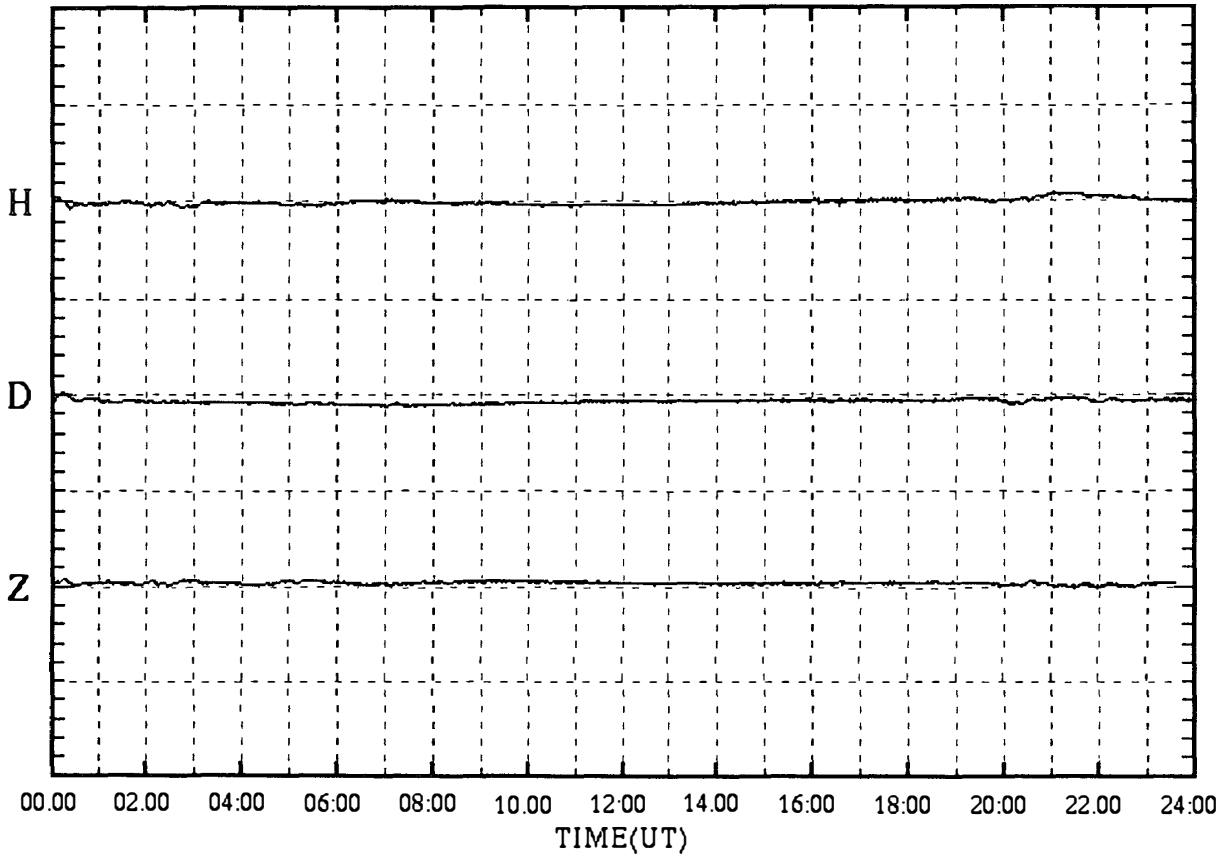



SYOWA magnetogram (100 nT/div)

23 Apr.1999 (DAY:113)

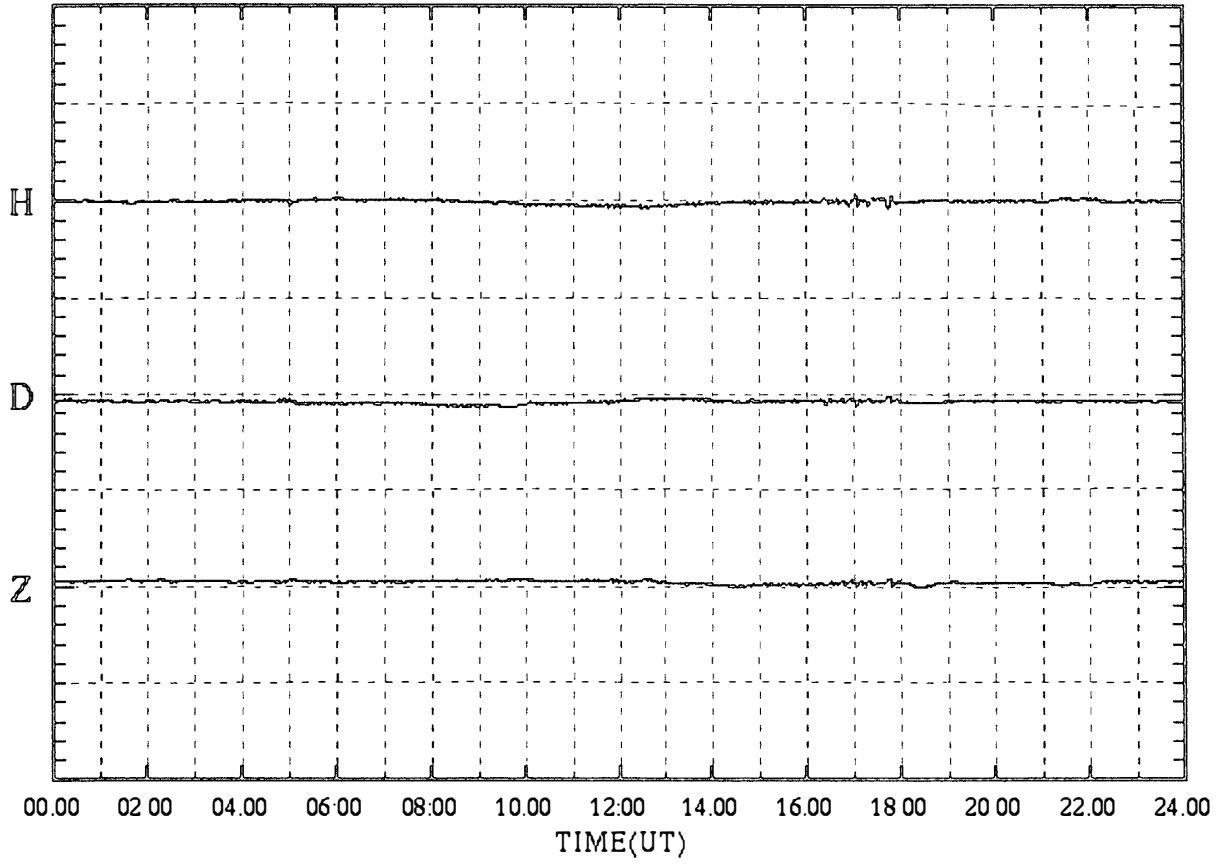

SYOWA magnetogram (100 nT/div)

24 Apr.1999 (DAY:114)

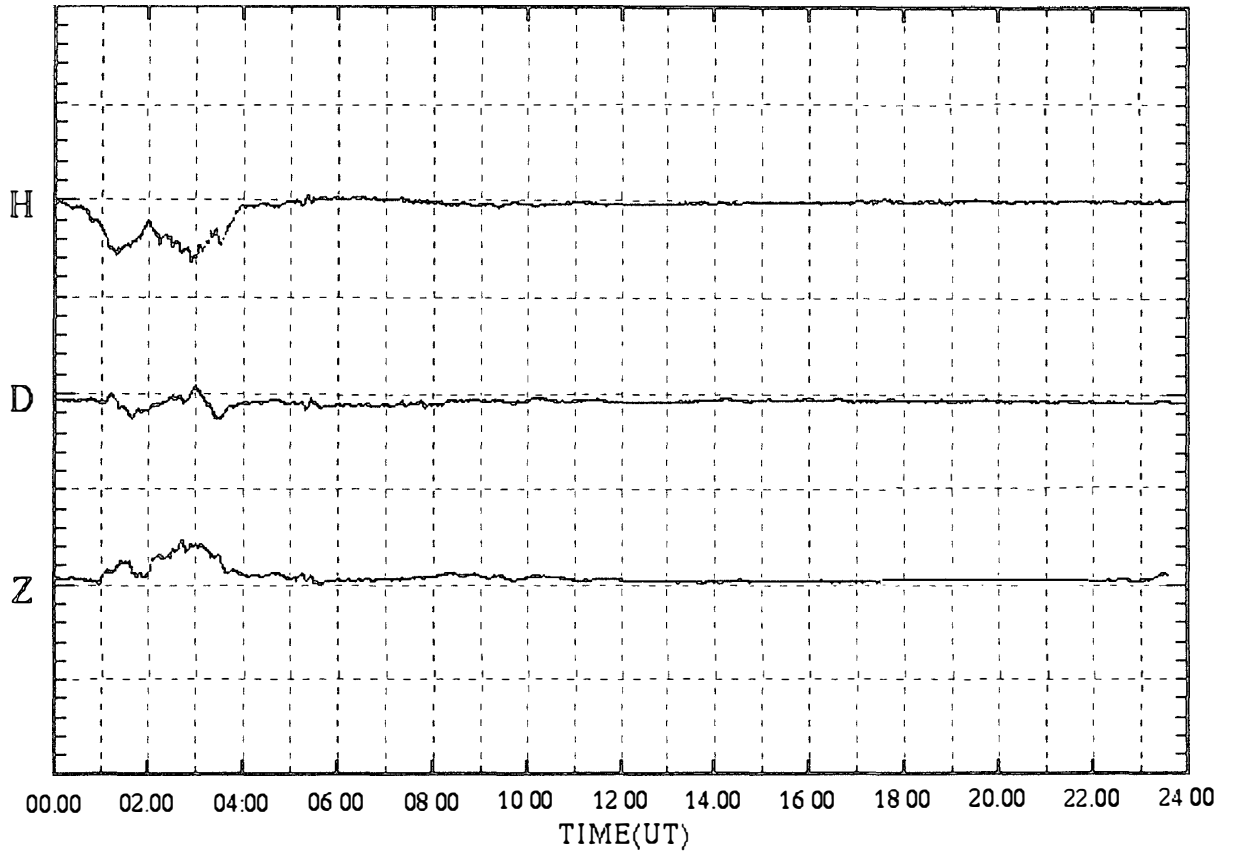

SYOWA magnetogram (100 nT/div)

25 Apr.1999 (DAY:115)

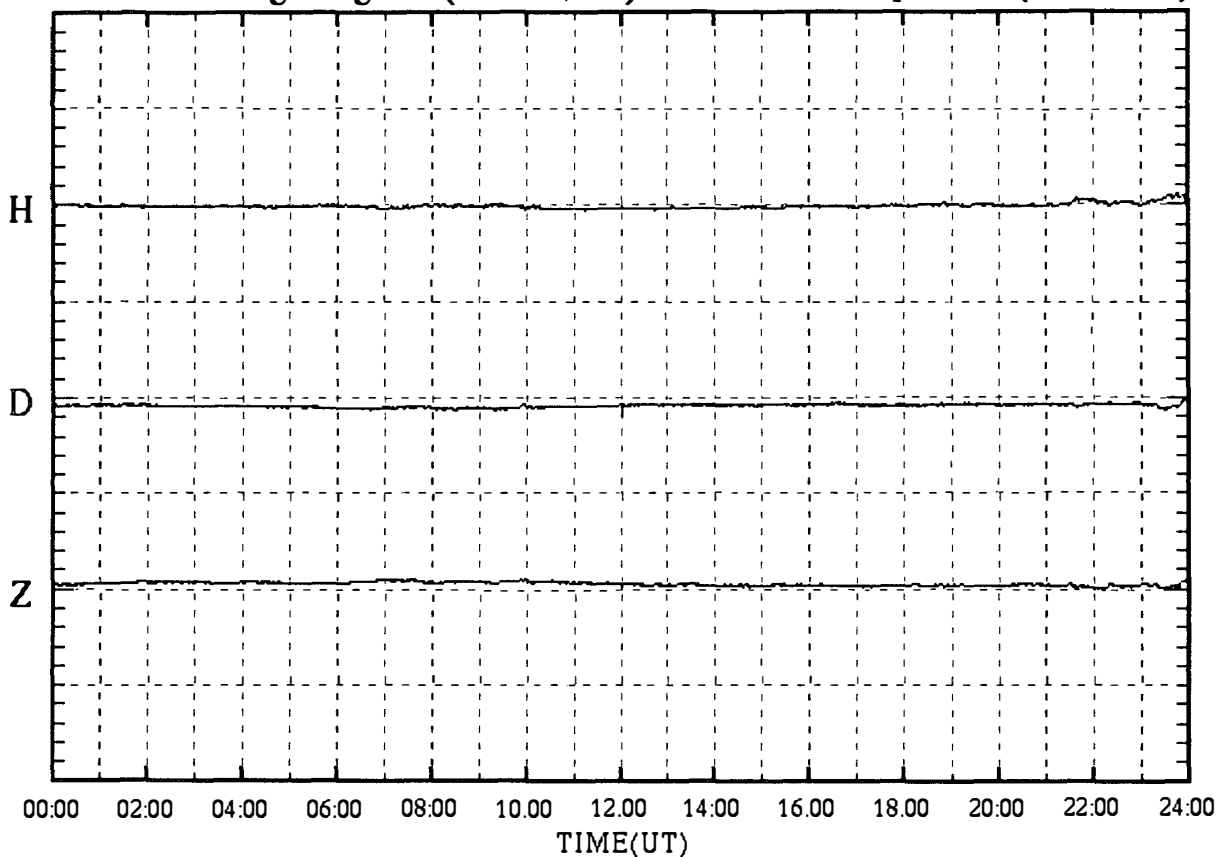

SYOWA magnetogram (100 nT/div)

26 Apr.1999 (DAY:116)

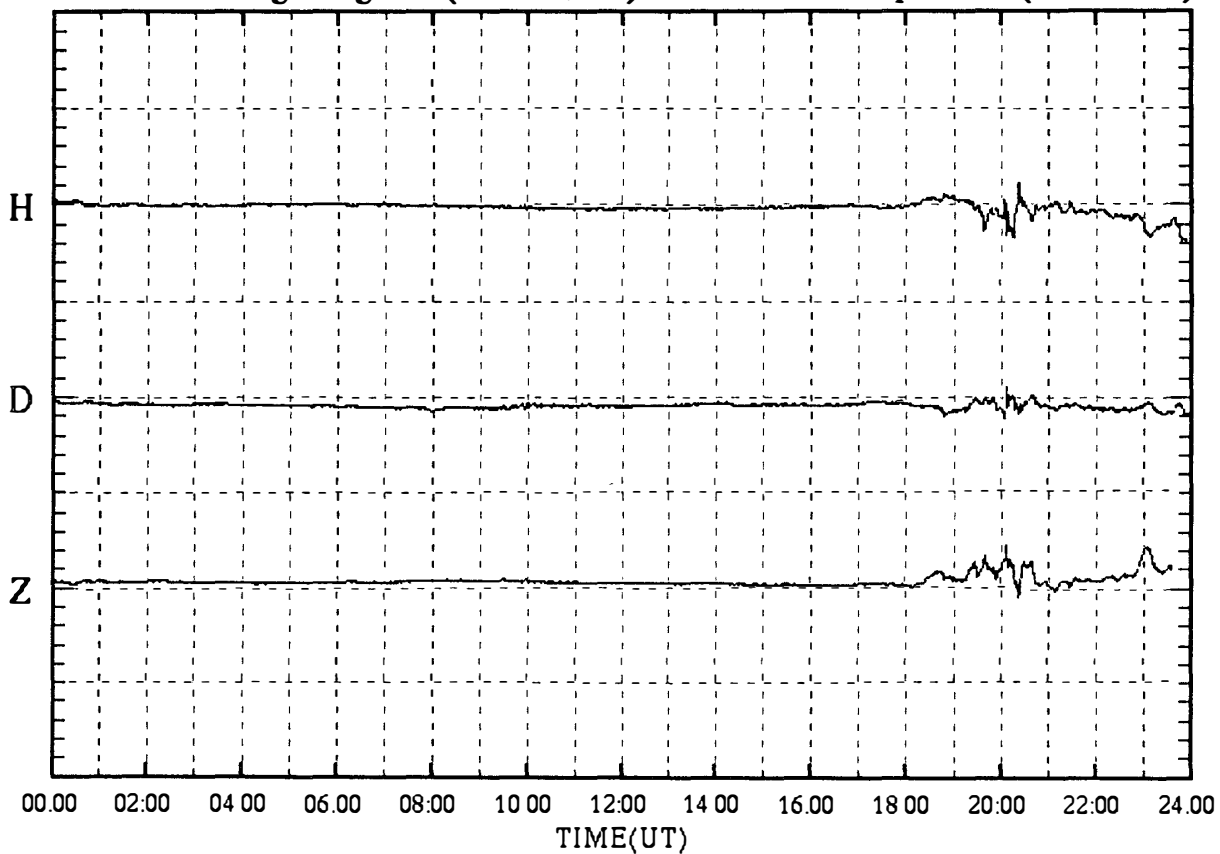

SYOWA magnetogram (100 nT/div)

27 Apr.1999 (DAY:117)

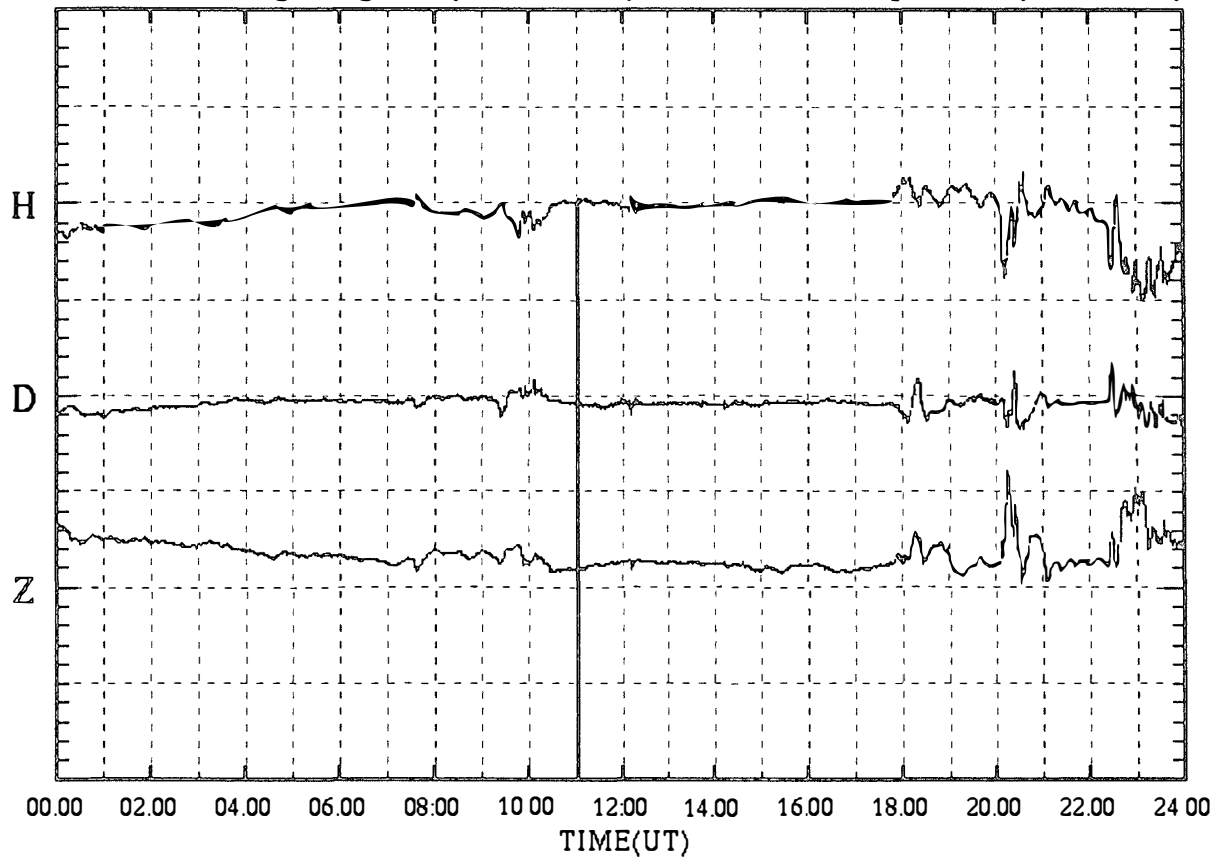

SYOWA magnetogram (100 nT/div)

28 Apr.1999 (DAY:118)

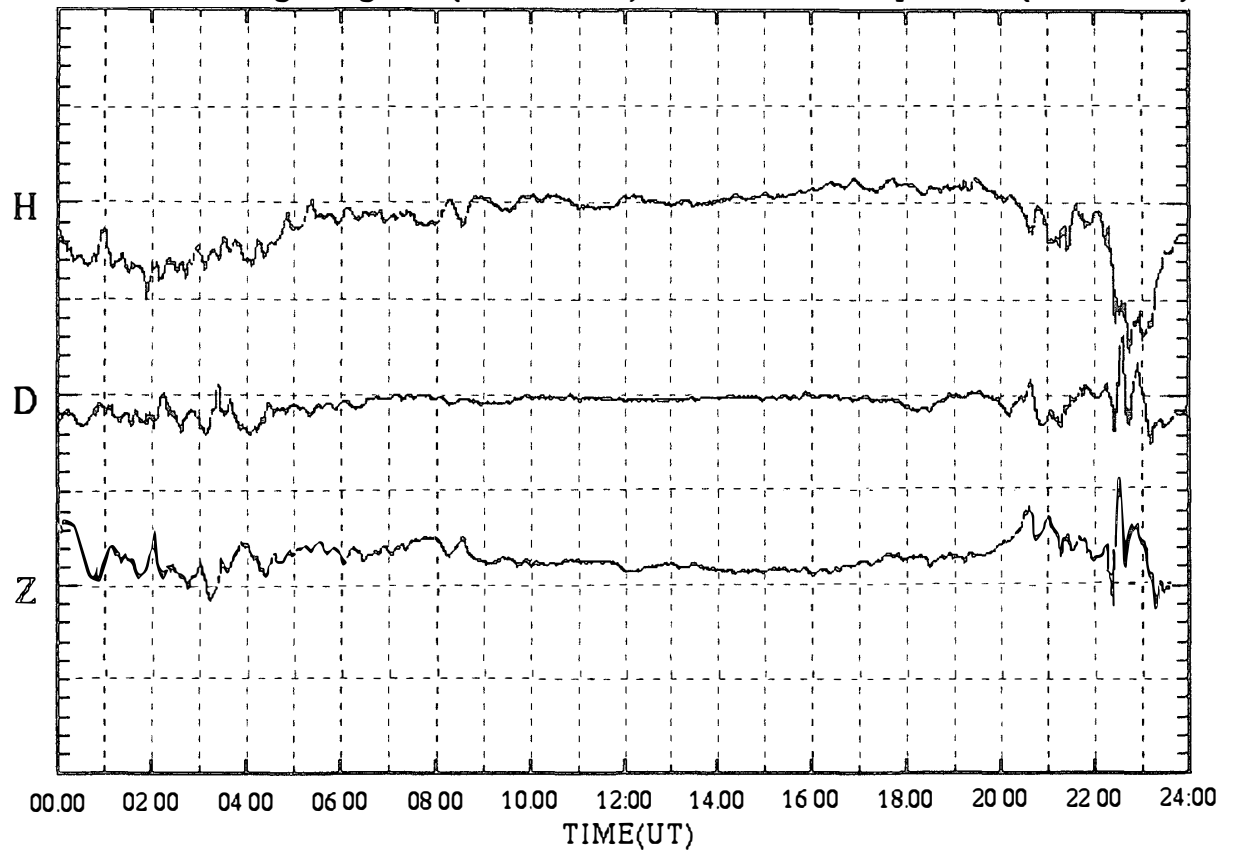

SYOWA magnetogram (100 nT/div)

29 Apr.1999 (DAY:119)

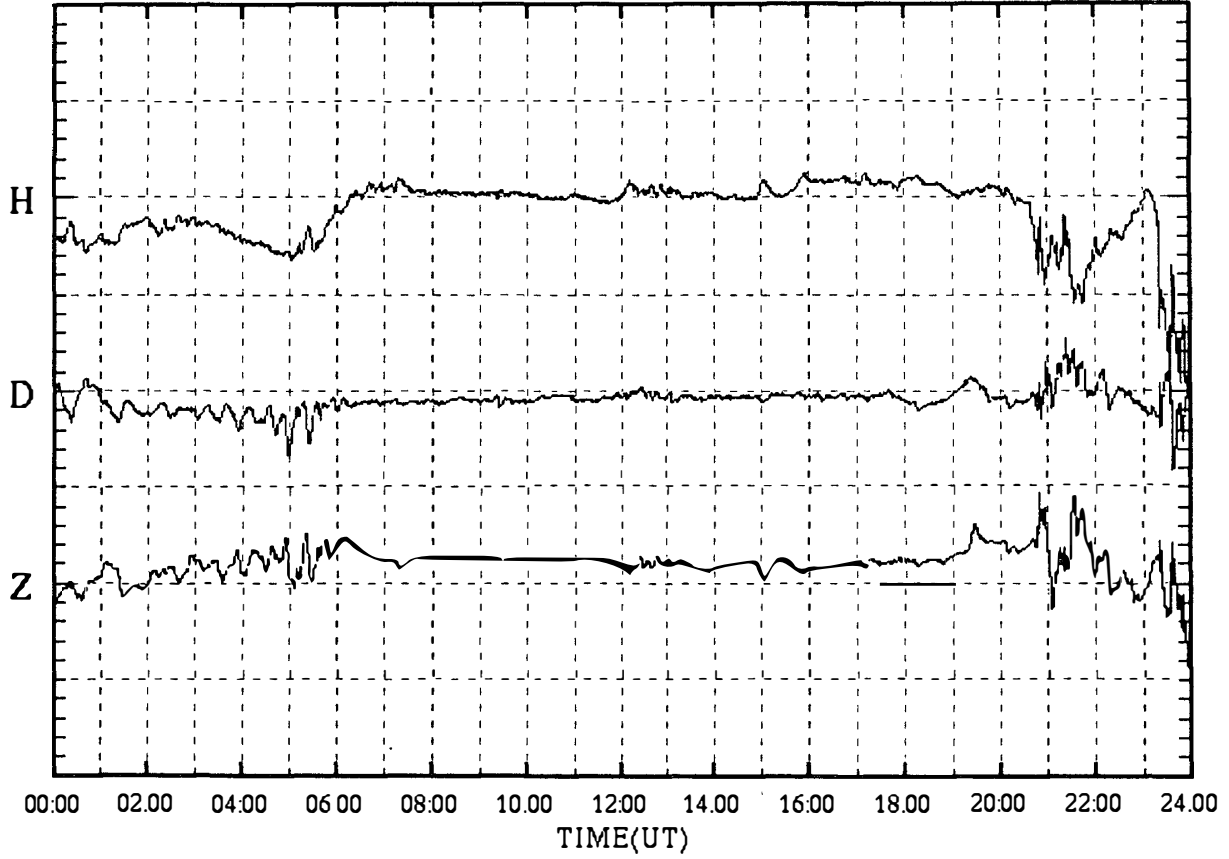

SYOWA magnetogram (100 nT/div)

30 Apr.1999 (DAY:120)

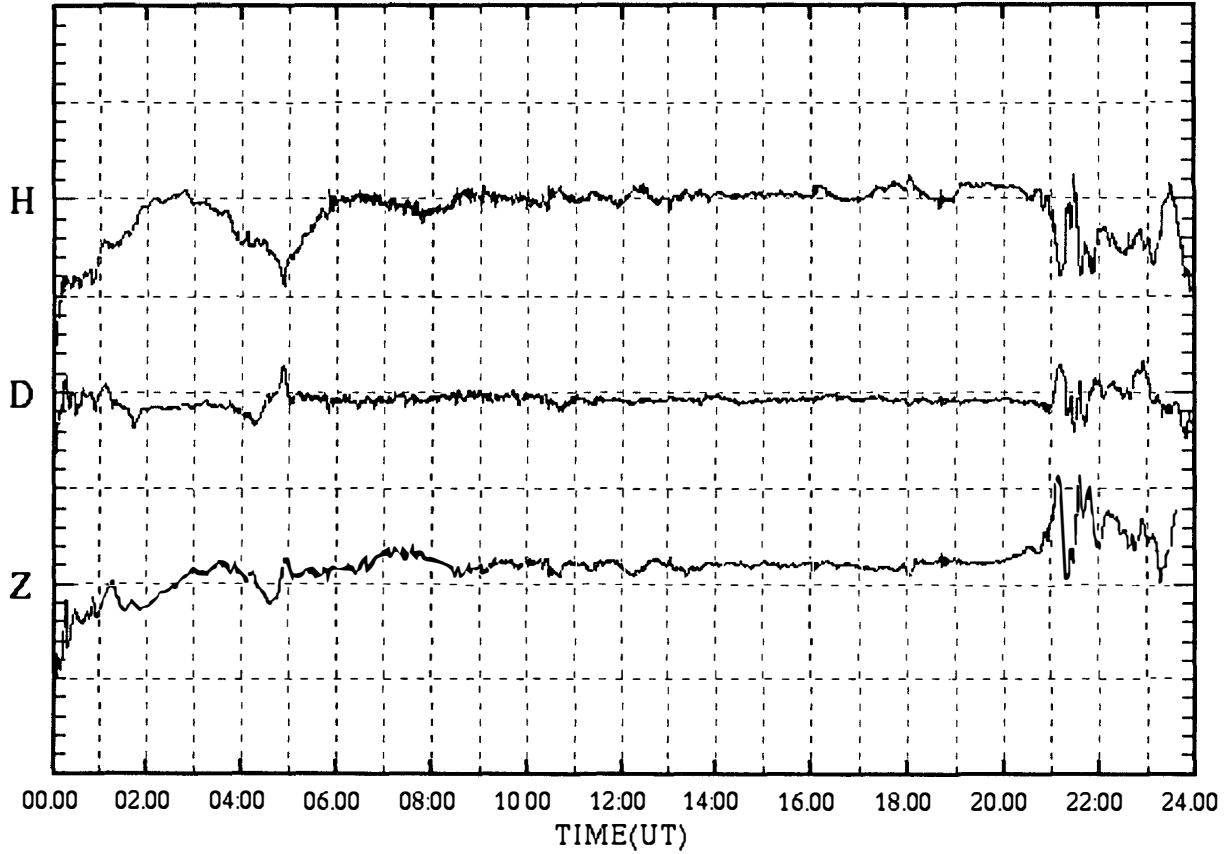

SYOWA magnetogram (100 nT/div)

01 May 1999 (DAY:121)

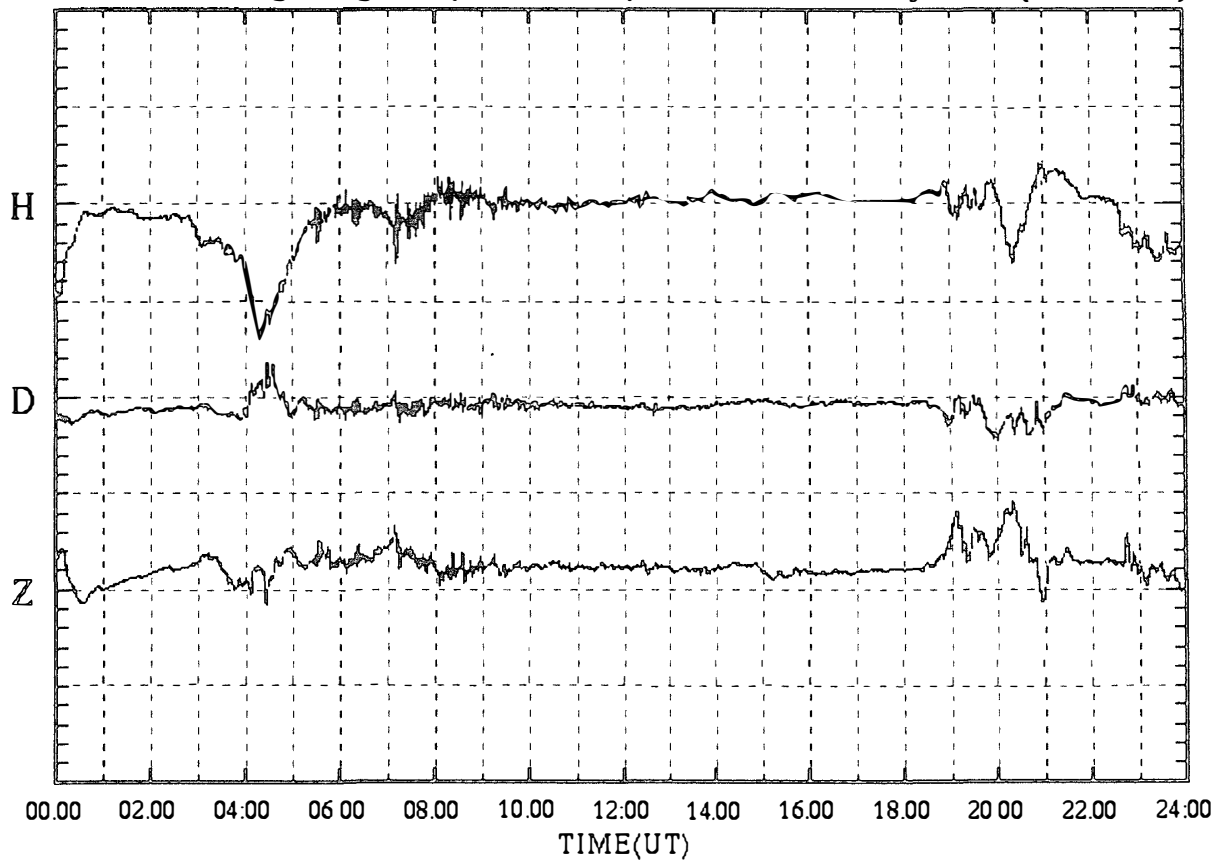

SYOWA magnetogram (100 nT/div)

02 May 1999 (DAY:122)

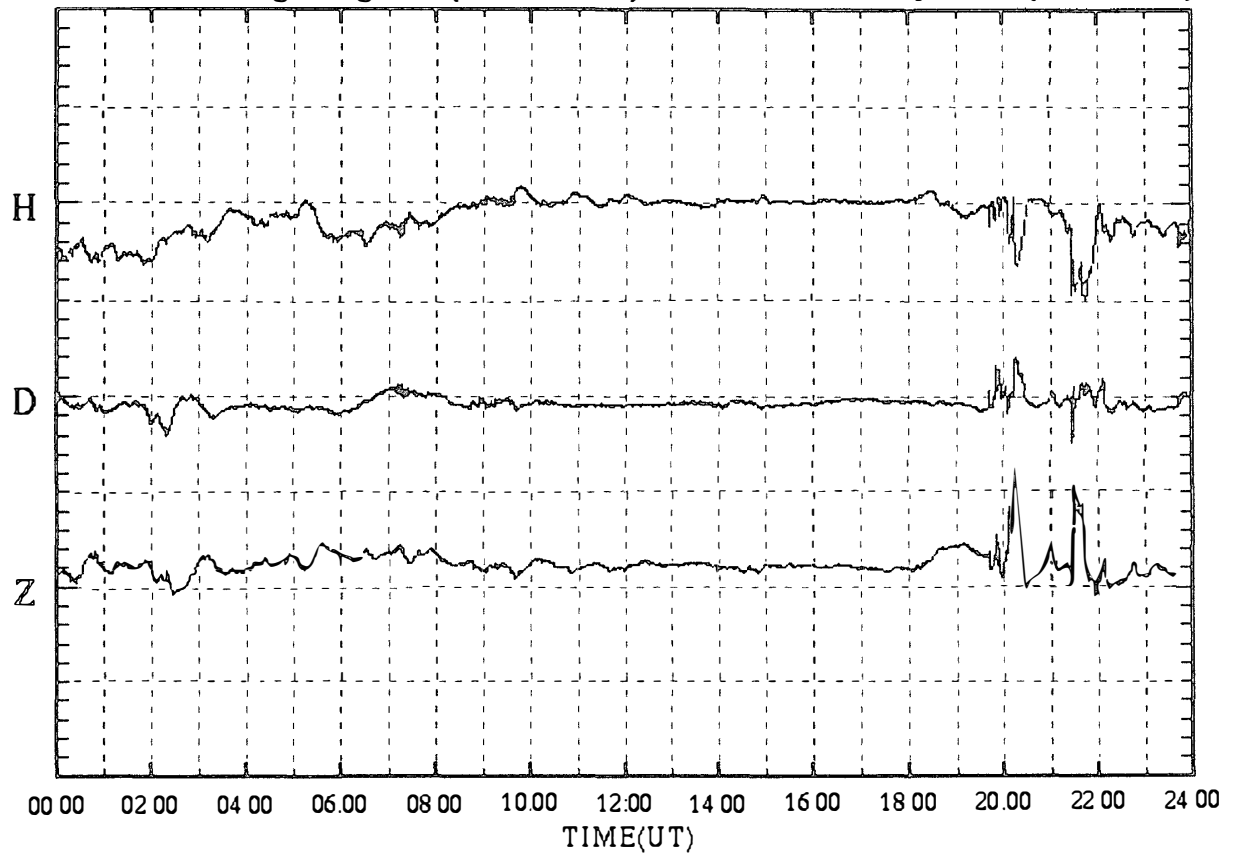

SYOWA magnetogram (100 nT/div)

03 May 1999 (DAY:123)

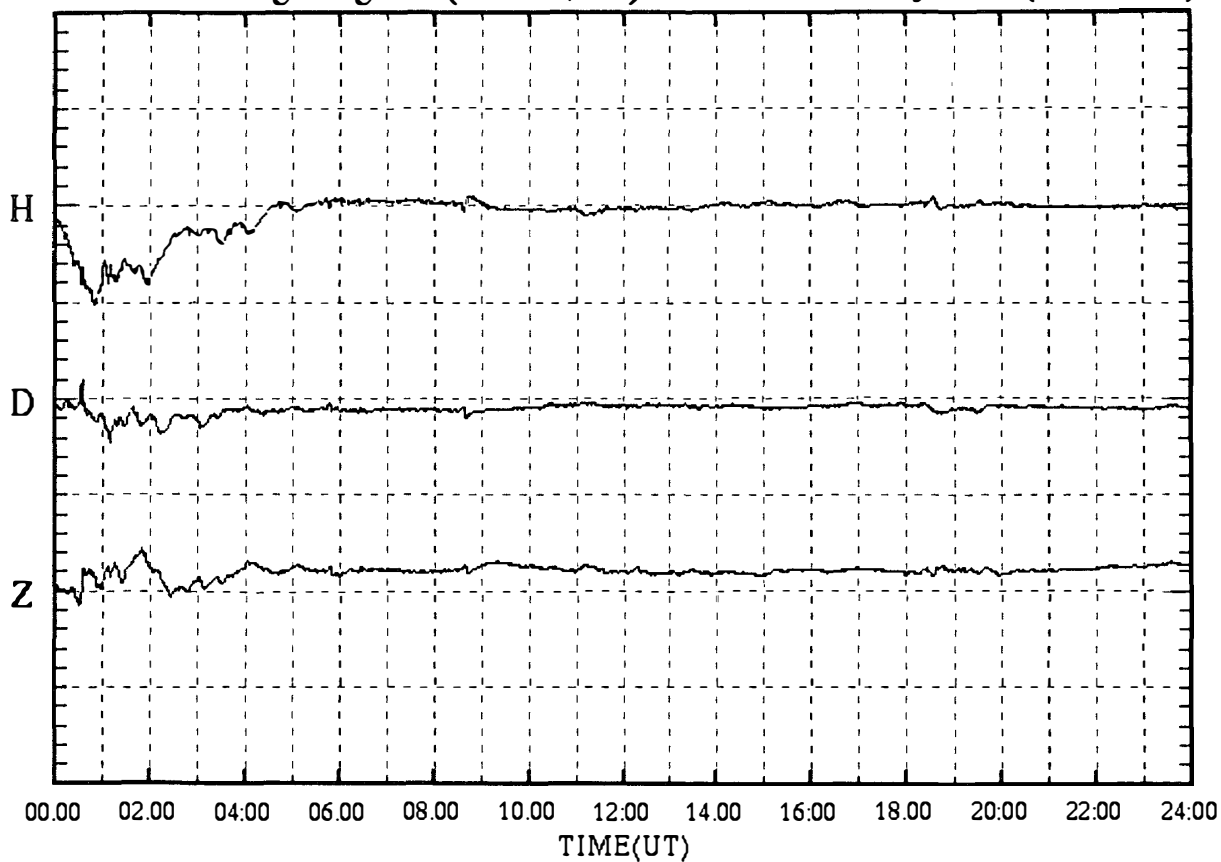

SYOWA magnetogram (100 nT/div)

04 May 1999 (DAY:124)

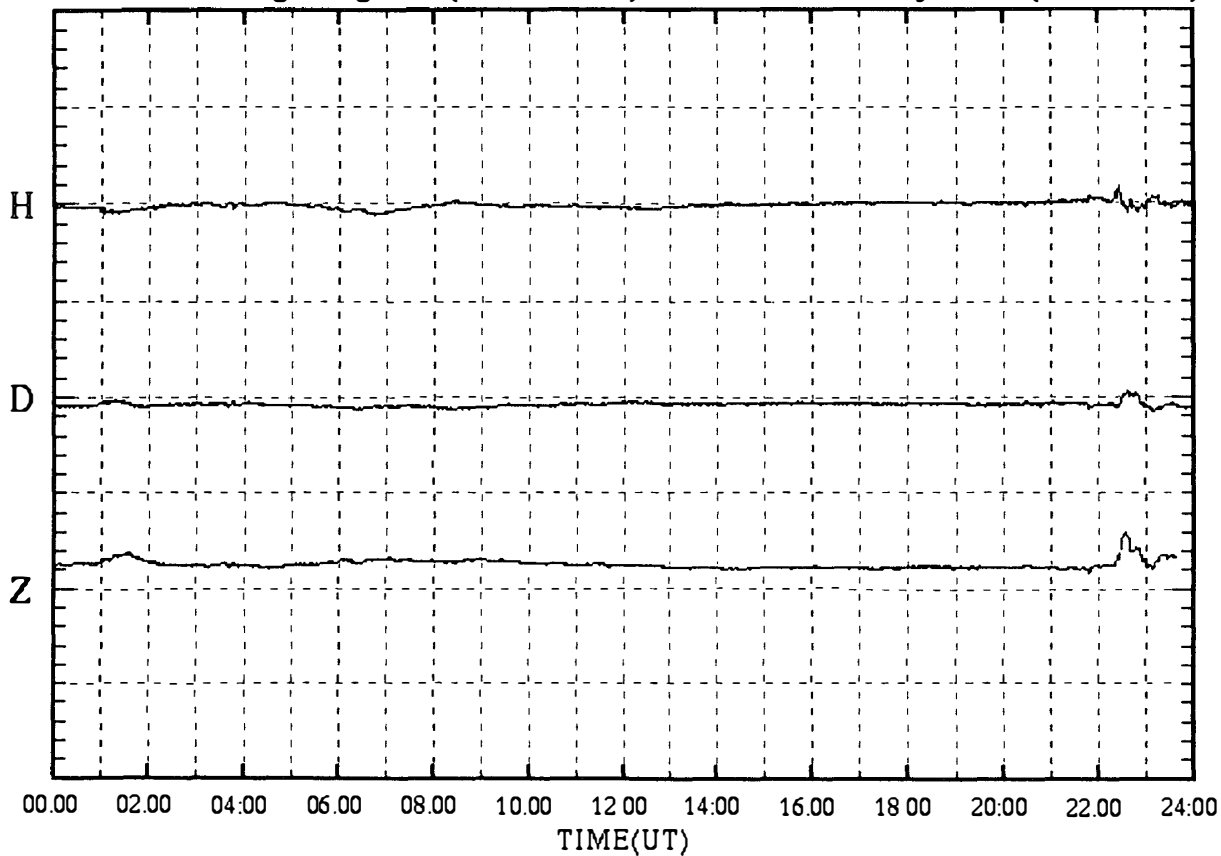

SYOWA magnetogram (100 nT/div)

05 May 1999 (DAY:125)

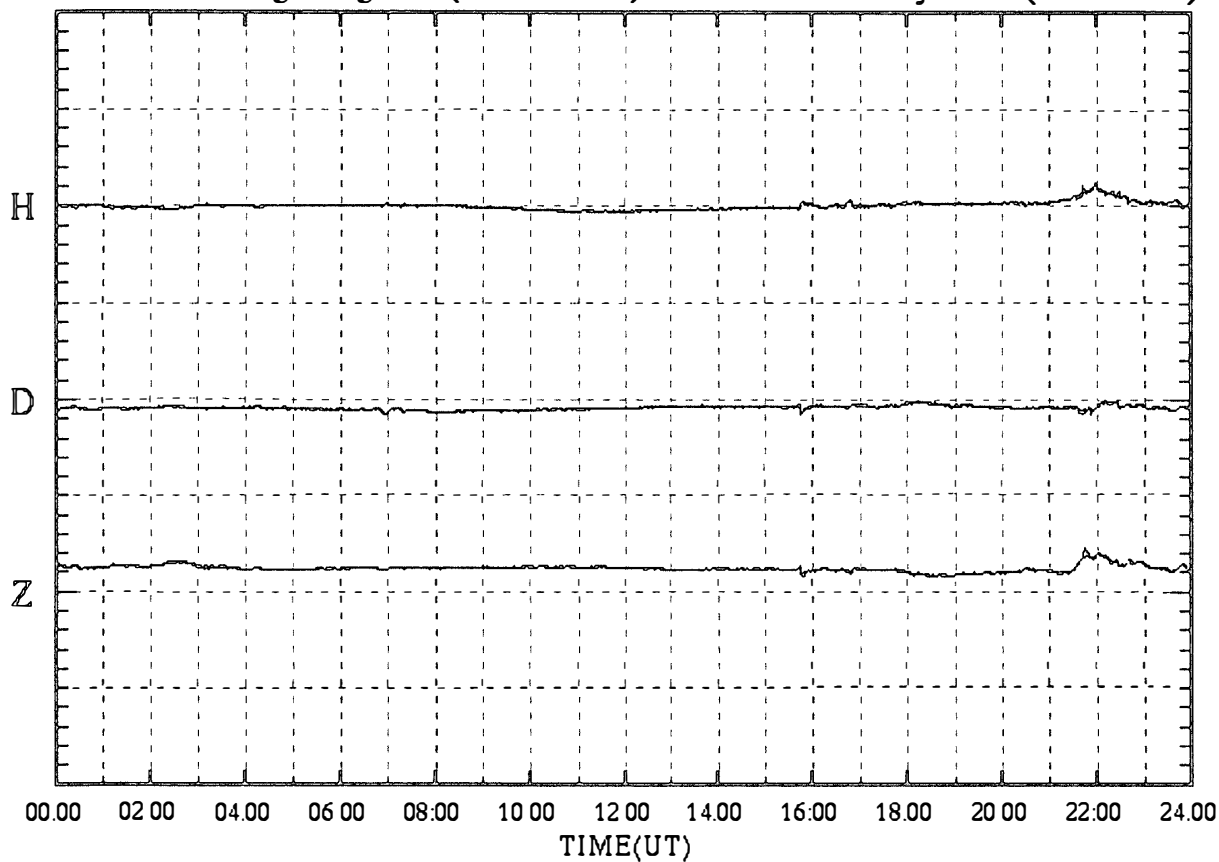

SYOWA magnetogram (100 nT/div)

06 May 1999 (DAY:126)

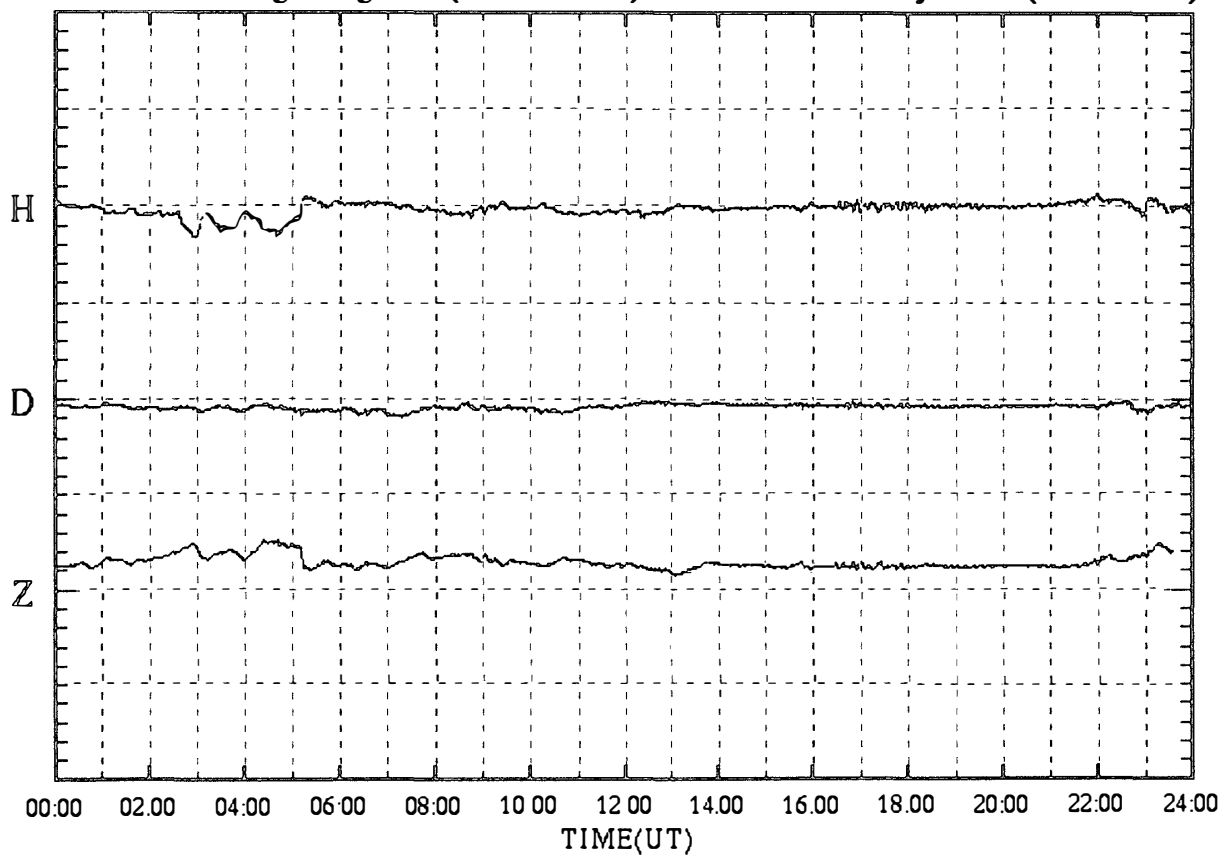

SYOWA magnetogram (100 nT/div)

07 May 1999 (DAY:127)

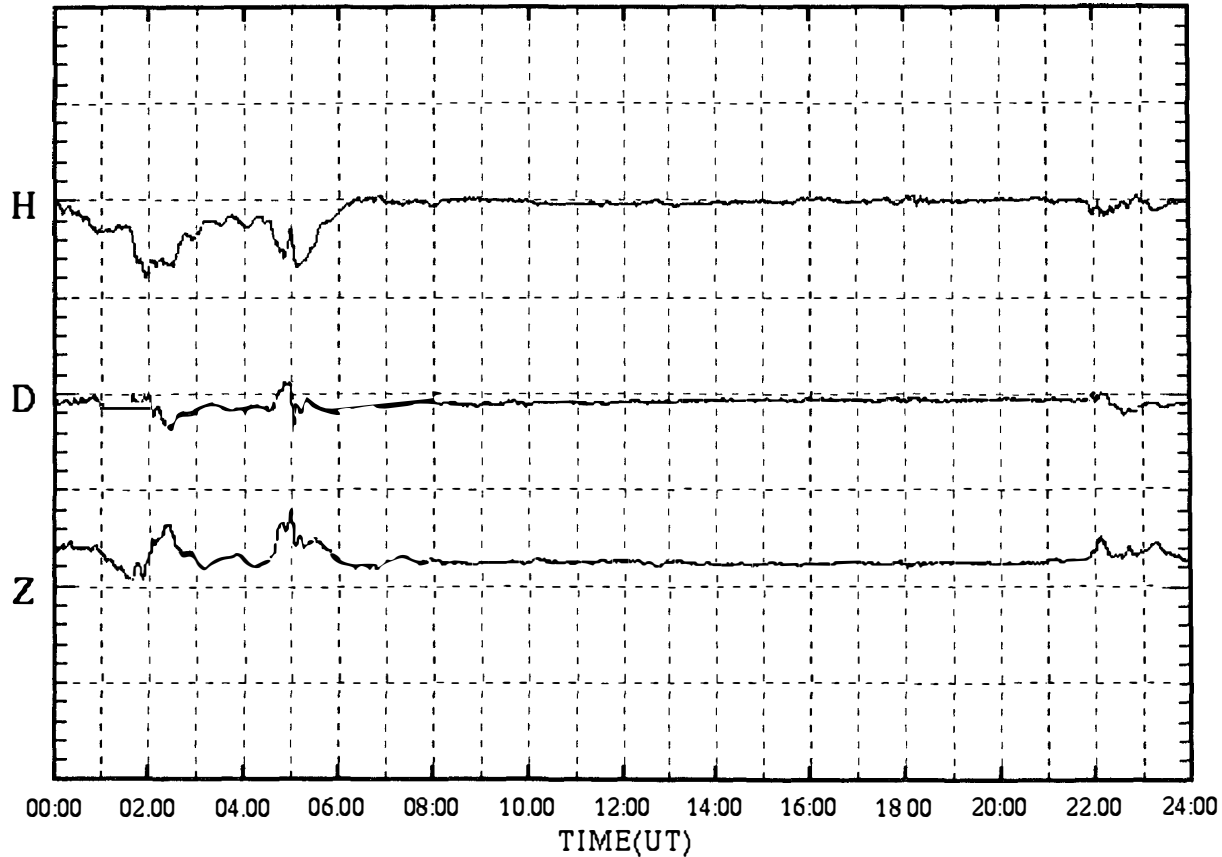

SYOWA magnetogram (100 nT/div)

08 May 1999 (DAY:128)

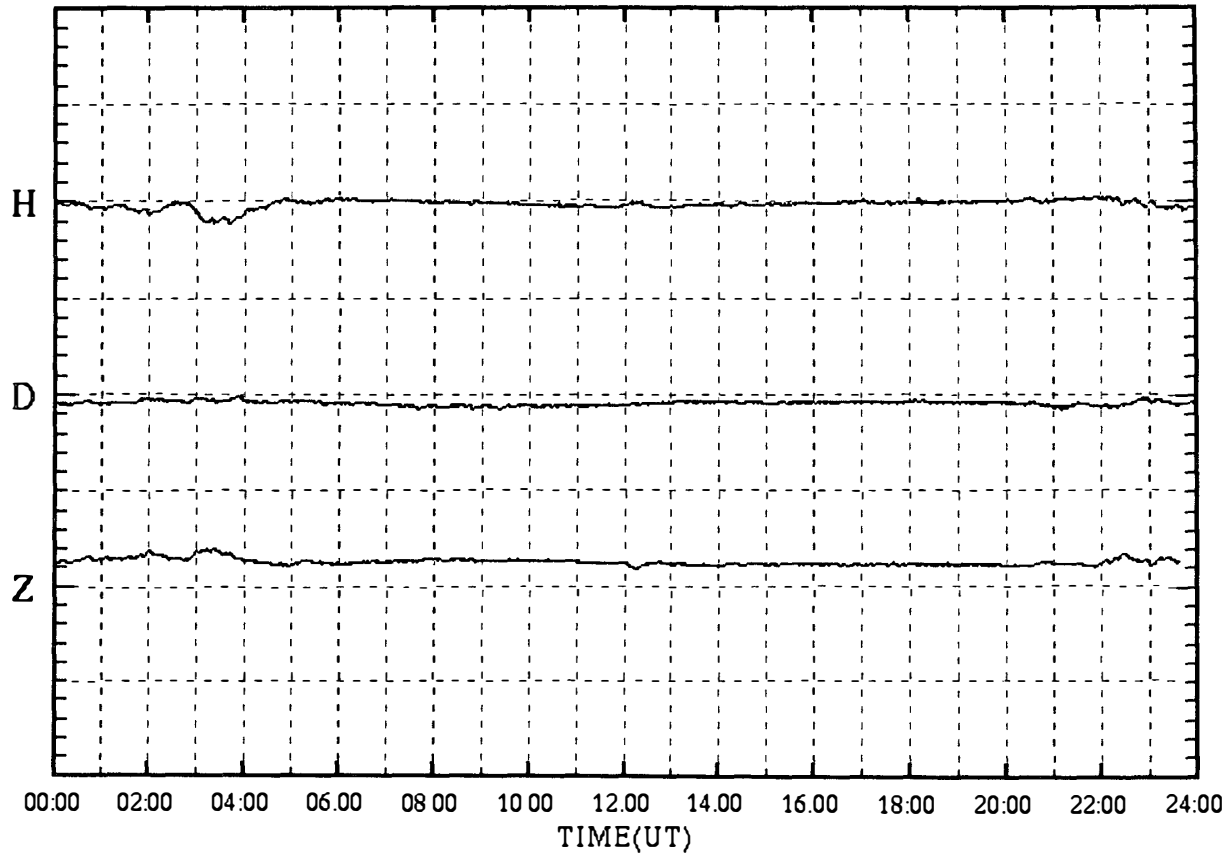



SYOWA magnetogram (100 nT/div)

09 May 1999 (DAY:129)

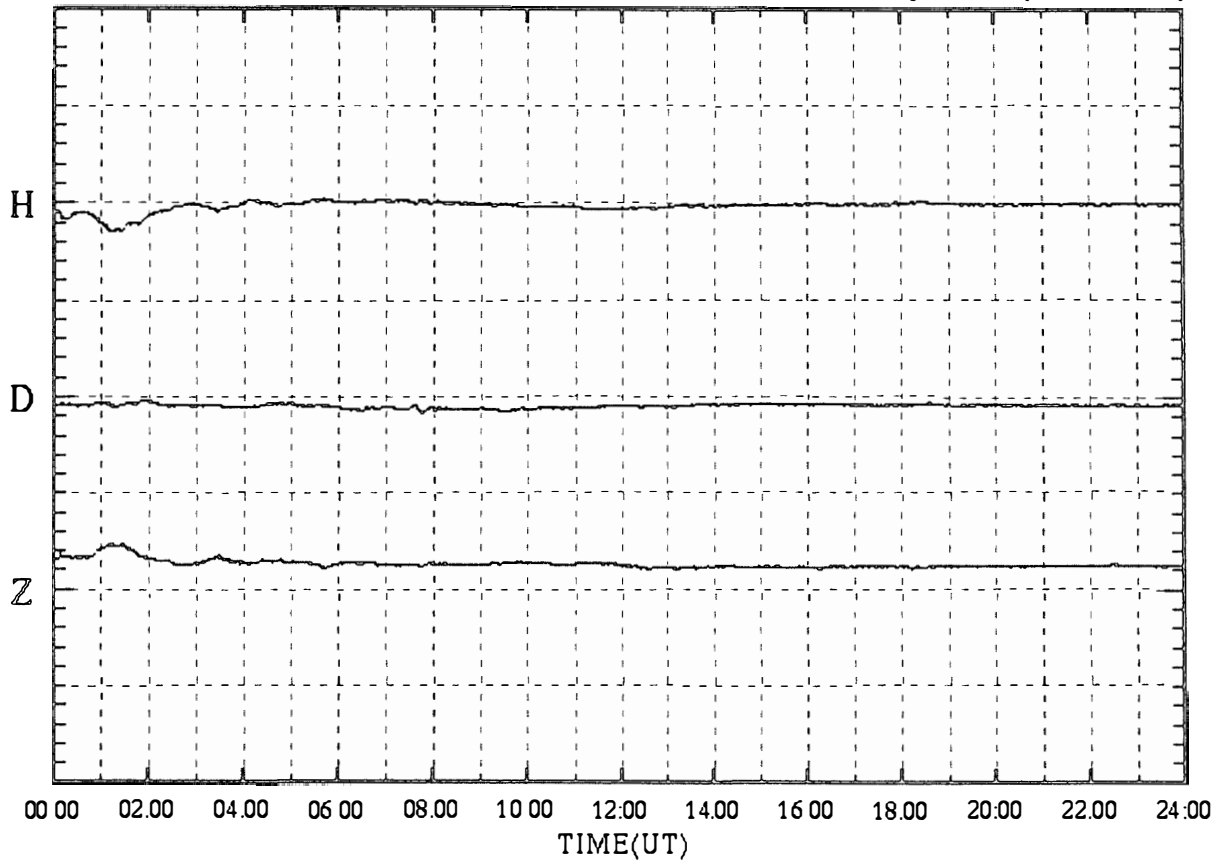

SYOWA magnetogram (100 nT/div)

10 May 1999 (DAY:130)

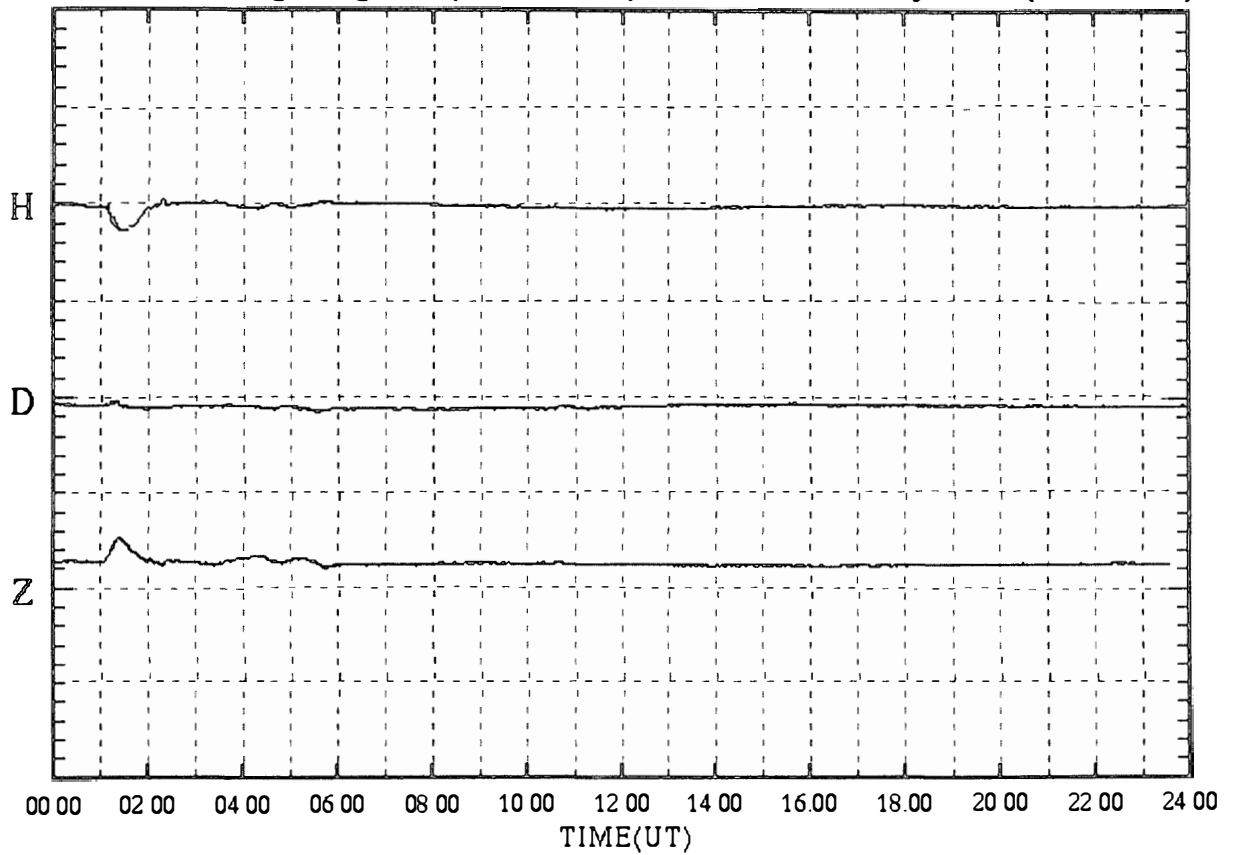

SYOWA magnetogram (100 nT/div)

11 May 1999 (DAY:131)

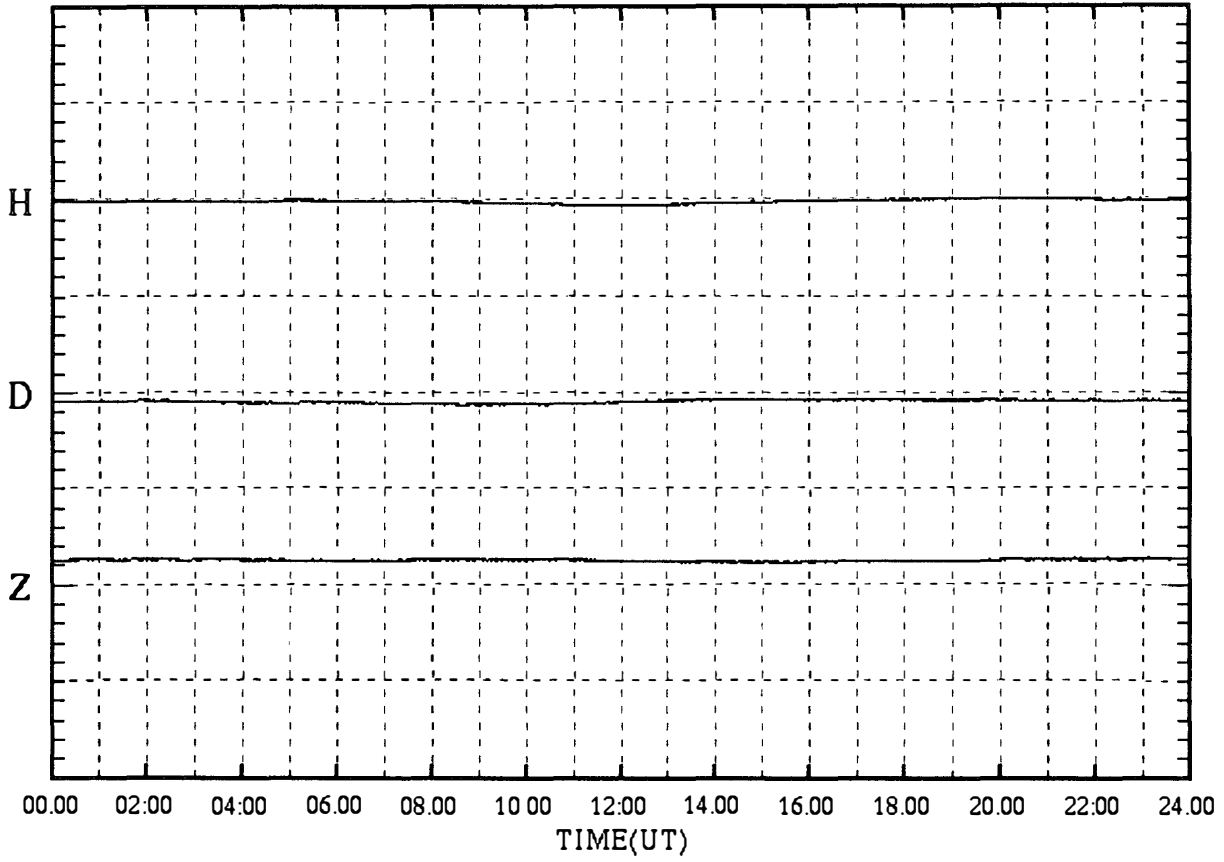

SYOWA magnetogram (100 nT/div)

12 May 1999 (DAY:132)

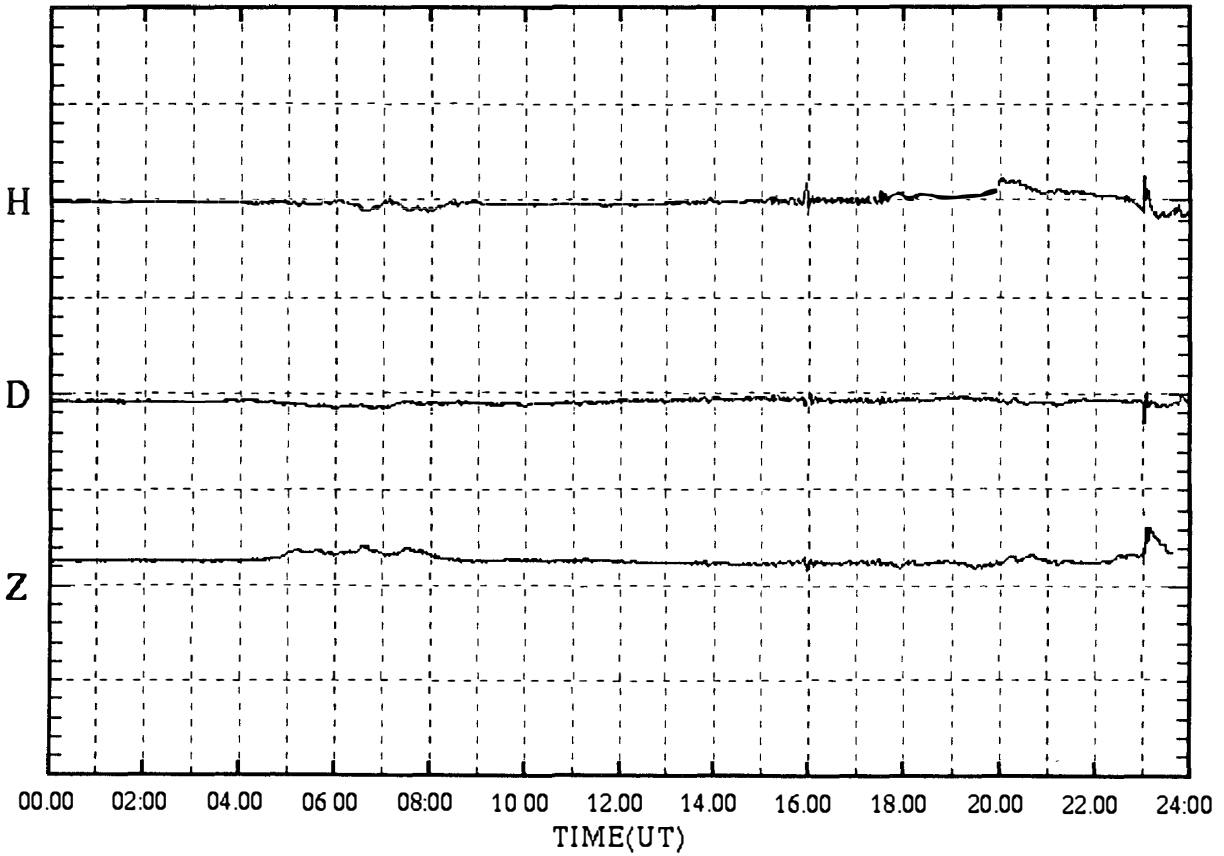

SYOWA magnetogram (100 nT/div)

13 May 1999 (DAY:133)

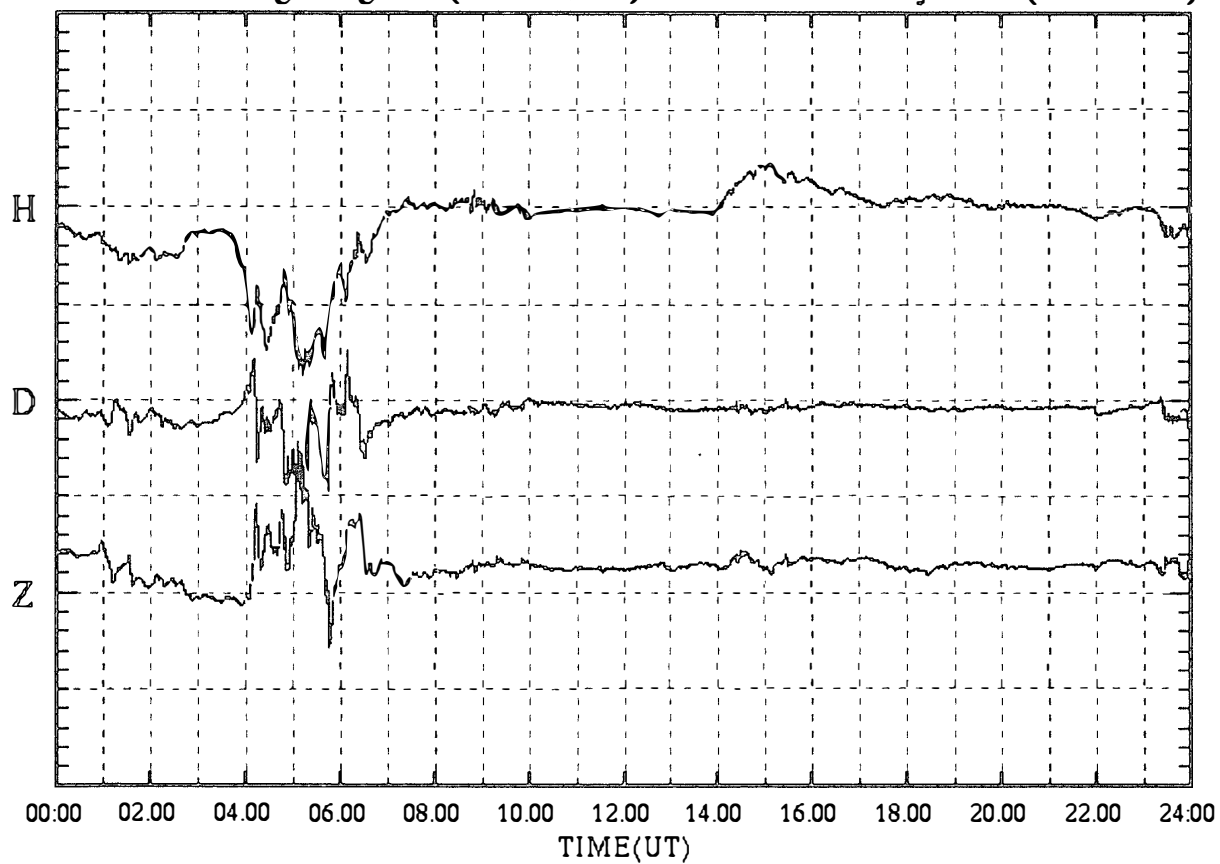

SYOWA magnetogram (100 nT/div)

14 May 1999 (DAY:134)

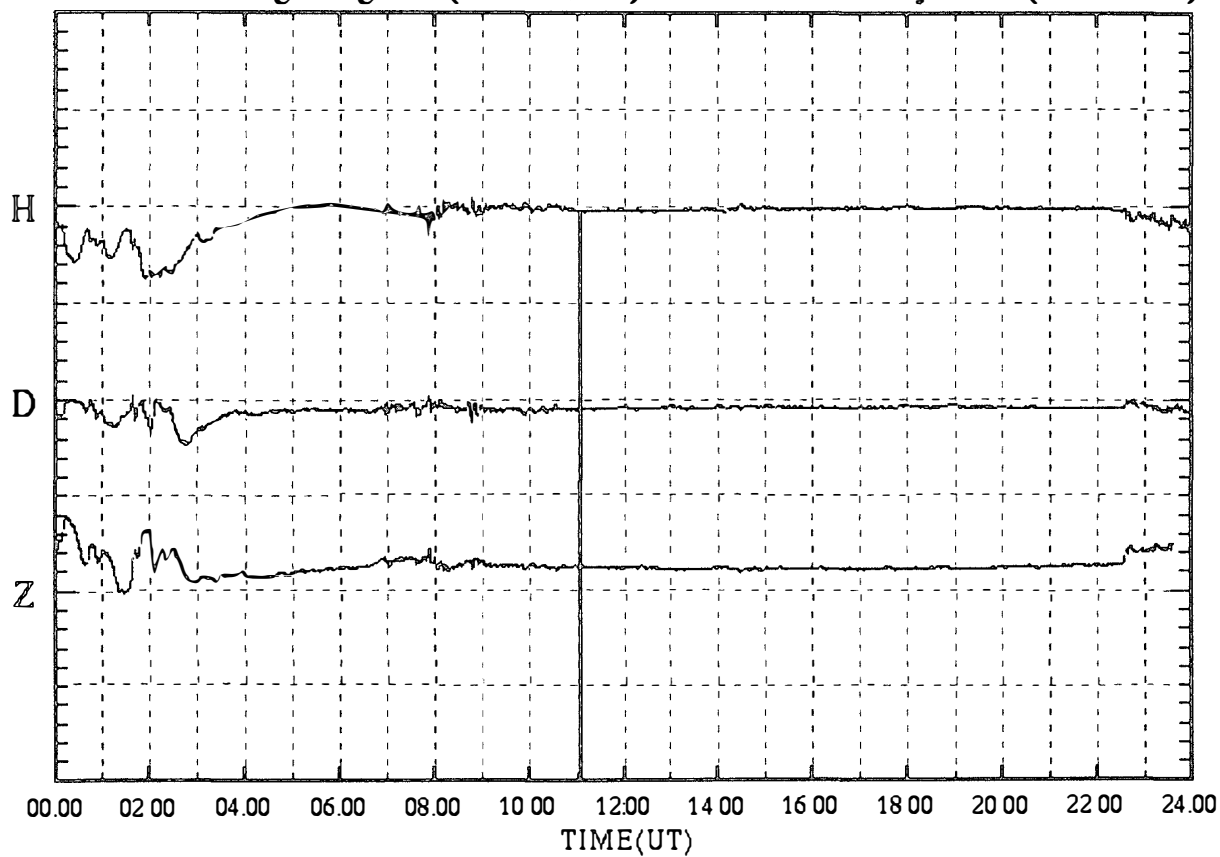

SYOWA magnetogram (100 nT/div)

15 May 1999 (DAY:135)

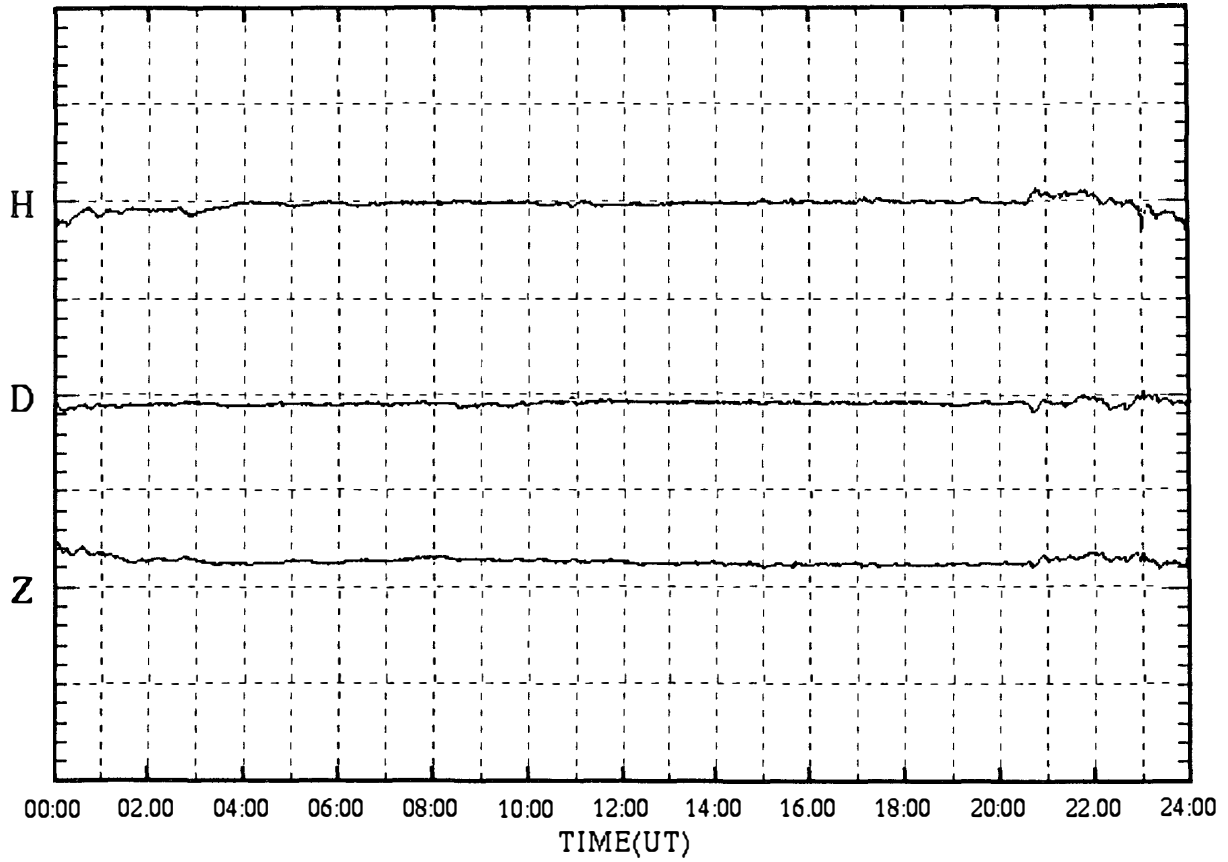

SYOWA magnetogram (100 nT/div)

16 May 1999 (DAY:136)

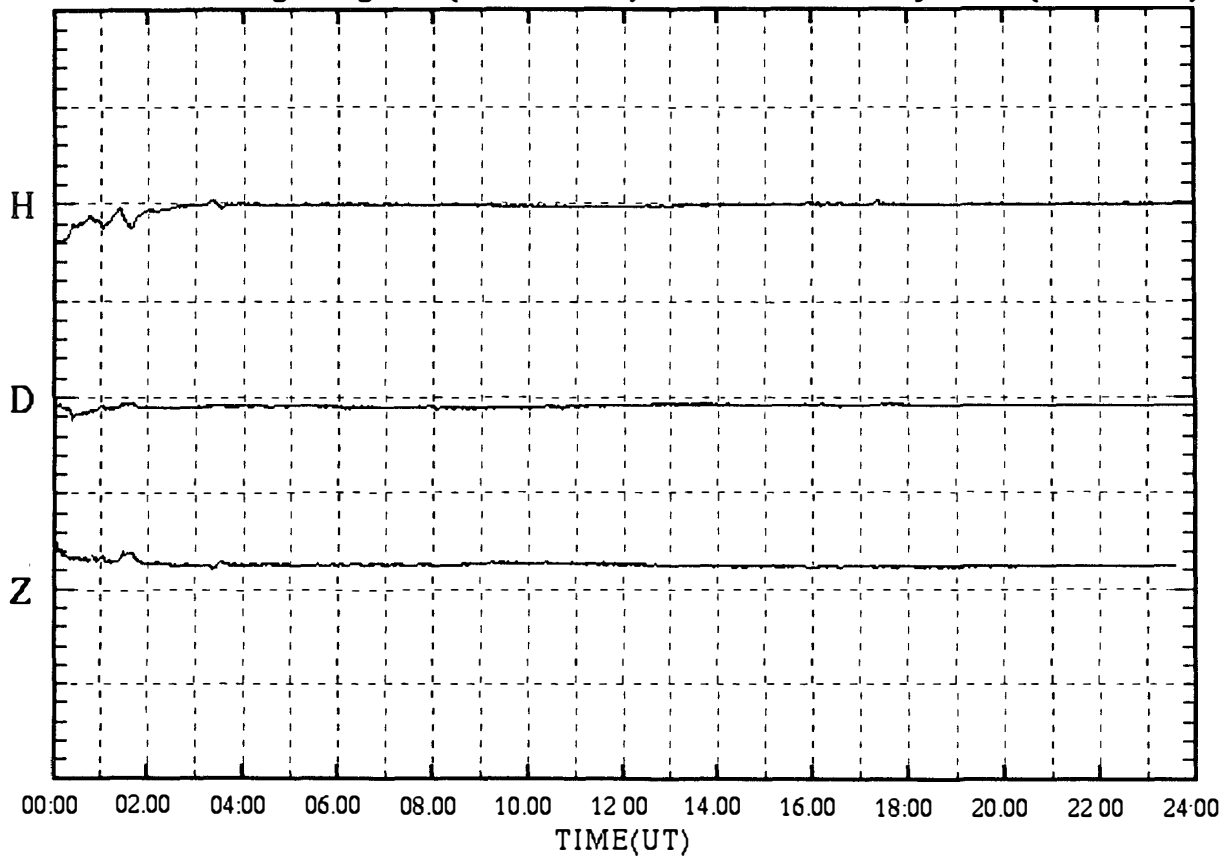

SYOWA magnetogram (100 nT/div)

17 May 1999 (DAY:137)

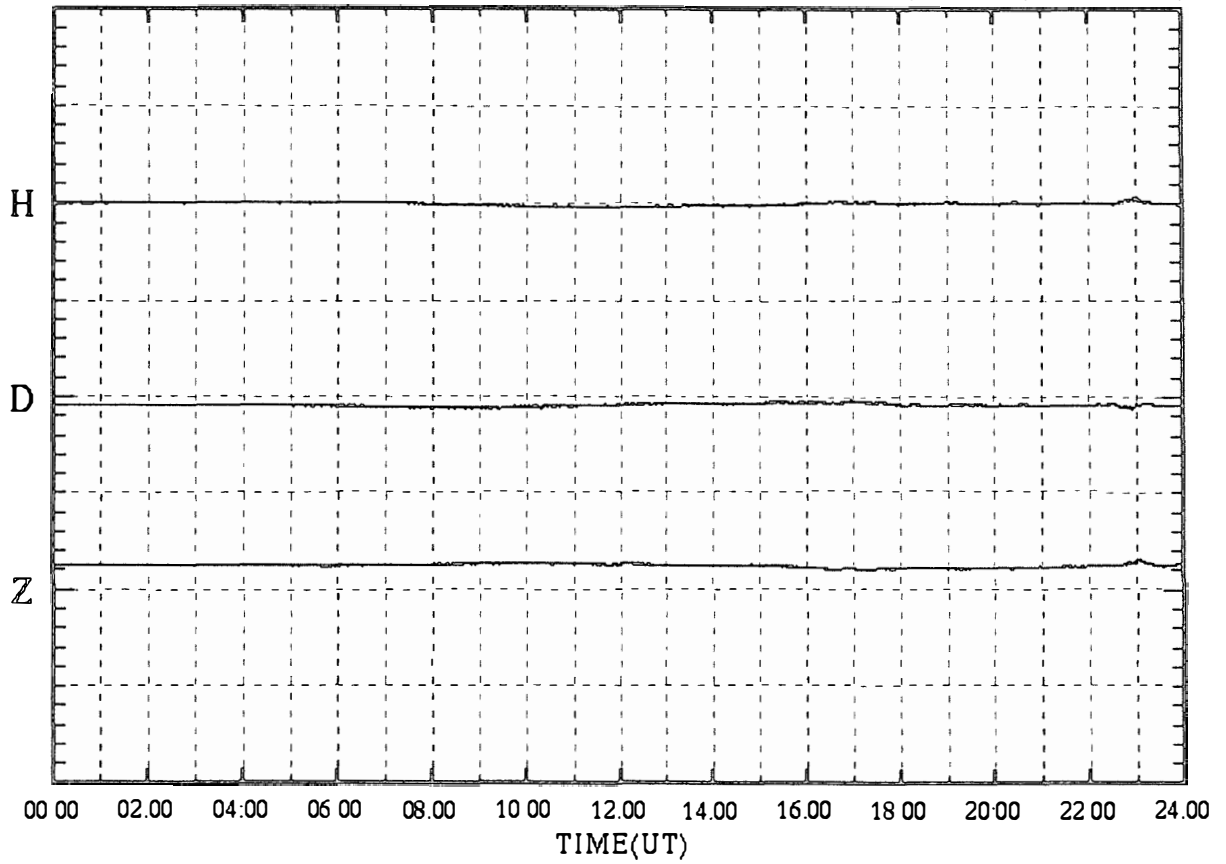

SYOWA magnetogram (100 nT/div)

18 May 1999 (DAY:138)

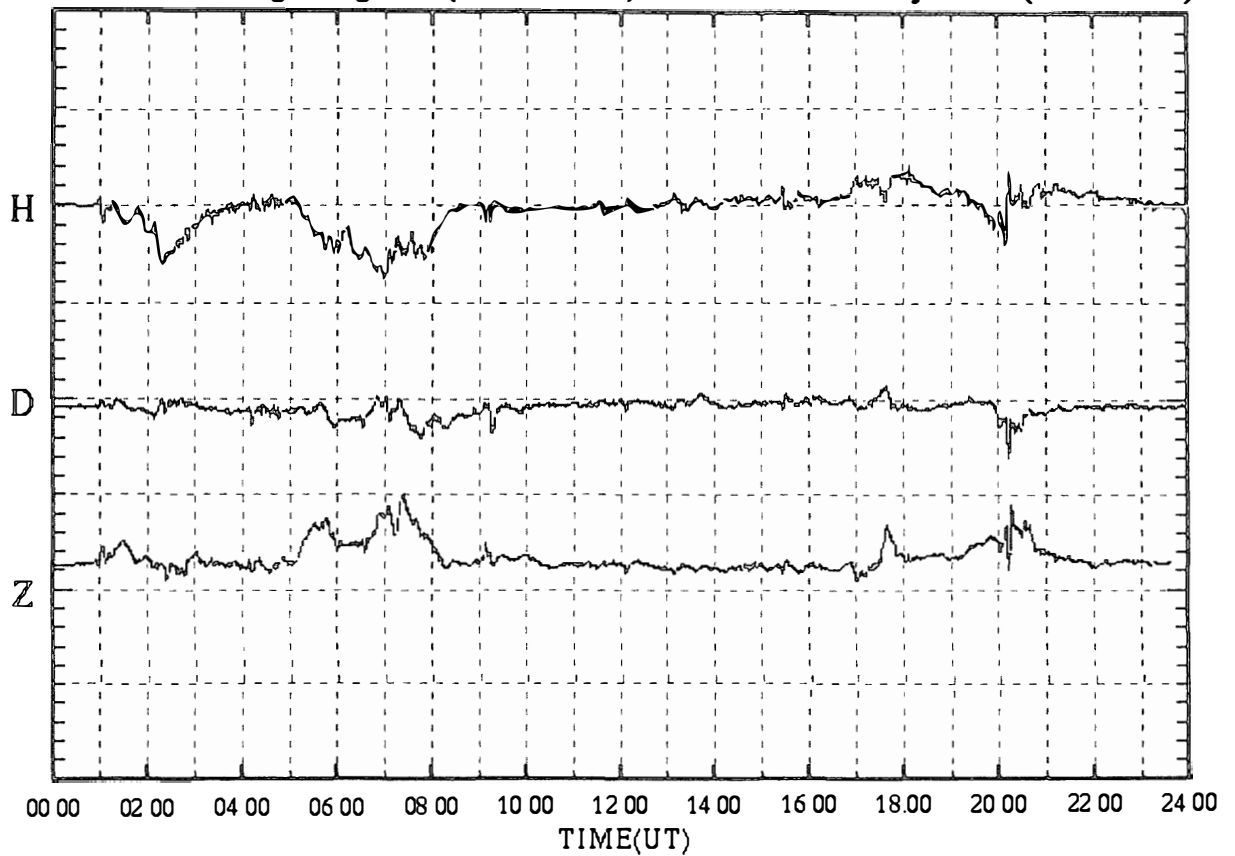

SYOWA magnetogram (100 nT/div)

19 May 1999 (DAY:139)

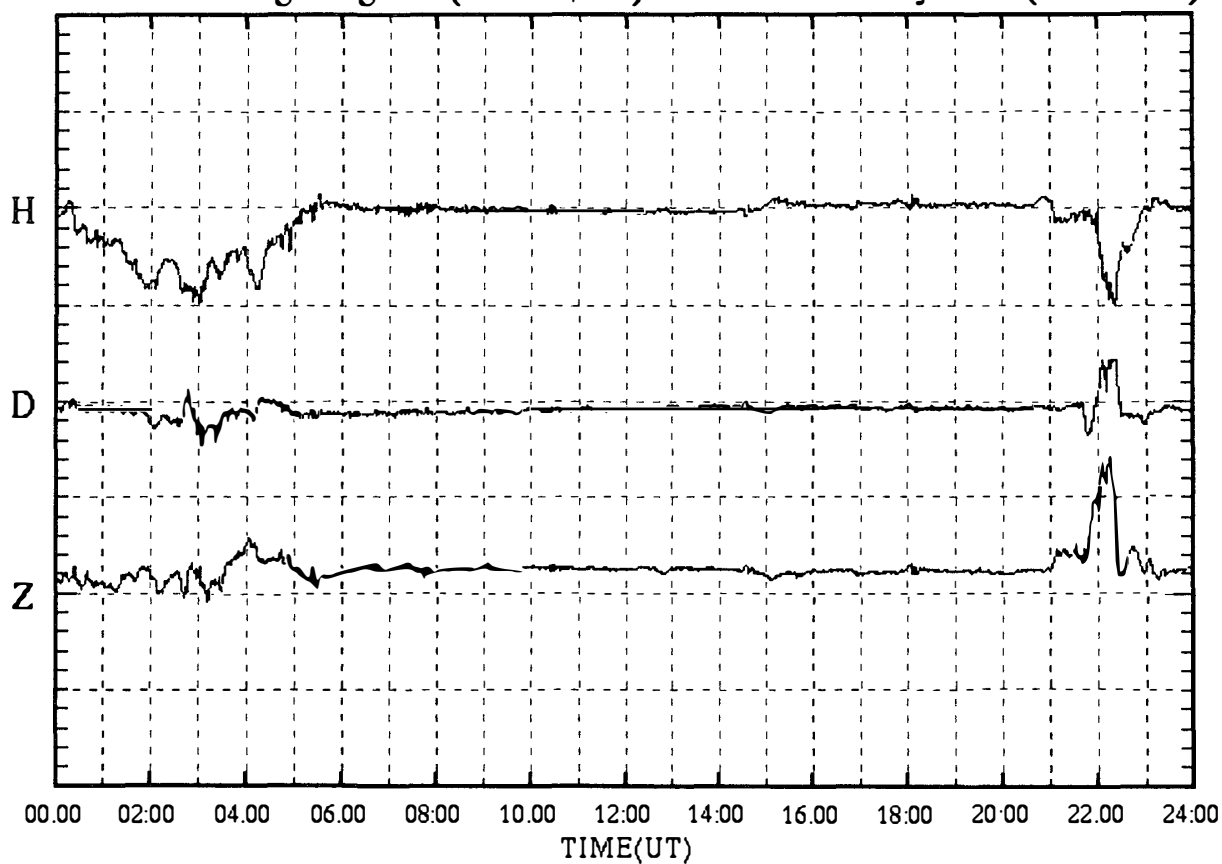

SYOWA magnetogram (100 nT/div)

20 May 1999 (DAY:140)

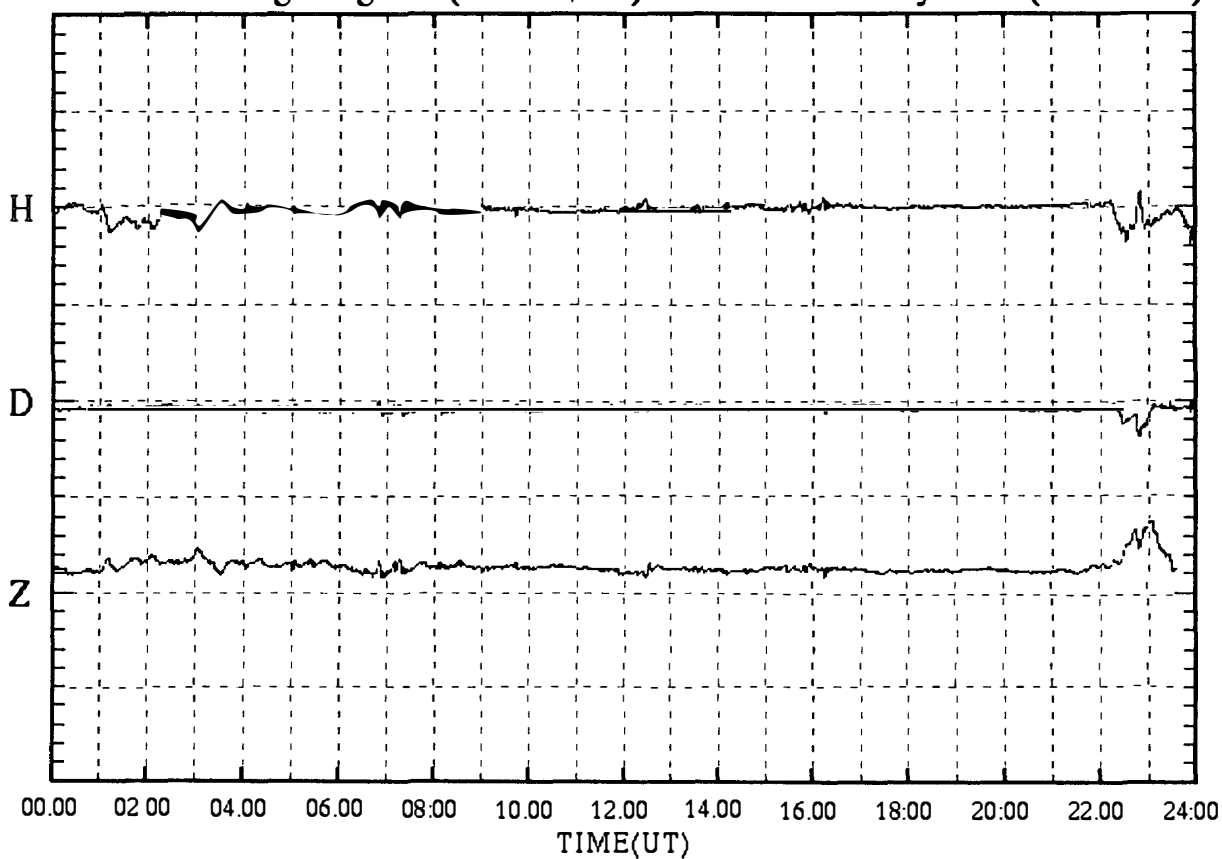

SYOWA magnetogram (100 nT/div)

21 May 1999 (DAY:141)

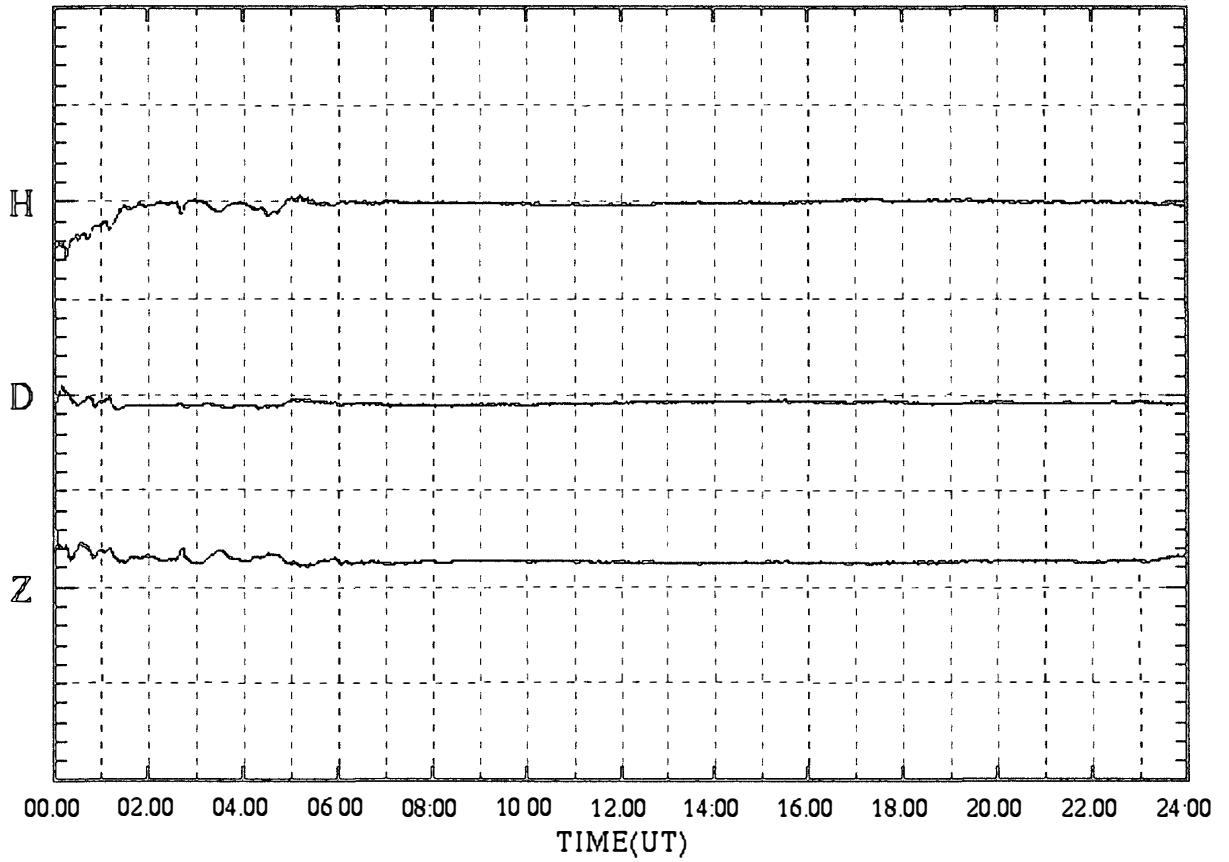

SYOWA magnetogram (100 nT/div)

22 May 1999 (DAY:142)

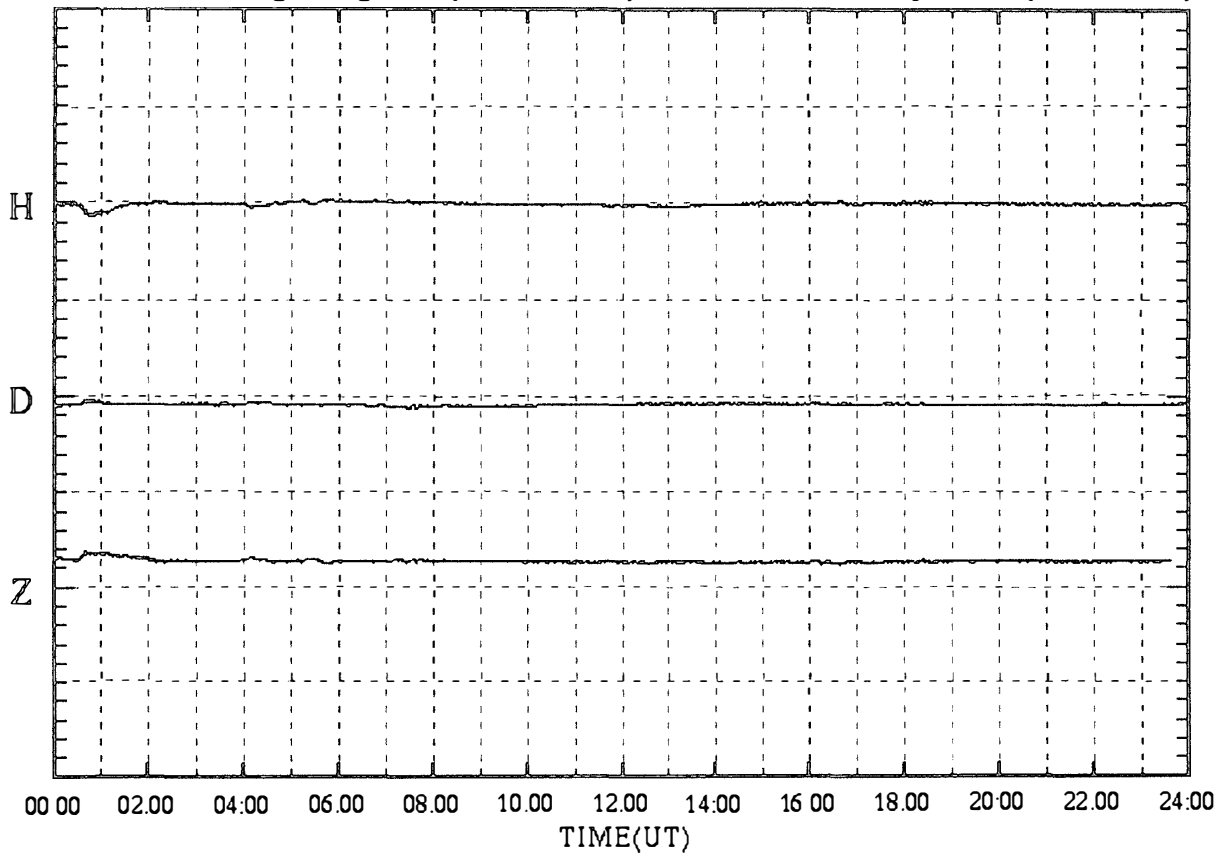

SYOWA magnetogram (100 nT/div)

23 May 1999 (DAY:143)

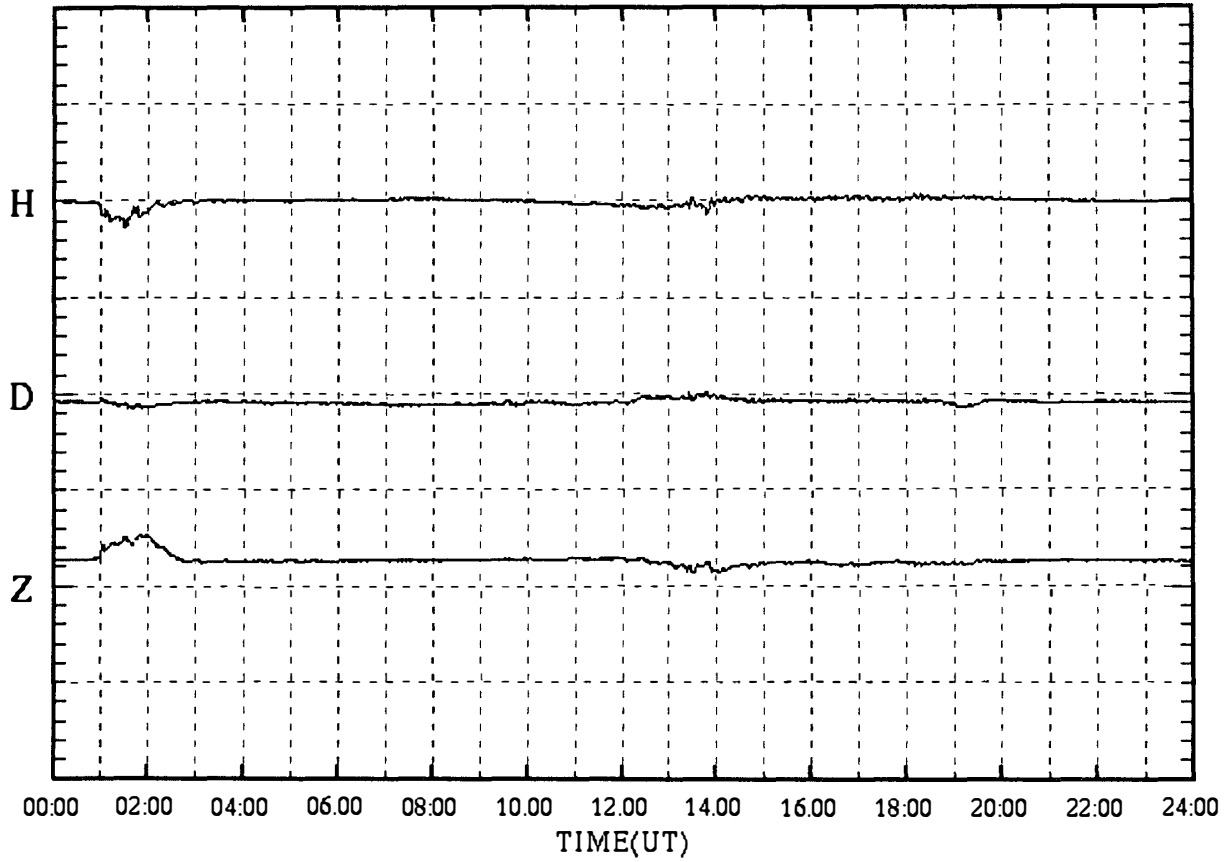

SYOWA magnetogram (100 nT/div)

24 May 1999 (DAY:144)

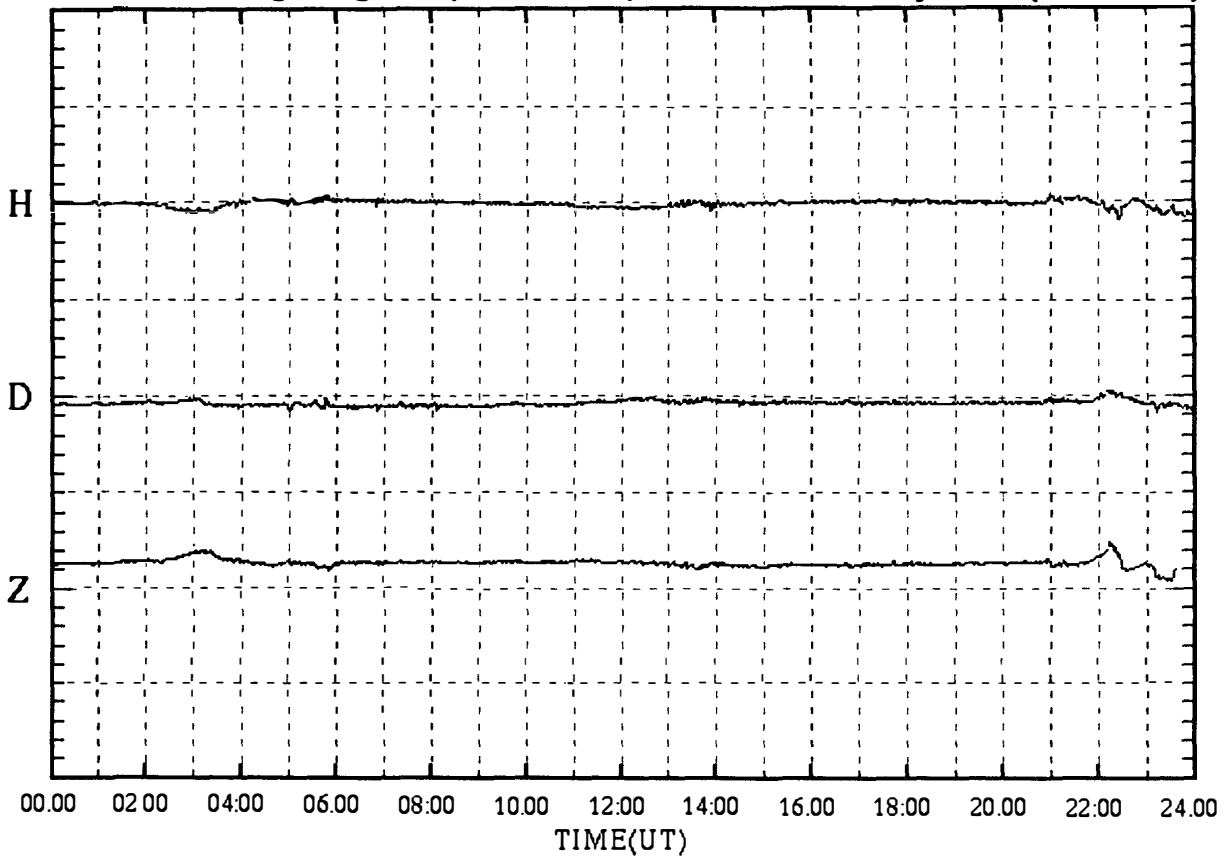



SYOWA magnetogram (100 nT/div)

25 May 1999 (DAY:145)

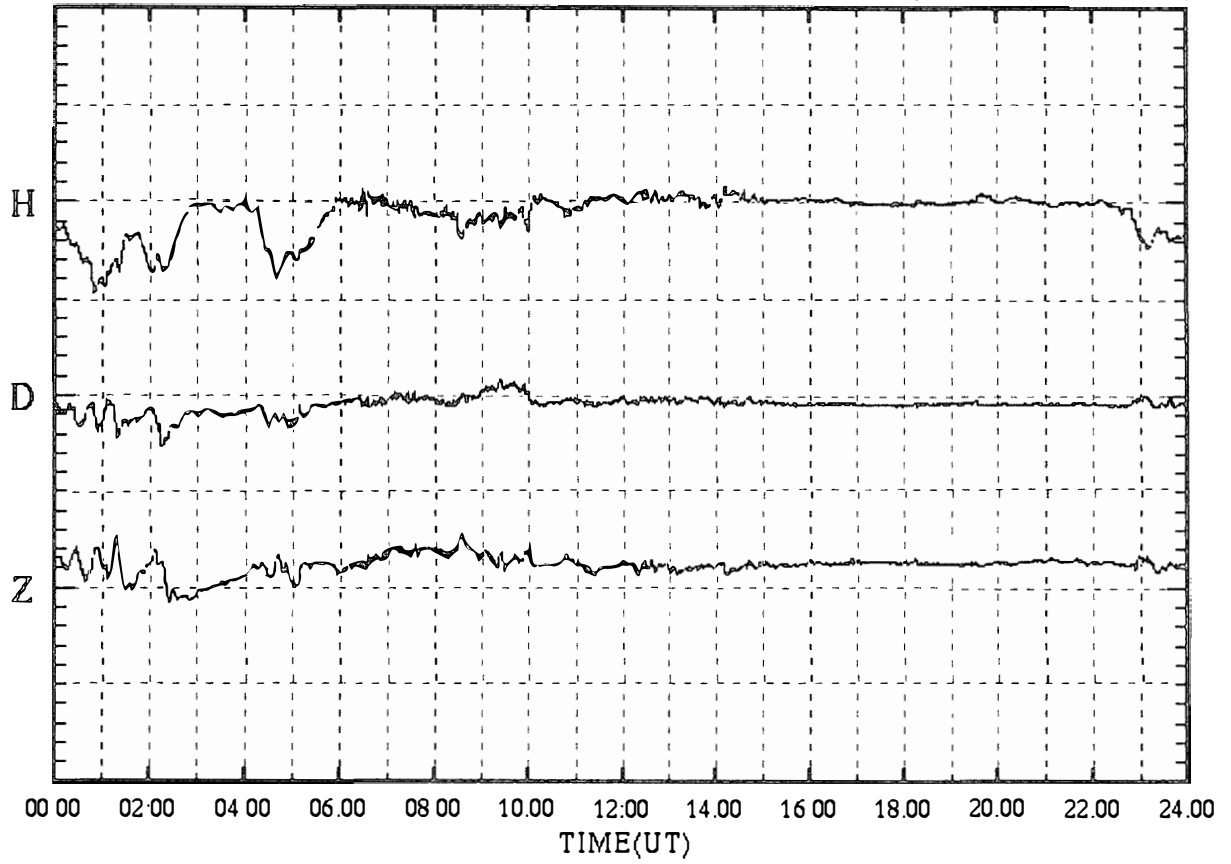

SYOWA magnetogram (100 nT/div)

26 May 1999 (DAY:146)

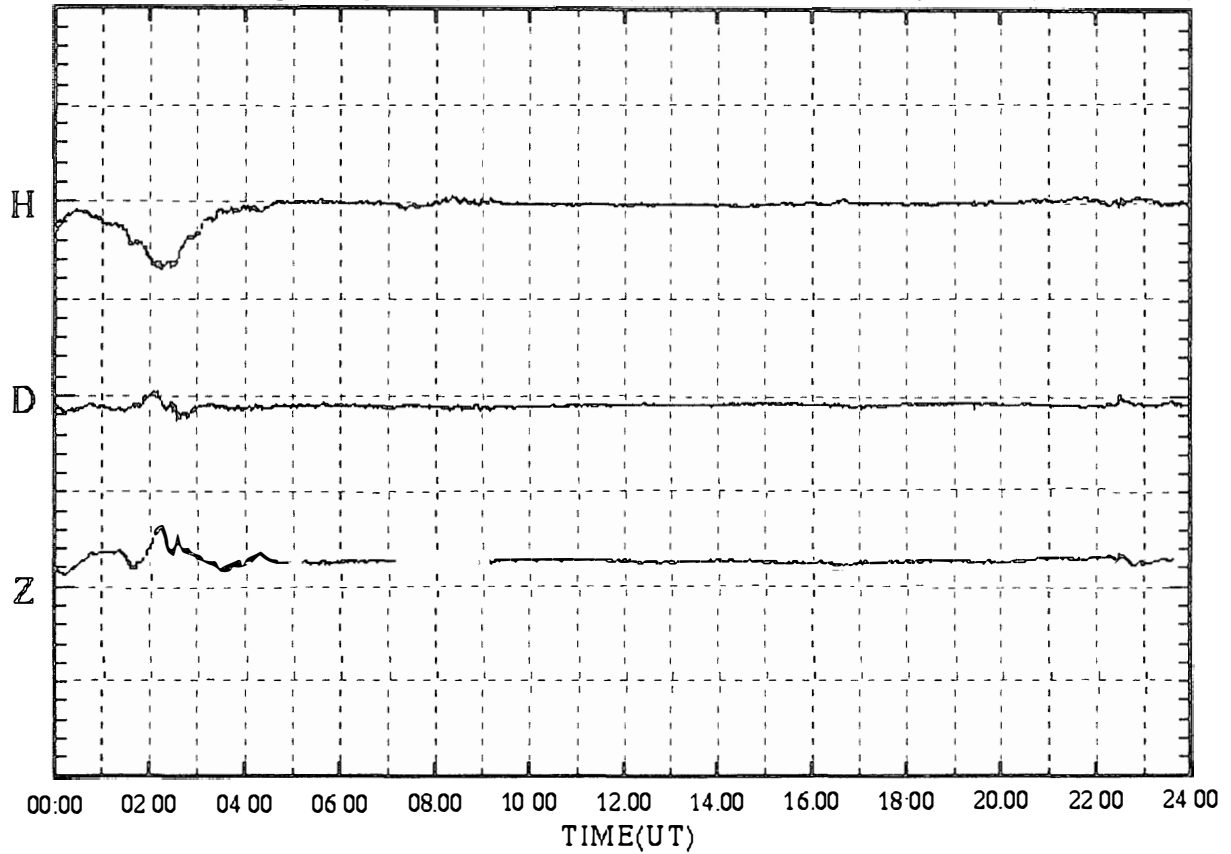

SYOWA magnetogram (100 nT/div)

27 May 1999 (DAY:147)

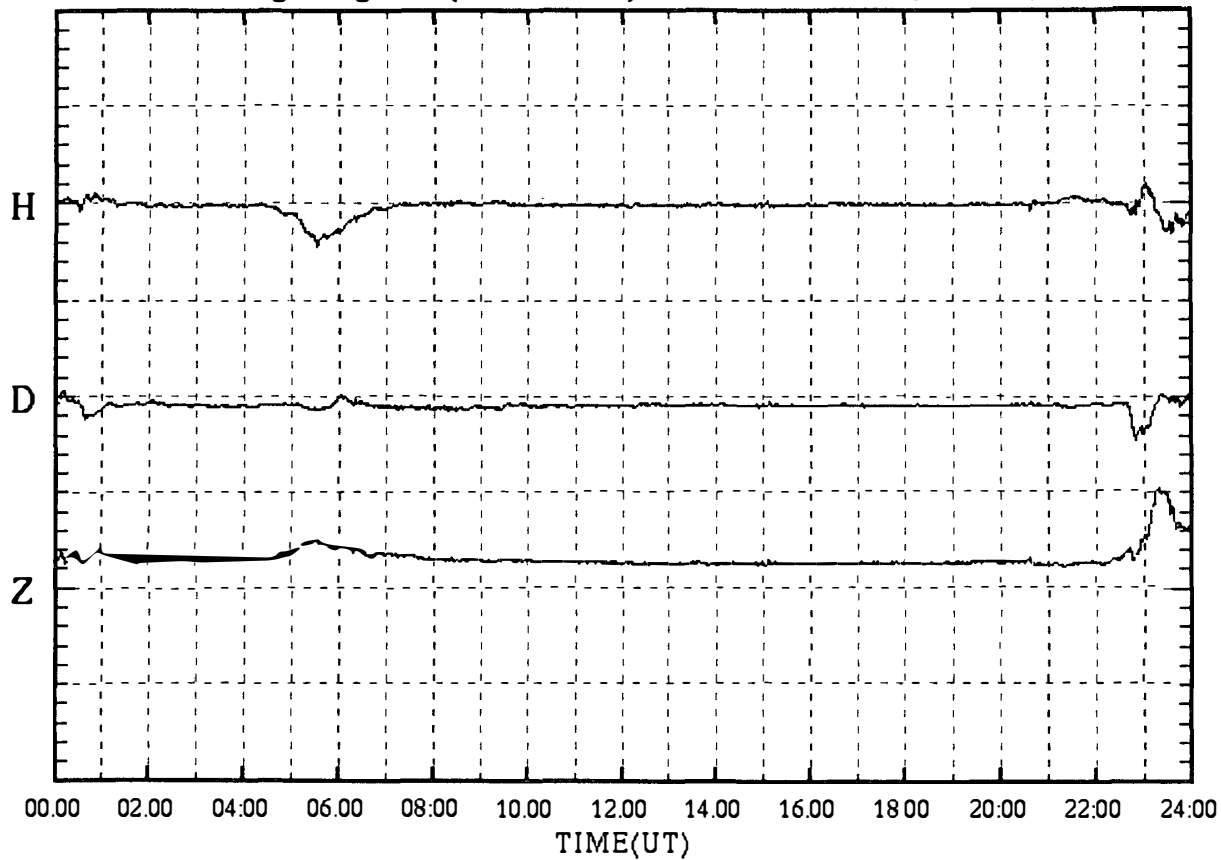

SYOWA magnetogram (100 nT/div)

28 May 1999 (DAY:148)

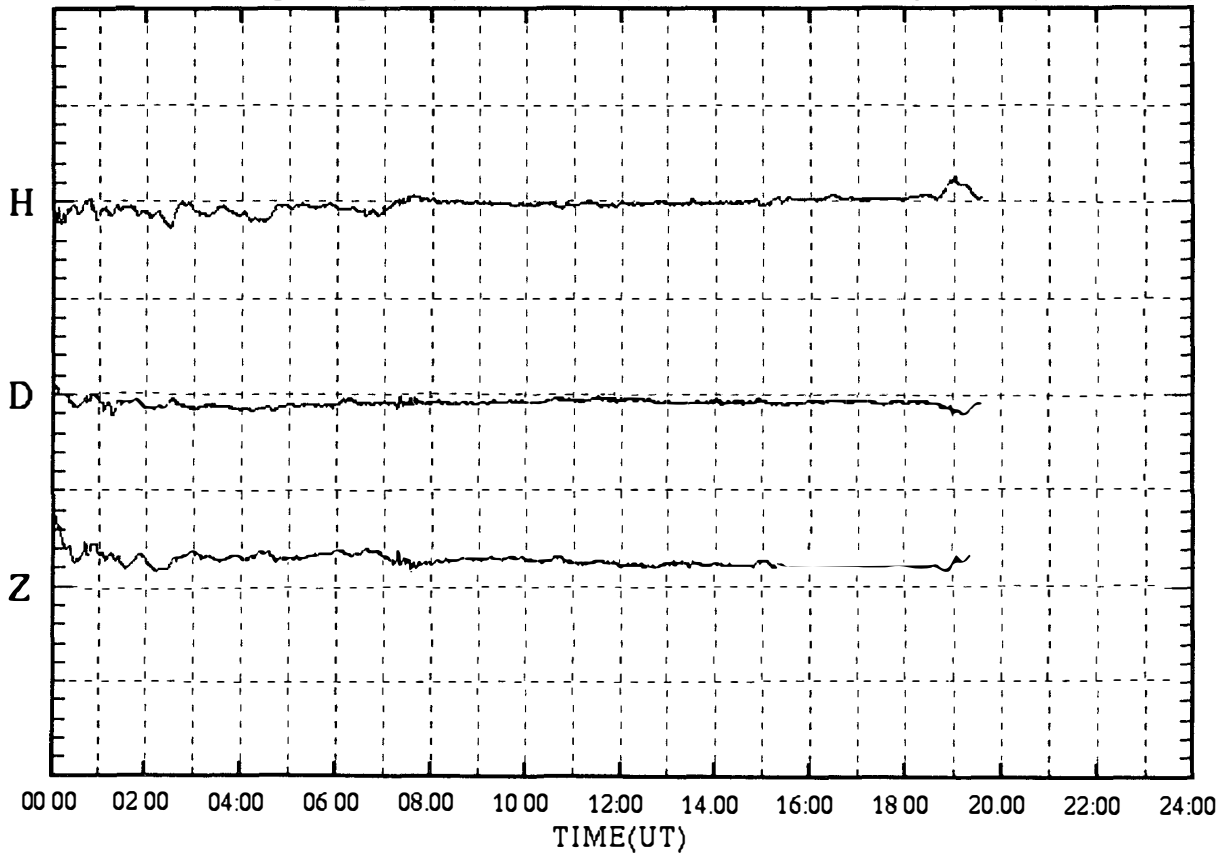

SYOWA magnetogram (100 nT/div)

29 May 1999 (DAY:149)

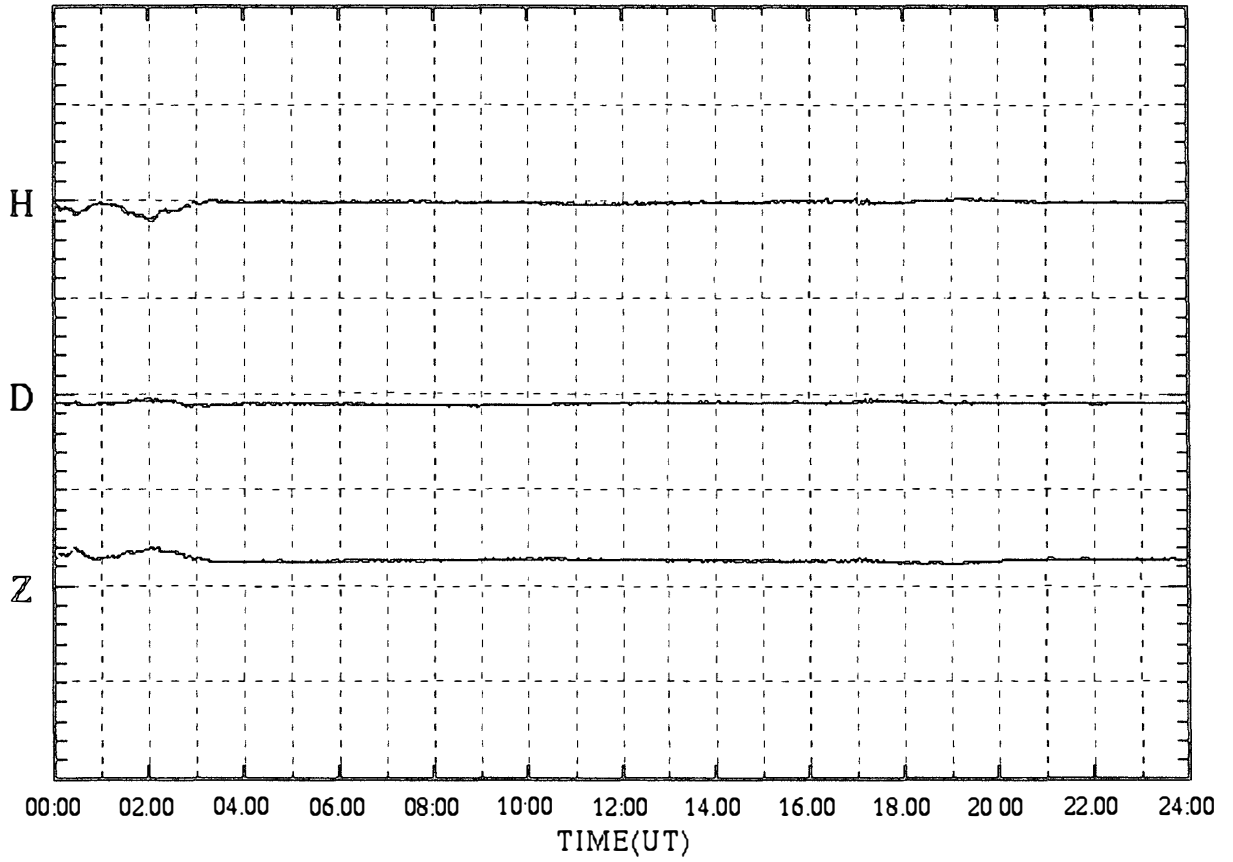

SYOWA magnetogram (100 nT/div)

30 May 1999 (DAY:150)

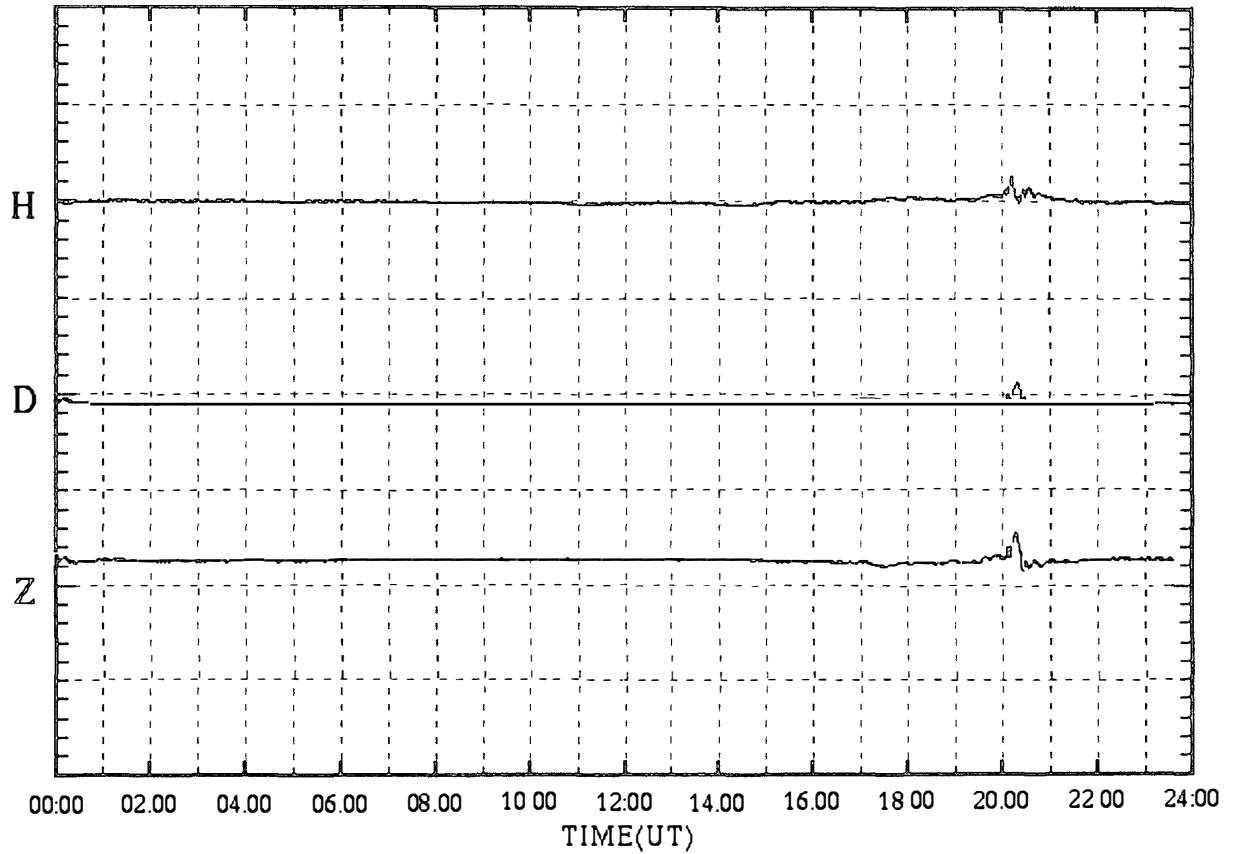

SYOWA magnetogram (100 nT/div)

31 May 1999 (DAY:151)

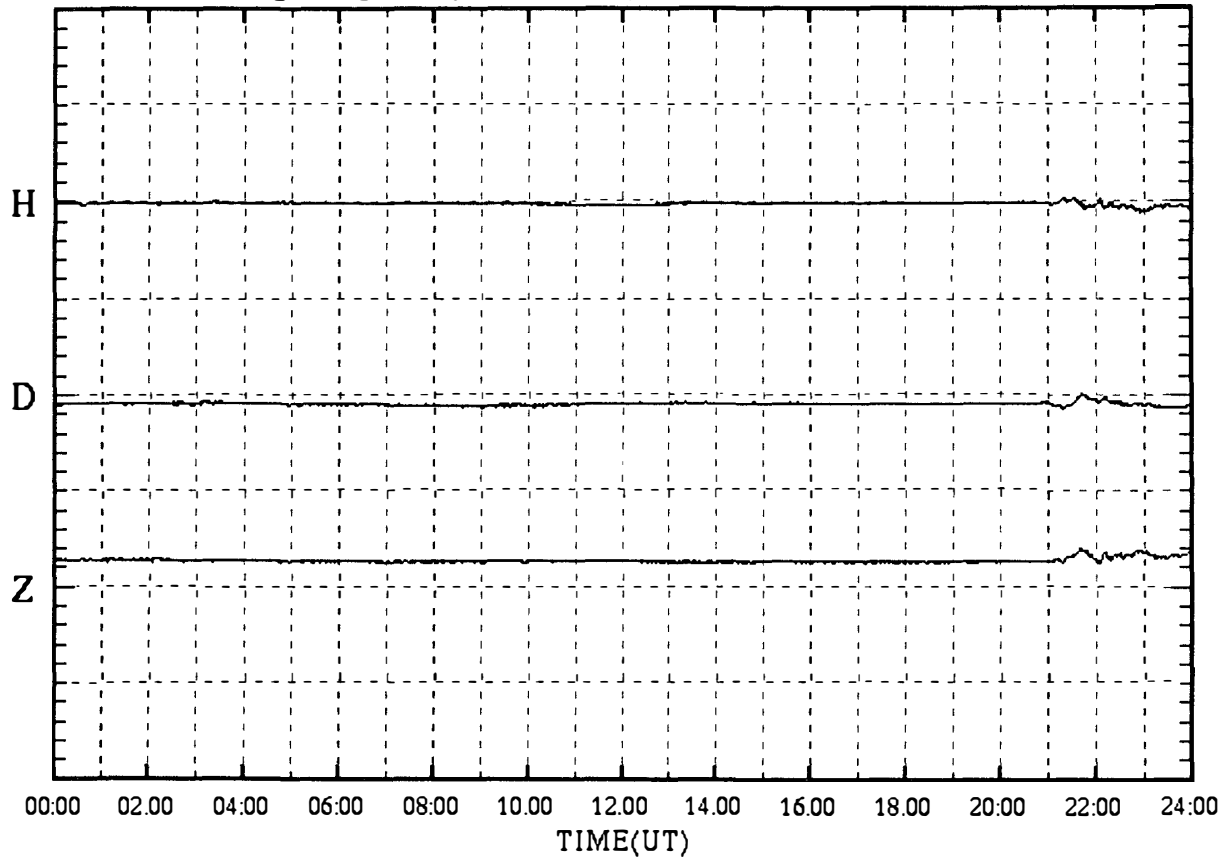

SYOWA magnetogram (100 nT/div)

01 Jun.1999 (DAY:152)

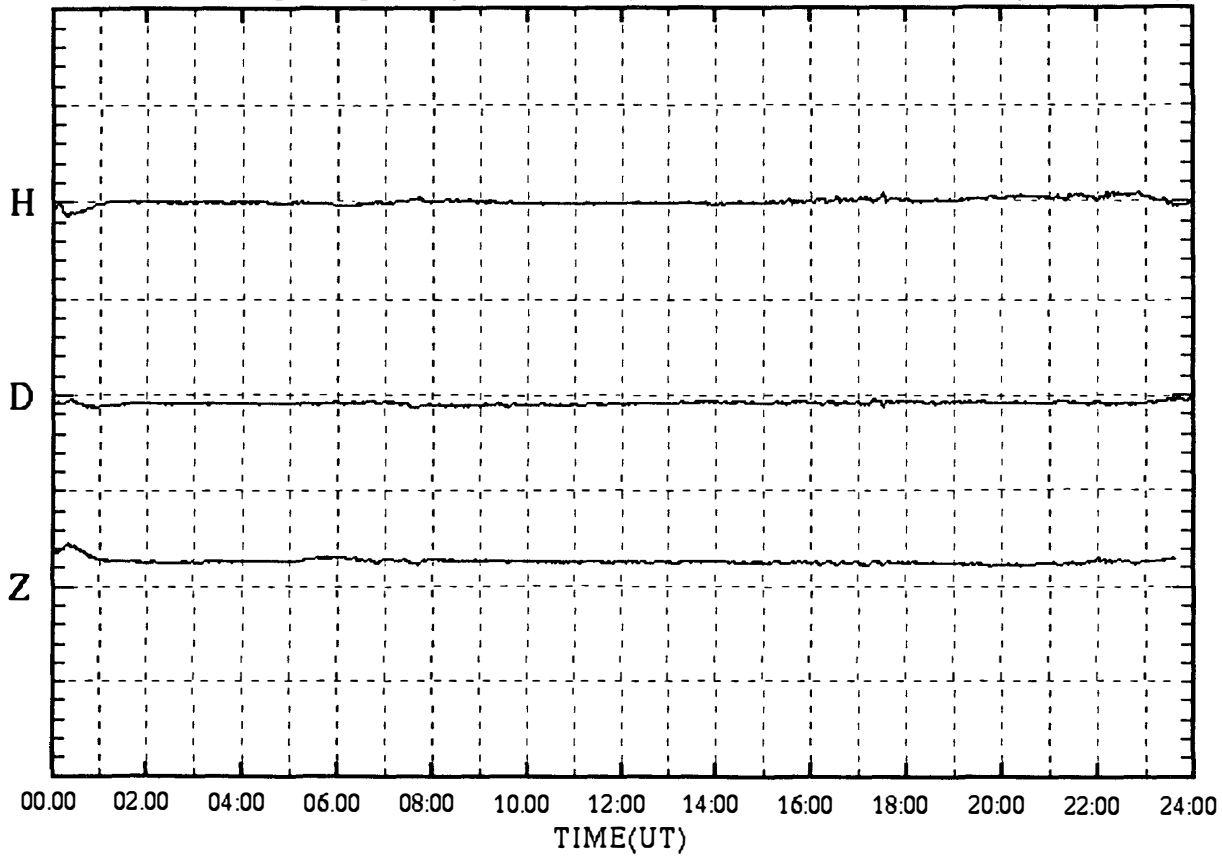

SYOWA magnetogram (100 nT/div)

02 Jun.1999 (DAY:153)

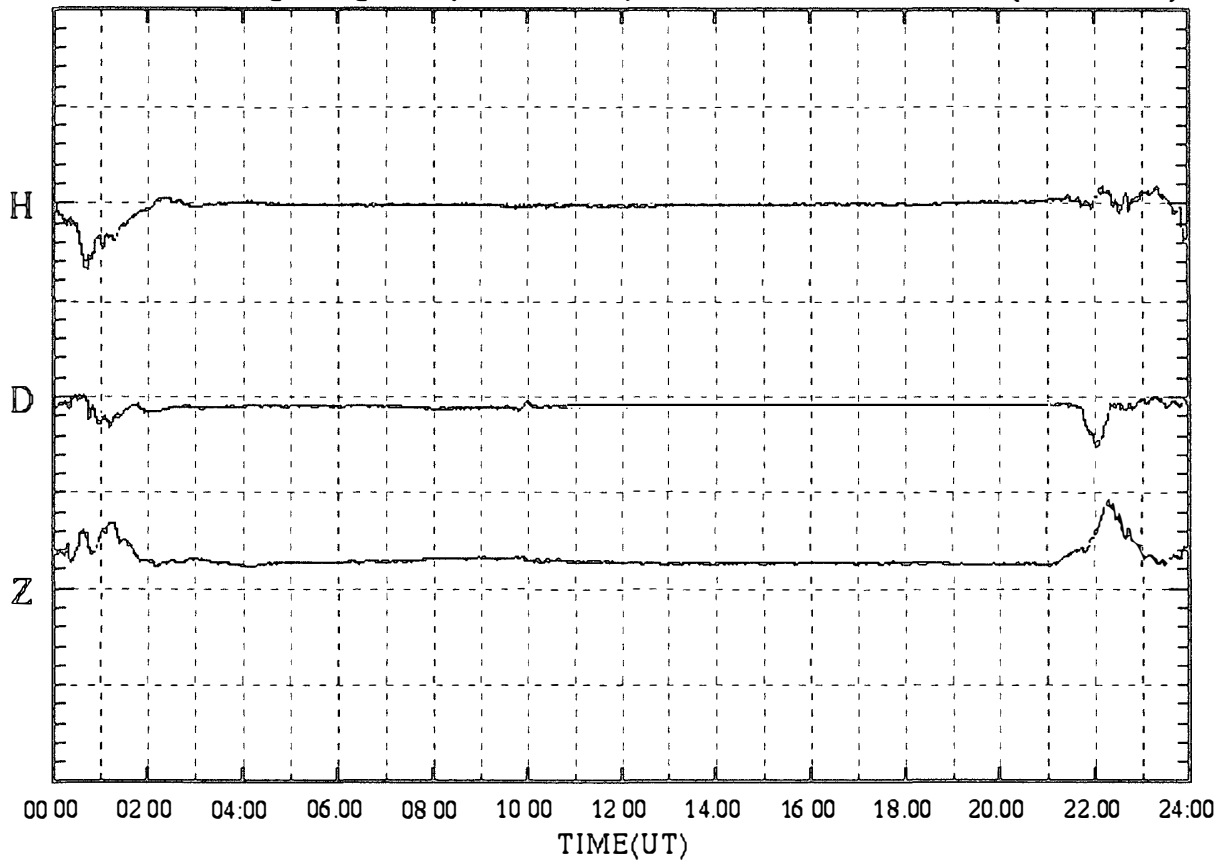

SYOWA magnetogram (100 nT/div)

03 Jun.1999 (DAY:154)

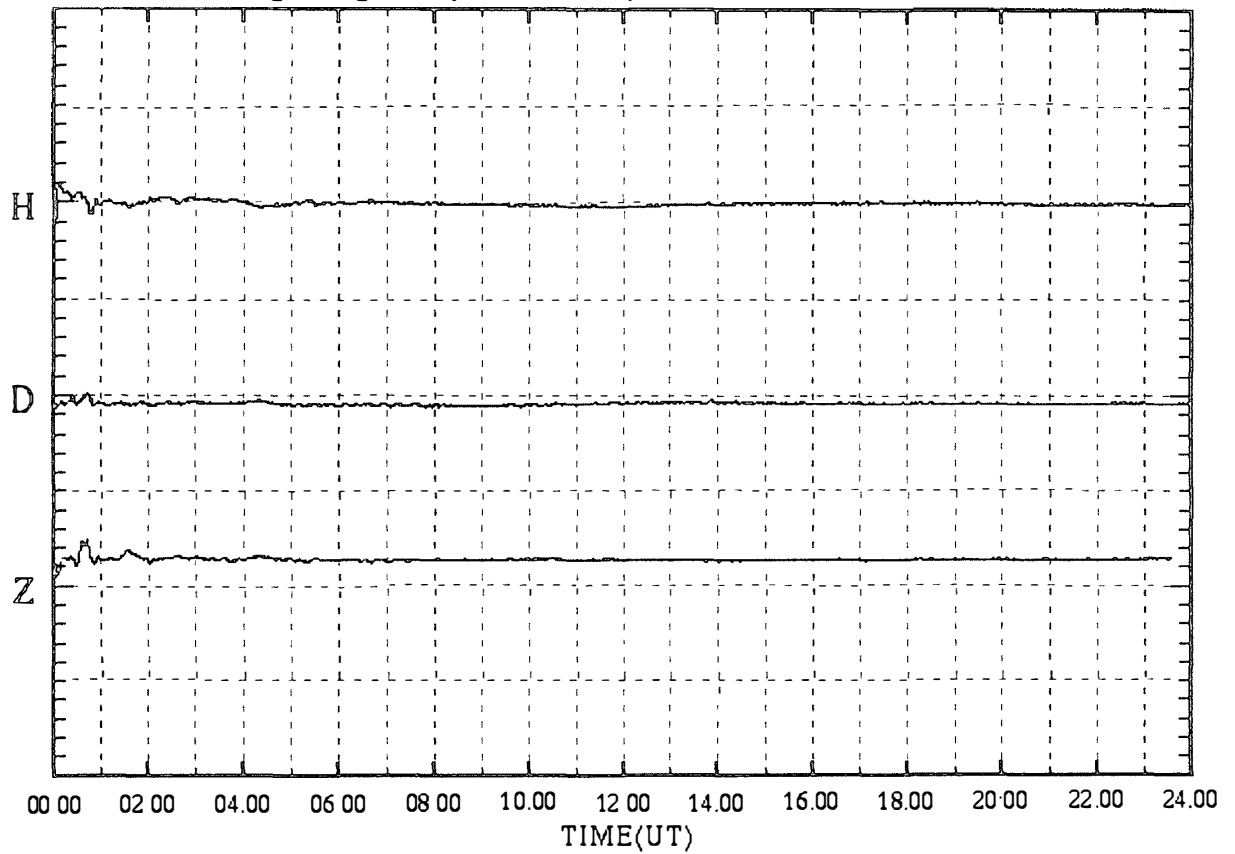

SYOWA magnetogram (100 nT/div)

04 Jun.1999 (DAY:155)

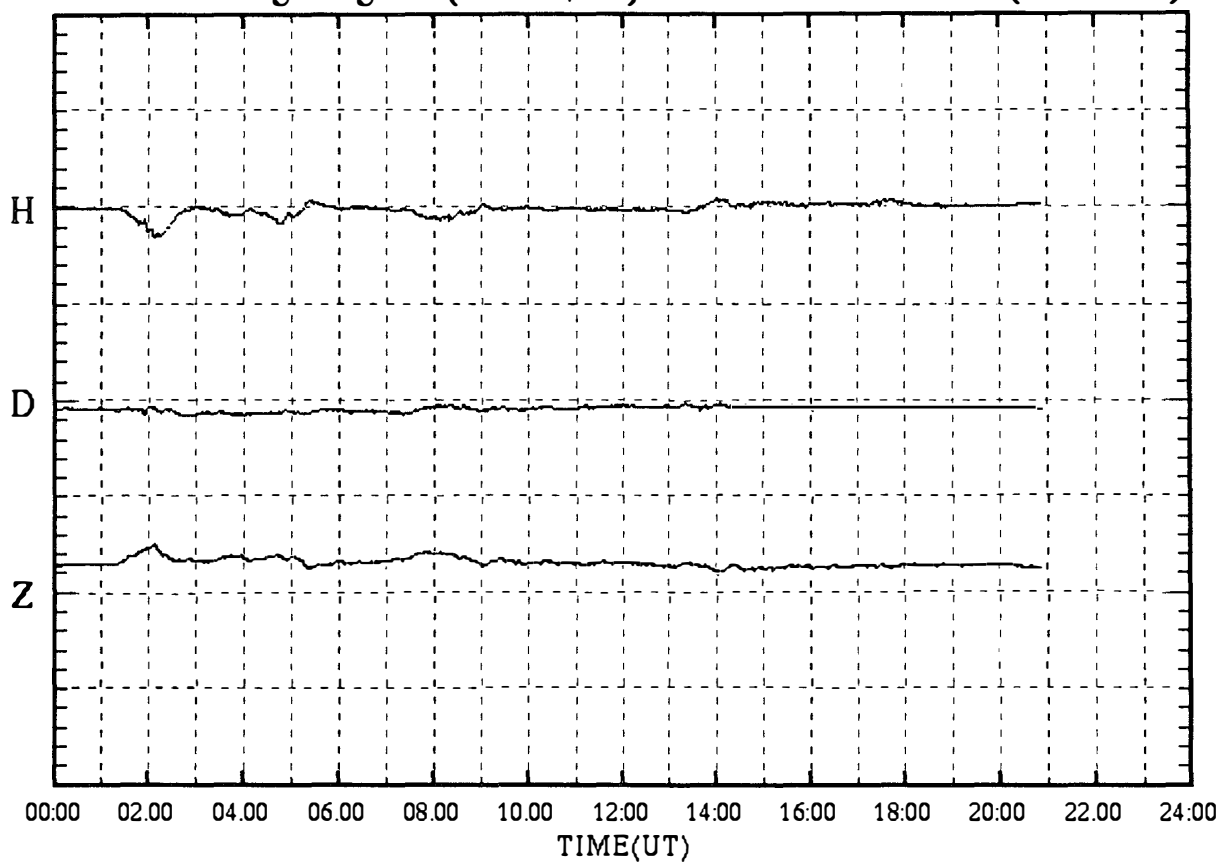

SYOWA magnetogram (100 nT/div)

05 Jun.1999 (DAY:156)

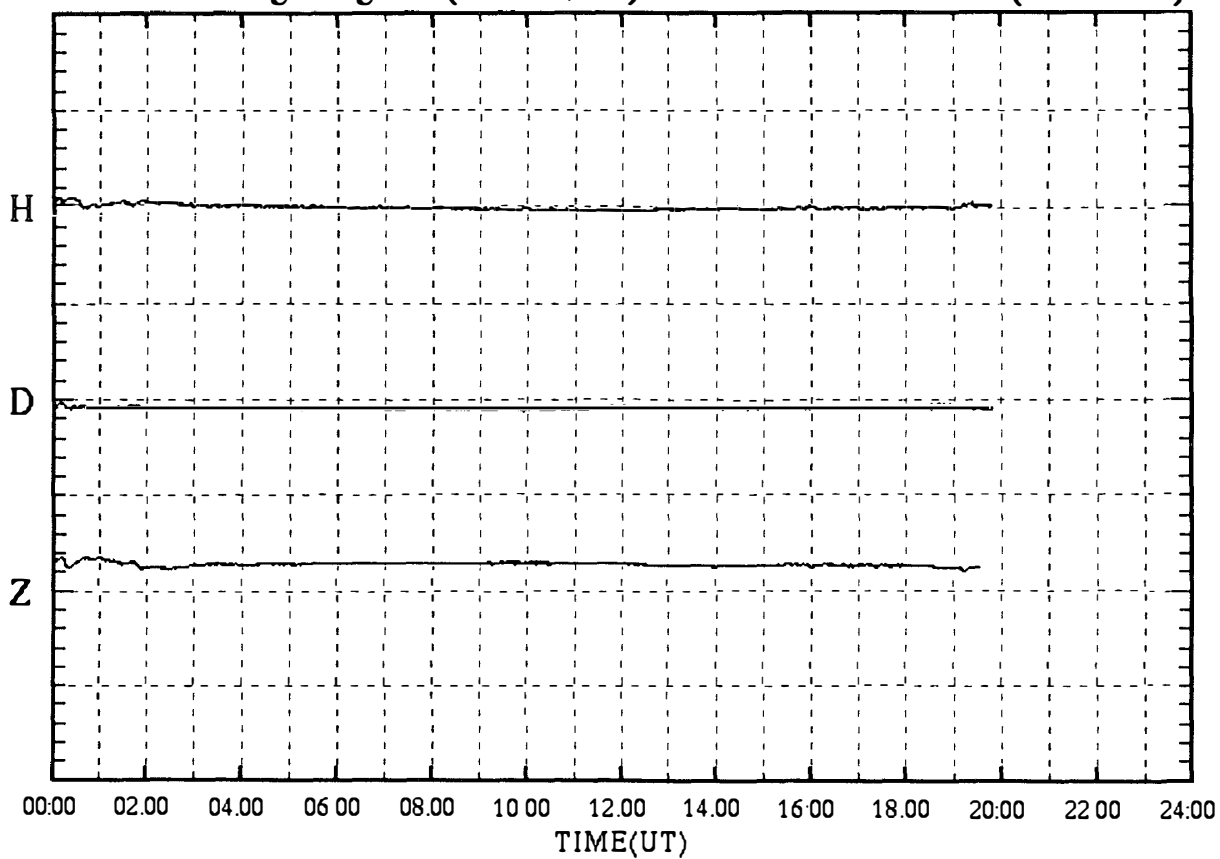

SYOWA magnetogram (100 nT/div)

06 Jun.1999 (DAY:157)

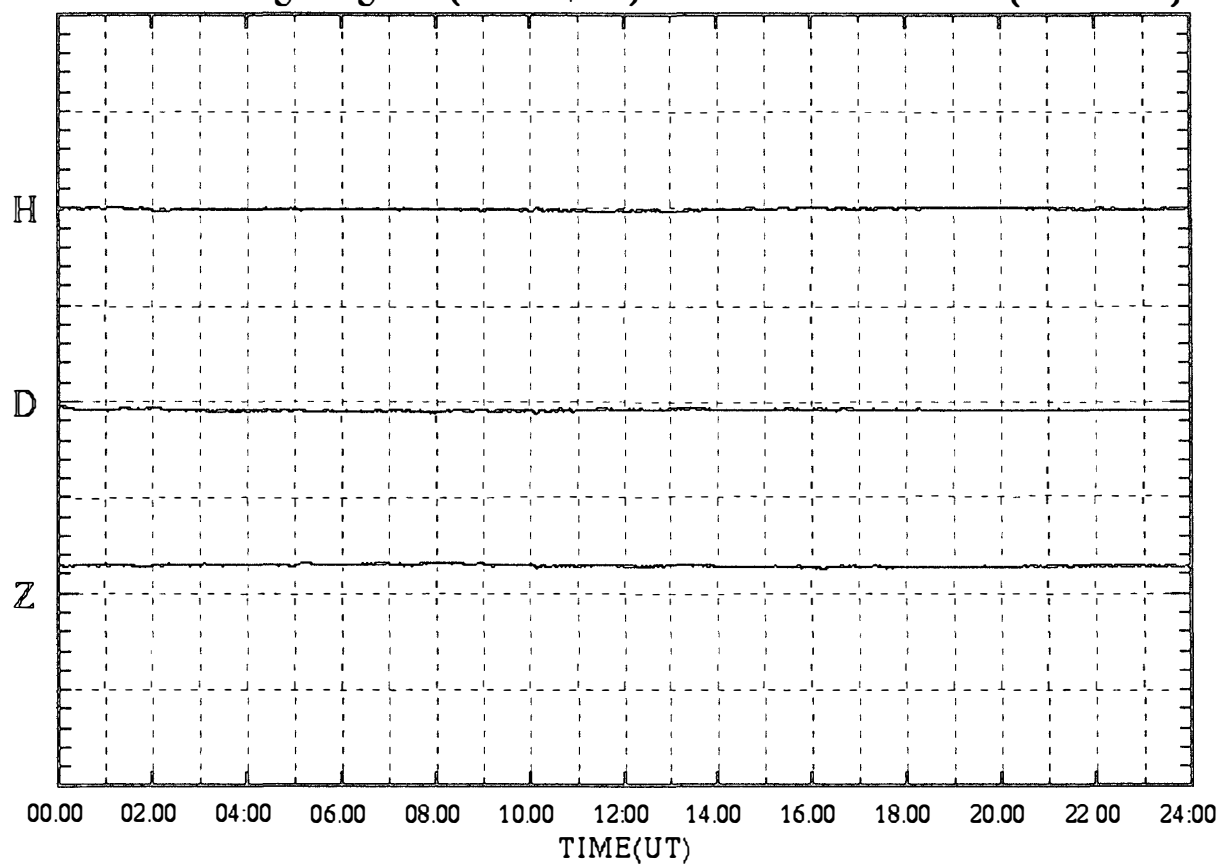

SYOWA magnetogram (100 nT/div)

07 Jun.1999 (DAY:158)

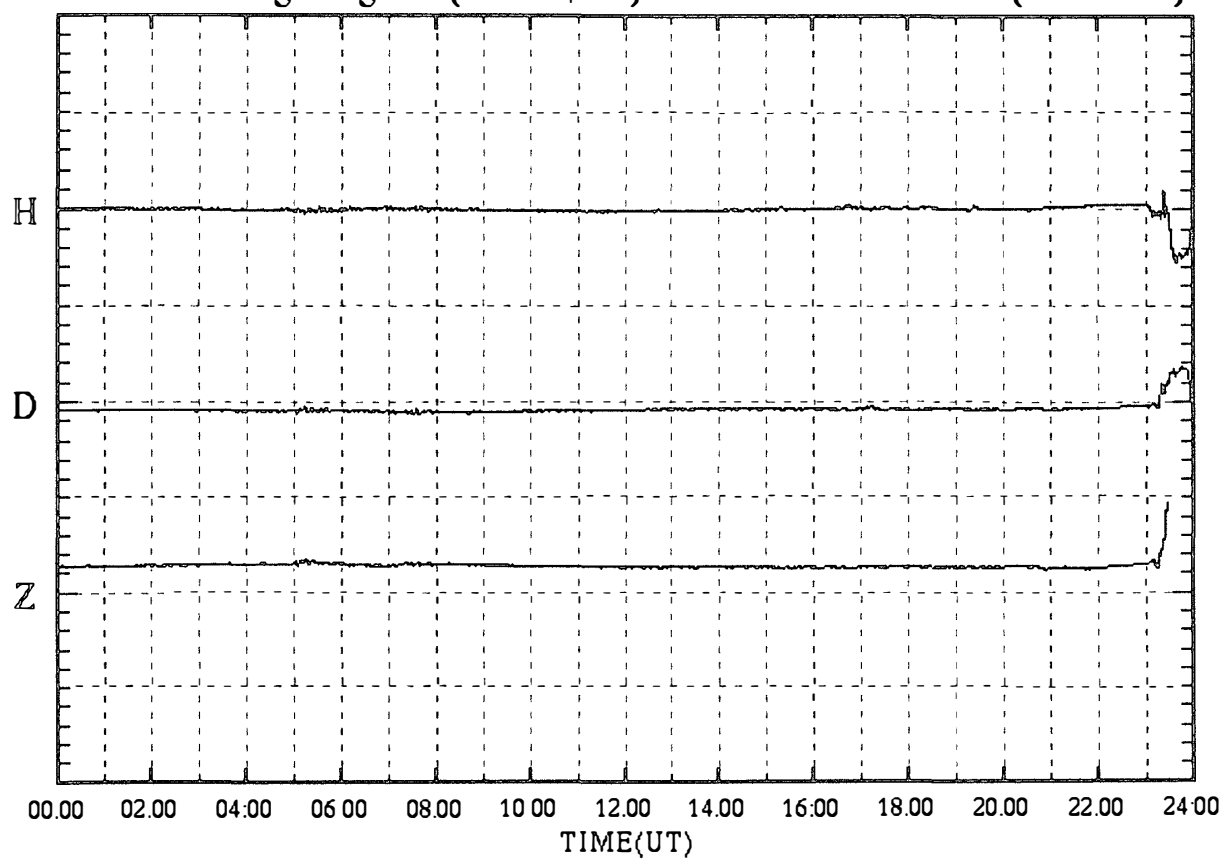

SYOWA magnetogram (100 nT/div)

08 Jun.1999 (DAY:159)

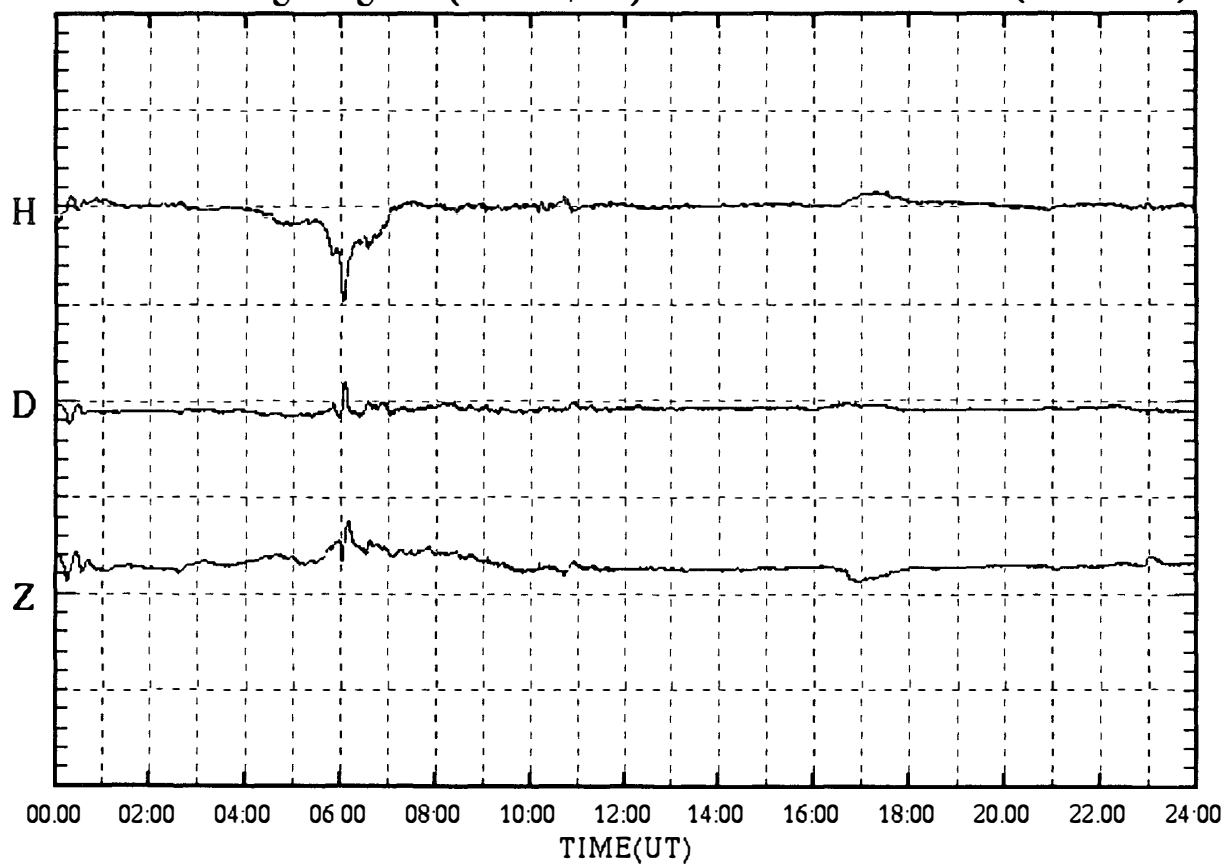

SYOWA magnetogram (100 nT/div)

09 Jun.1999 (DAY:160)

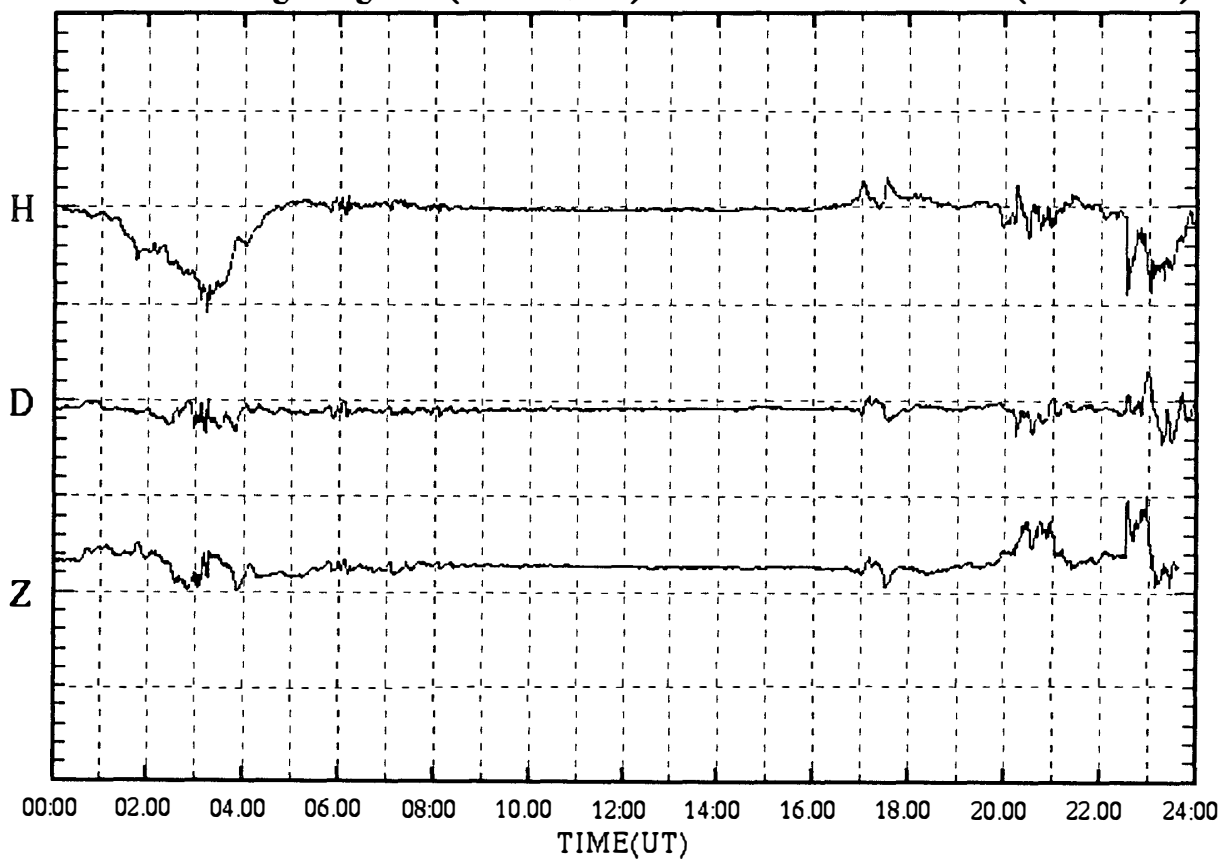



SYOWA magnetogram (100 nT/div)

10 Jun.1999 (DAY:161)

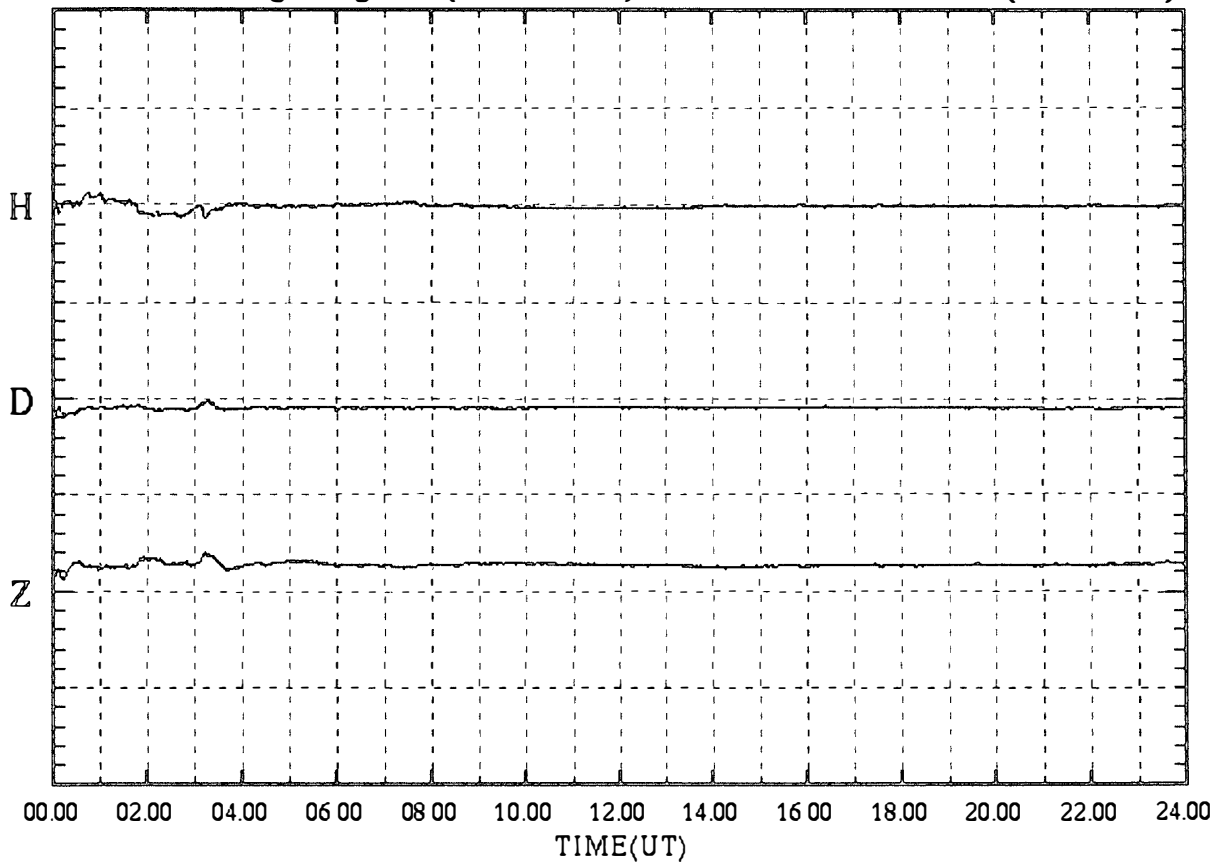

SYOWA magnetogram (100 nT/div)

11 Jun.1999 (DAY:162)

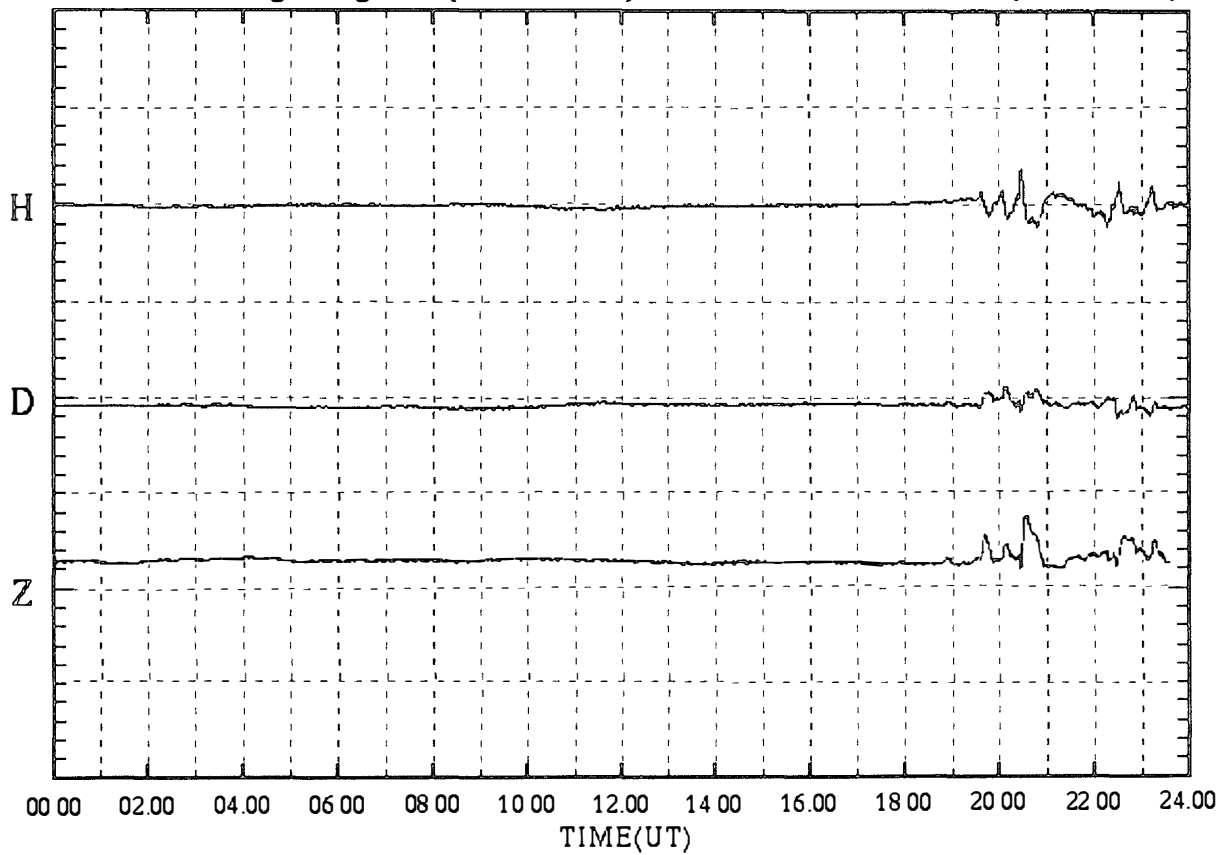

SYOWA magnetogram (100 nT/div)

12 Jun.1999 (DAY:163)

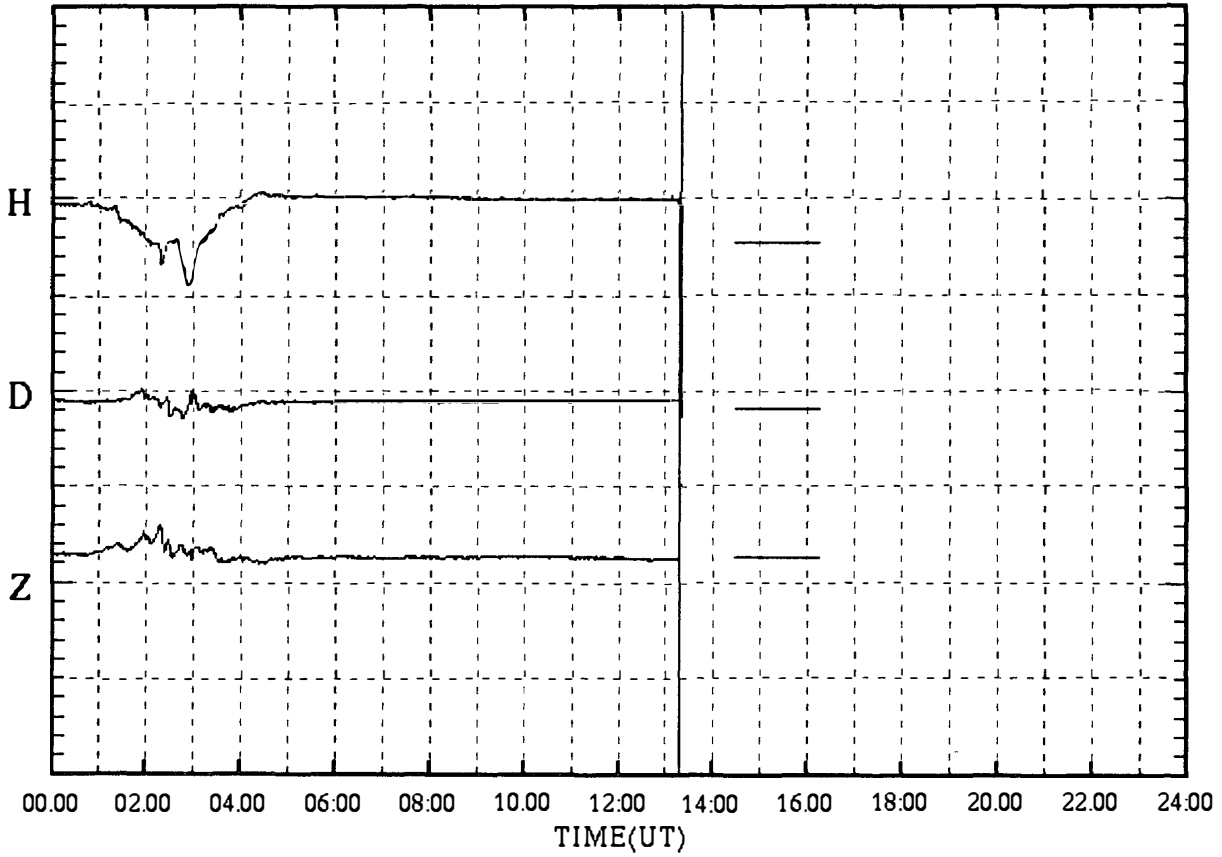

SYOWA magnetogram (100 nT/div)

13 Jun.1999 (DAY:164)

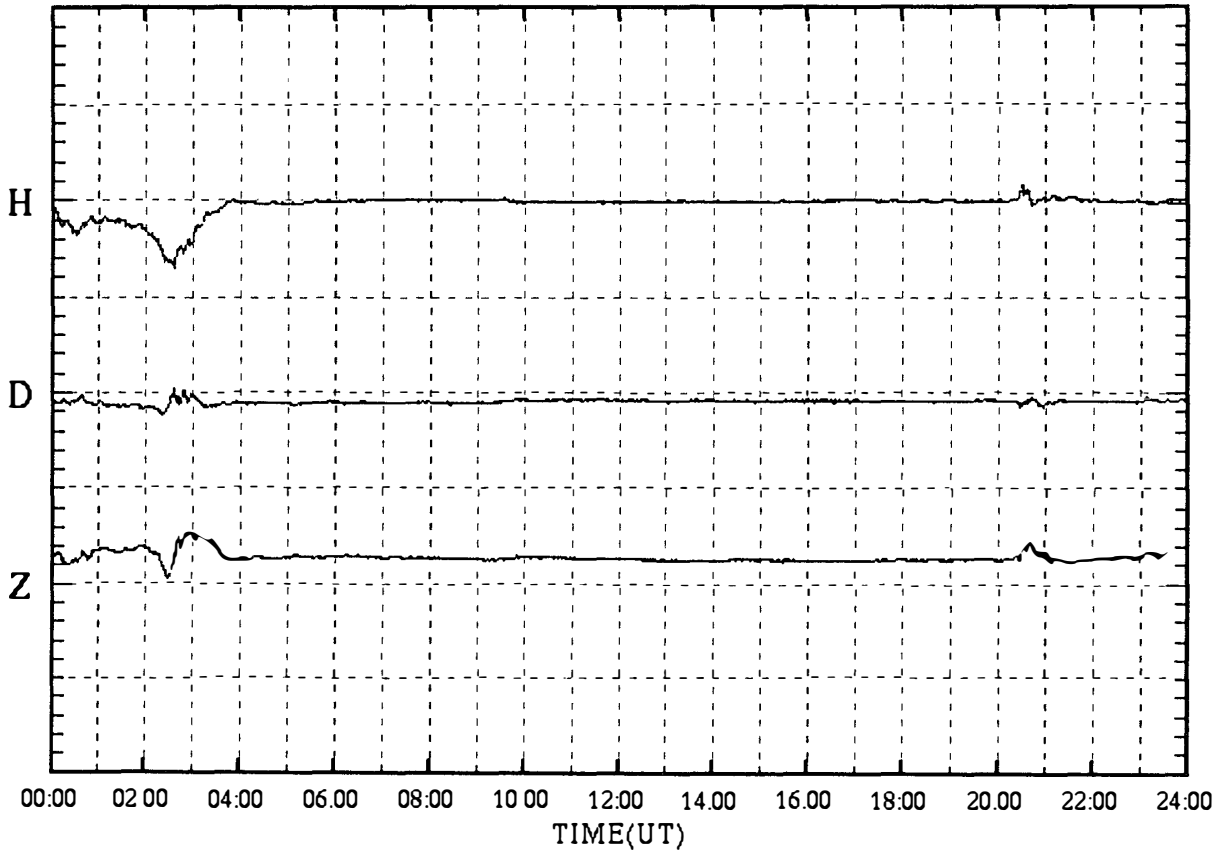

SYOWA magnetogram (100 nT/div)

14 Jun.1999 (DAY:165)

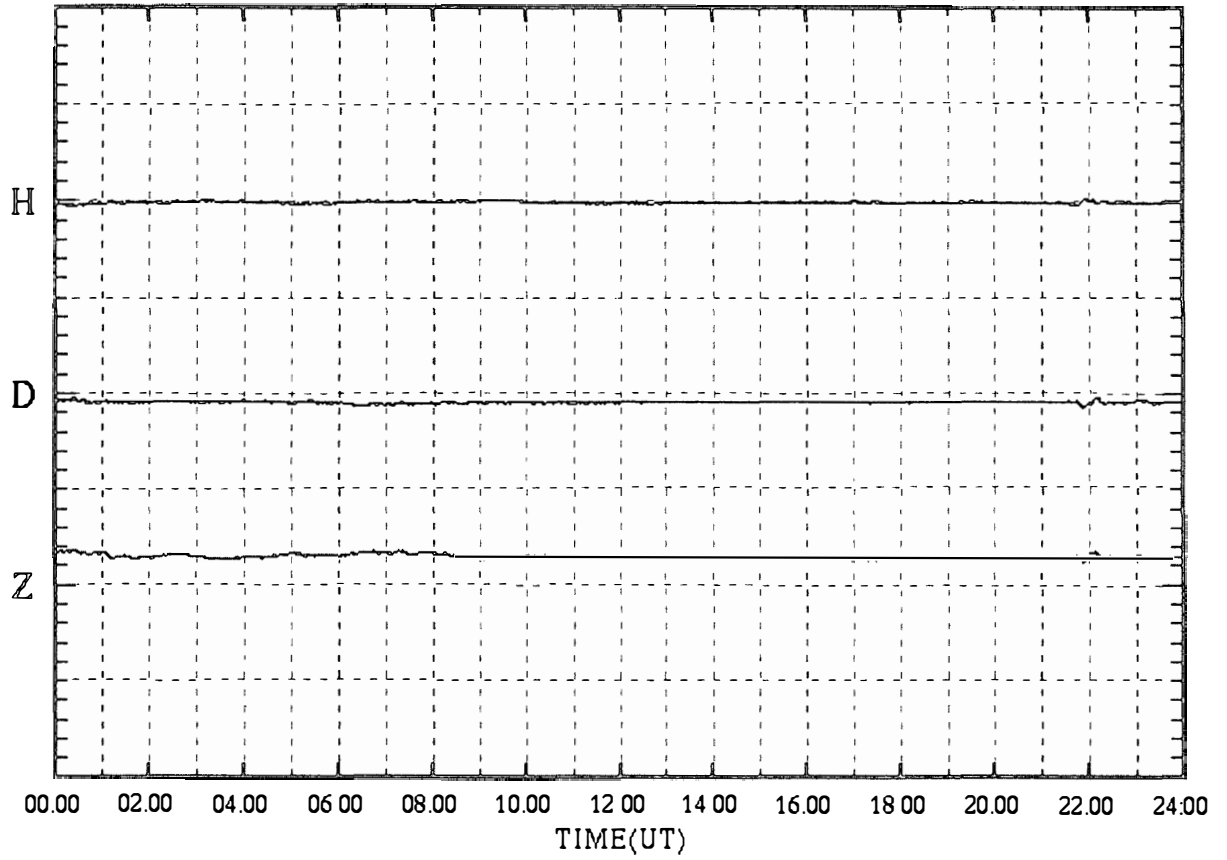

SYOWA magnetogram (100 nT/div)

15 Jun.1999 (DAY:166)

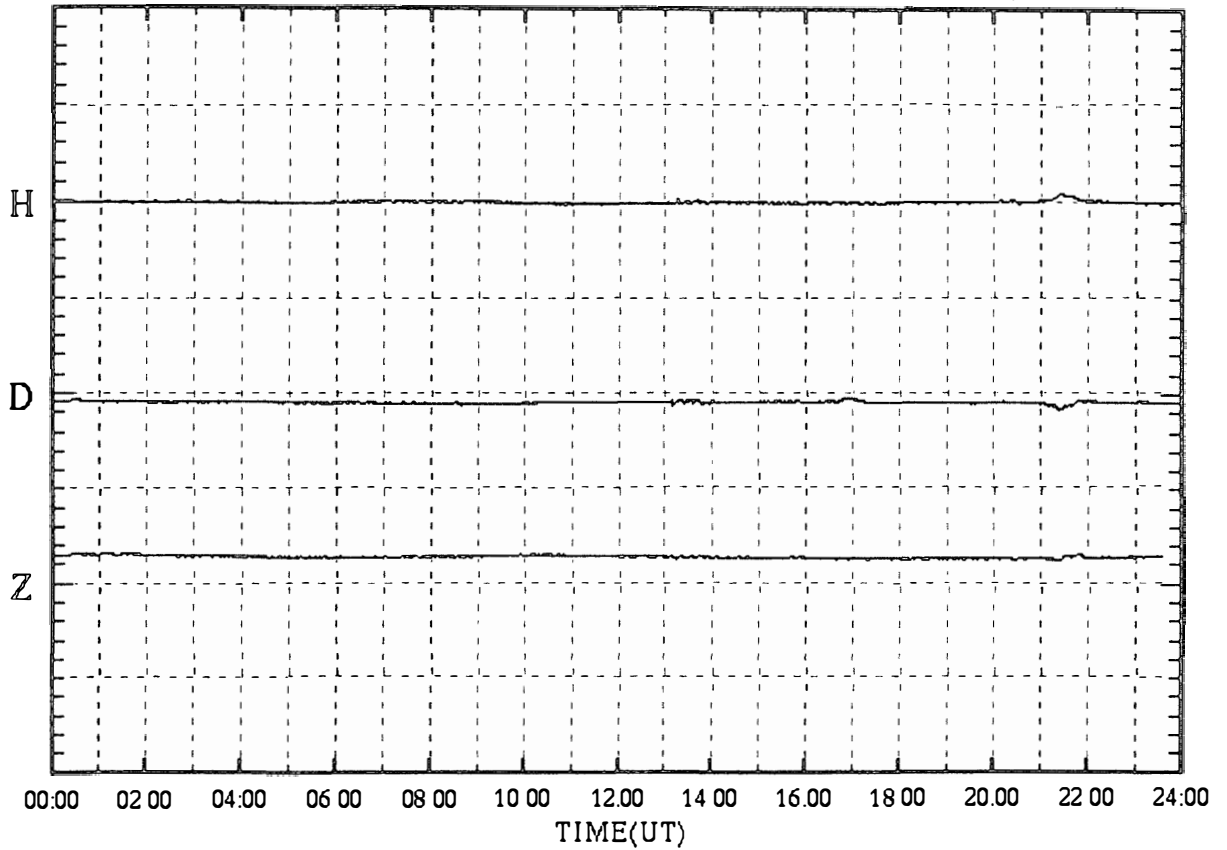

SYOWA magnetogram (100 nT/div)

16 Jun.1999 (DAY:167)

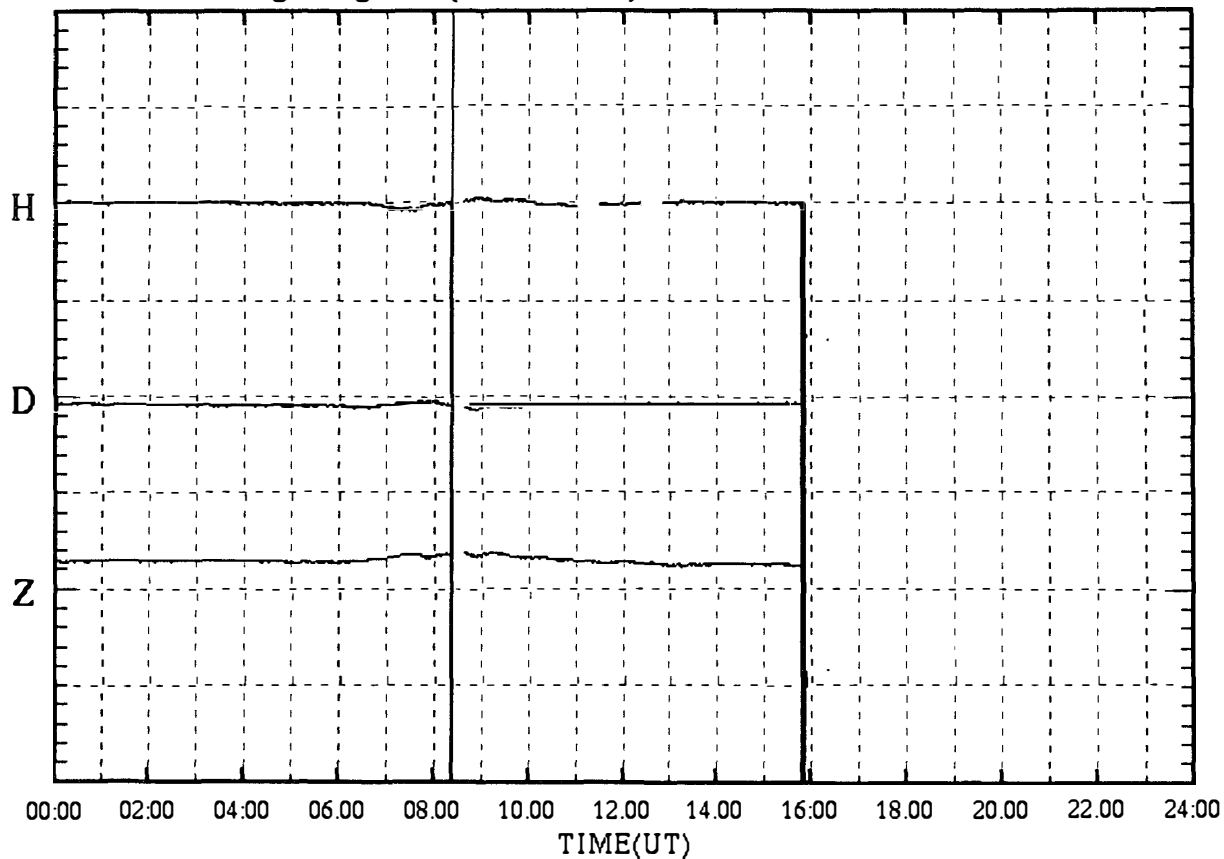

SYOWA magnetogram (100 nT/div)

17 Jun.1999 (DAY:168)

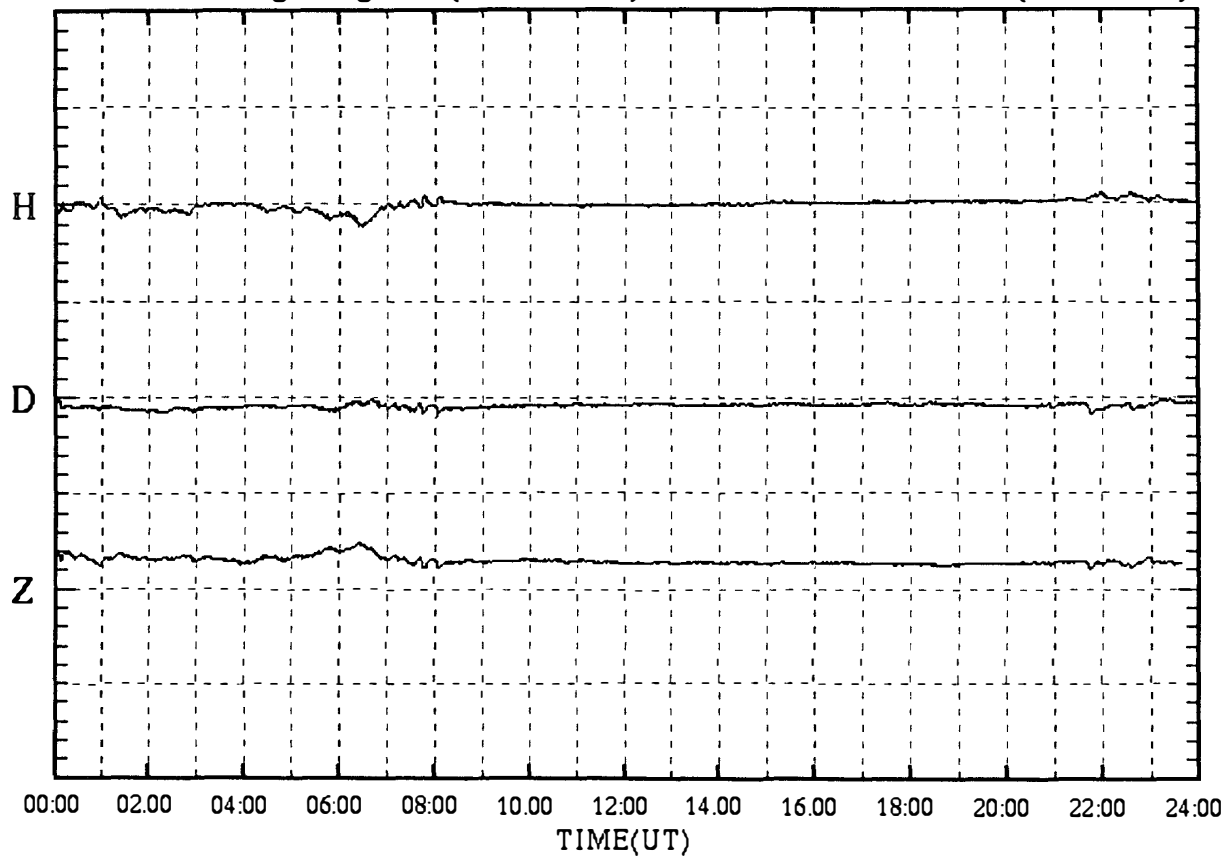

SYOWA magnetogram (100 nT/div)

18 Jun.1999 (DAY:169)

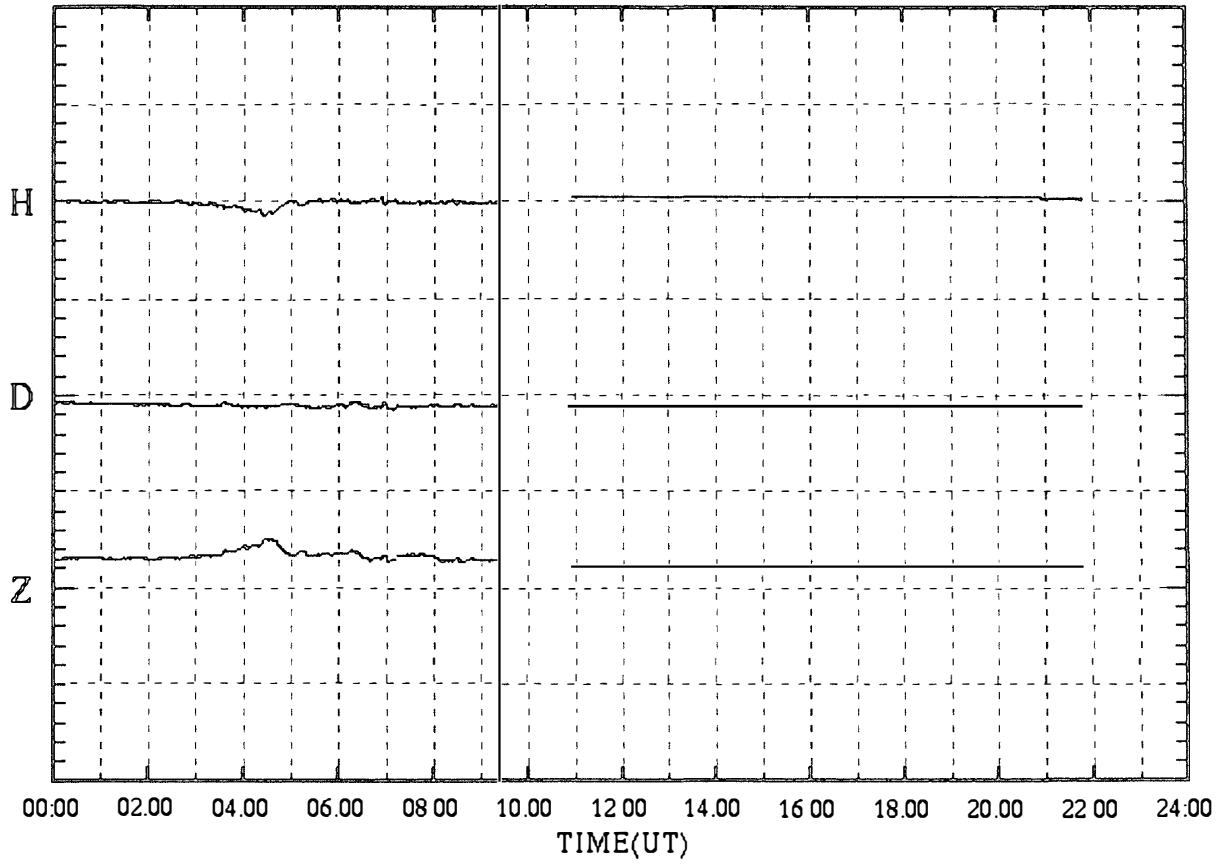

SYOWA magnetogram (100 nT/div)

19 Jun.1999 (DAY:170)

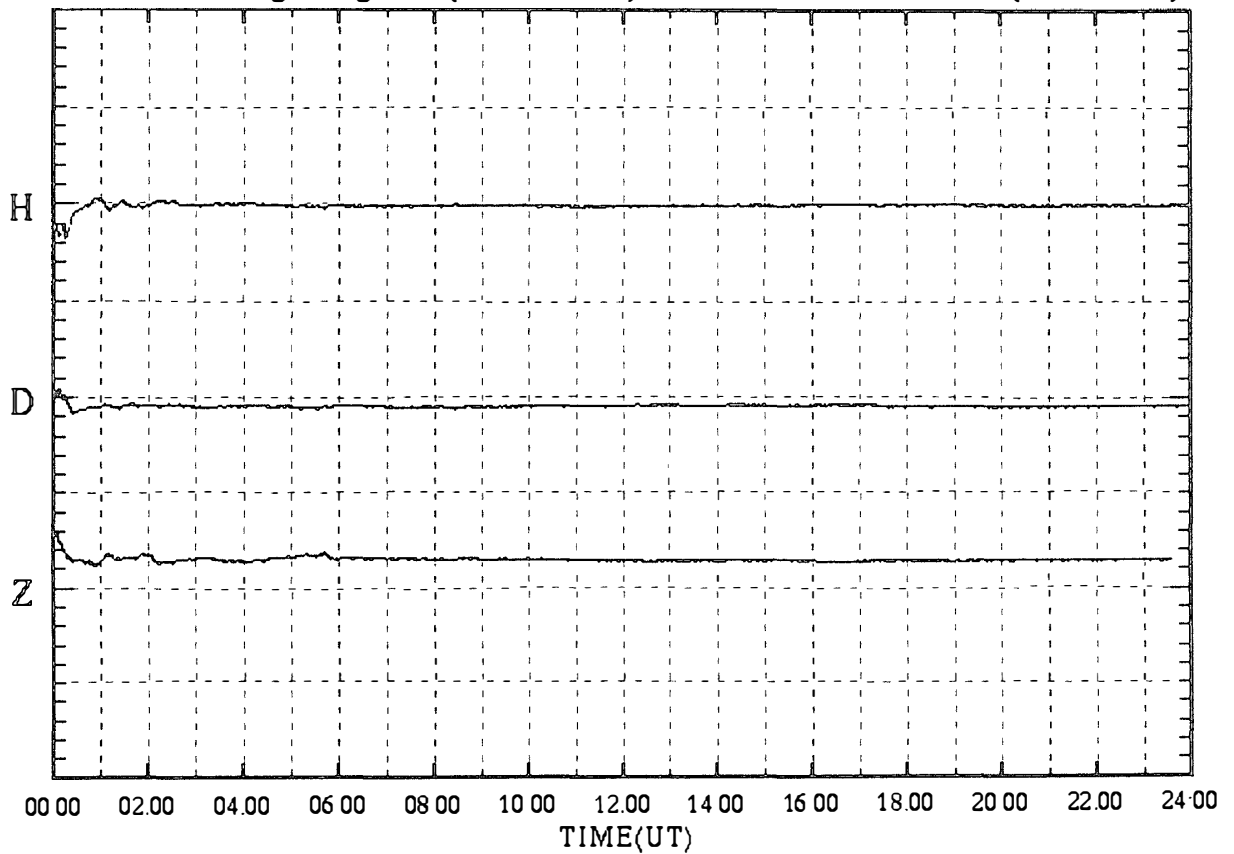

SYOWA magnetogram (100 nT/div)

20 Jun.1999 (DAY:171)

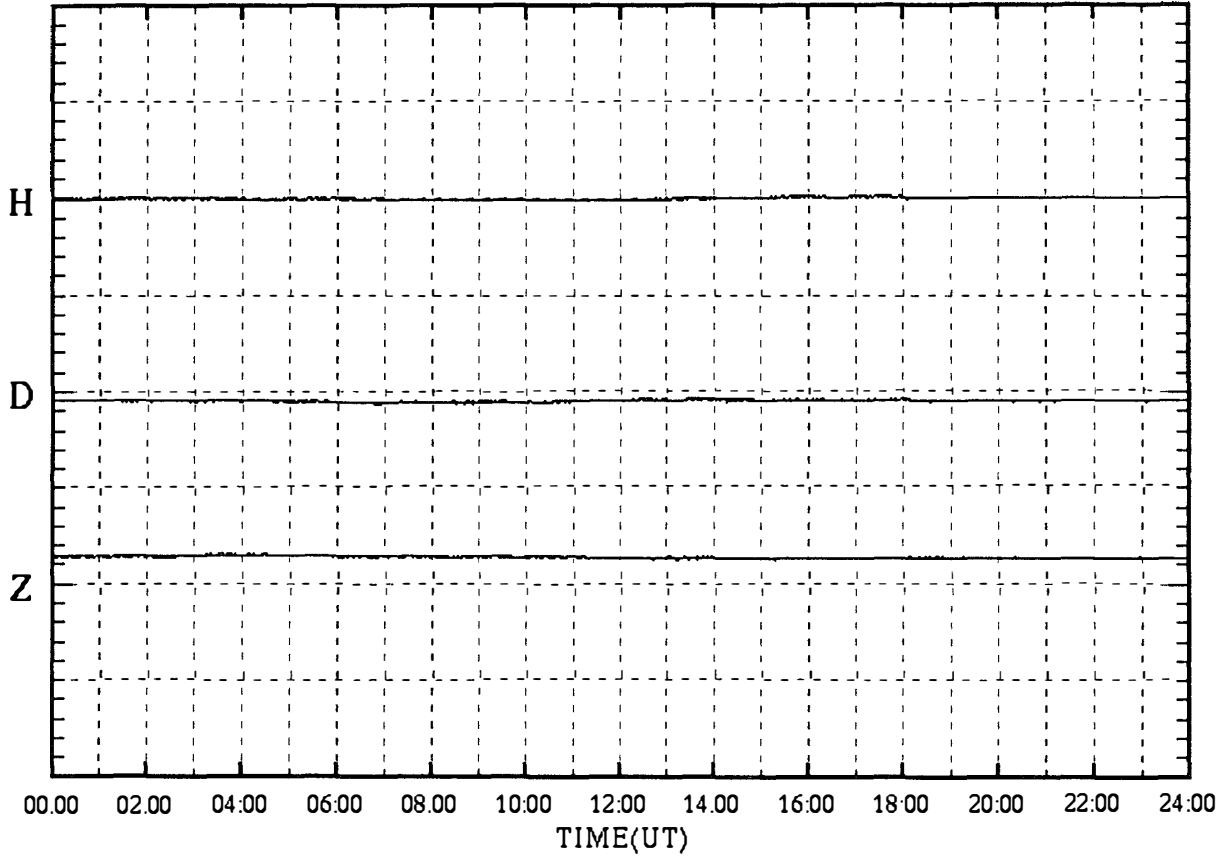

SYOWA magnetogram (100 nT/div)

21 Jun.1999 (DAY:172)

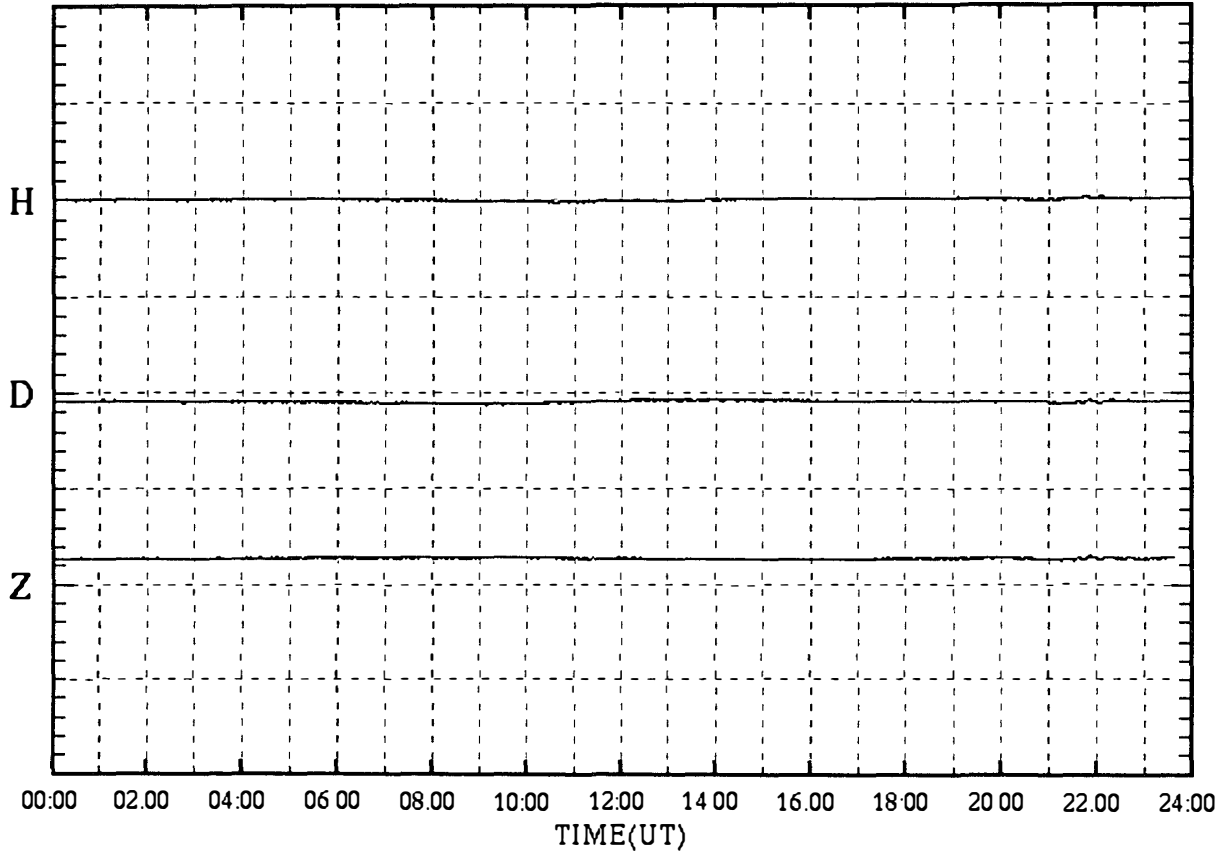

SYOWA magnetogram (100 nT/div)

22 Jun.1999 (DAY:173)

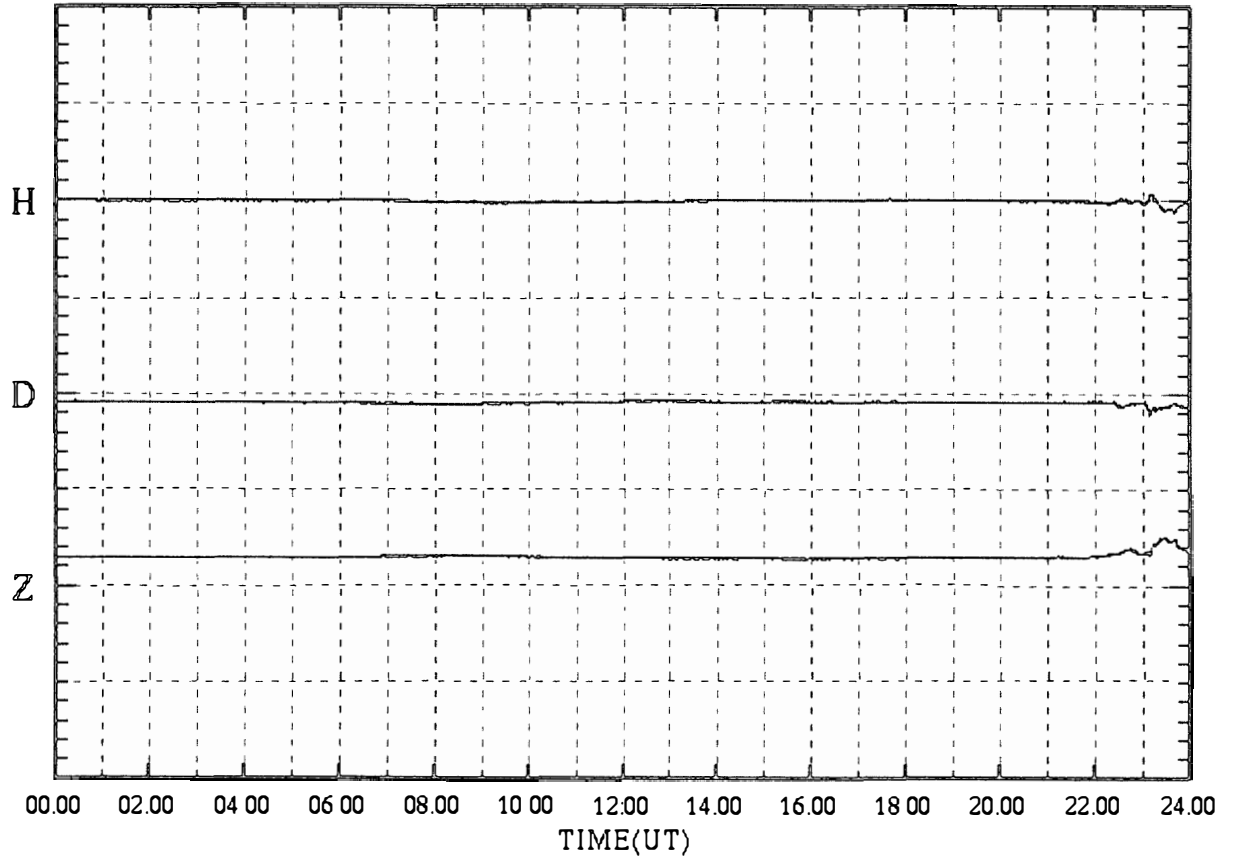

SYOWA magnetogram (100 nT/div)

23 Jun.1999 (DAY:174)

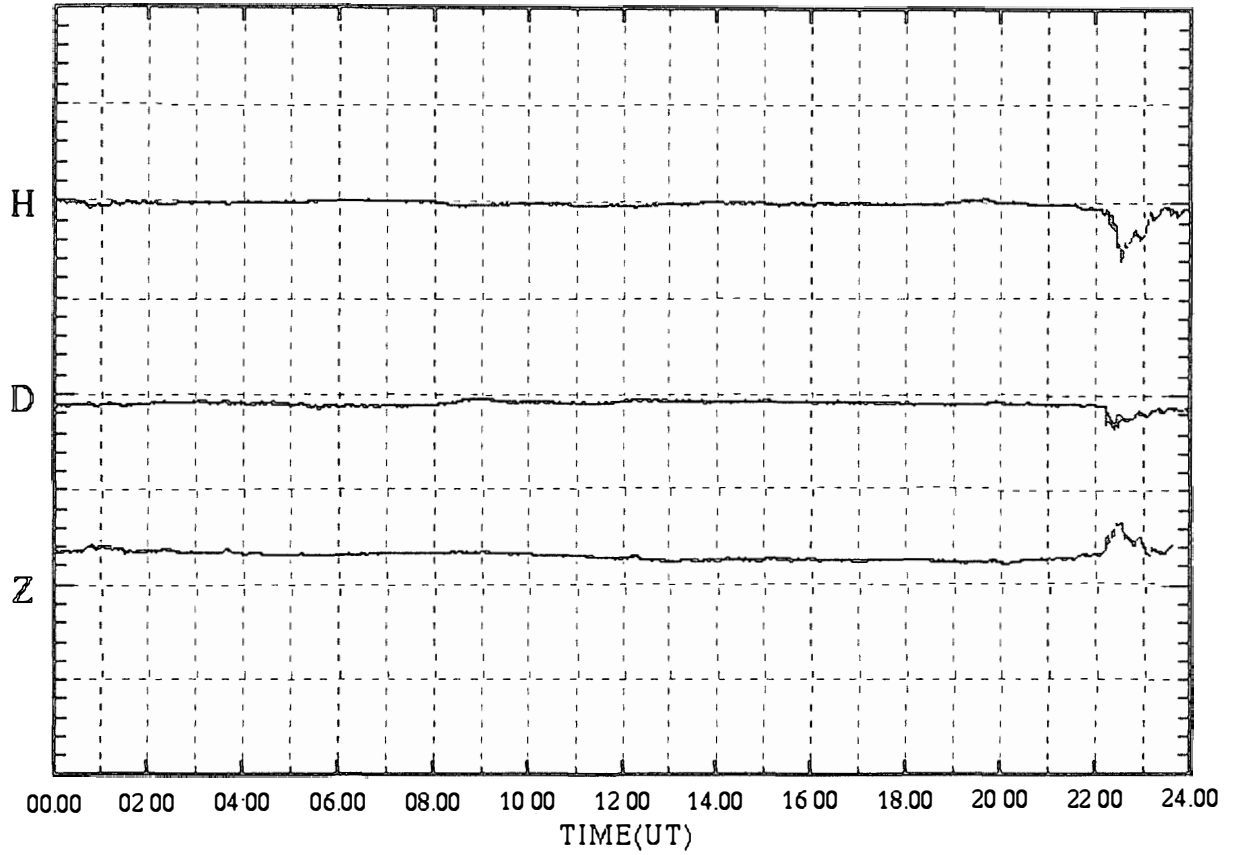

SYOWA magnetogram (100 nT/div)

24 Jun.1999 (DAY:175)

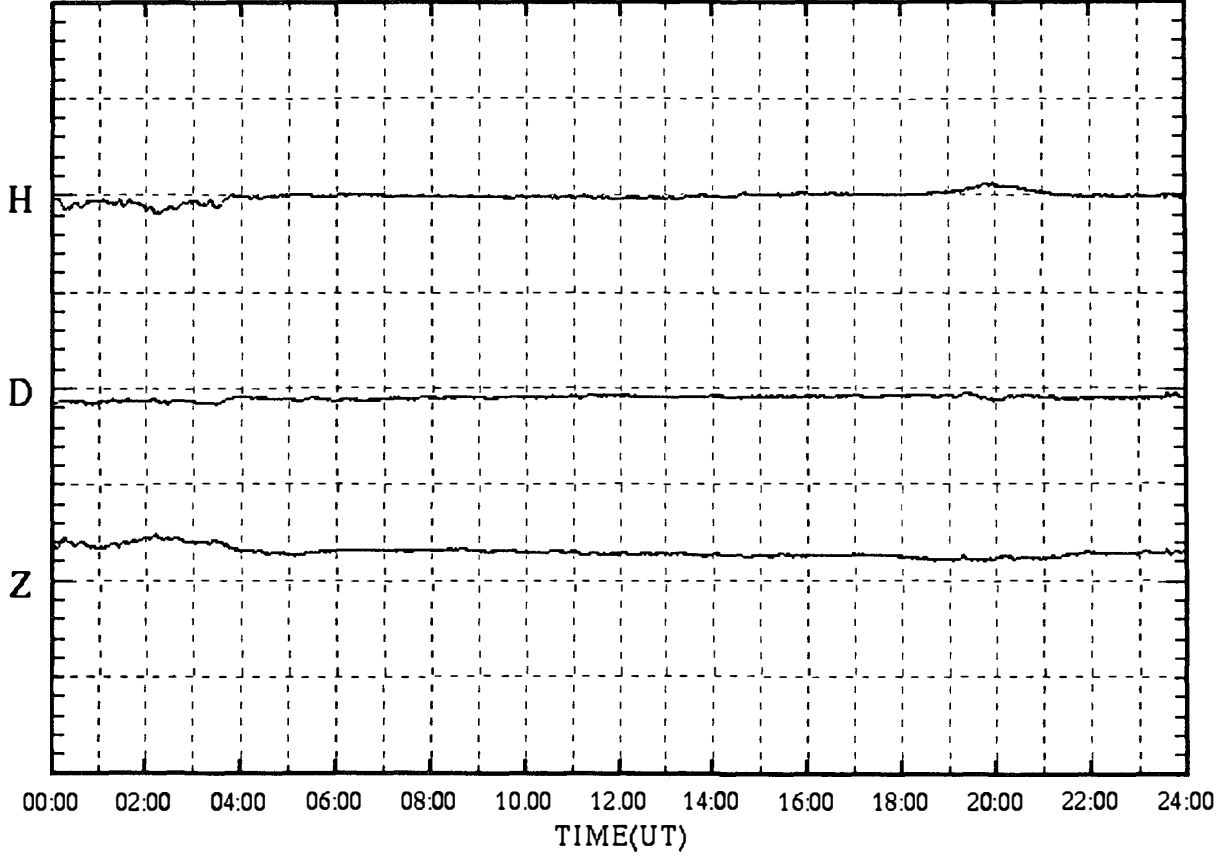

SYOWA magnetogram (100 nT/div)

25 Jun.1999 (DAY:176)

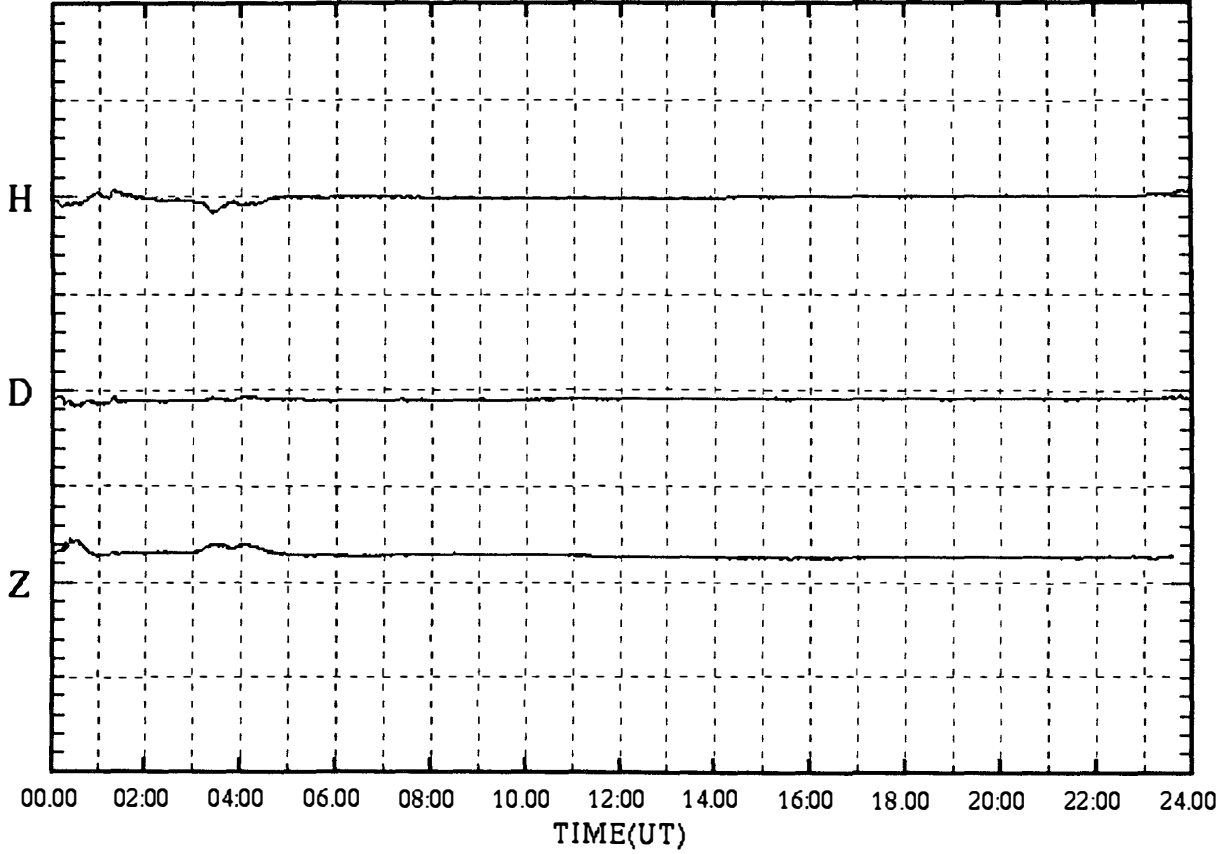



SYOWA magnetogram (100 nT/div)

26 Jun.1999 (DAY:177)

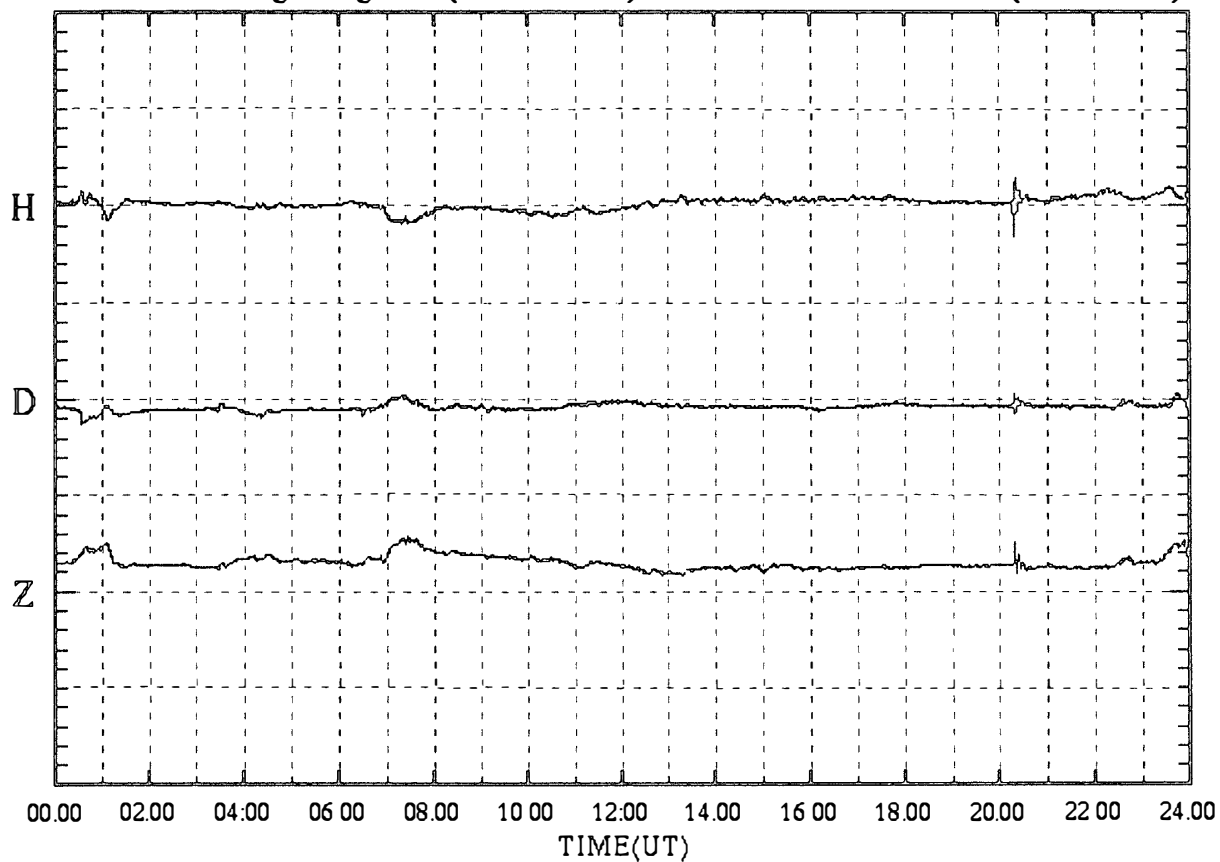

SYOWA magnetogram (100 nT/div)

27 Jun.1999 (DAY:178)

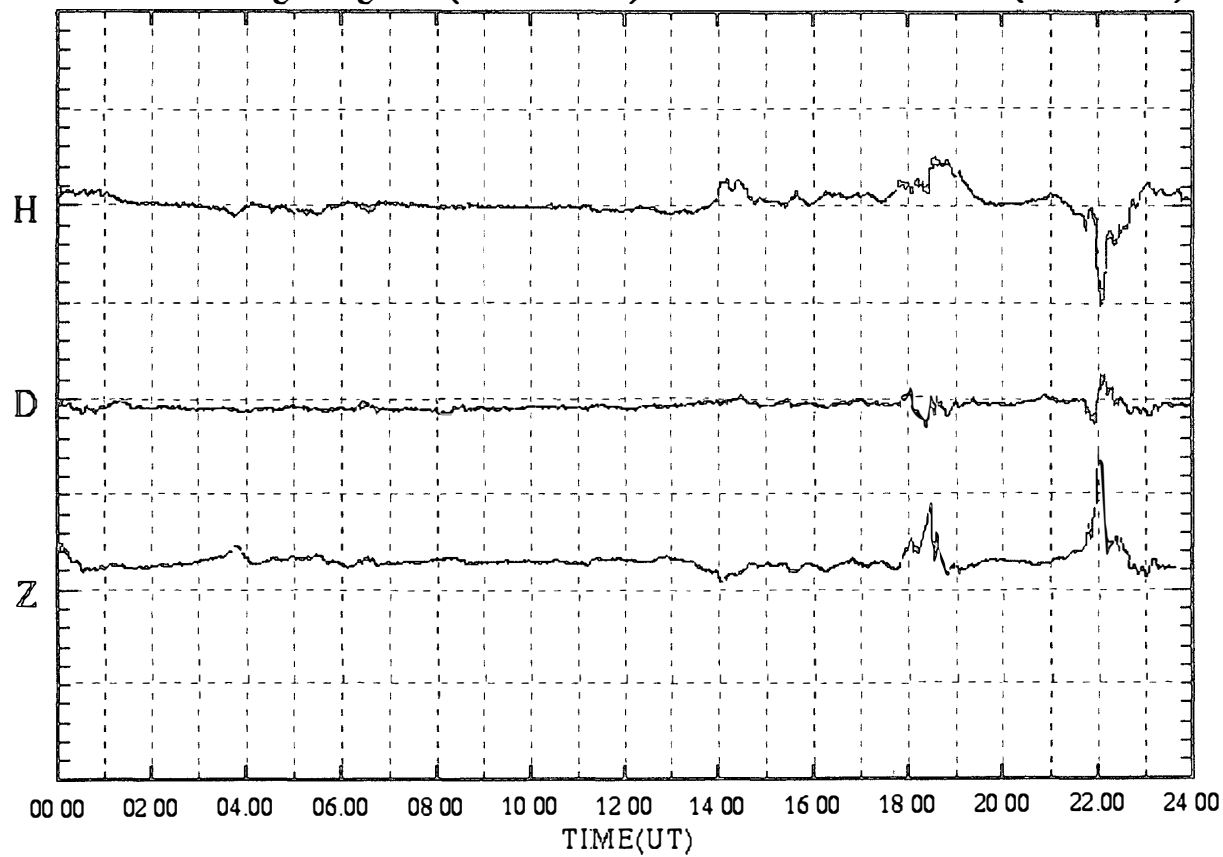

SYOWA magnetogram (100 nT/div)

28 Jun.1999 (DAY:179)

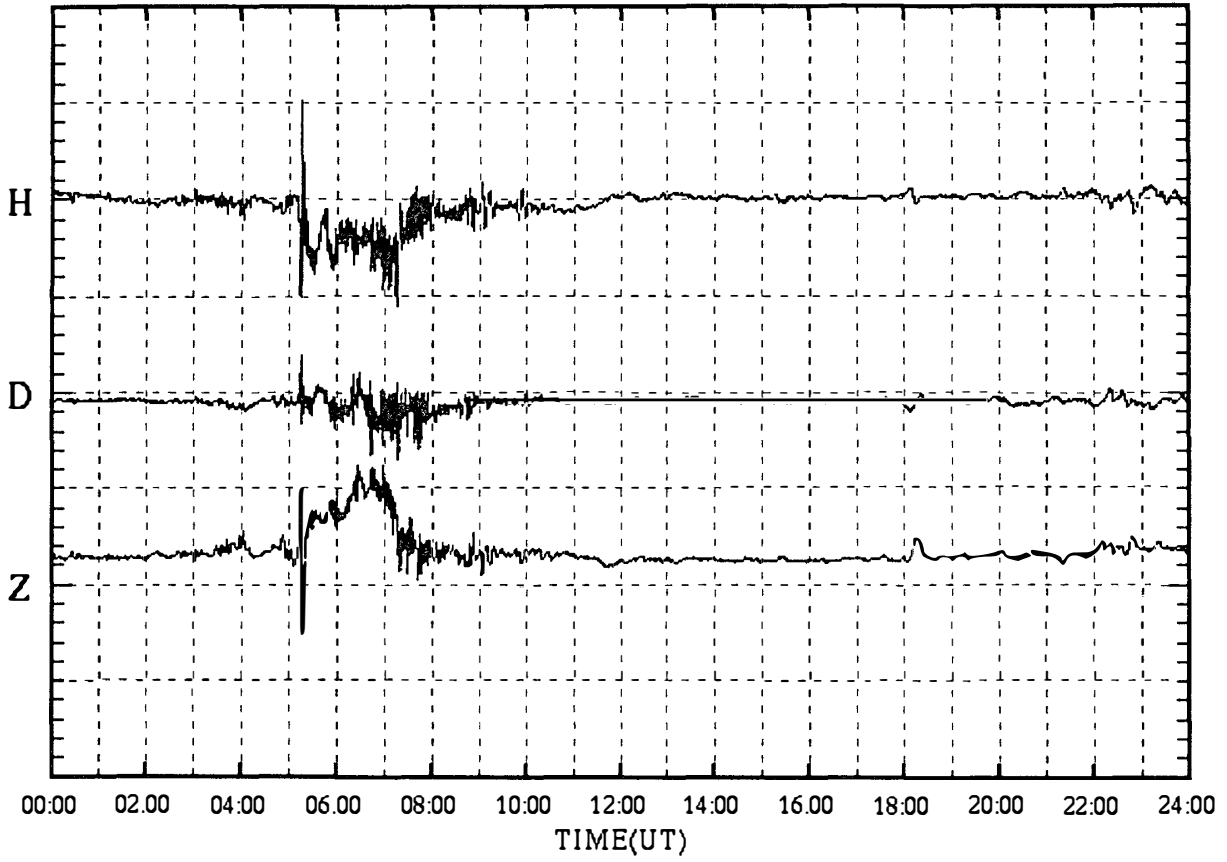

SYOWA magnetogram (100 nT/div)

29 Jun.1999 (DAY:180)

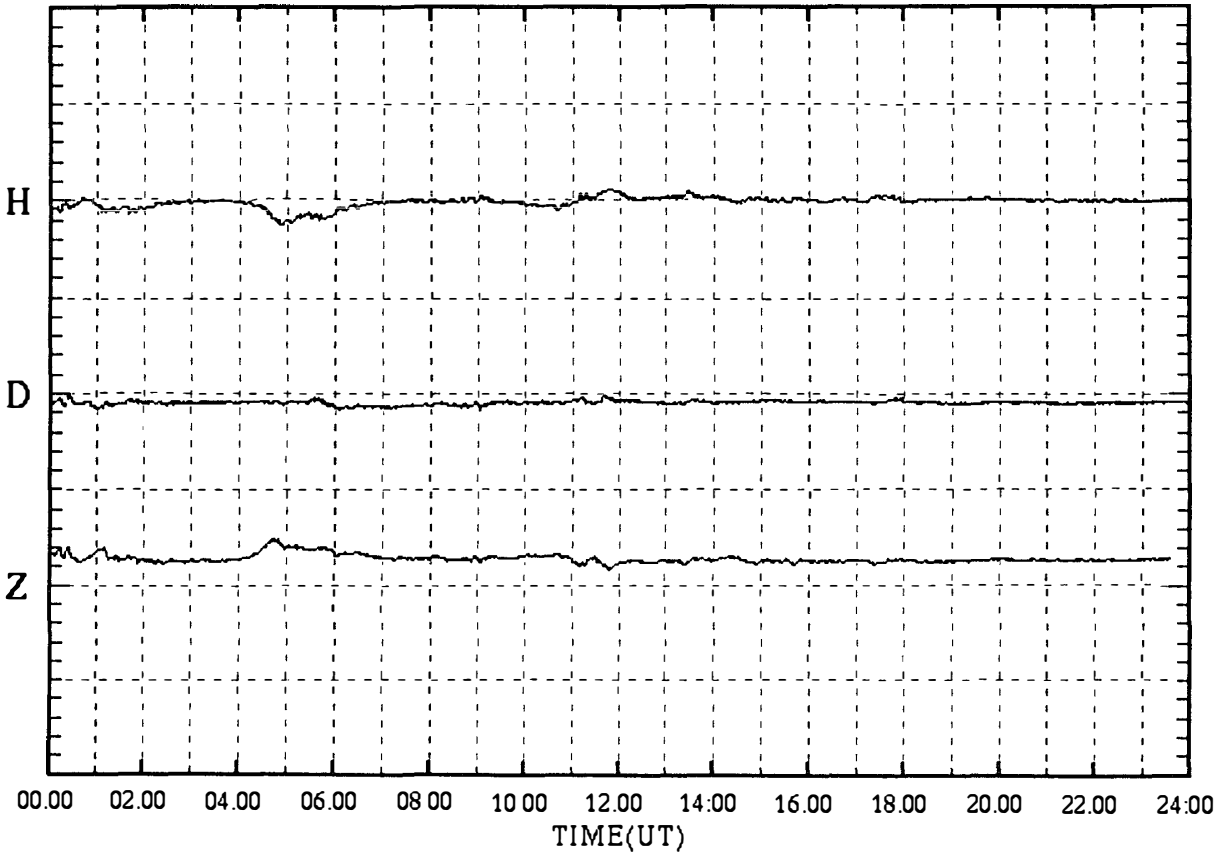

SYOWA magnetogram (100 nT/div)

30 Jun.1999 (DAY:181)

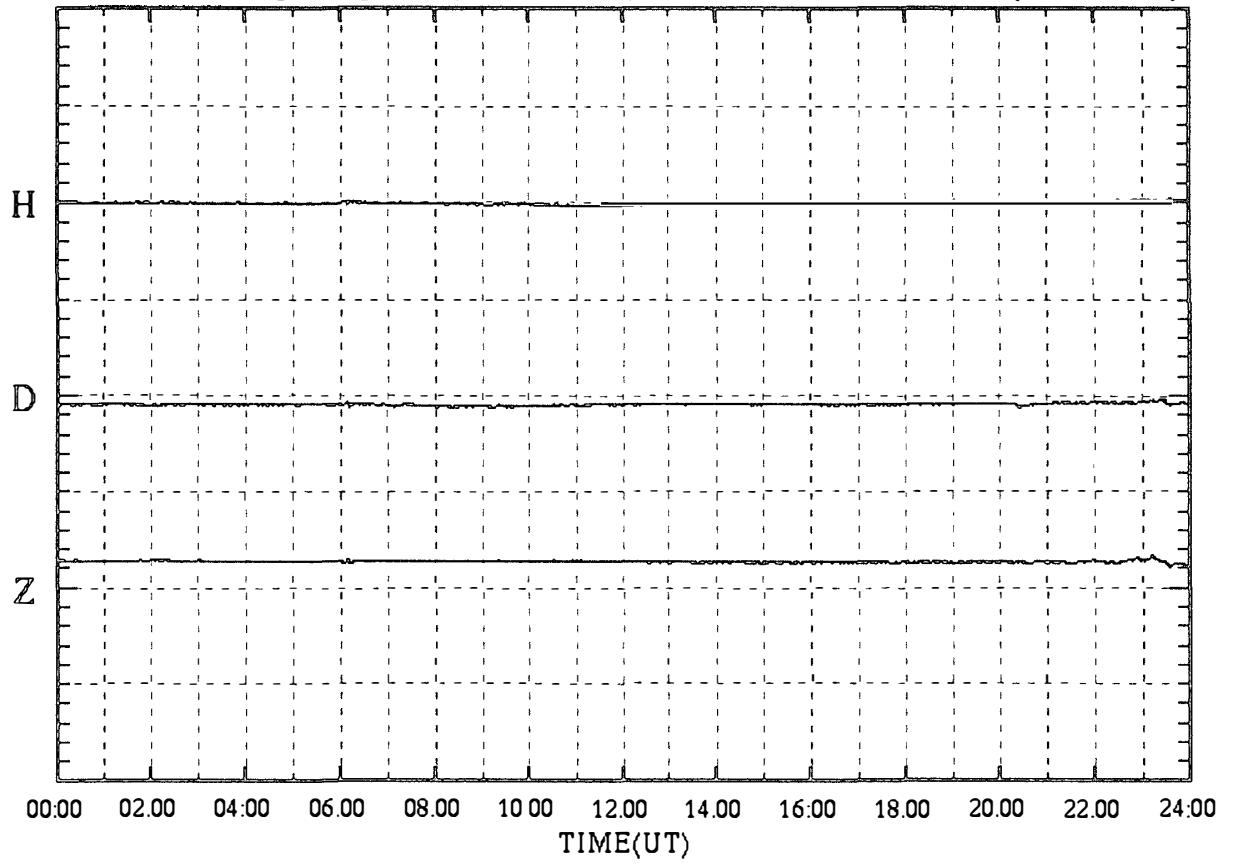

SYOWA magnetogram (100 nT/div)

01 Jul.1999 (DAY:182)

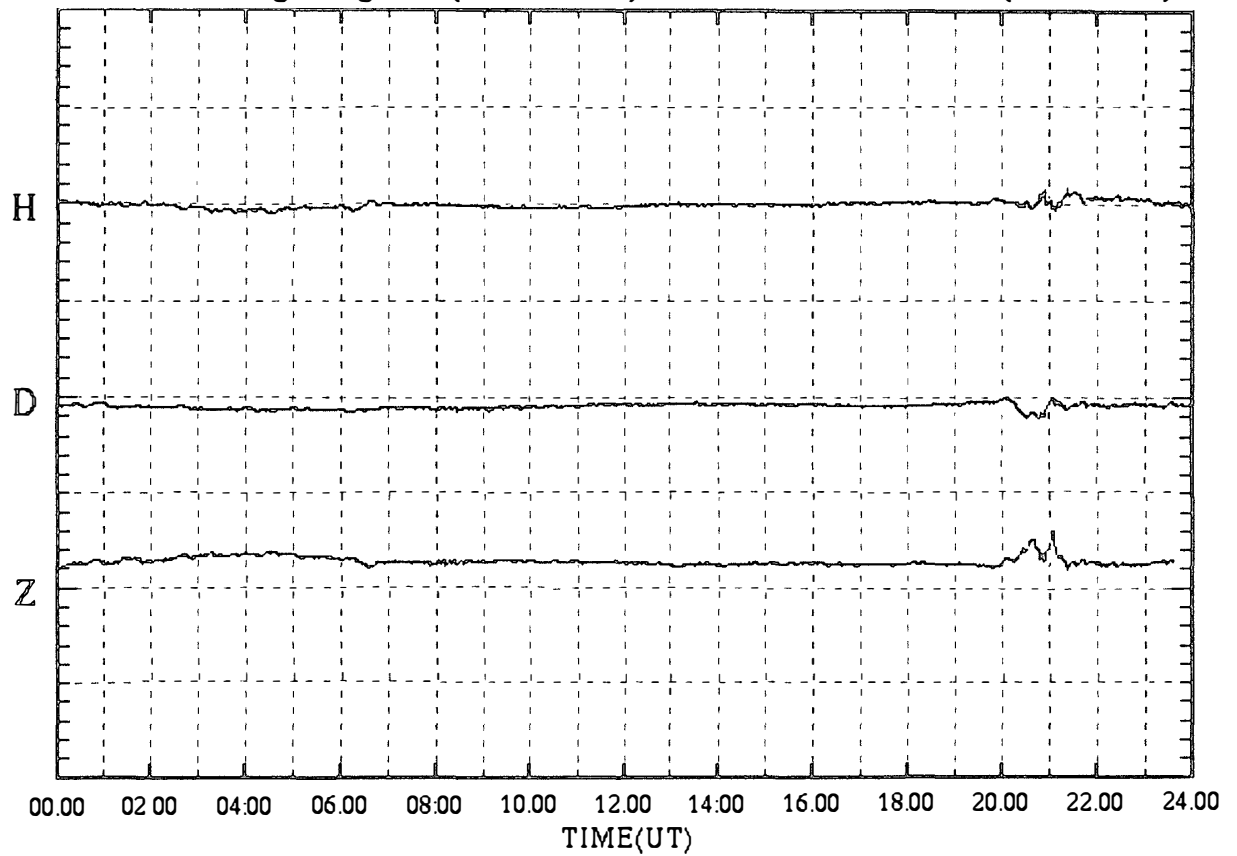

SYOWA magnetogram (100 nT/div)

02 Jul.1999 (DAY:183)

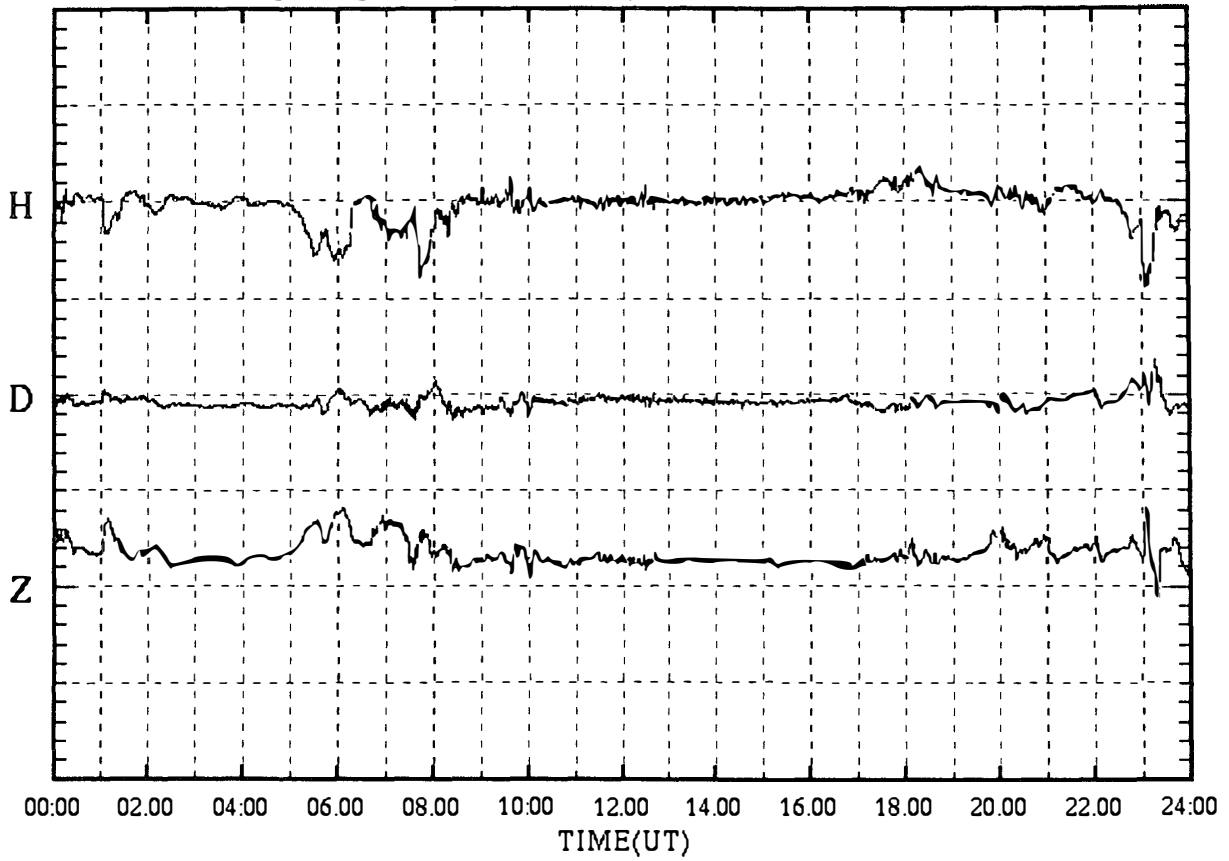

SYOWA magnetogram (100 nT/div)

03 Jul.1999 (DAY:184)

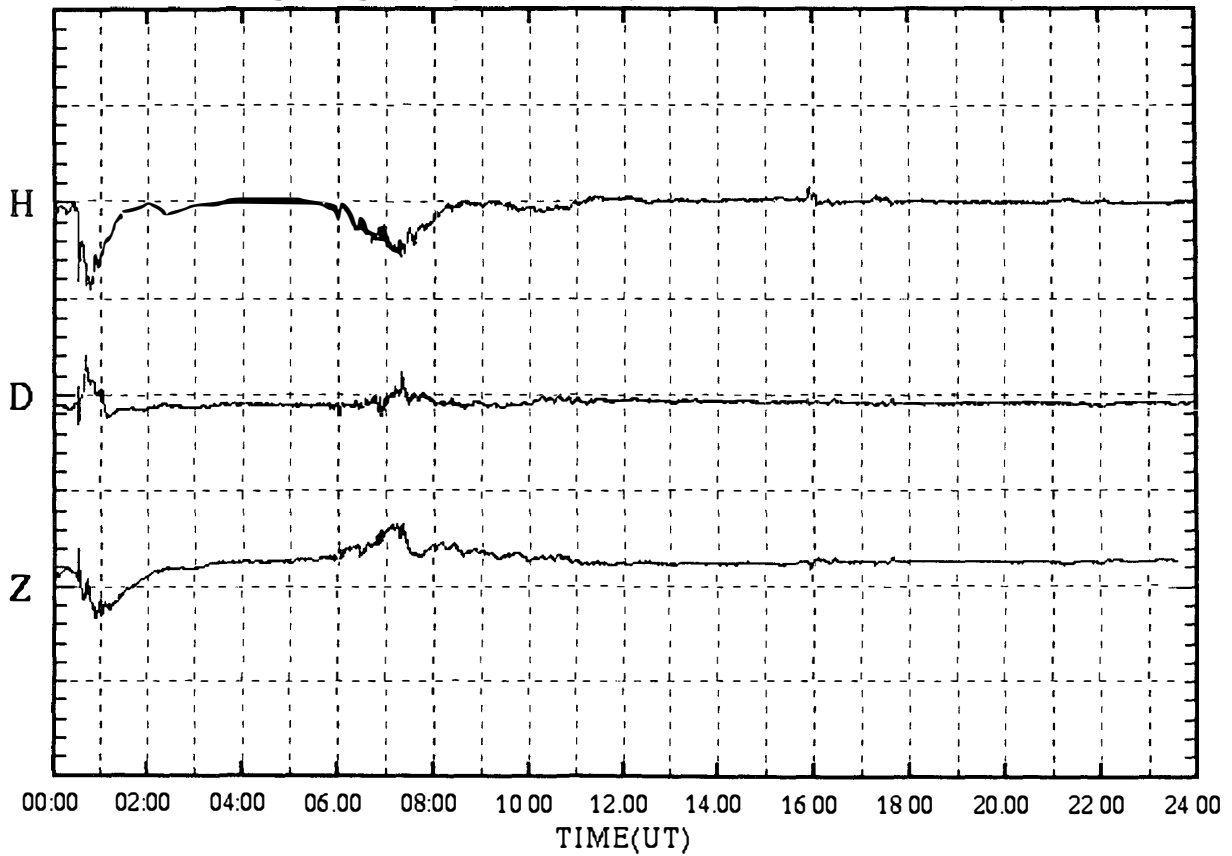

SYOWA magnetogram (100 nT/div)

04 Jul.1999 (DAY:185)

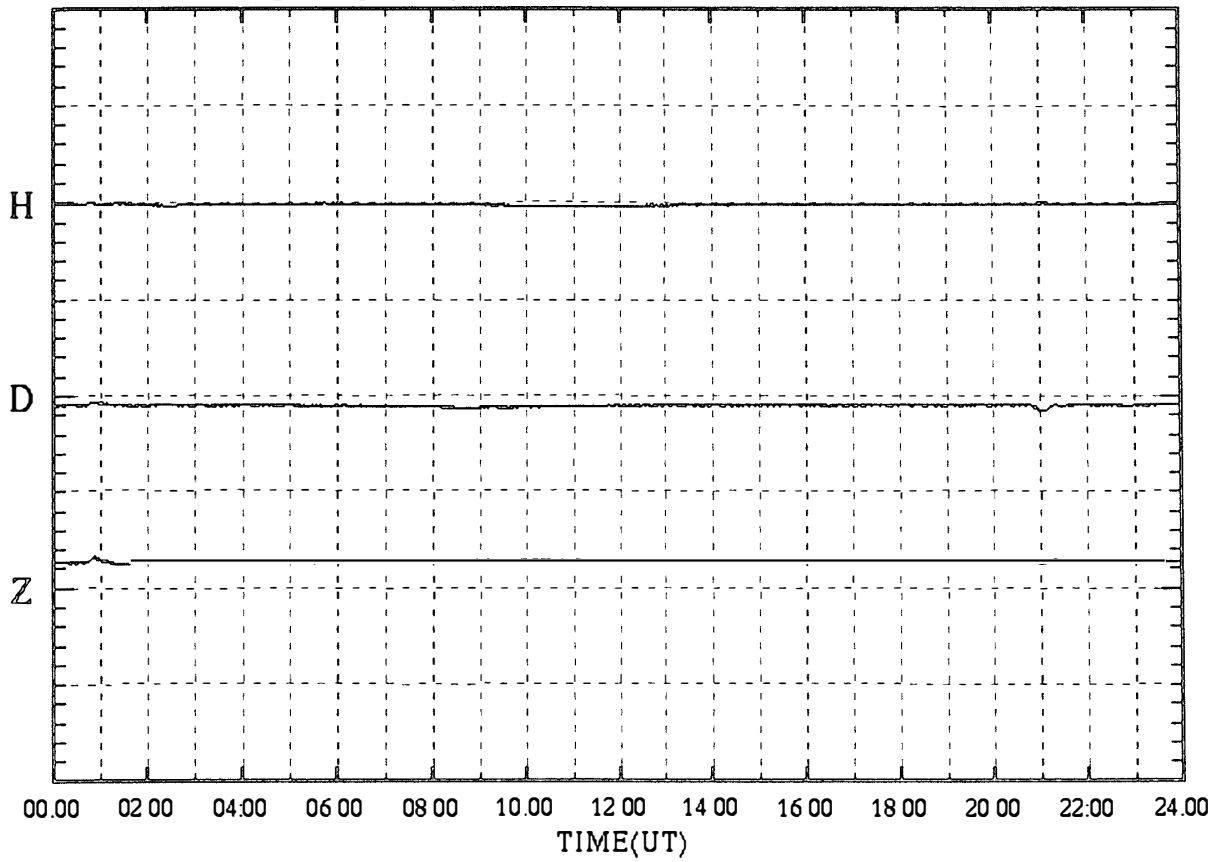

SYOWA magnetogram (100 nT/div)

05 Jul.1999 (DAY:186)

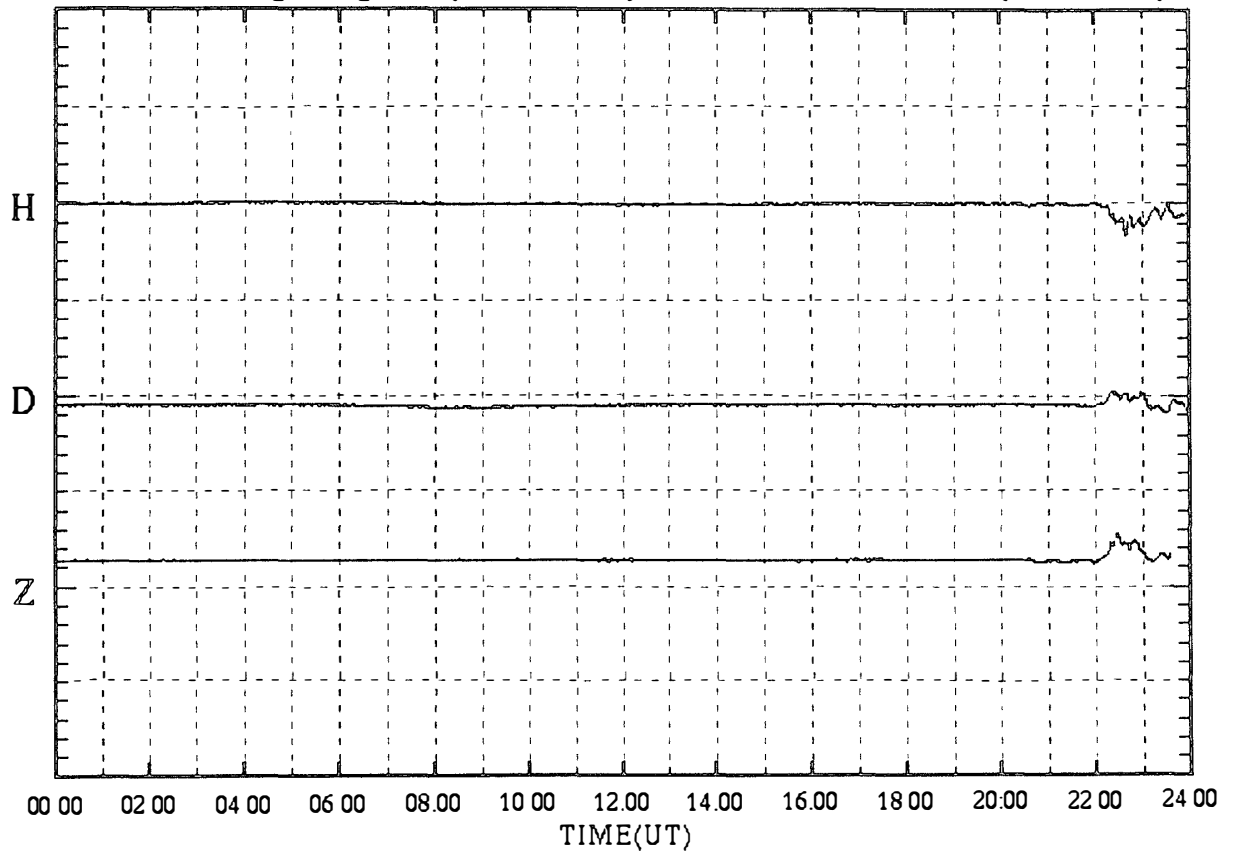

SYOWA magnetogram (100 nT/div)

06 Jul.1999 (DAY:187)

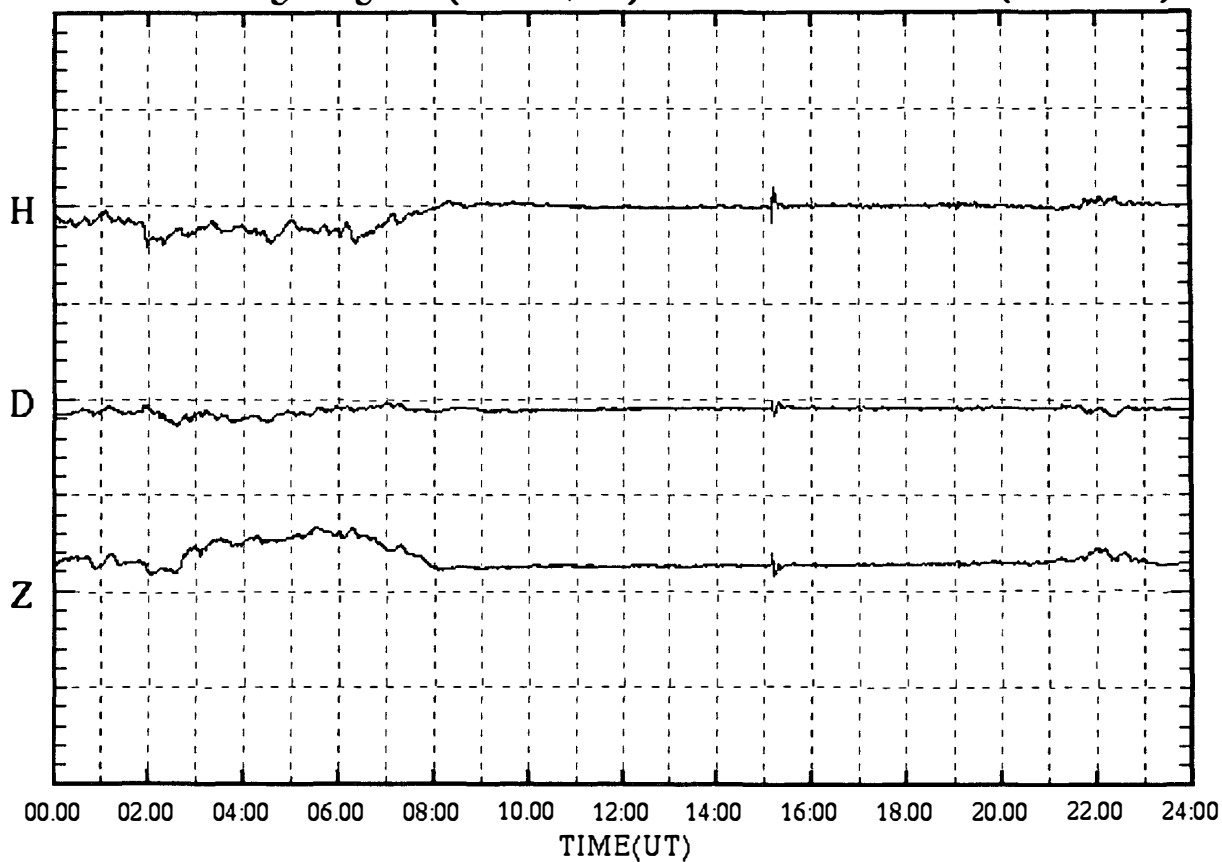

SYOWA magnetogram (100 nT/div)

07 Jul.1999 (DAY:188)

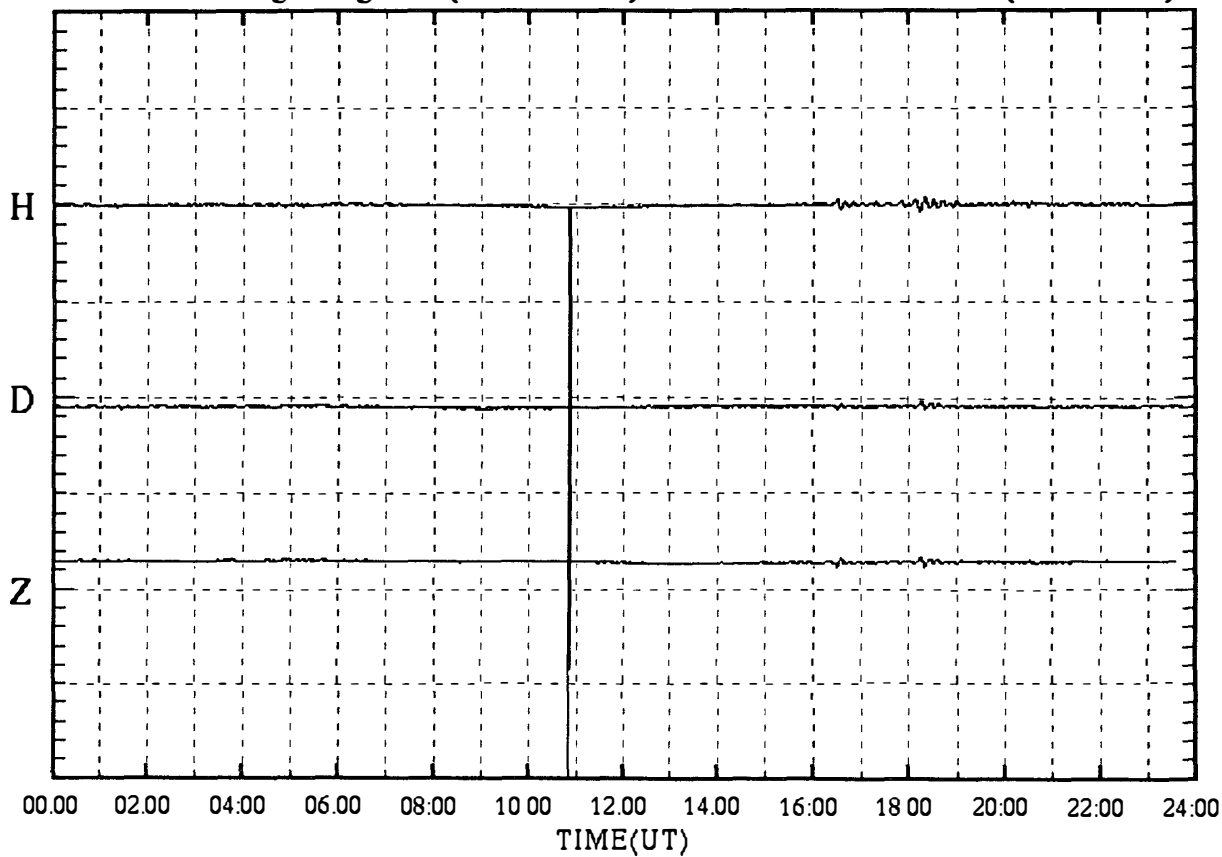

SYOWA magnetogram (100 nT/div)

08 Jul.1999 (DAY:189)

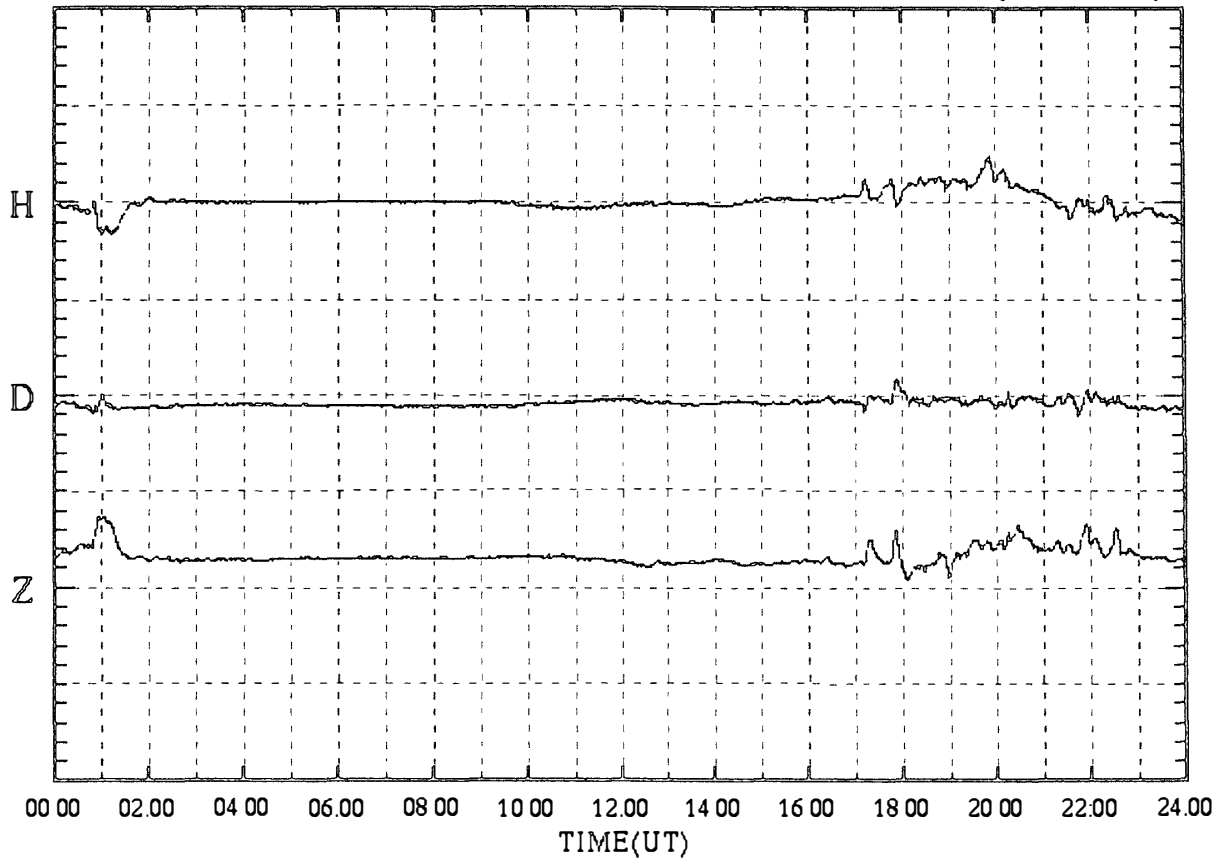

SYOWA magnetogram (100 nT/div)

09 Jul.1999 (DAY:190)

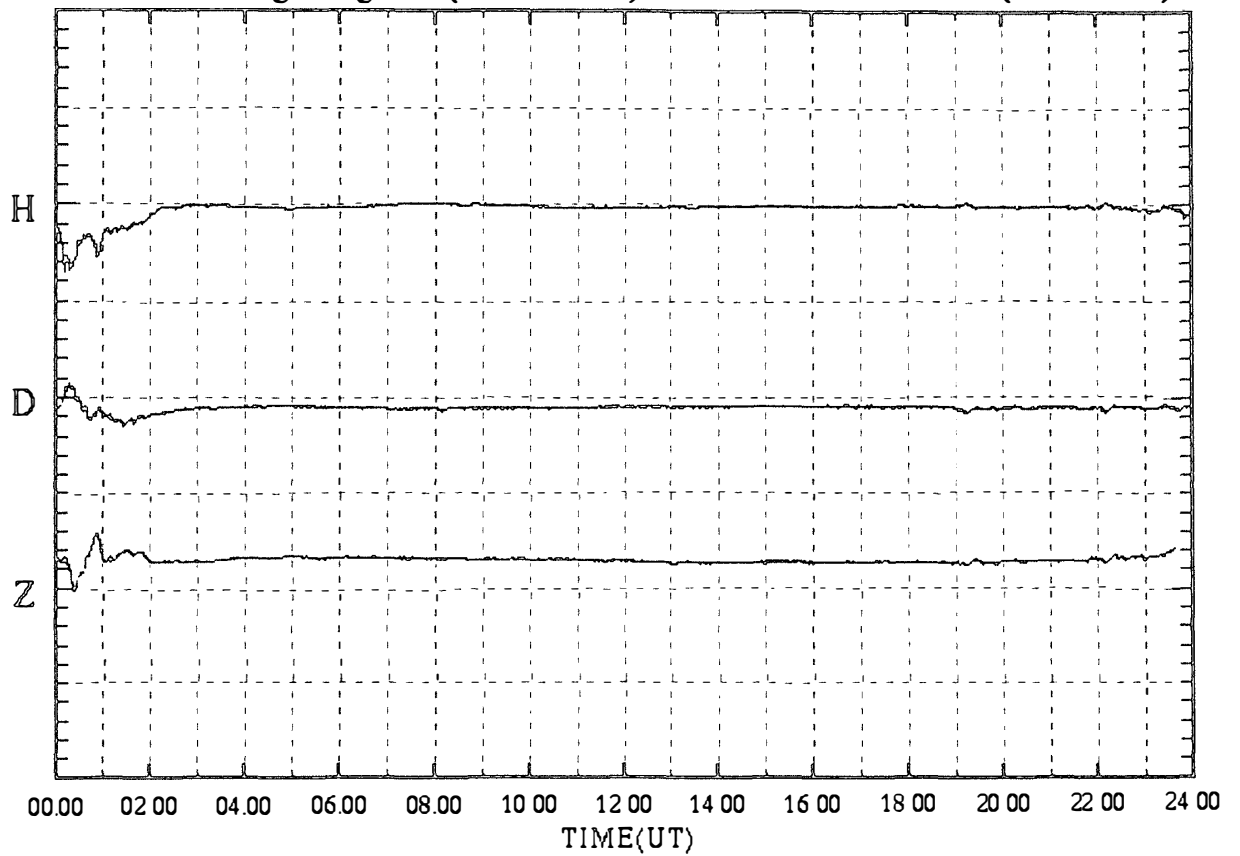

SYOWA magnetogram (100 nT/div)

10 Jul.1999 (DAY:191)

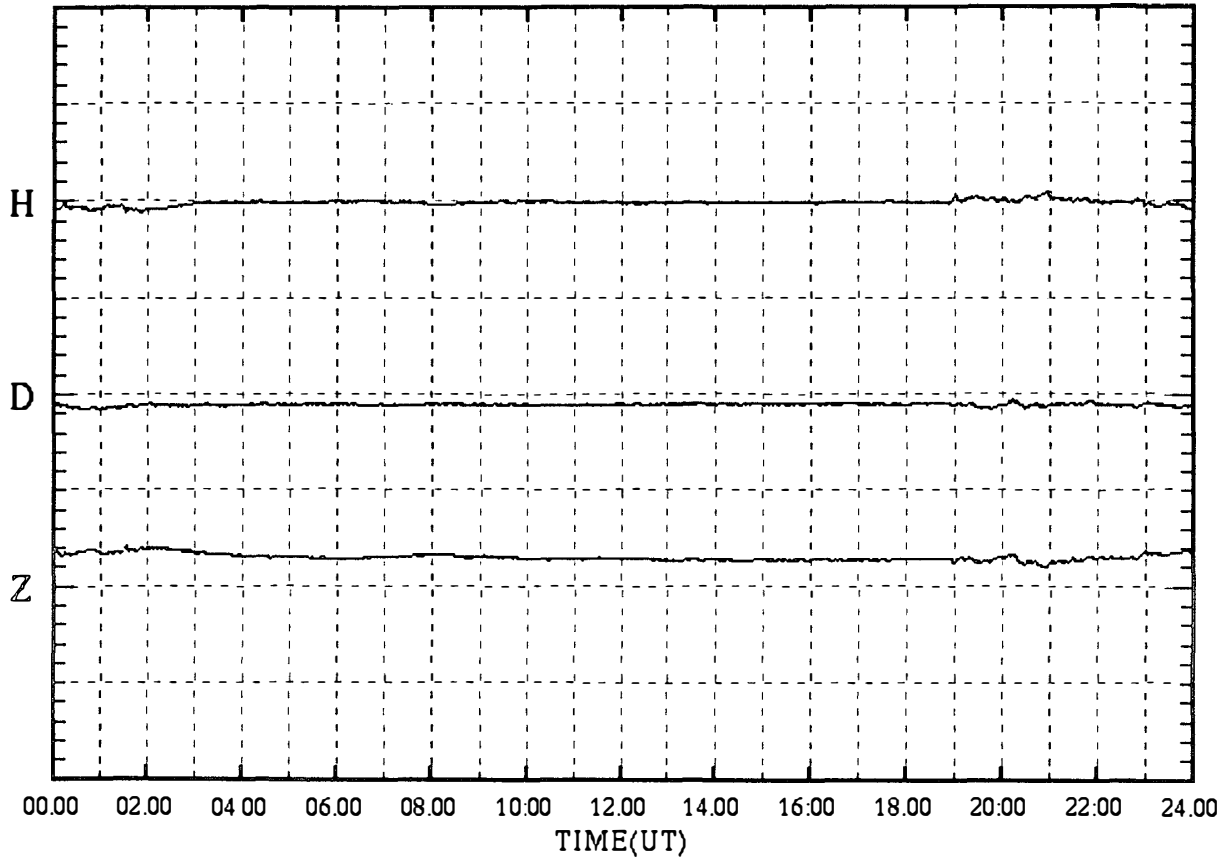

SYOWA magnetogram (100 nT/div)

11 Jul.1999 (DAY:192)

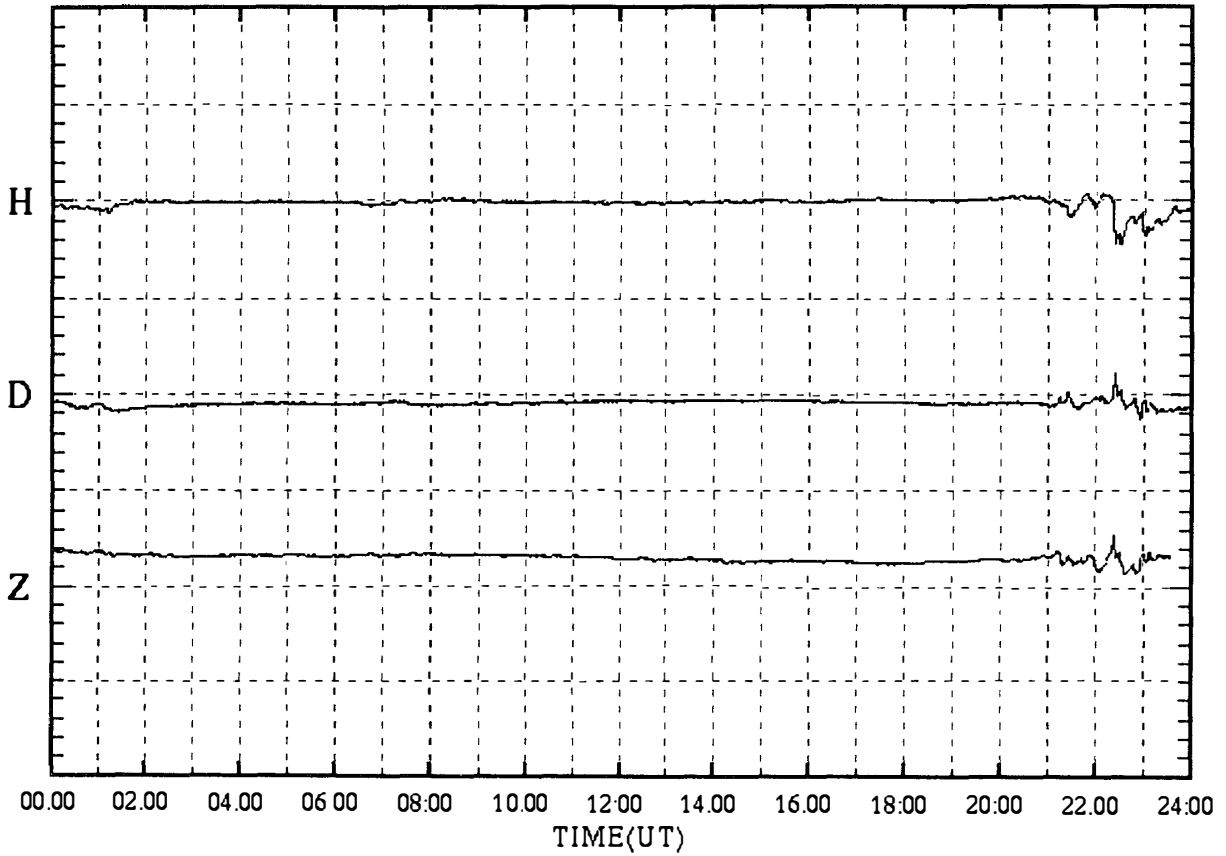



SYOWA magnetogram (100 nT/div)

12 Jul.1999 (DAY:193)

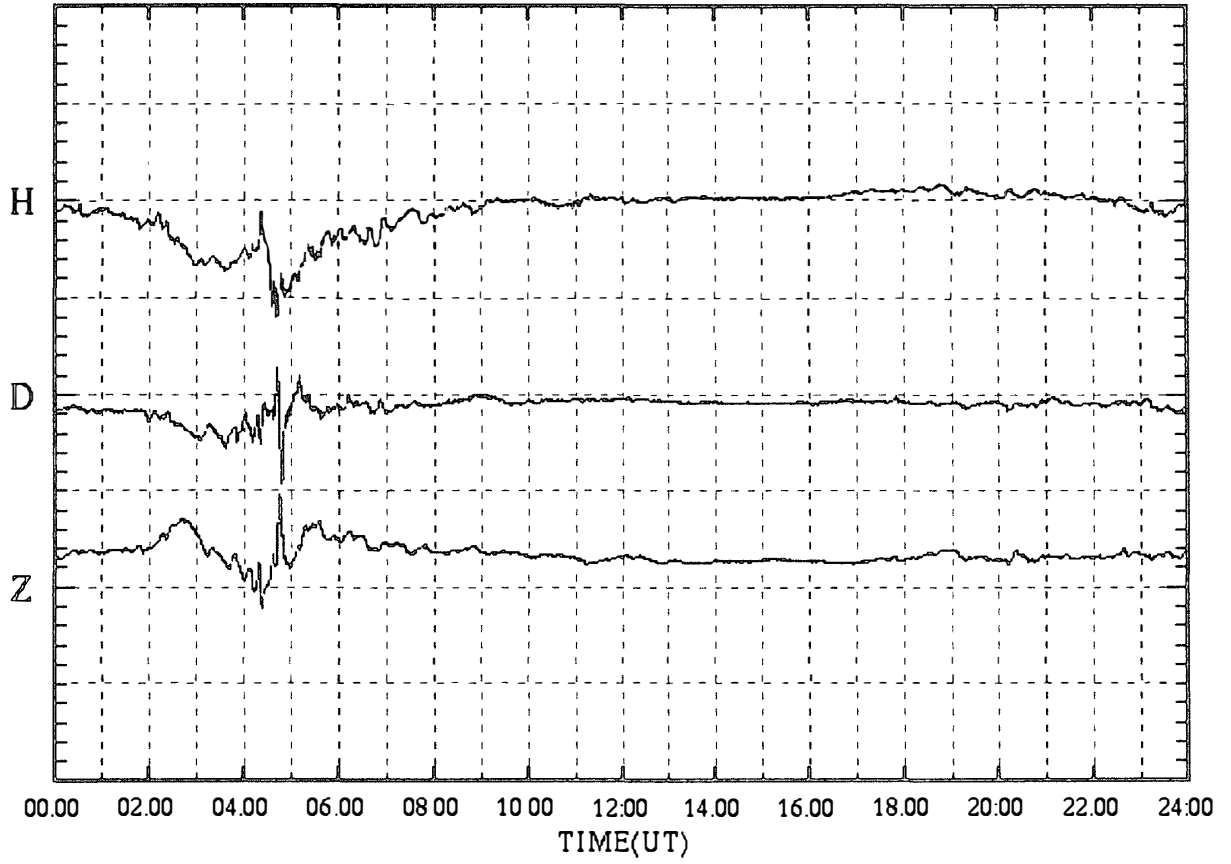

SYOWA magnetogram (100 nT/div)

13 Jul.1999 (DAY:194)

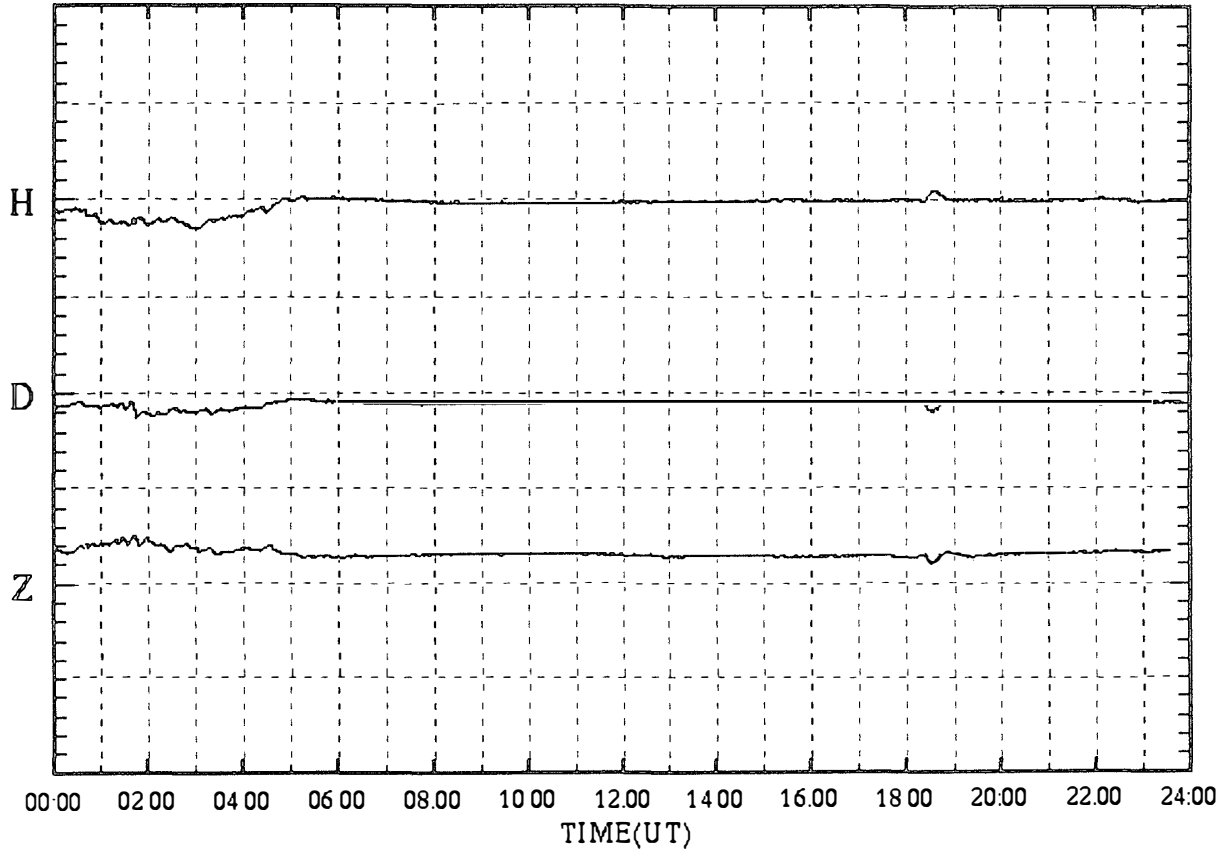

SYOWA magnetogram (100 nT/div)

14 Jul.1999 (DAY:195)

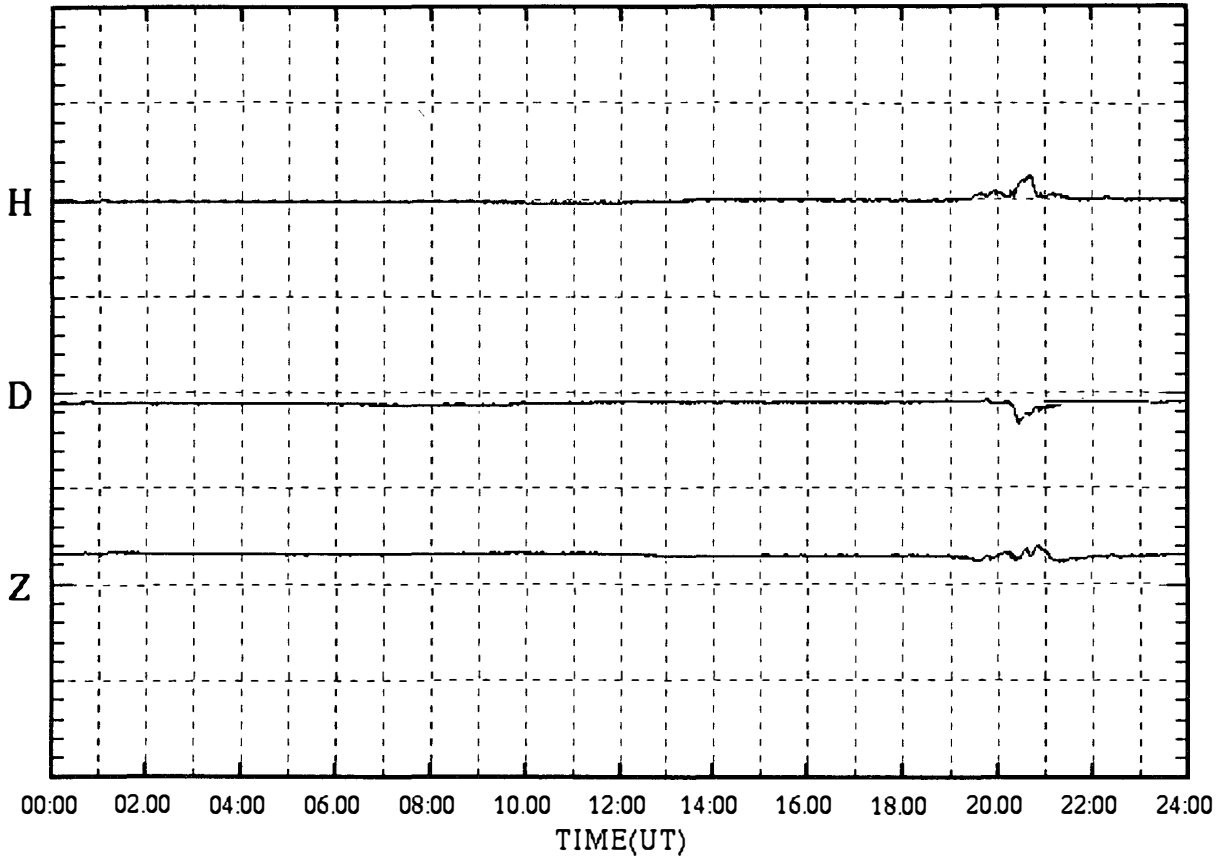

SYOWA magnetogram (100 nT/div)

15 Jul.1999 (DAY:196)

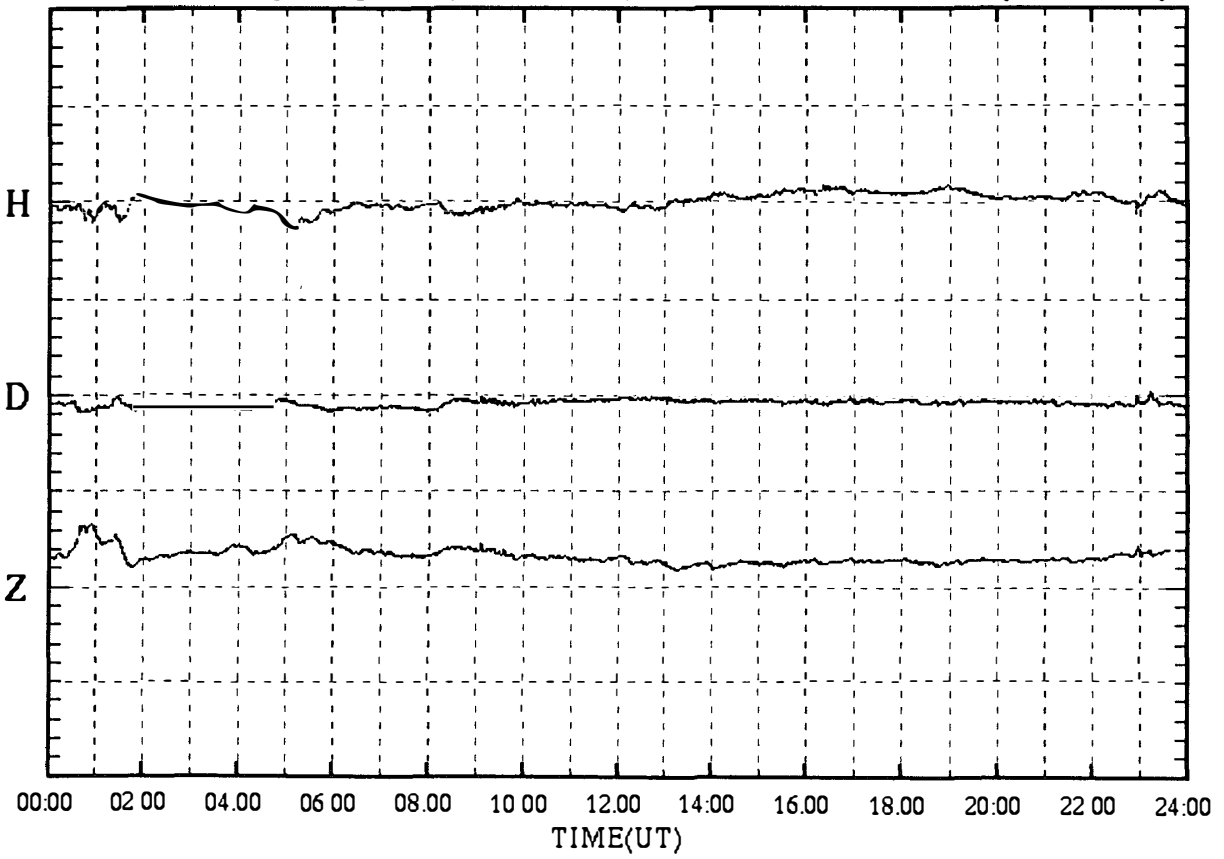

SYOWA magnetogram (100 nT/div)

16 Jul.1999 (DAY:197)

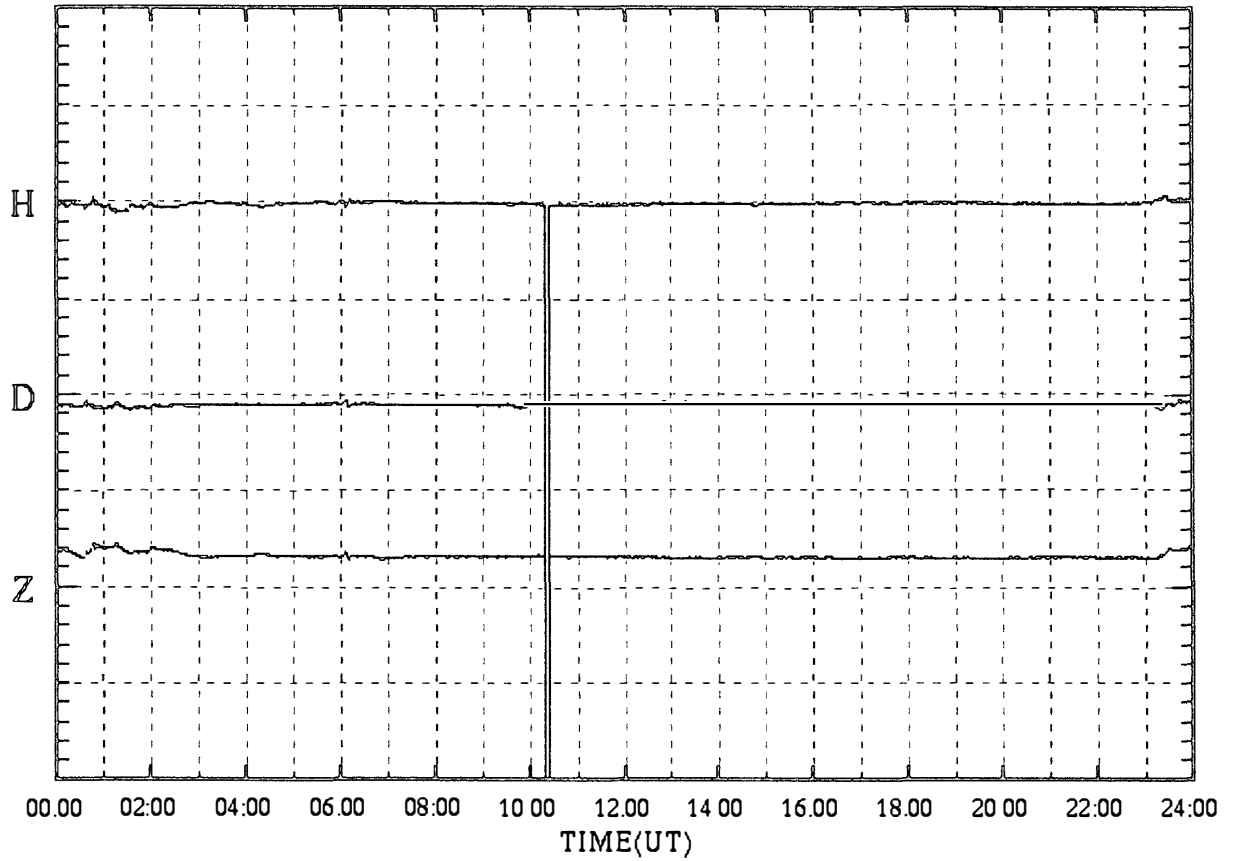

SYOWA magnetogram (100 nT/div)

17 Jul.1999 (DAY:198)

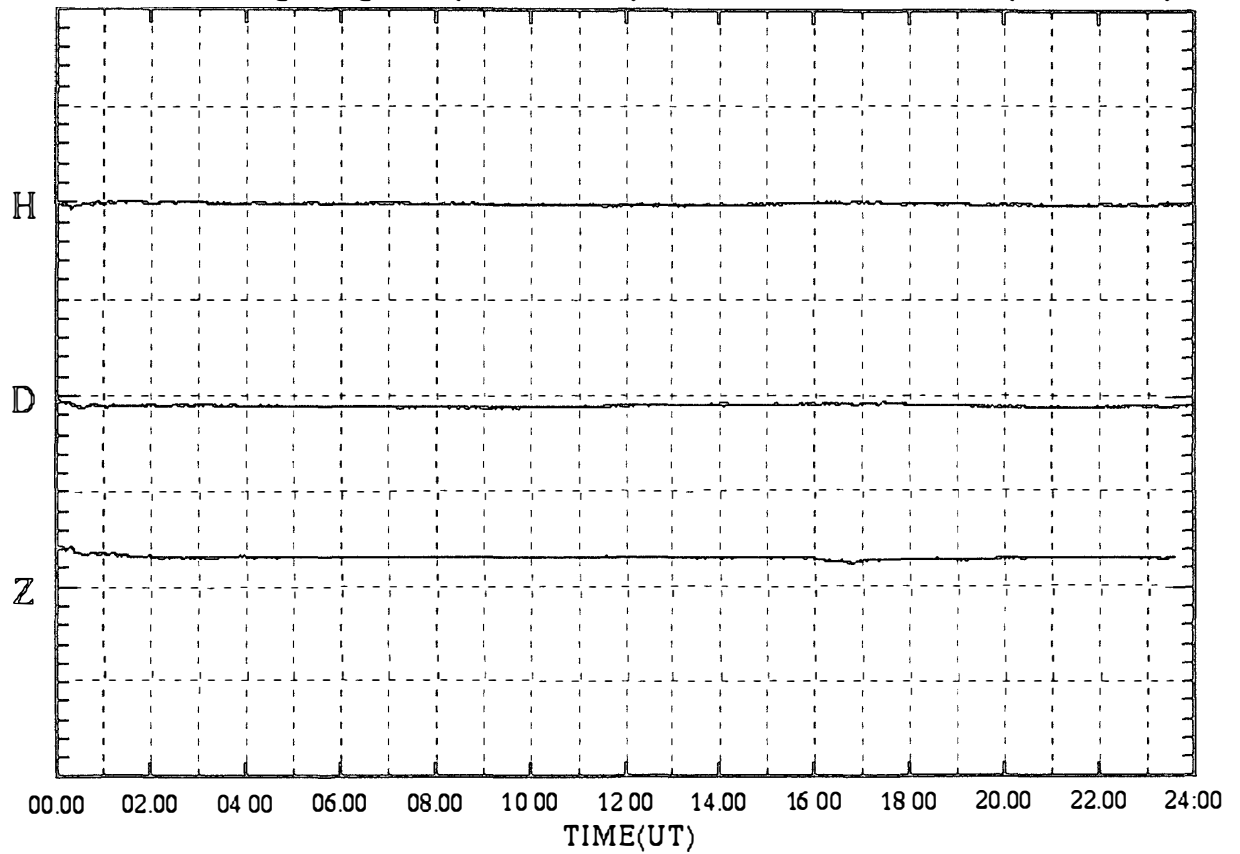

SYOWA magnetogram (100 nT/div)

18 Jul.1999 (DAY:199)

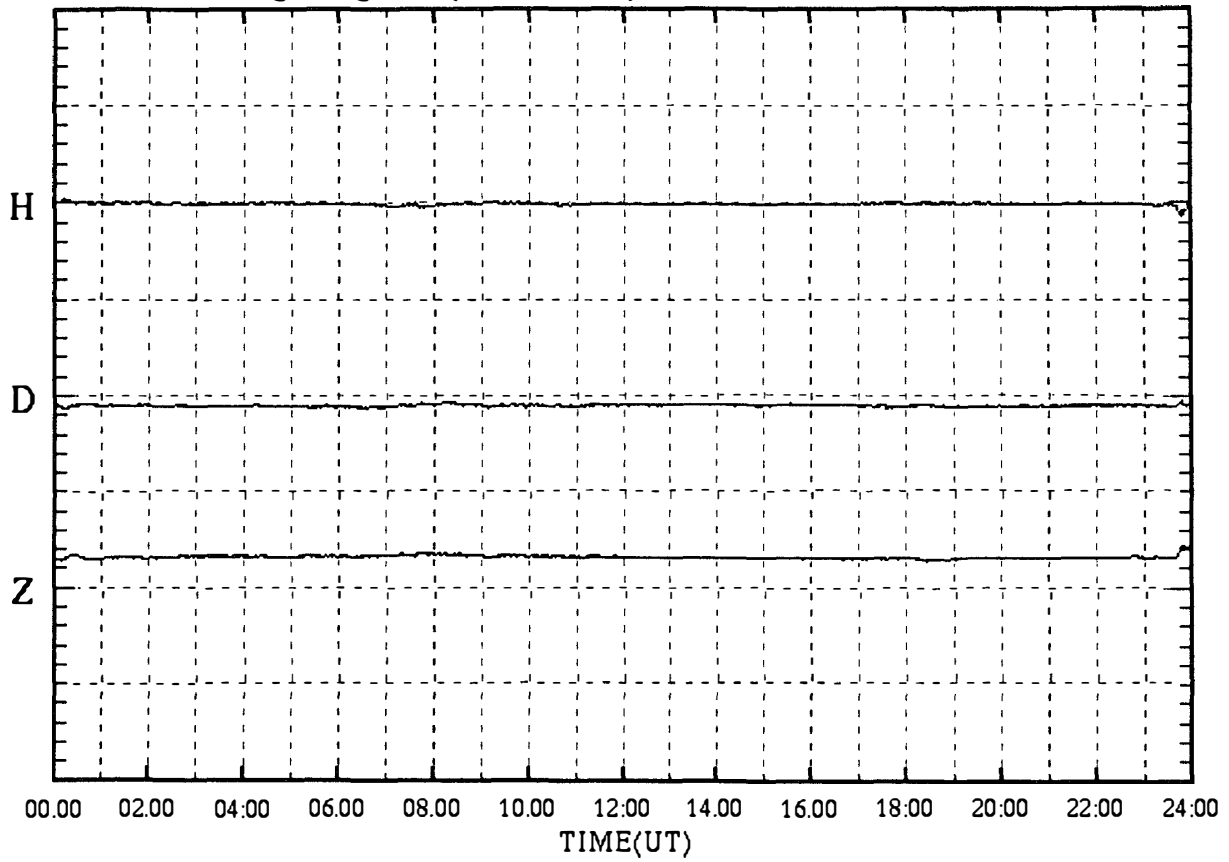

SYOWA magnetogram (100 nT/div)

19 Jul.1999 (DAY:200)

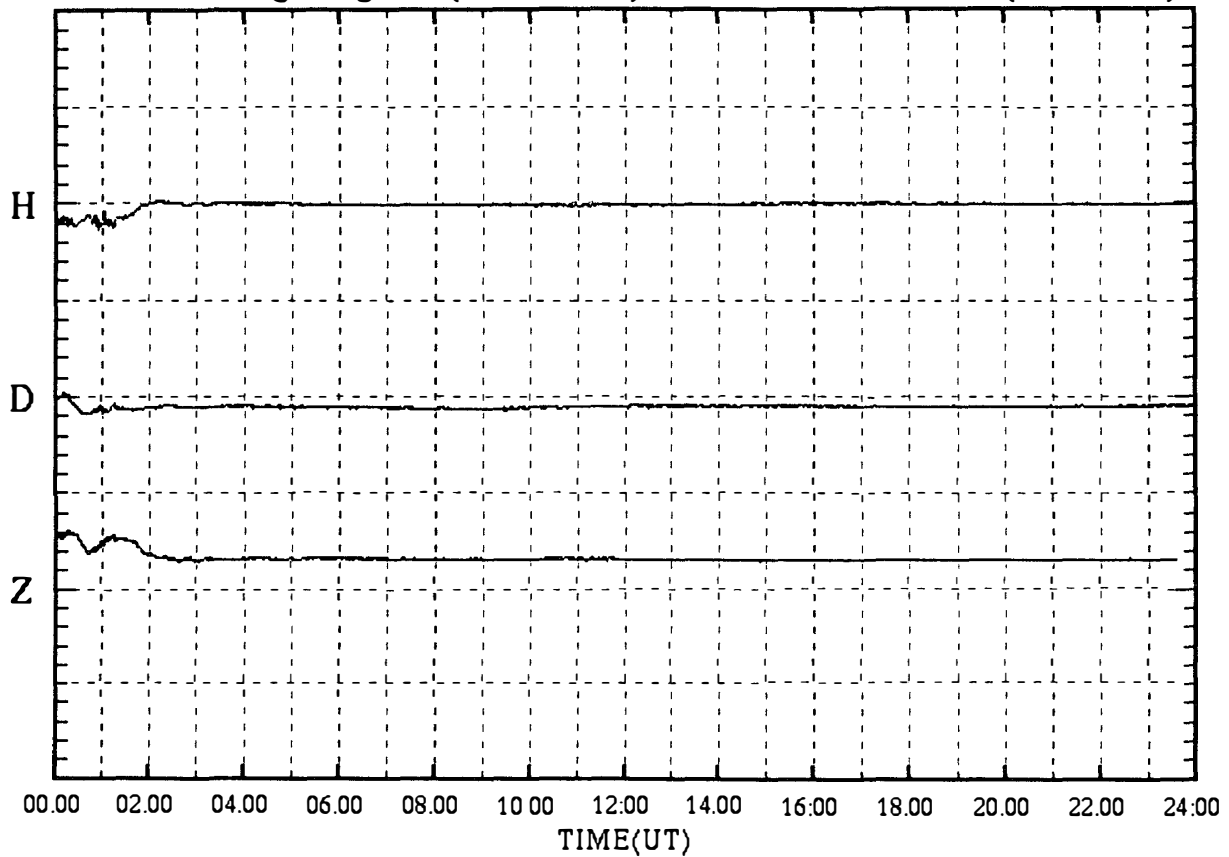

SYOWA magnetogram (100 nT/div)

20 Jul.1999 (DAY:201)

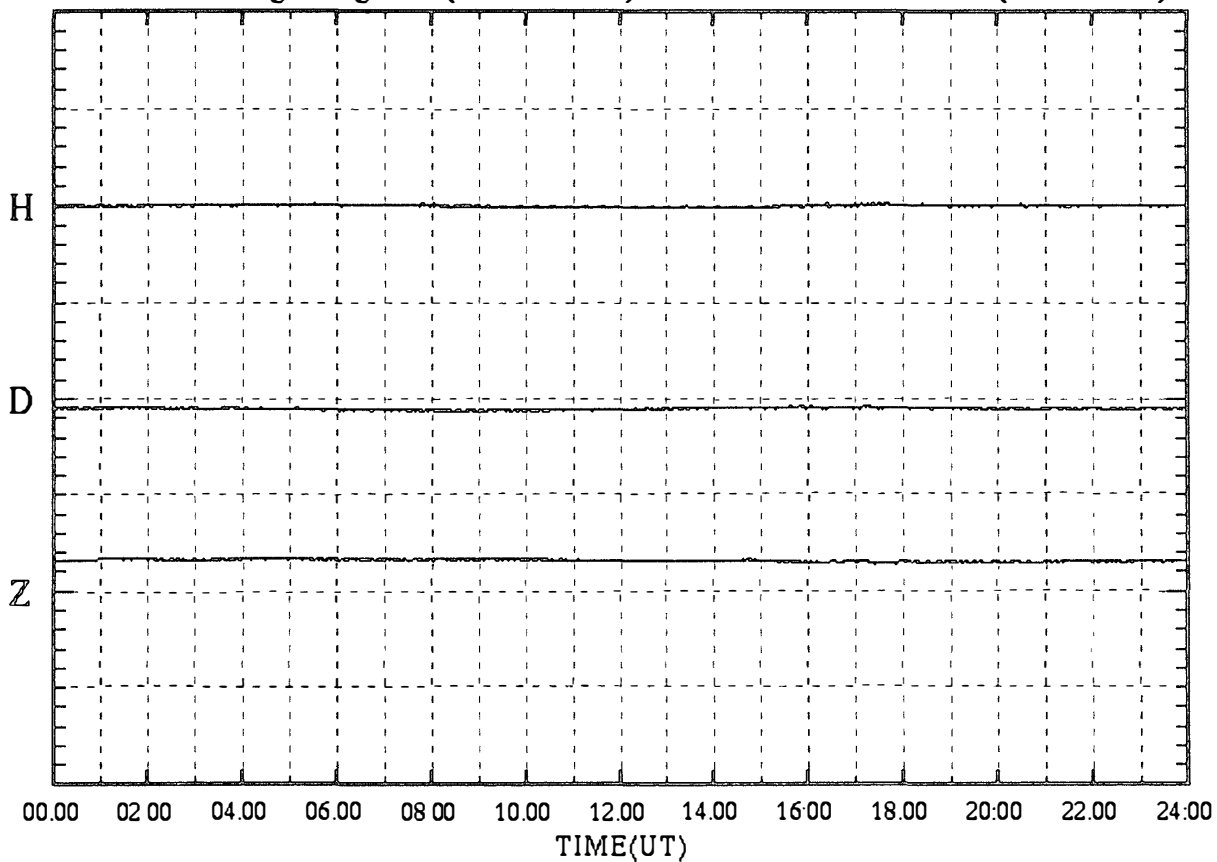

SYOWA magnetogram (100 nT/div)

21 Jul.1999 (DAY:202)

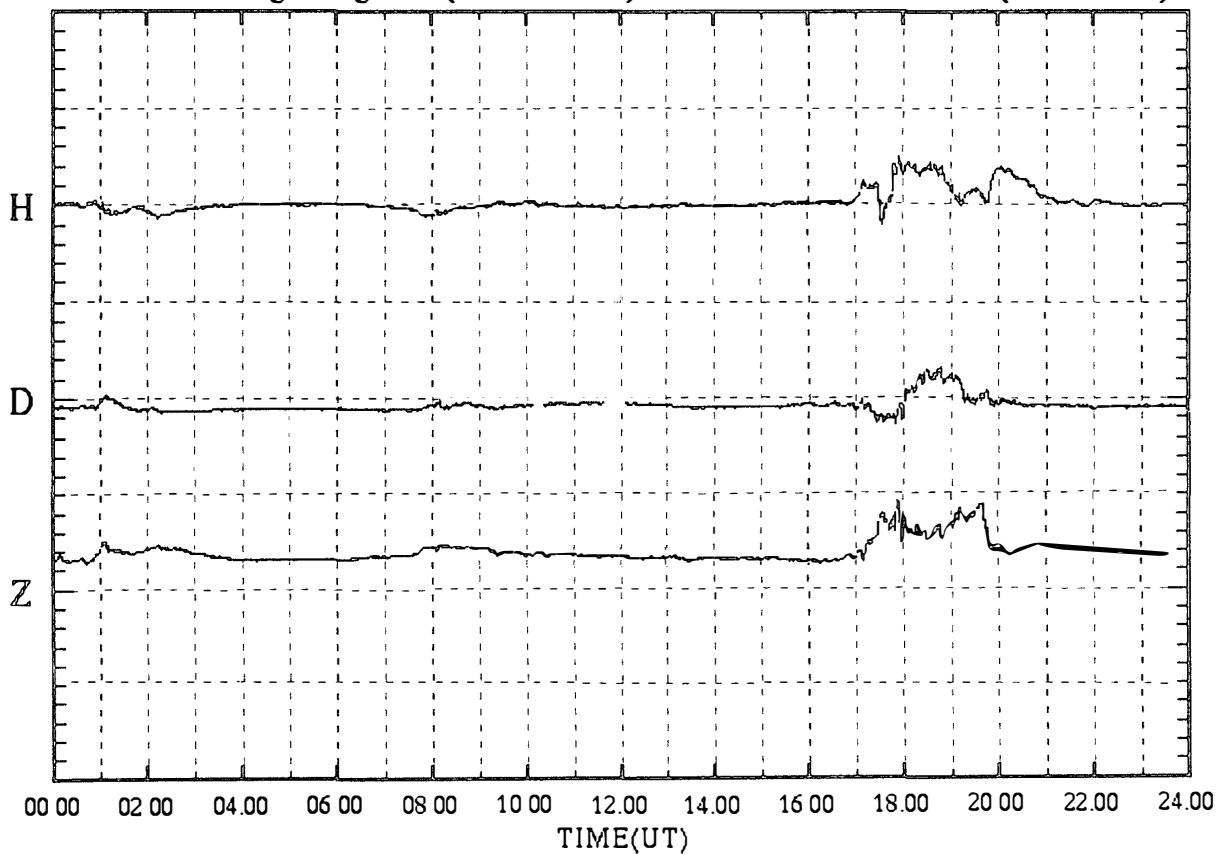

SYOWA magnetogram (100 nT/div)

22 Jul.1999 (DAY:203)

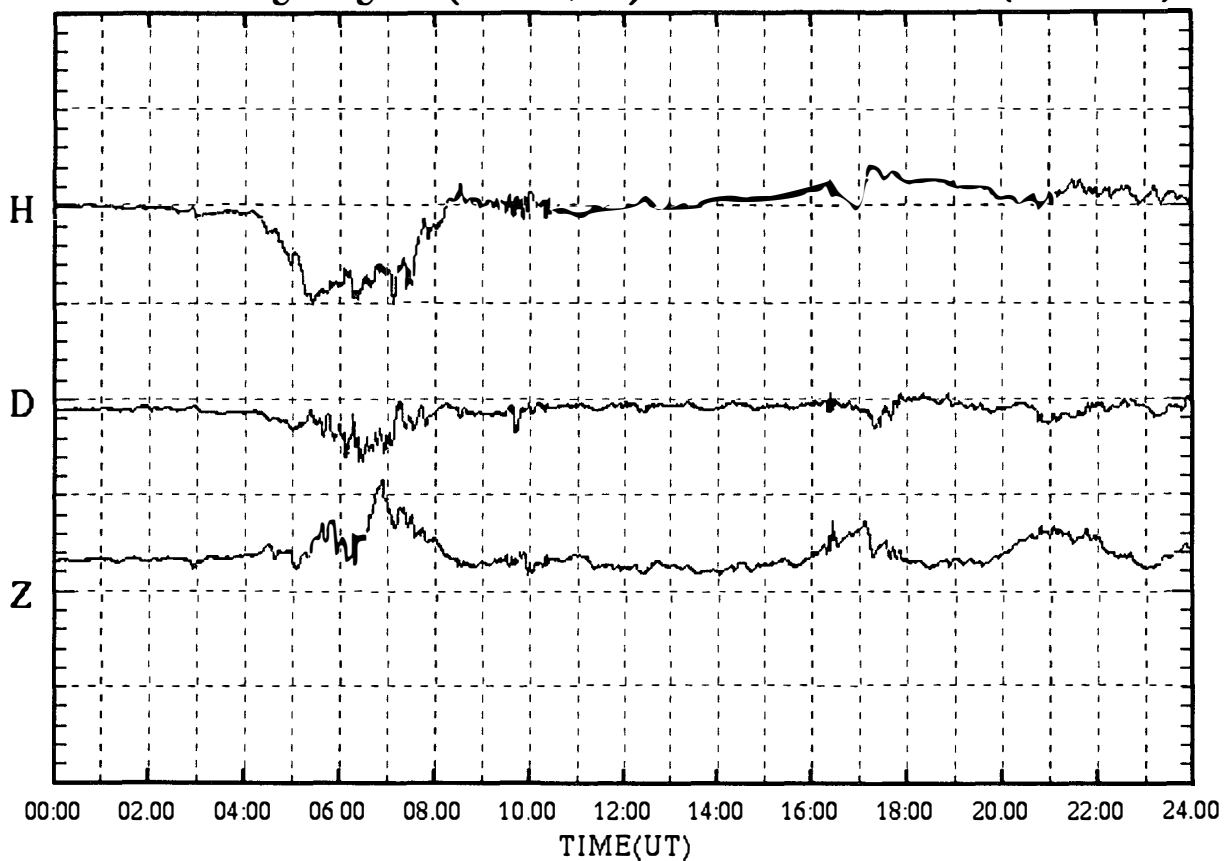

SYOWA magnetogram (100 nT/div)

23 Jul.1999 (DAY:204)

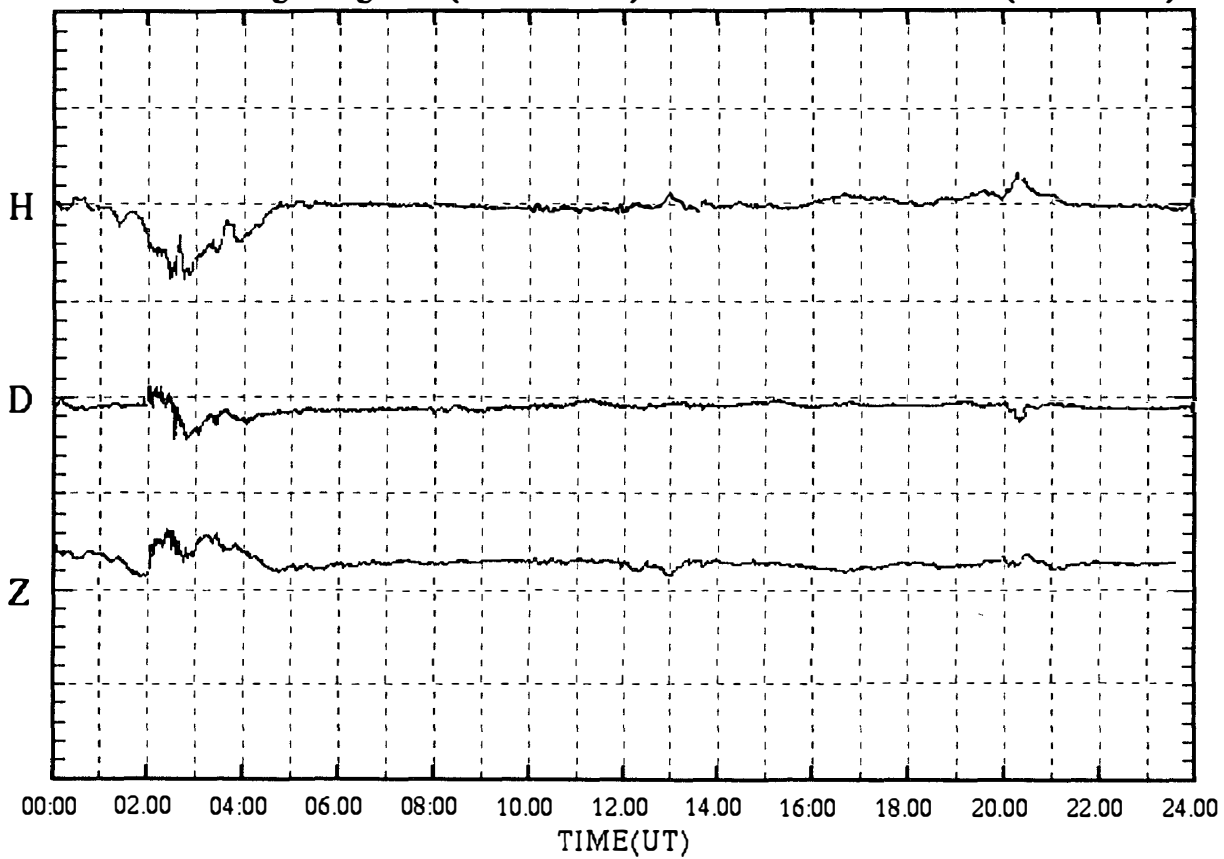

SYOWA magnetogram (100 nT/div)

24 Jul.1999 (DAY:205)

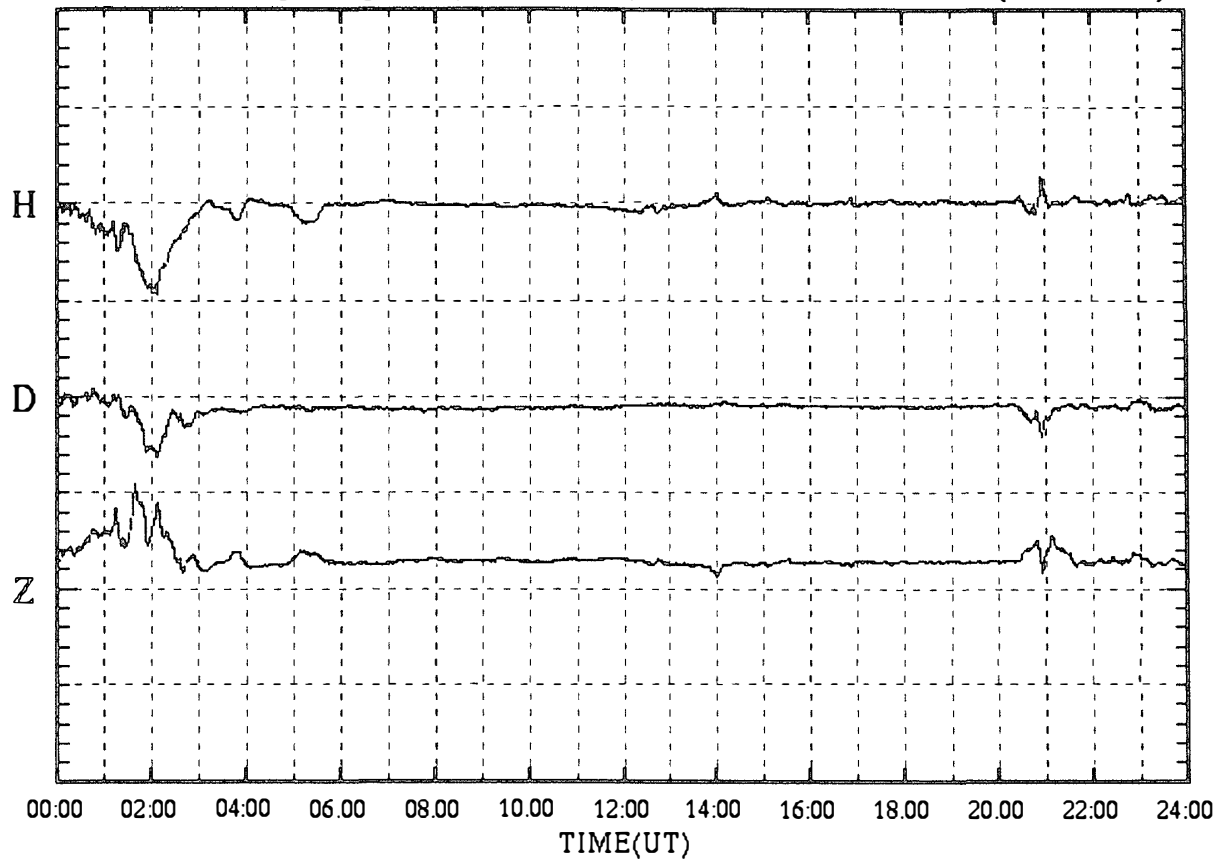

SYOWA magnetogram (100 nT/div)

25 Jul.1999 (DAY:206)

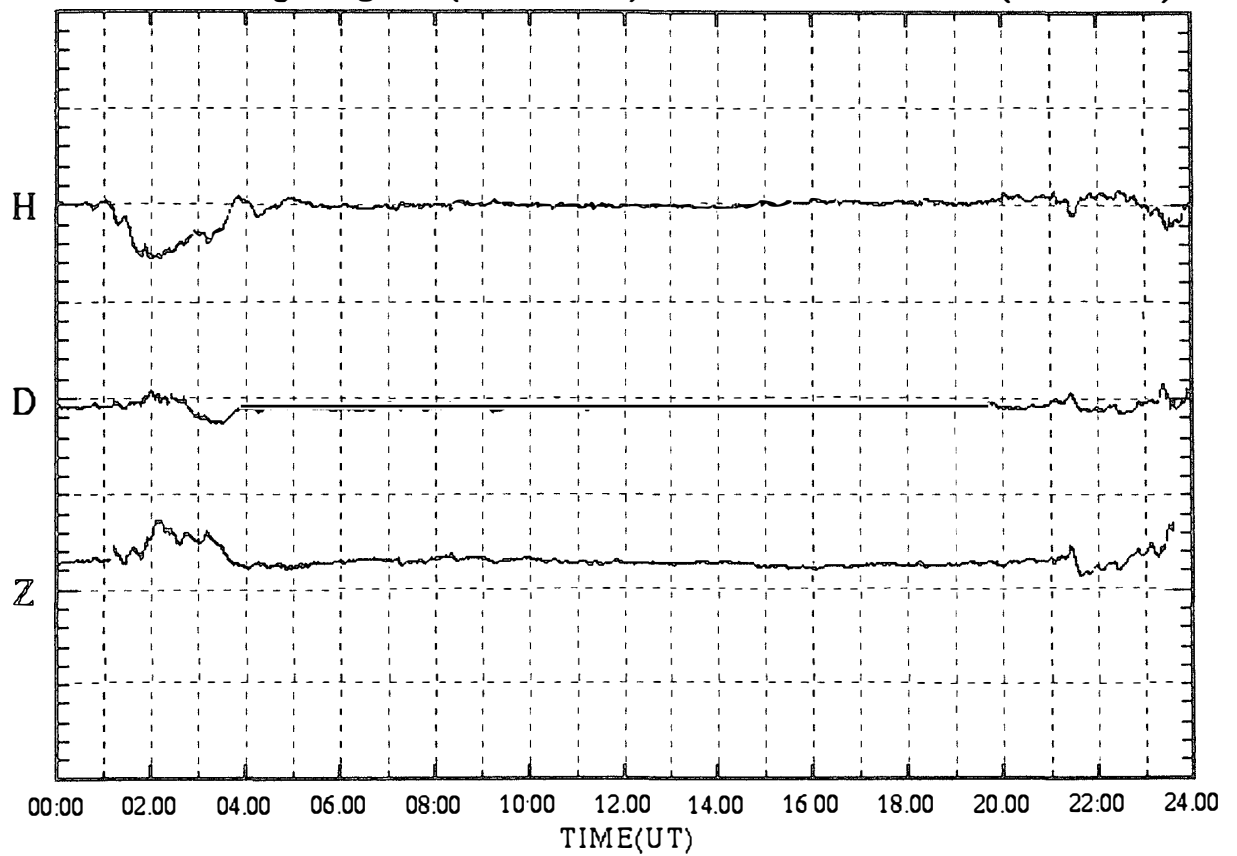

SYOWA magnetogram (100 nT/div)

26 Jul.1999 (DAY:207)

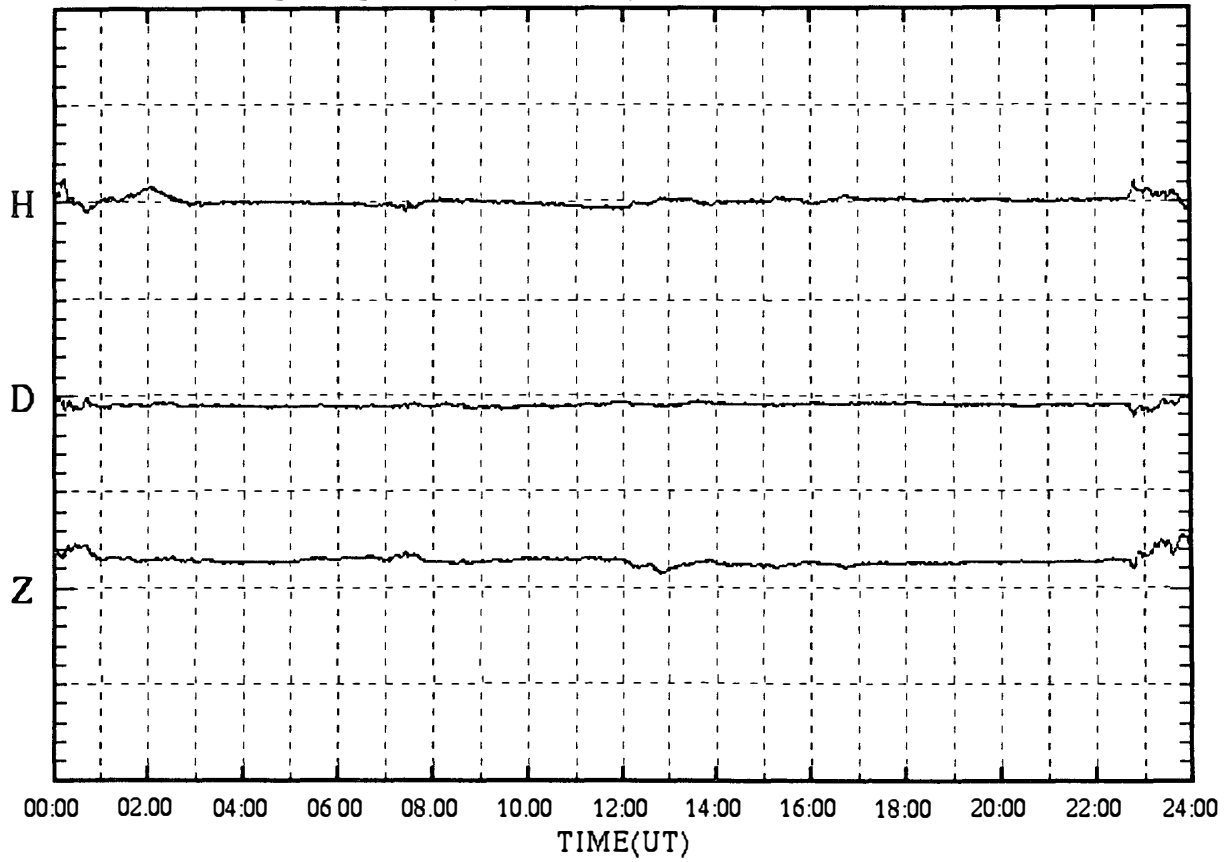

SYOWA magnetogram (100 nT/div)

27 Jul.1999 (DAY:208)

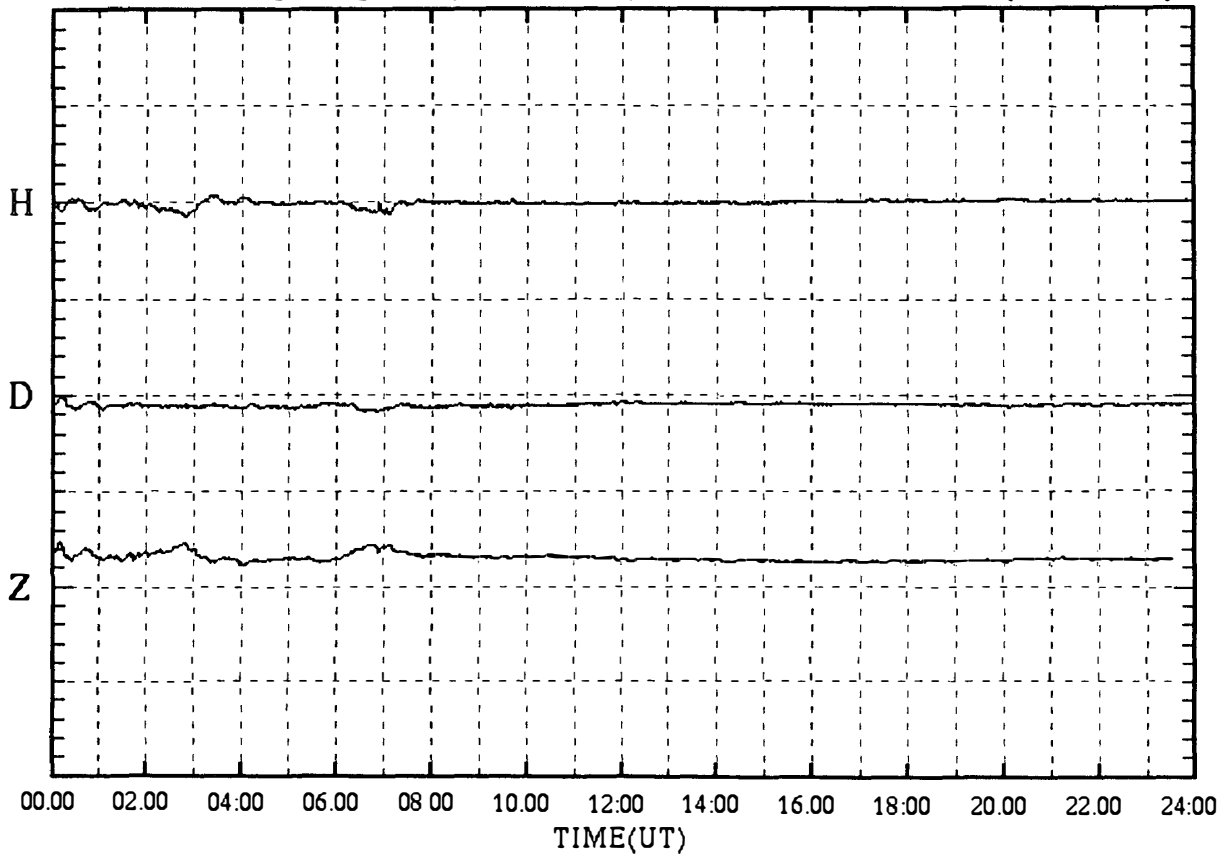



SYOWA magnetogram (100 nT/div)

28 Jul.1999 (DAY:209)

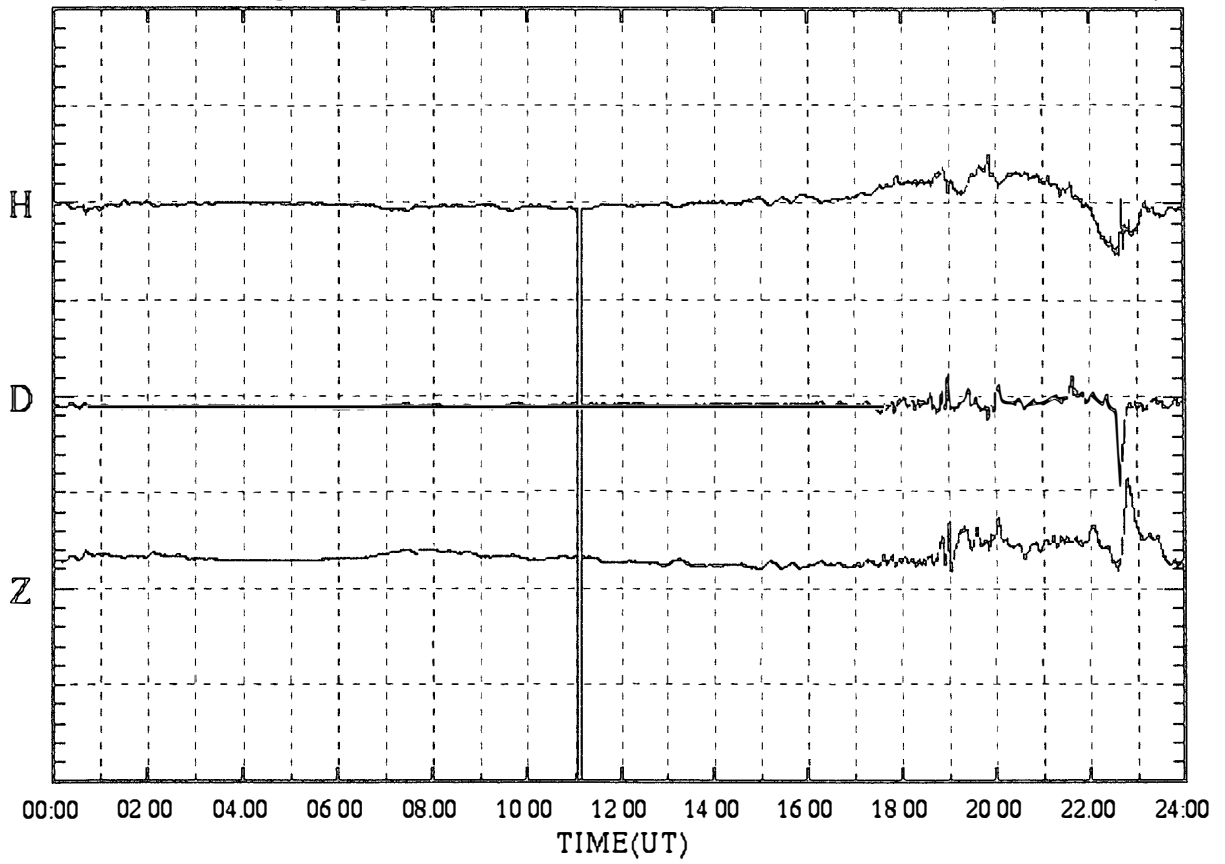

SYOWA magnetogram (100 nT/div)

29 Jul.1999 (DAY:210)

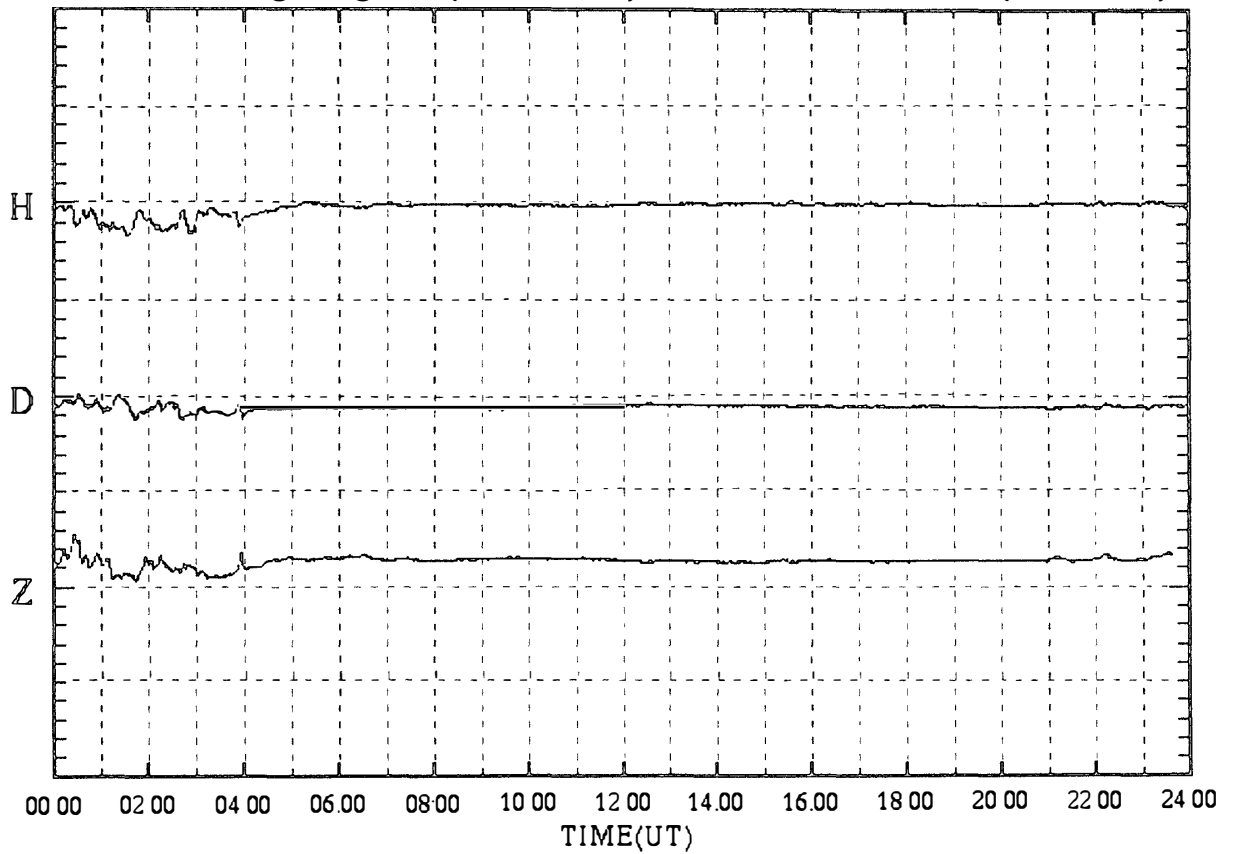

SYOWA magnetogram (100 nT/div)

30 Jul.1999 (DAY:211)

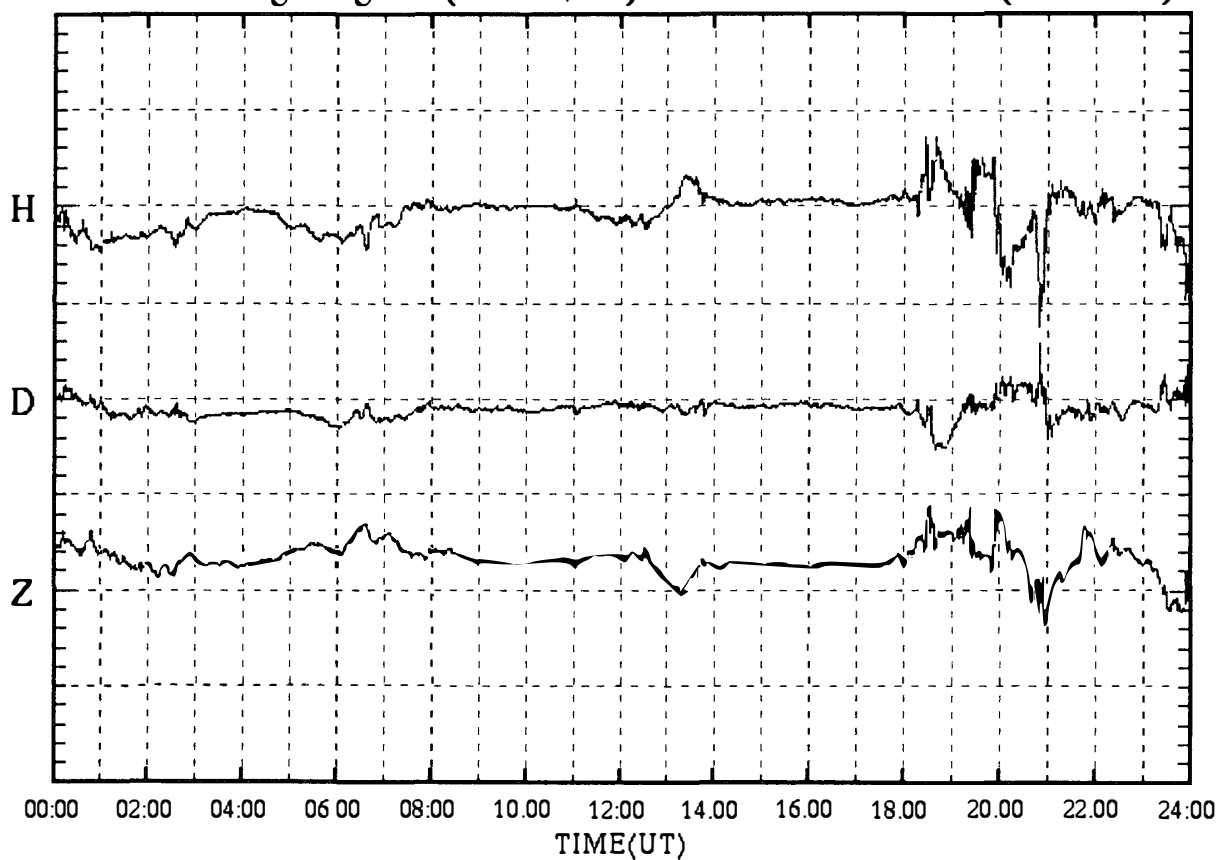

SYOWA magnetogram (100 nT/div)

31 Jul.1999 (DAY:212)

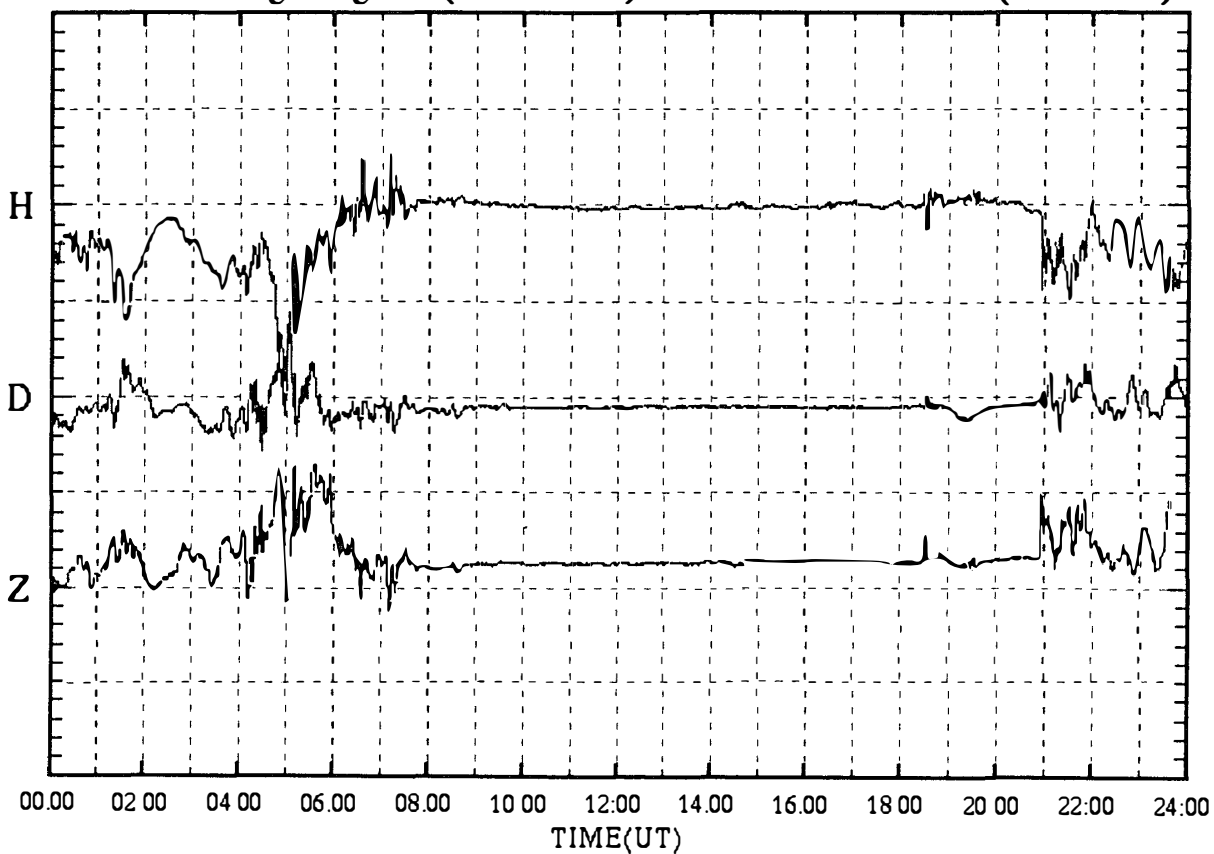

SYOWA magnetogram (100 nT/div)

01 Aug.1999 (DAY:213)

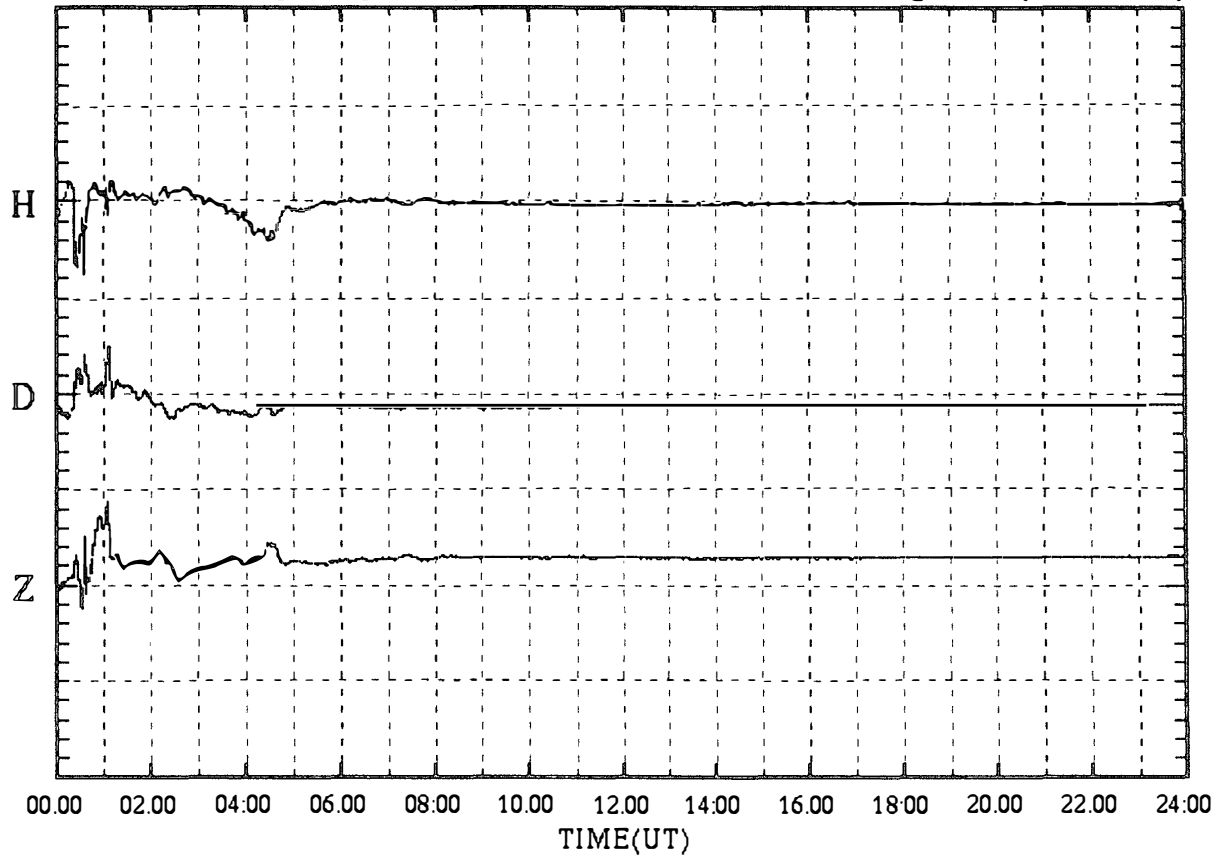

SYOWA magnetogram (100 nT/div)

02 Aug.1999 (DAY:214)

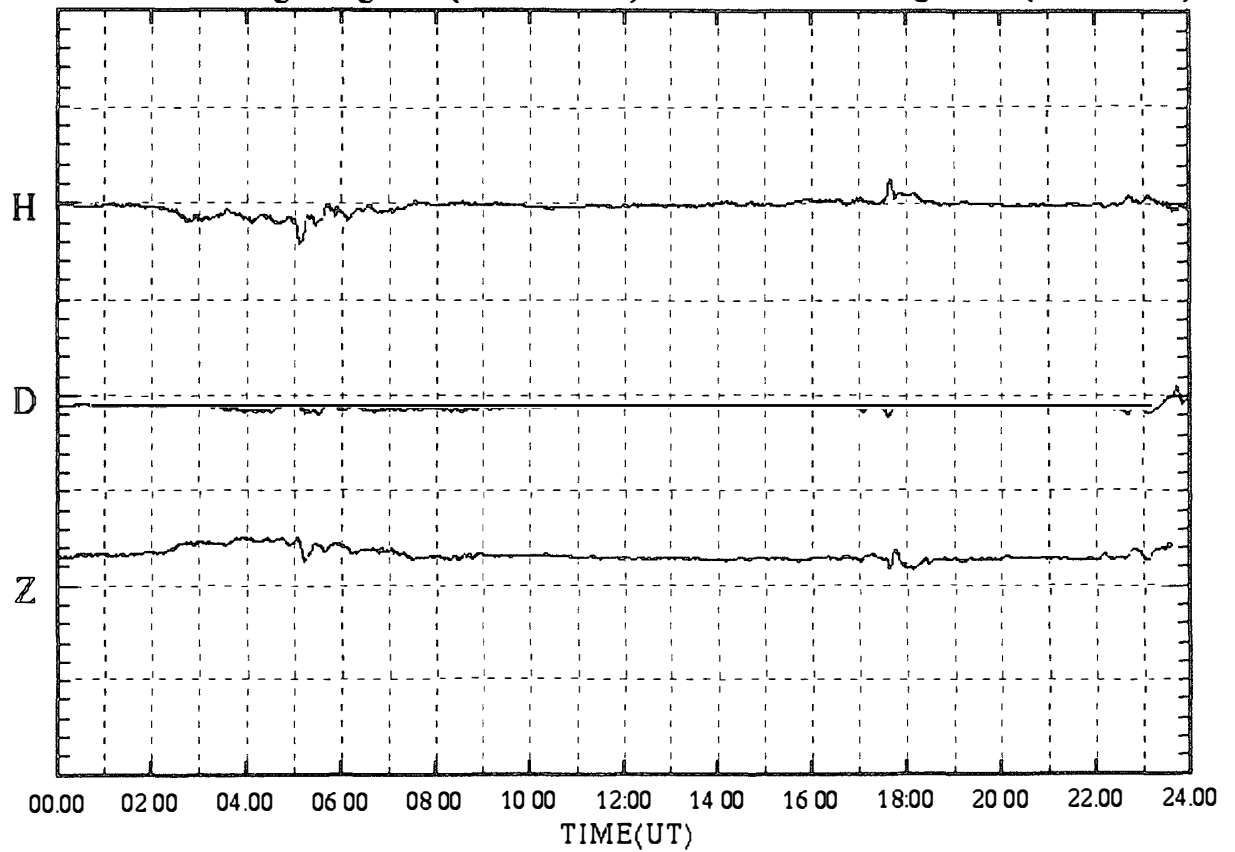

SYOWA magnetogram (100 nT/div)

03 Aug.1999 (DAY:215)

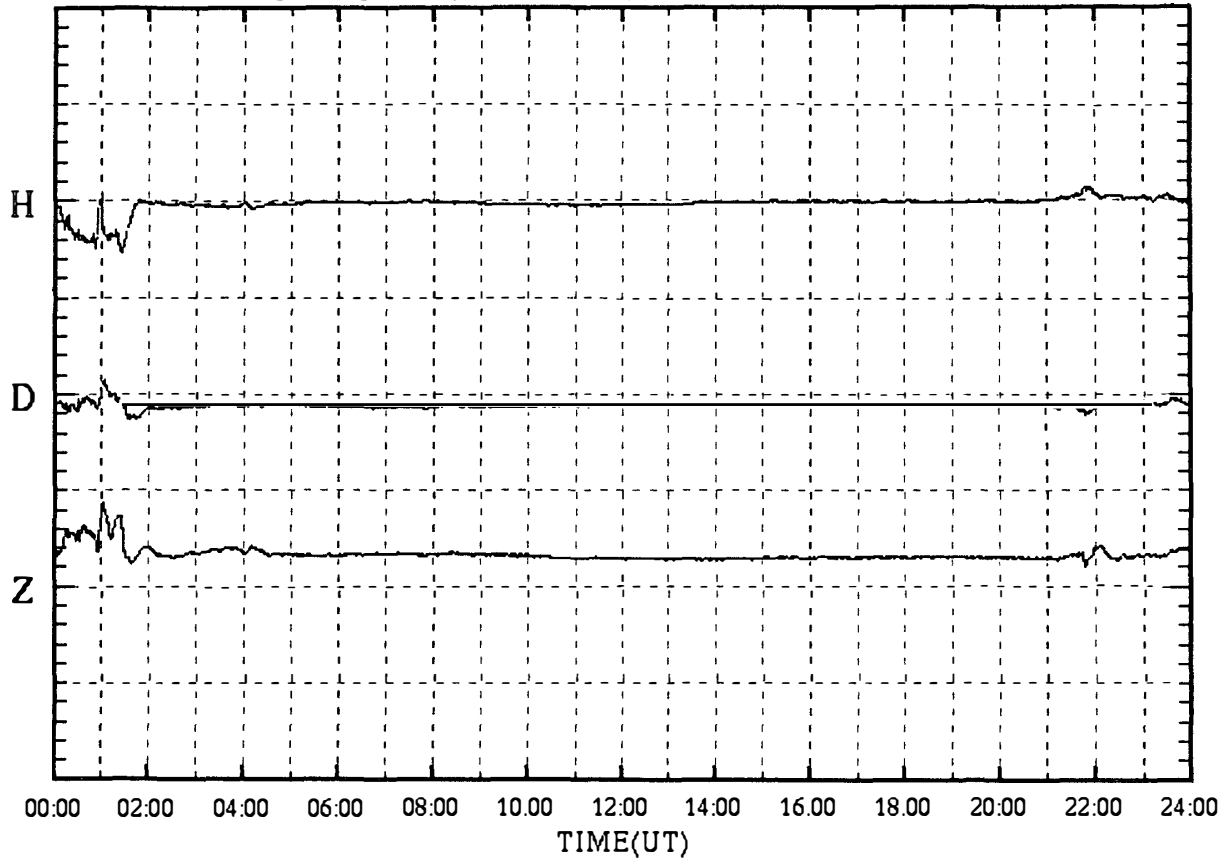

SYOWA magnetogram (100 nT/div)

04 Aug.1999 (DAY:216)

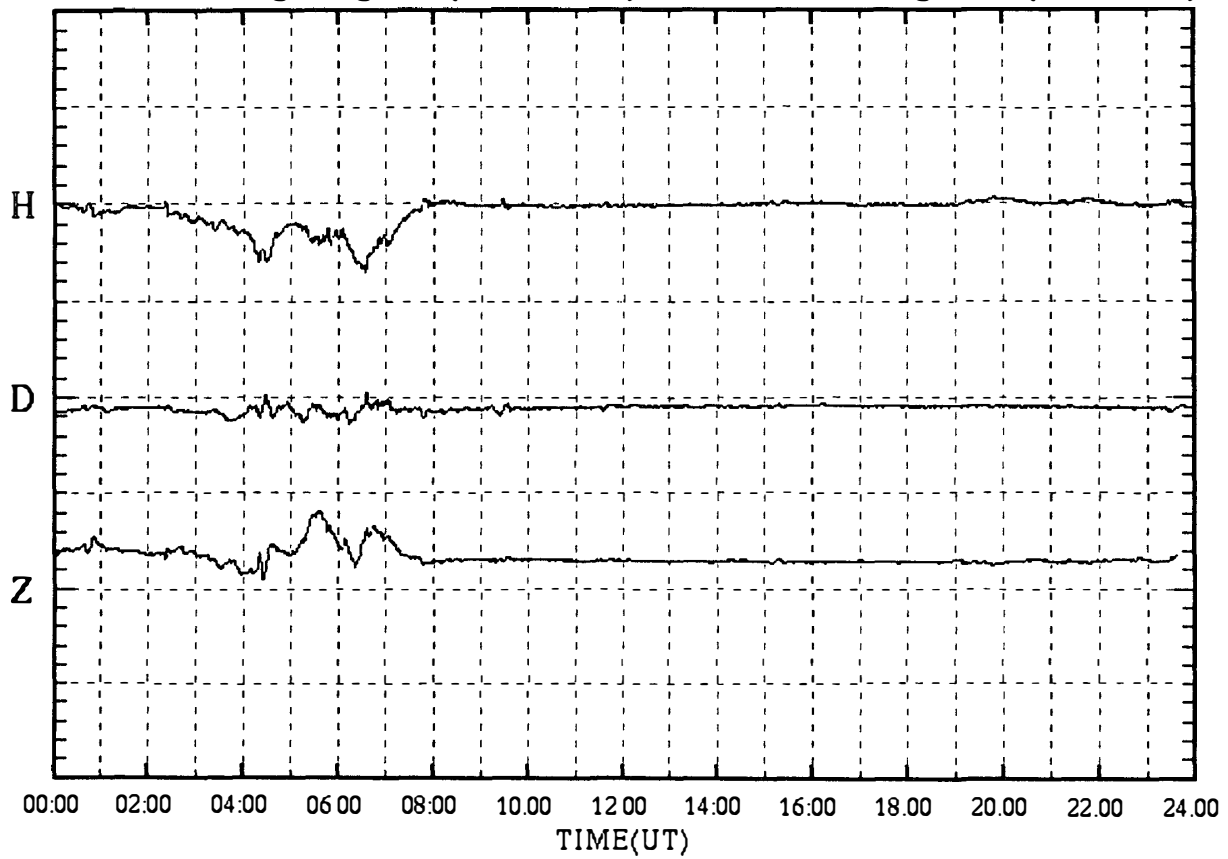

SYOWA magnetogram (100 nT/div)

05 Aug.1999 (DAY:217)

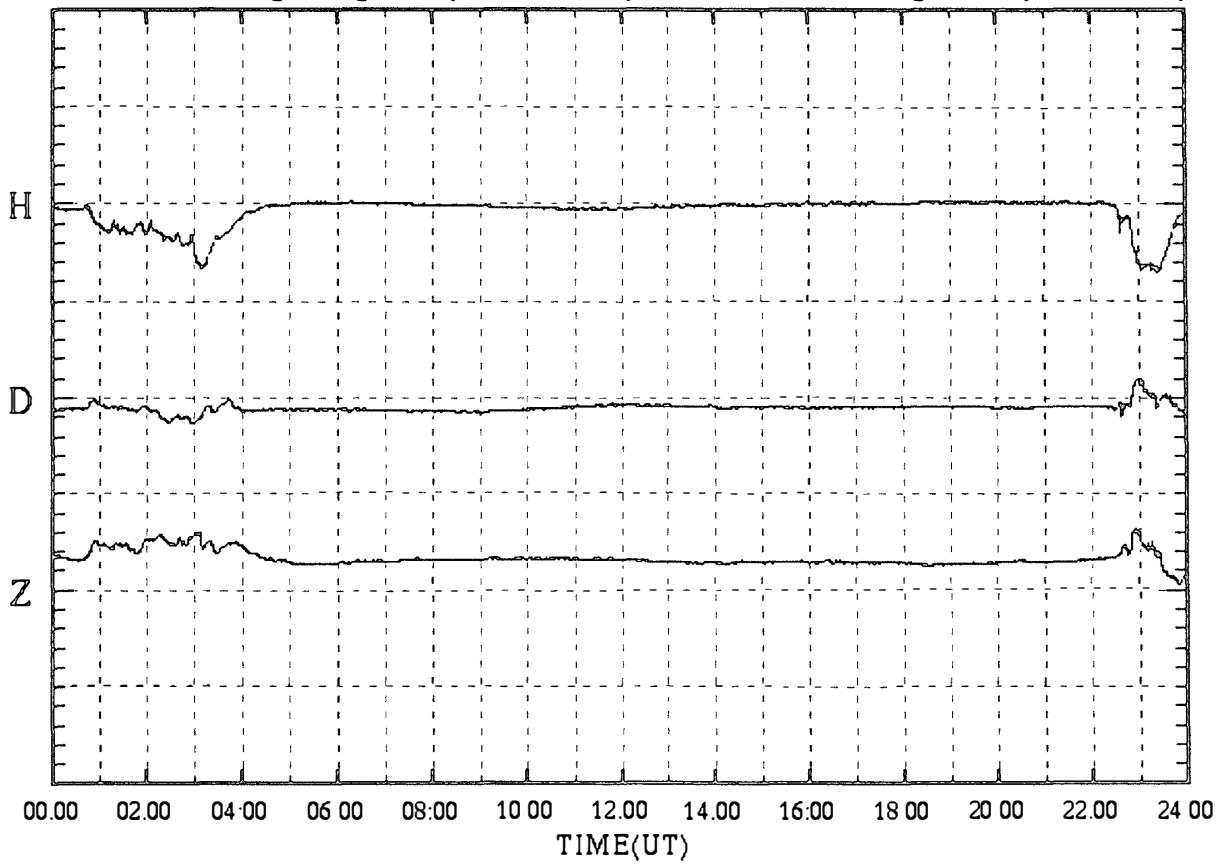

SYOWA magnetogram (100 nT/div)

06 Aug.1999 (DAY:218)

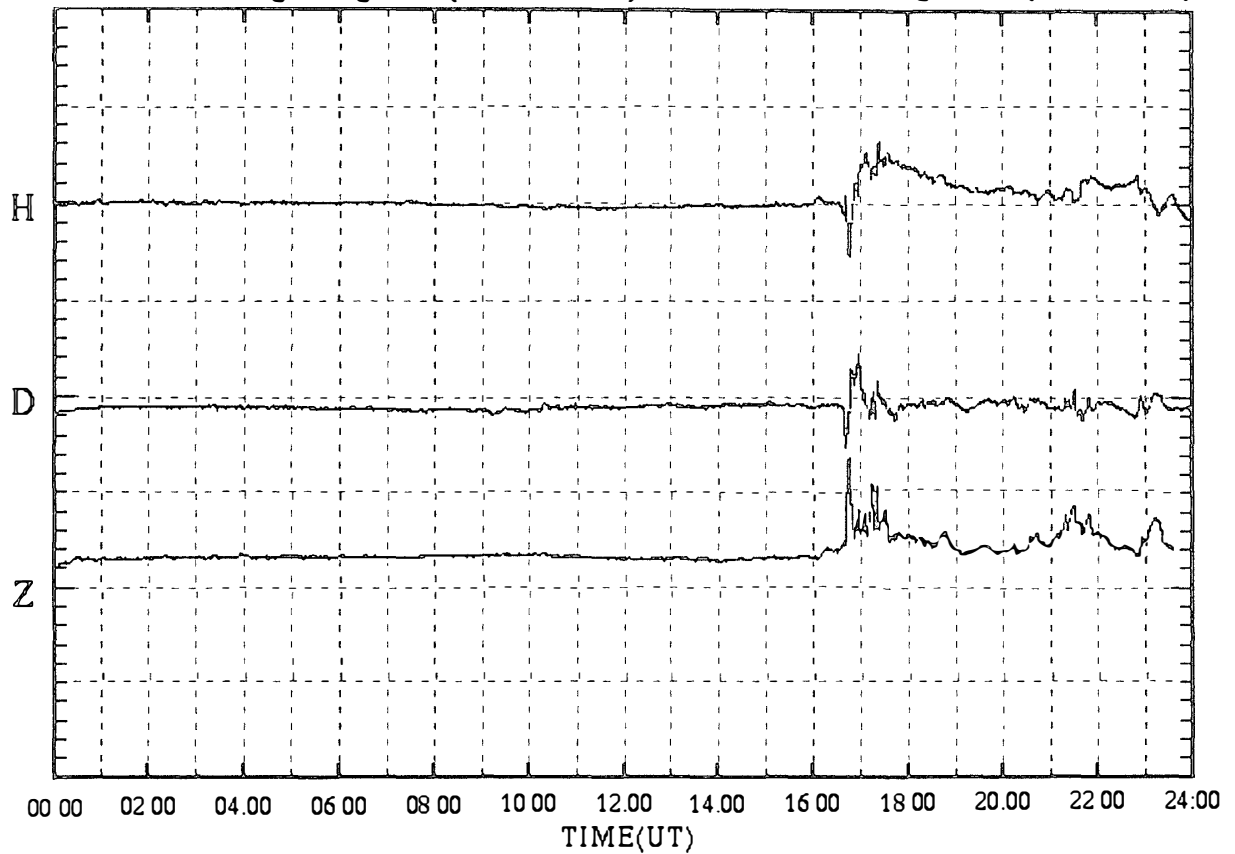

SYOWA magnetogram (100 nT/div)

07 Aug.1999 (DAY:219)

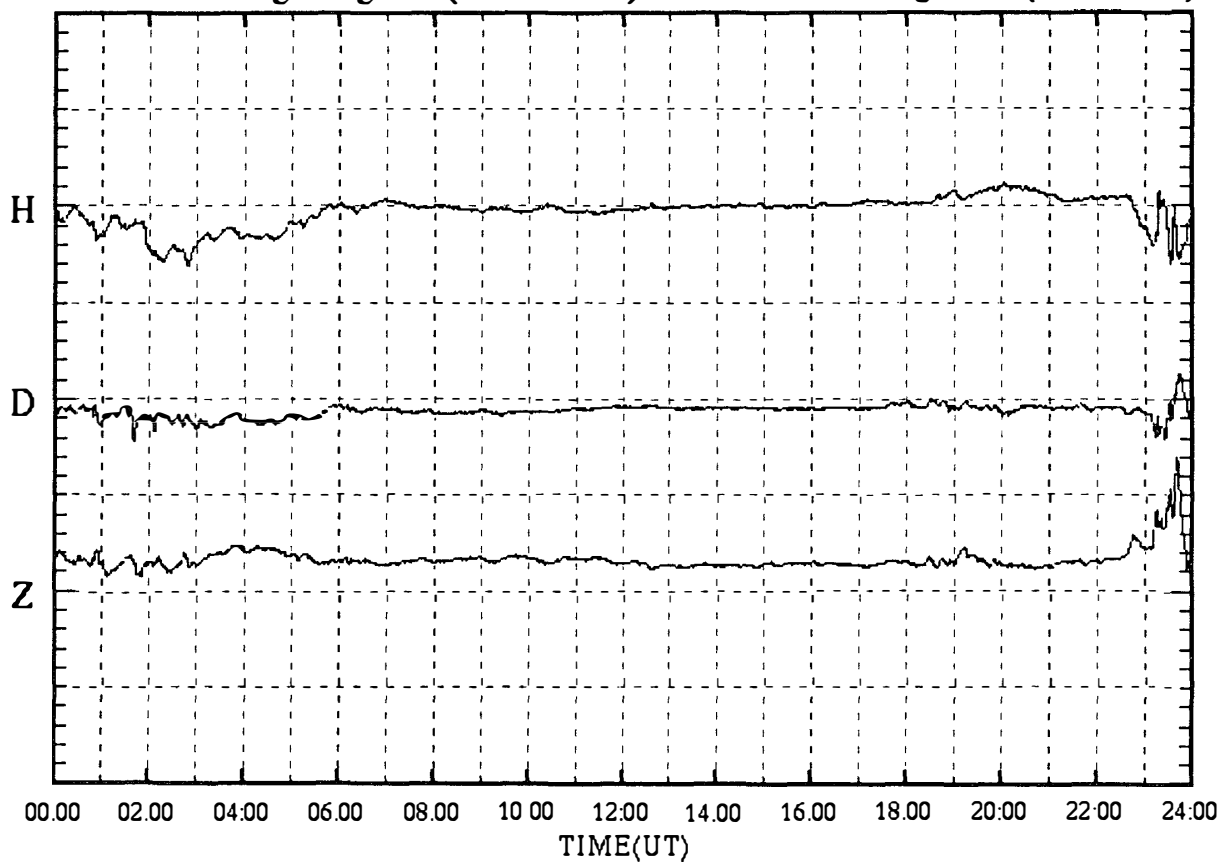

SYOWA magnetogram (100 nT/div)

08 Aug.1999 (DAY:220)

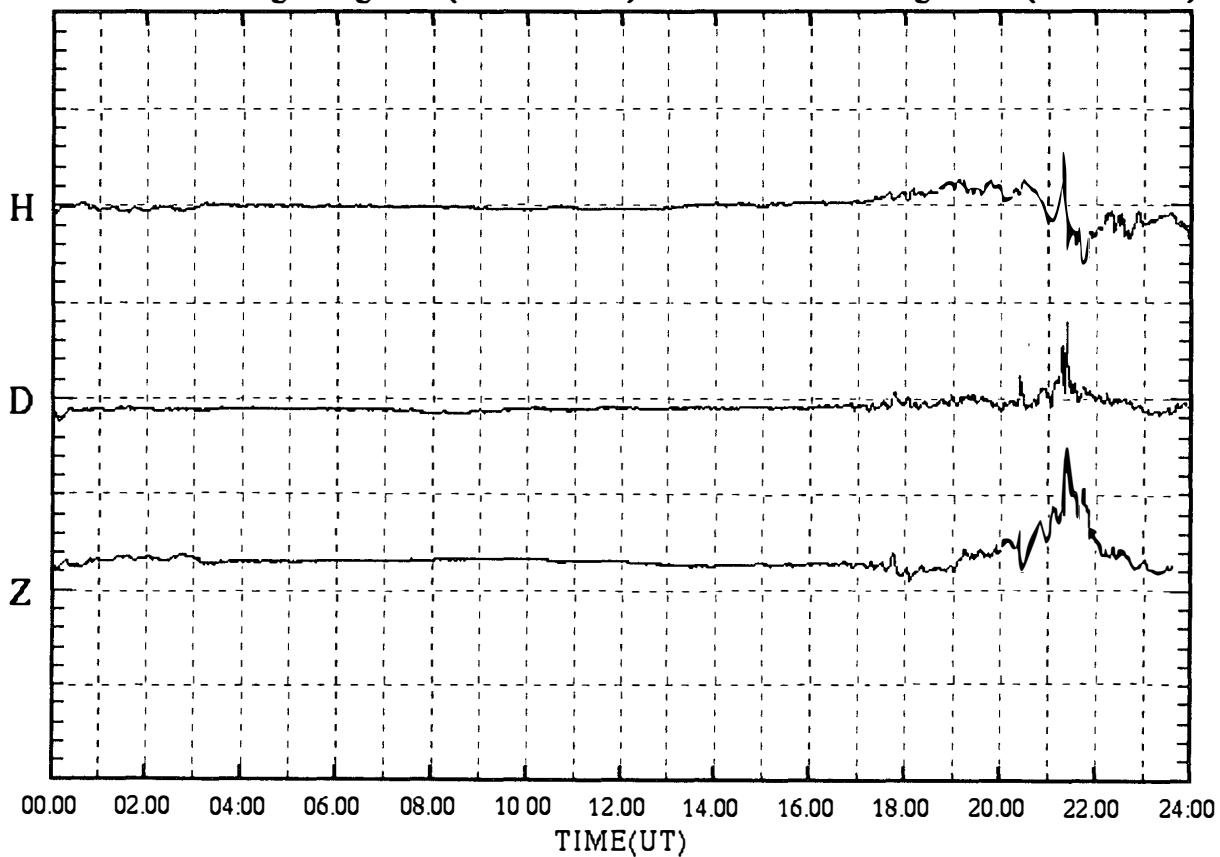

SYOWA magnetogram (100 nT/div)

09 Aug.1999 (DAY:221)

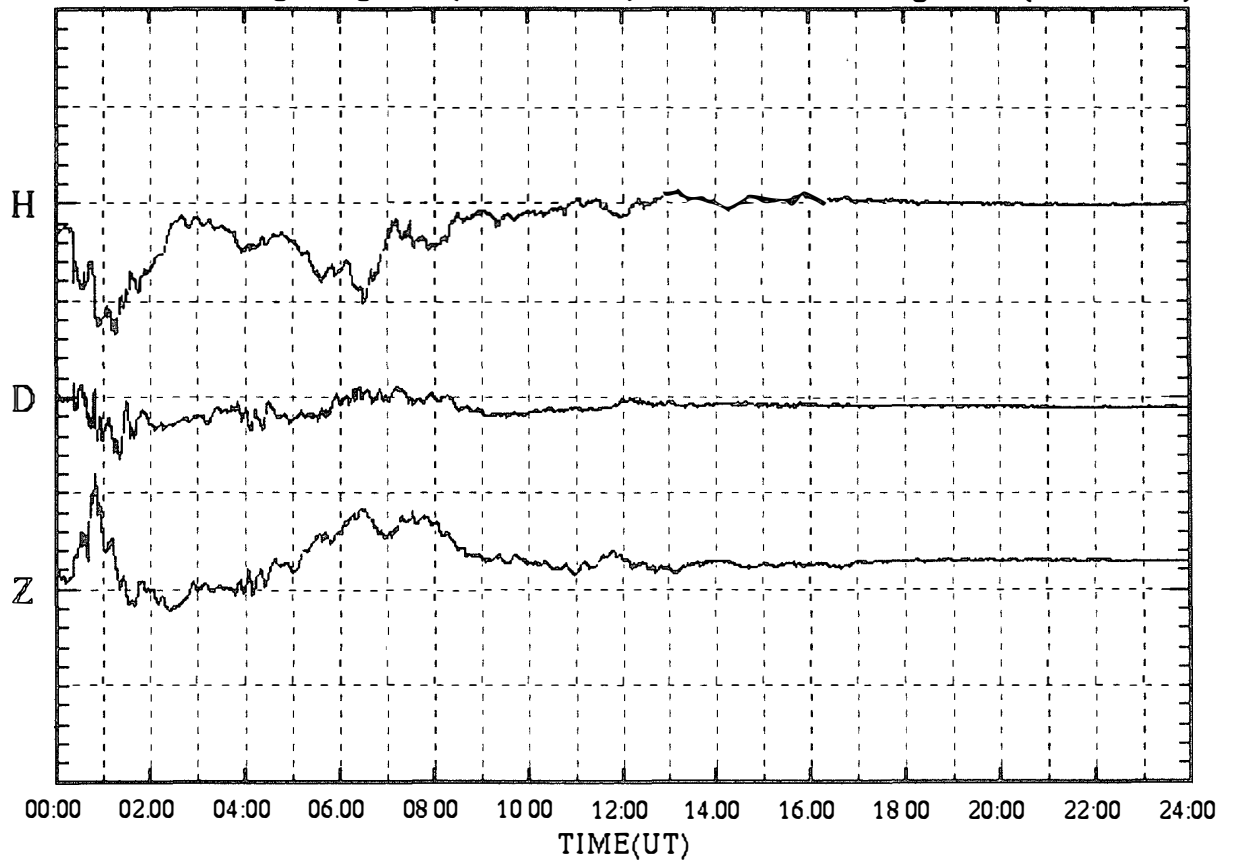

SYOWA magnetogram (100 nT/div)

10 Aug.1999 (DAY:222)

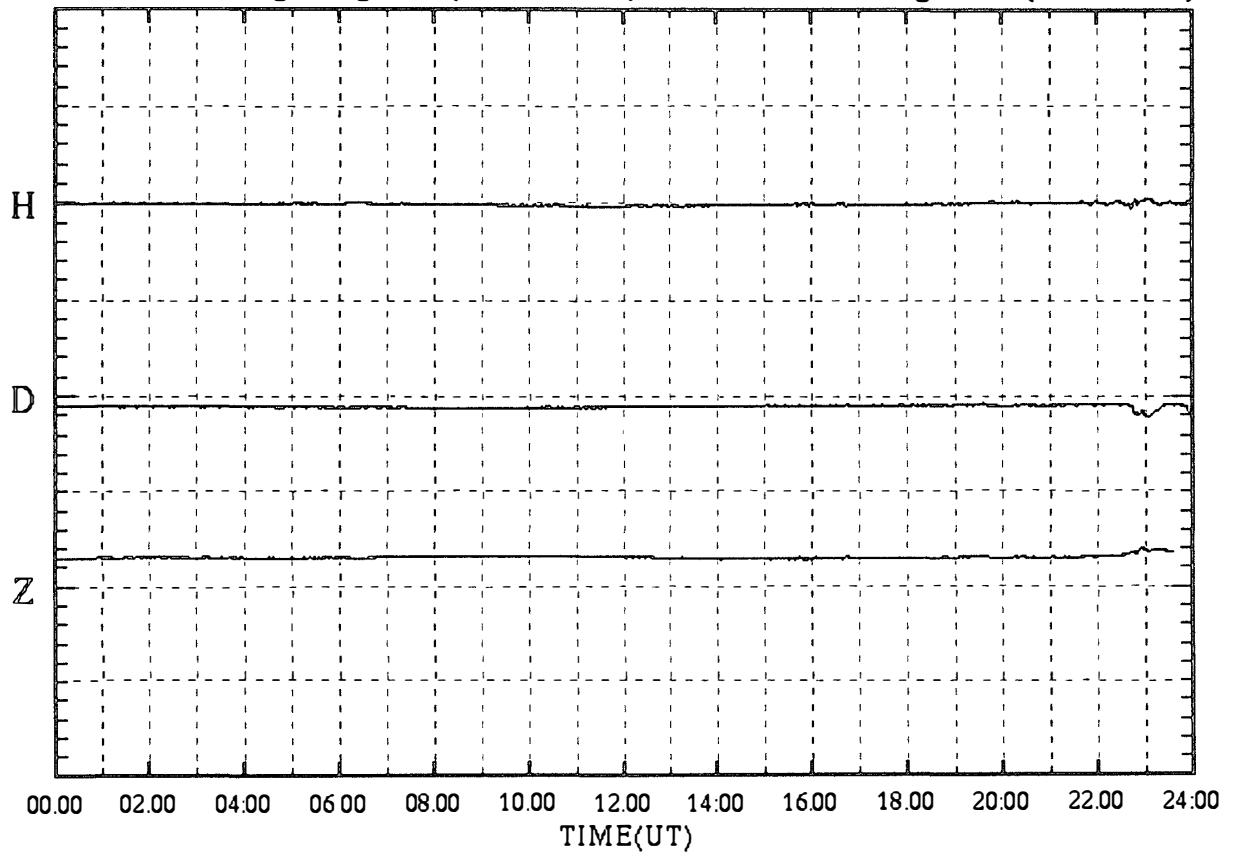

SYOWA magnetogram (100 nT/div)

11 Aug.1999 (DAY:223)

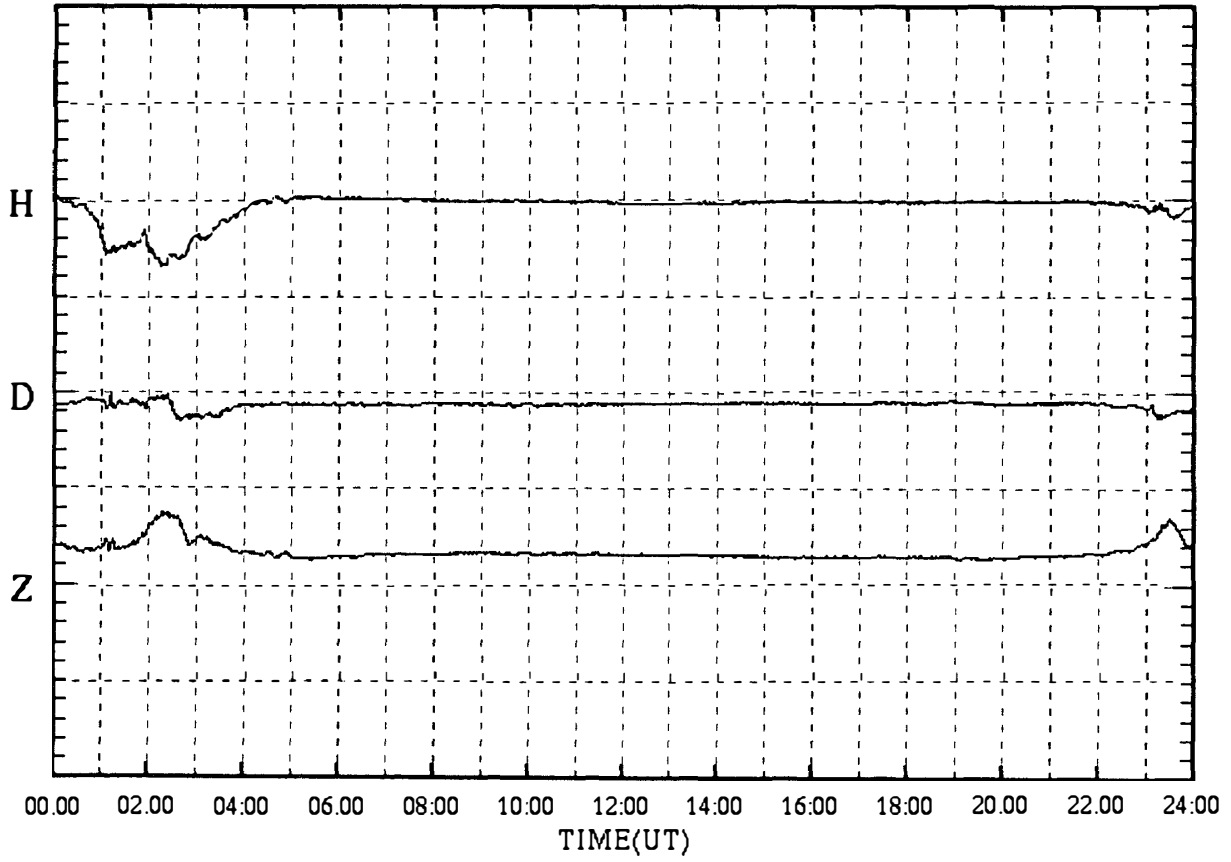

SYOWA magnetogram (100 nT/div)

12 Aug.1999 (DAY:224)

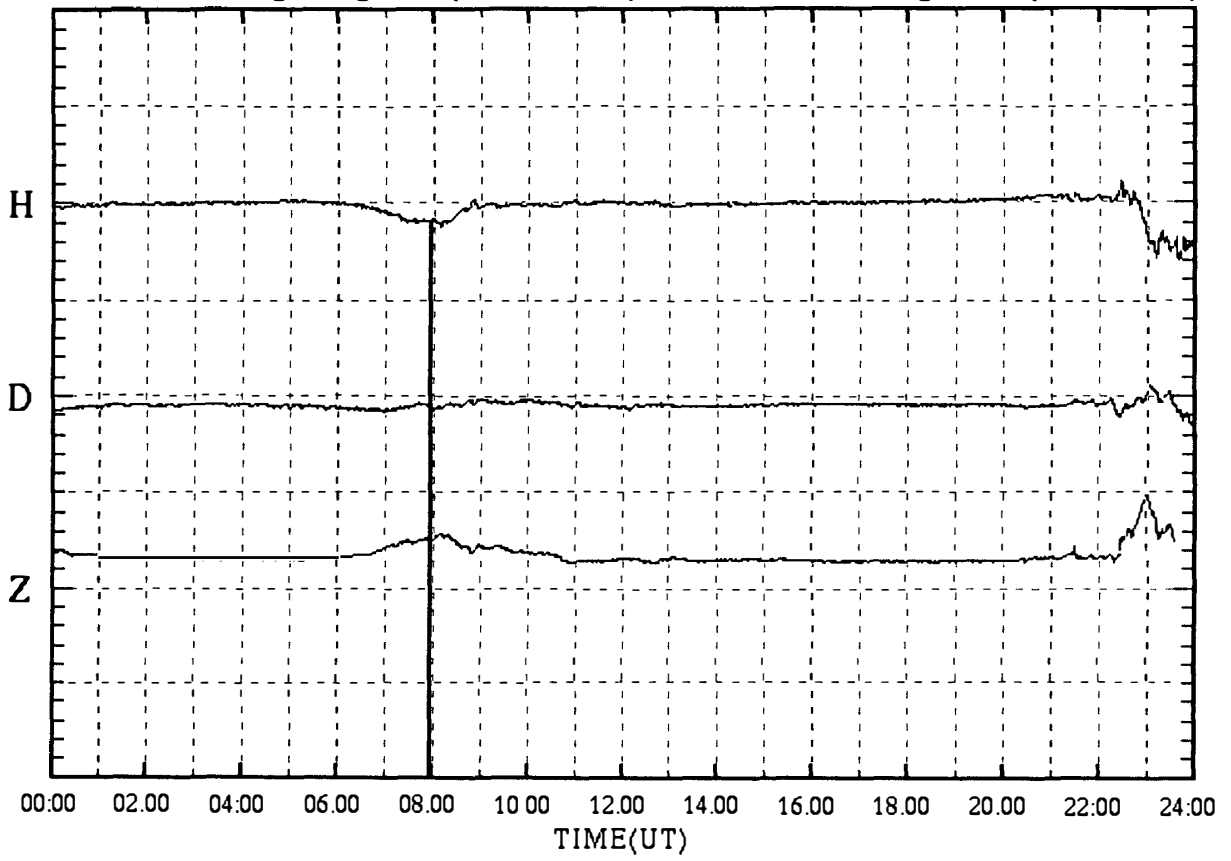



SYOWA magnetogram (100 nT/div)

13 Aug.1999 (DAY:225)

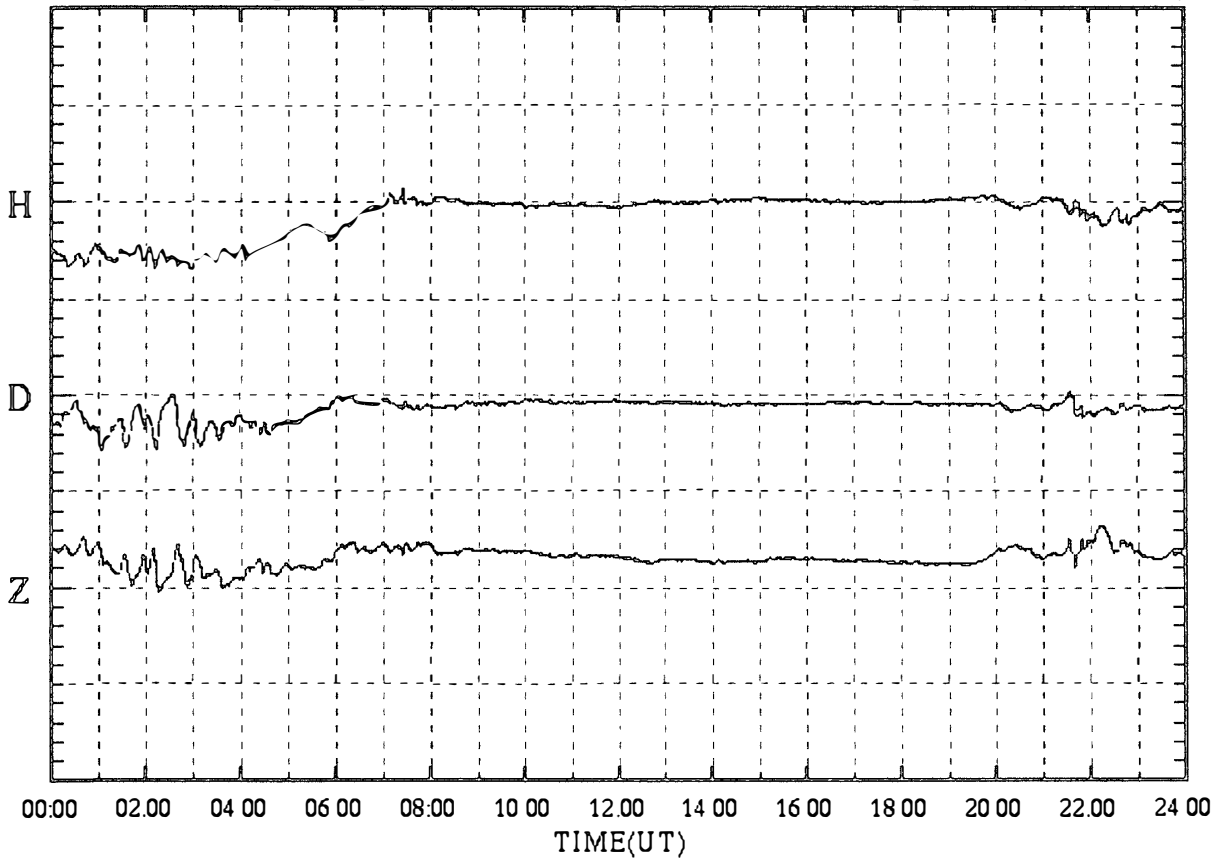

SYOWA magnetogram (100 nT/div)

14 Aug.1999 (DAY:226)

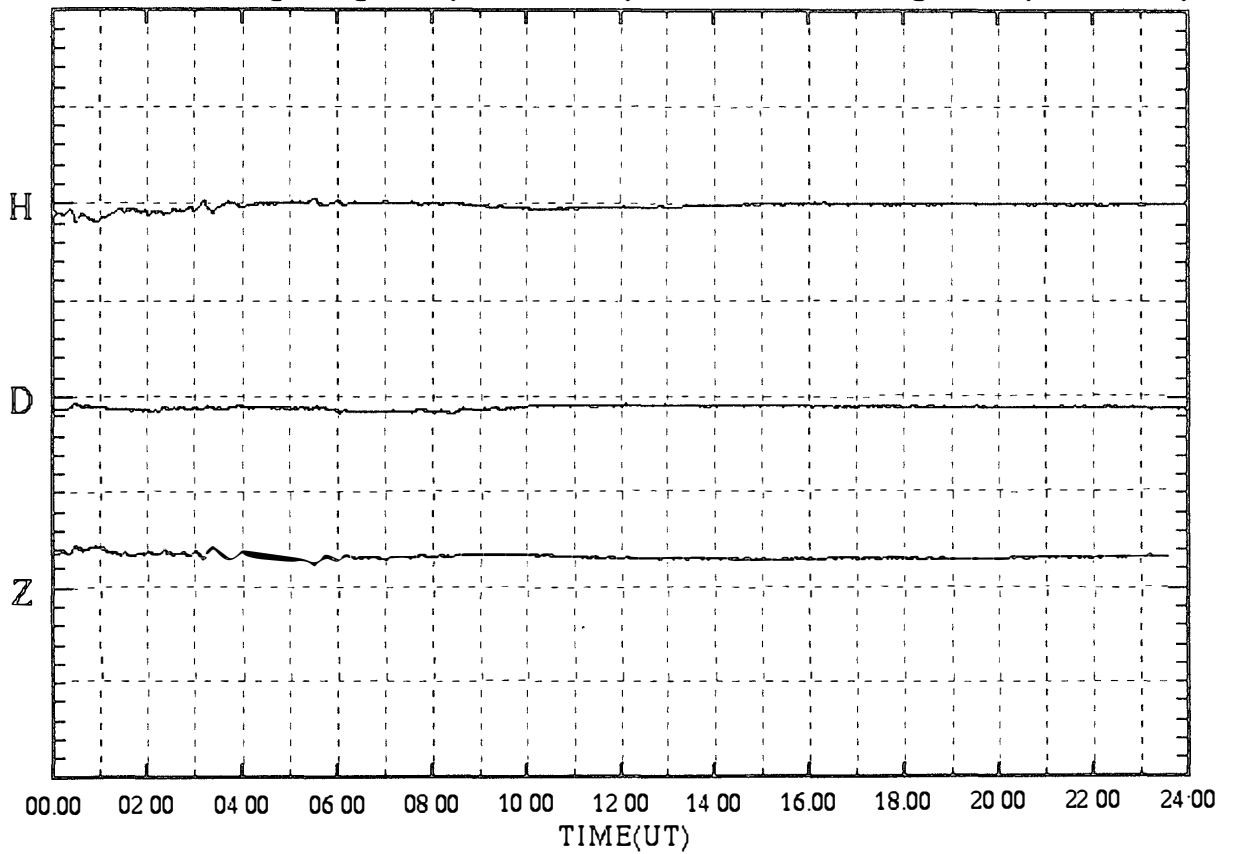

SYOWA magnetogram (100 nT/div)

15 Aug. 1999 (DAY:227)

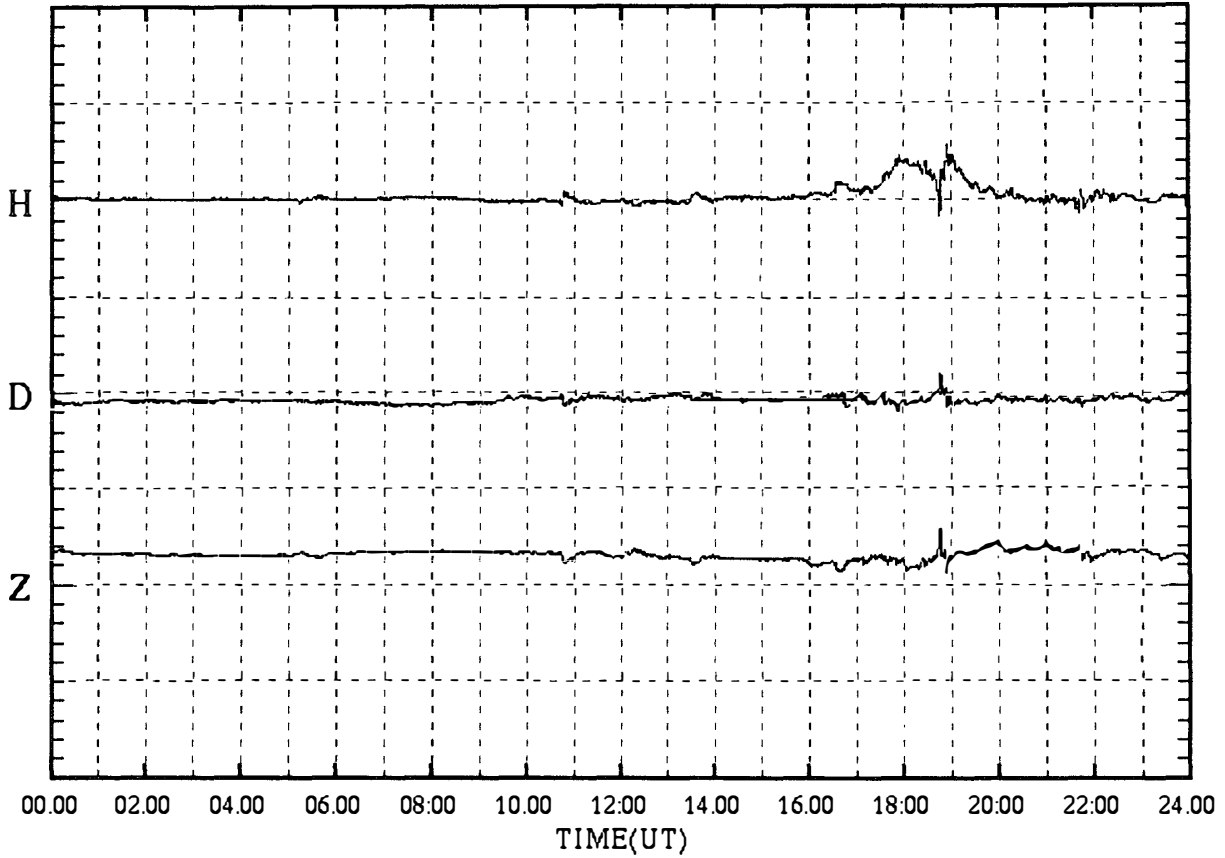

SYOWA magnetogram (100 nT/div)

16 Aug. 1999 (DAY:228)

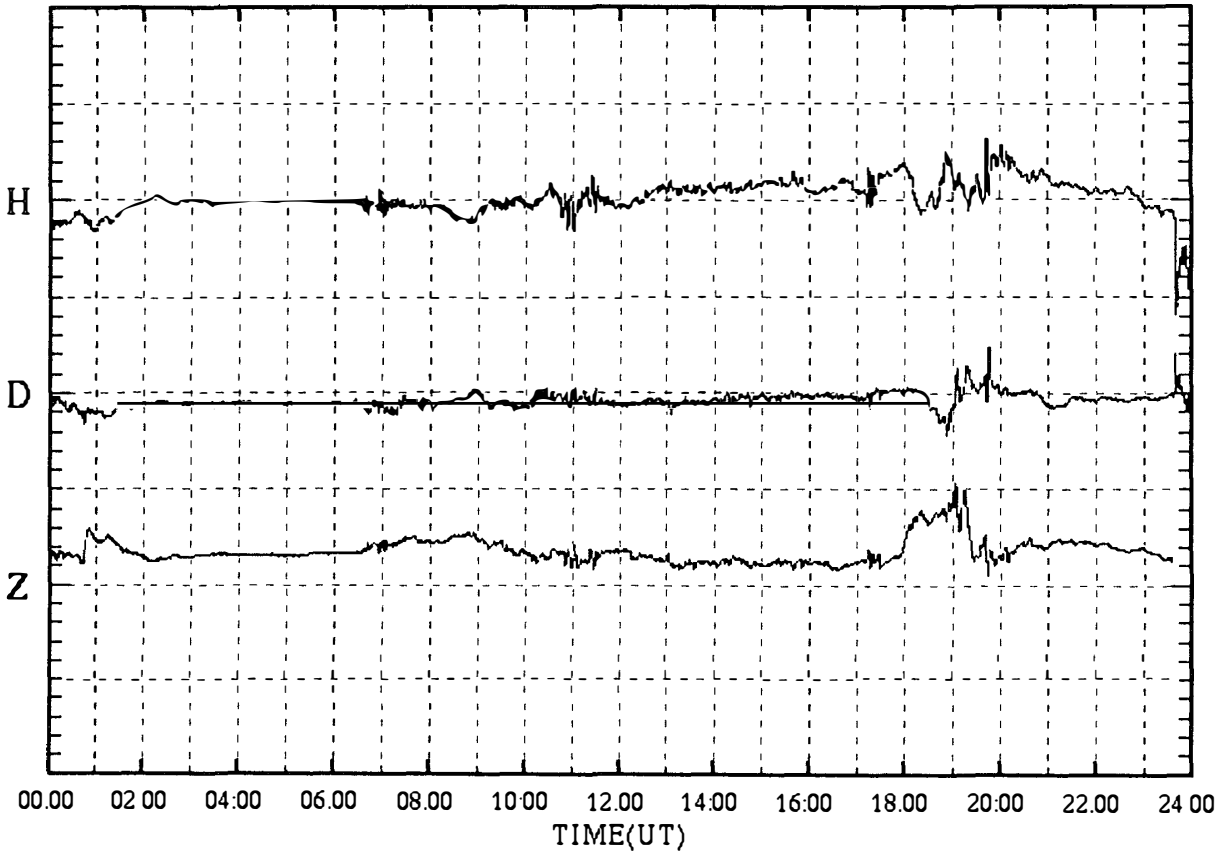

SYOWA magnetogram (100 nT/div)

17 Aug.1999 (DAY:229)

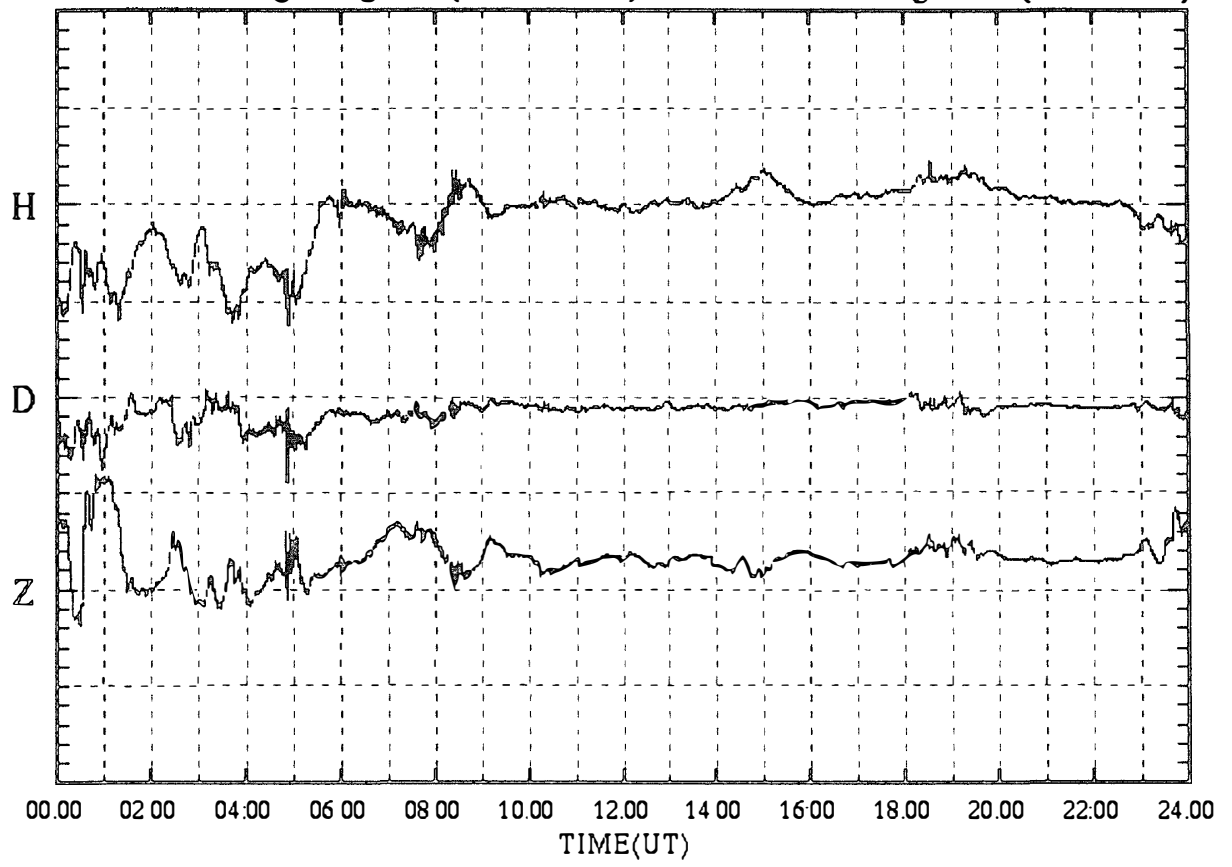

SYOWA magnetogram (100 nT/div)

18 Aug.1999 (DAY:230)

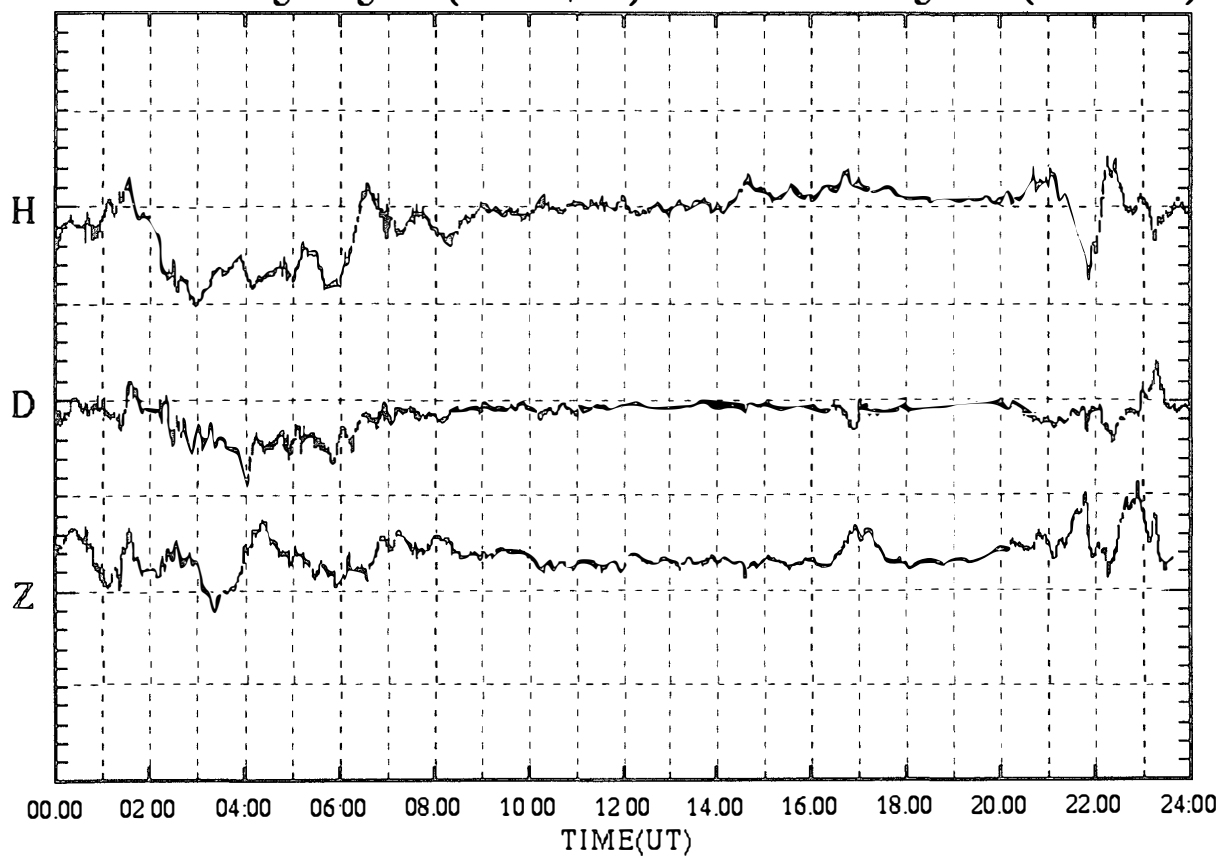

SYOWA magnetogram (100 nT/div)

19 Aug.1999 (DAY:231)

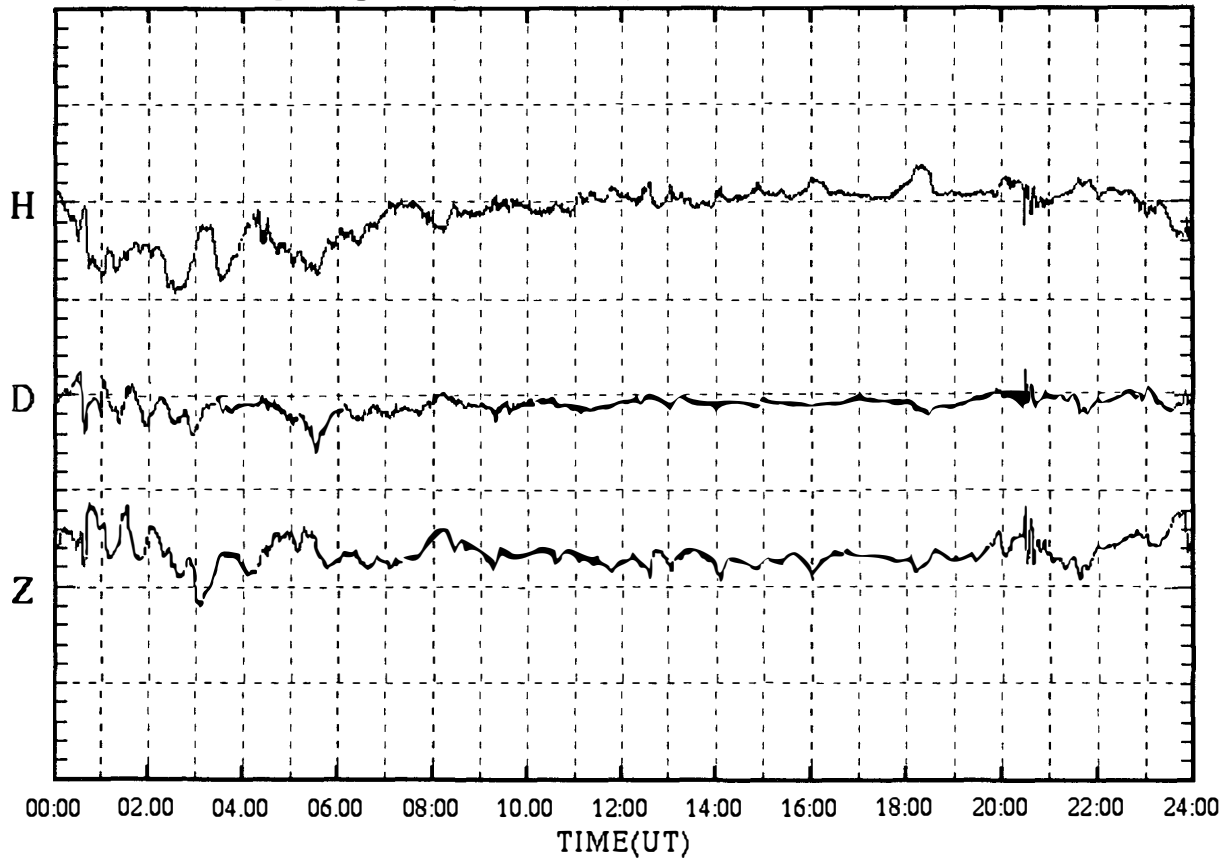

SYOWA magnetogram (100 nT/div)

20 Aug.1999 (DAY:232)

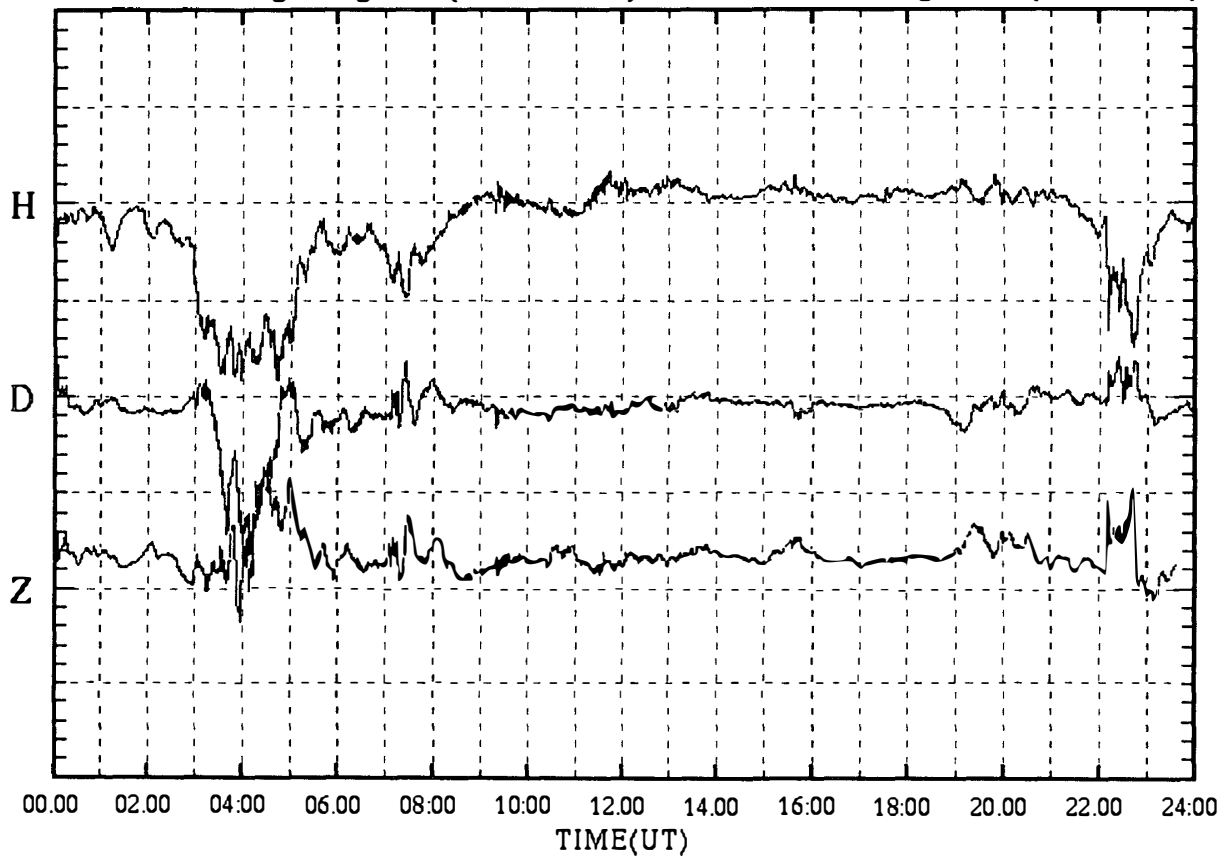

SYOWA magnetogram (100 nT/div)

21 Aug.1999 (DAY:233)

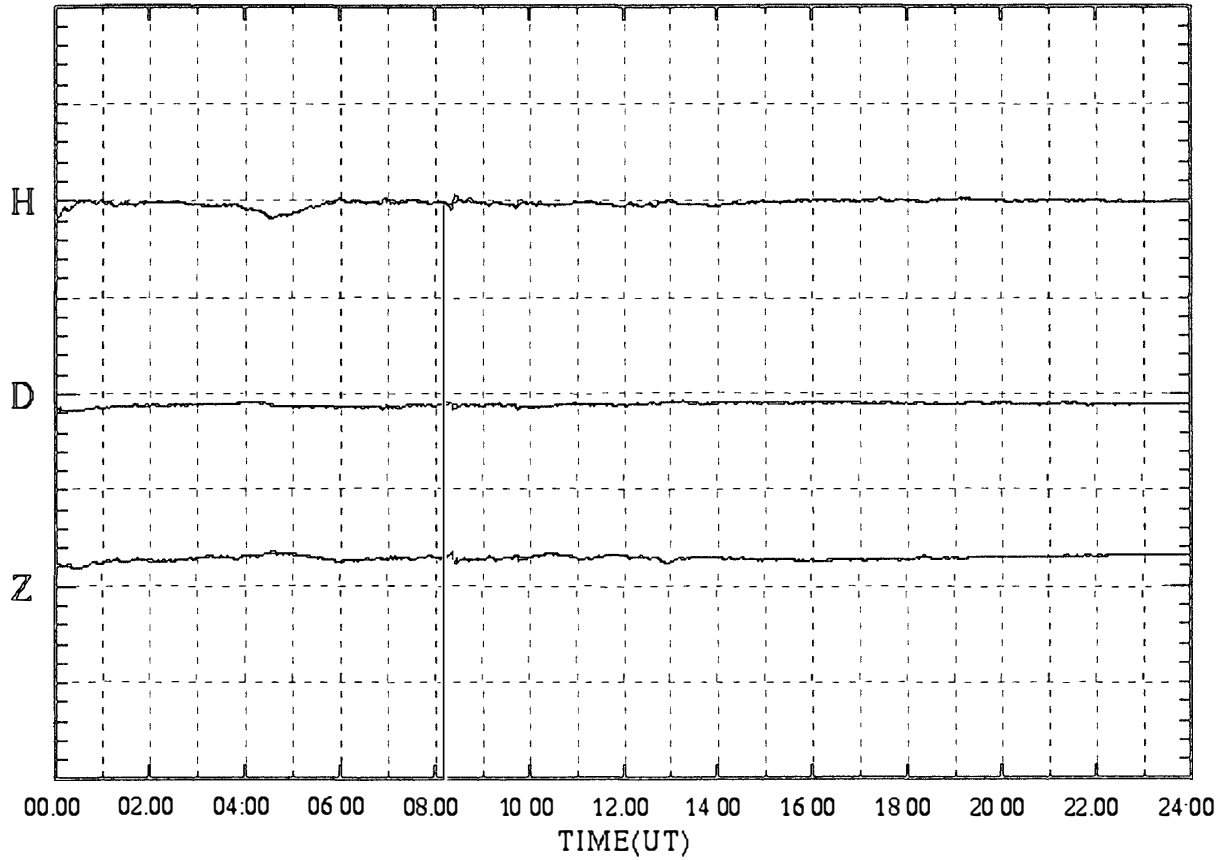

SYOWA magnetogram (100 nT/div)

22 Aug.1999 (DAY:234)

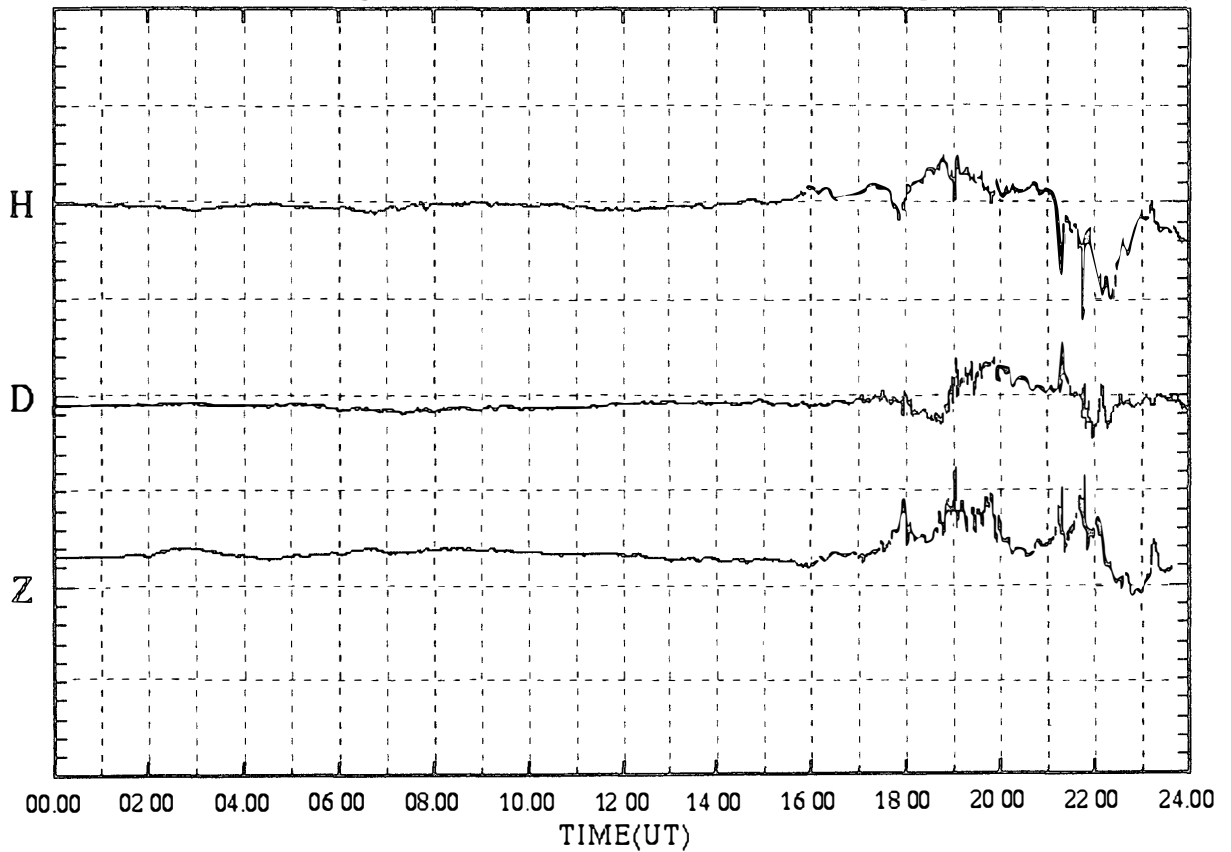

SYOWA magnetogram (100 nT/div)

23 Aug.1999 (DAY:235)

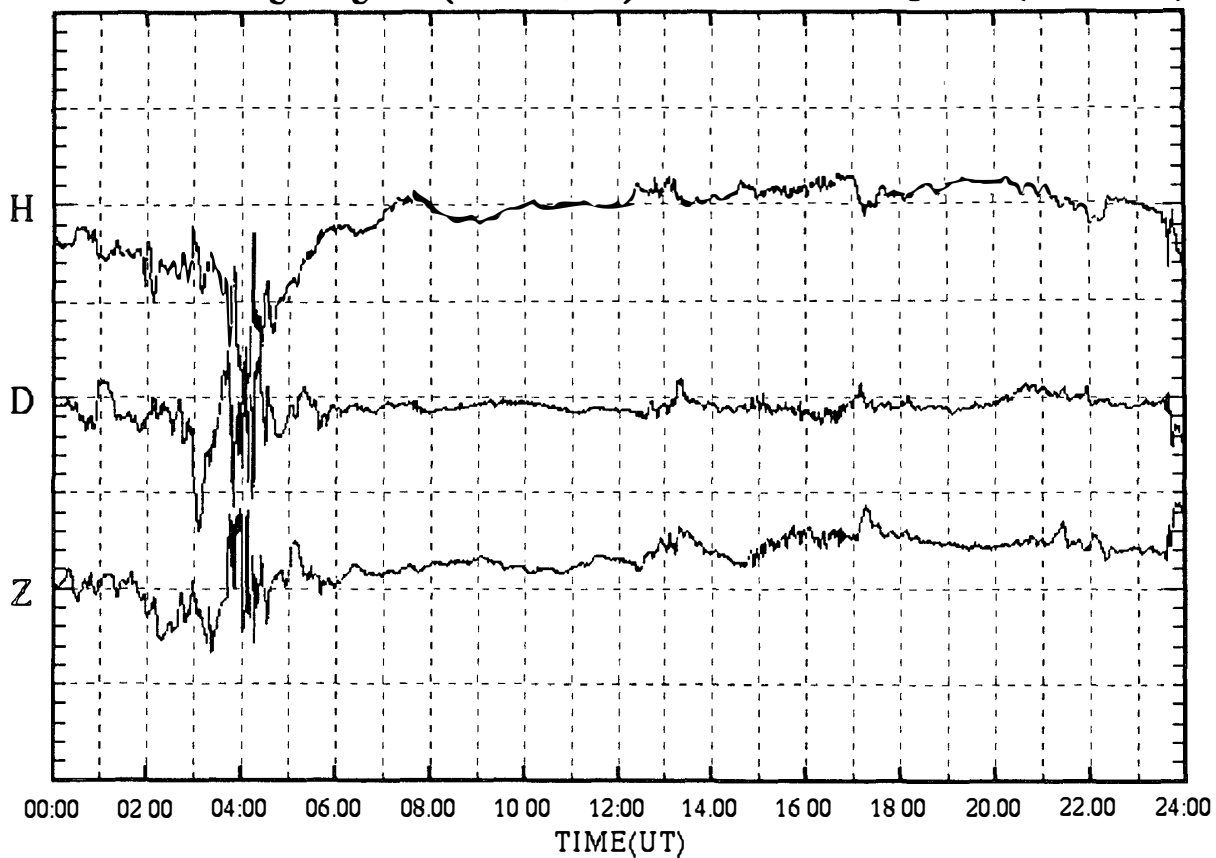

SYOWA magnetogram (100 nT/div)

24 Aug.1999 (DAY:236)

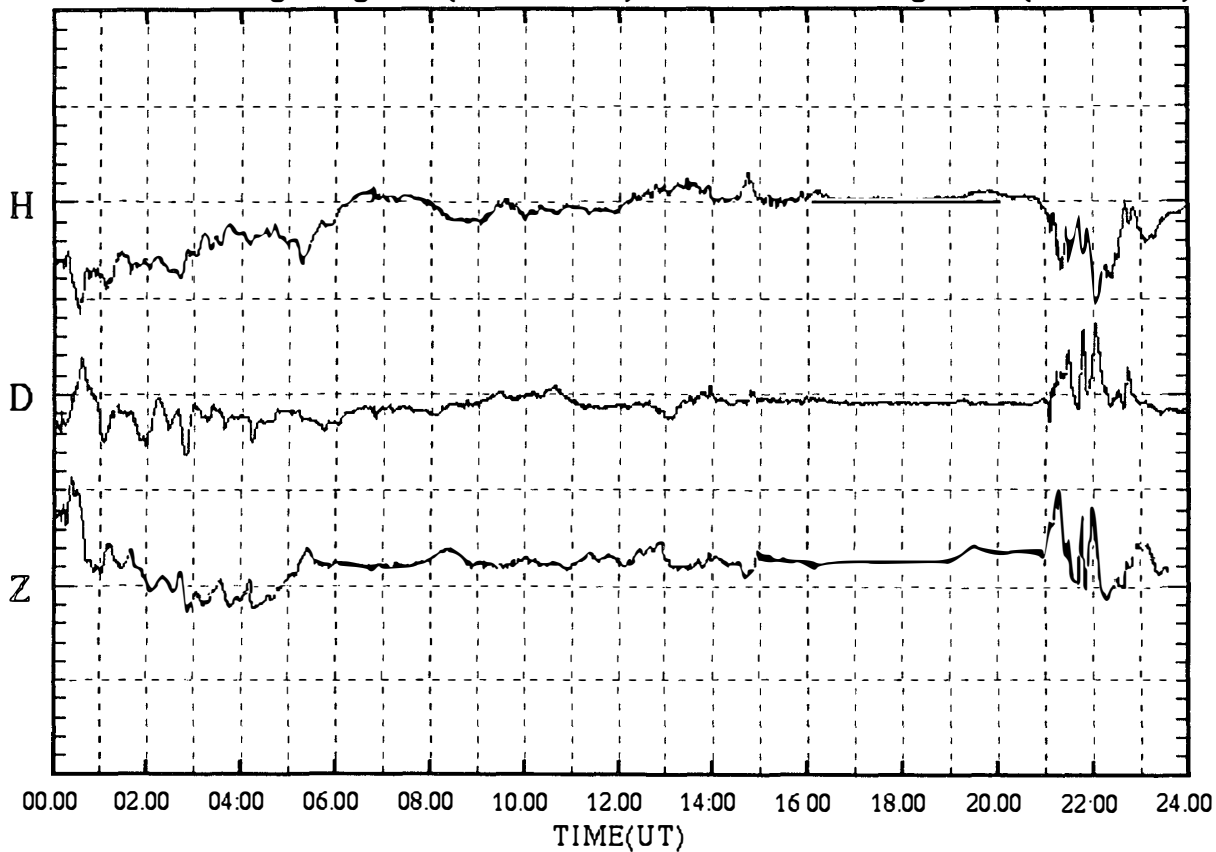

SYOWA magnetogram (100 nT/div)

25 Aug.1999 (DAY:237)

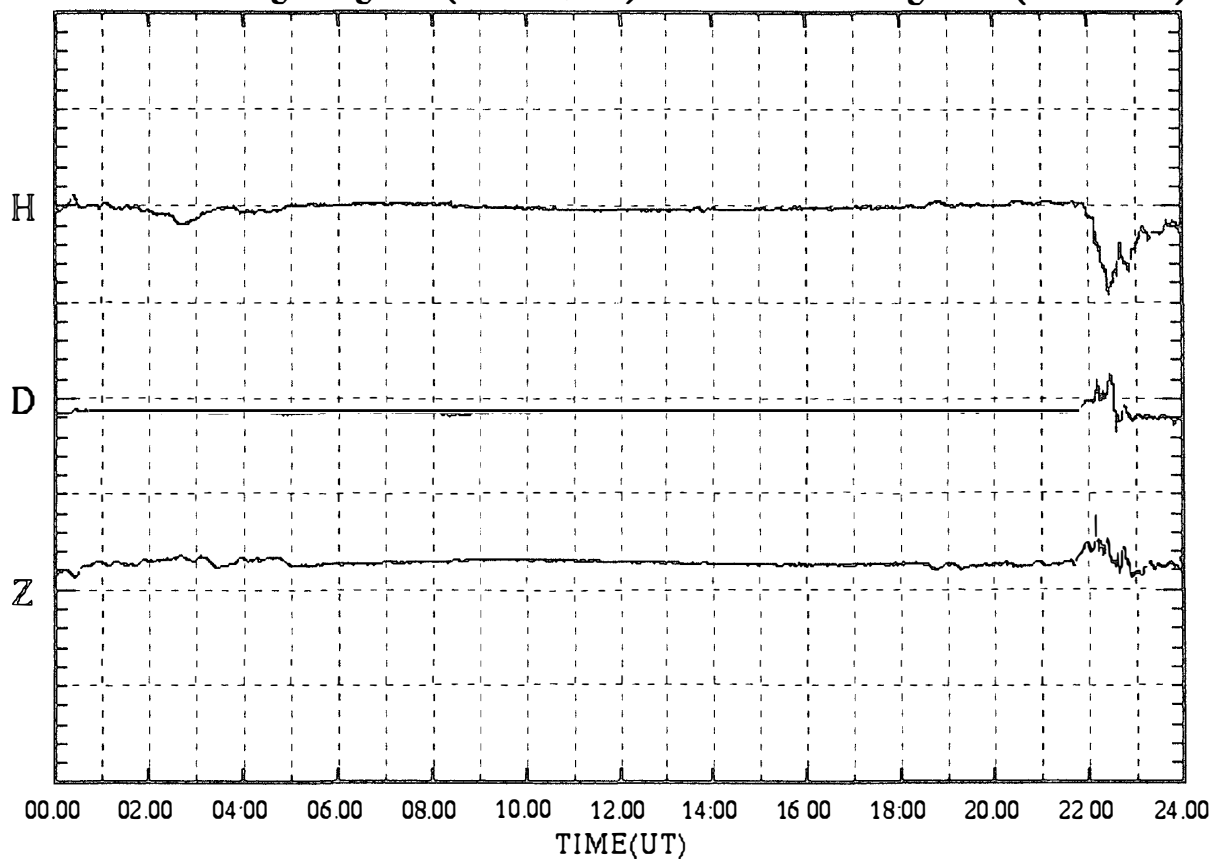

SYOWA magnetogram (100 nT/div)

26 Aug.1999 (DAY:238)

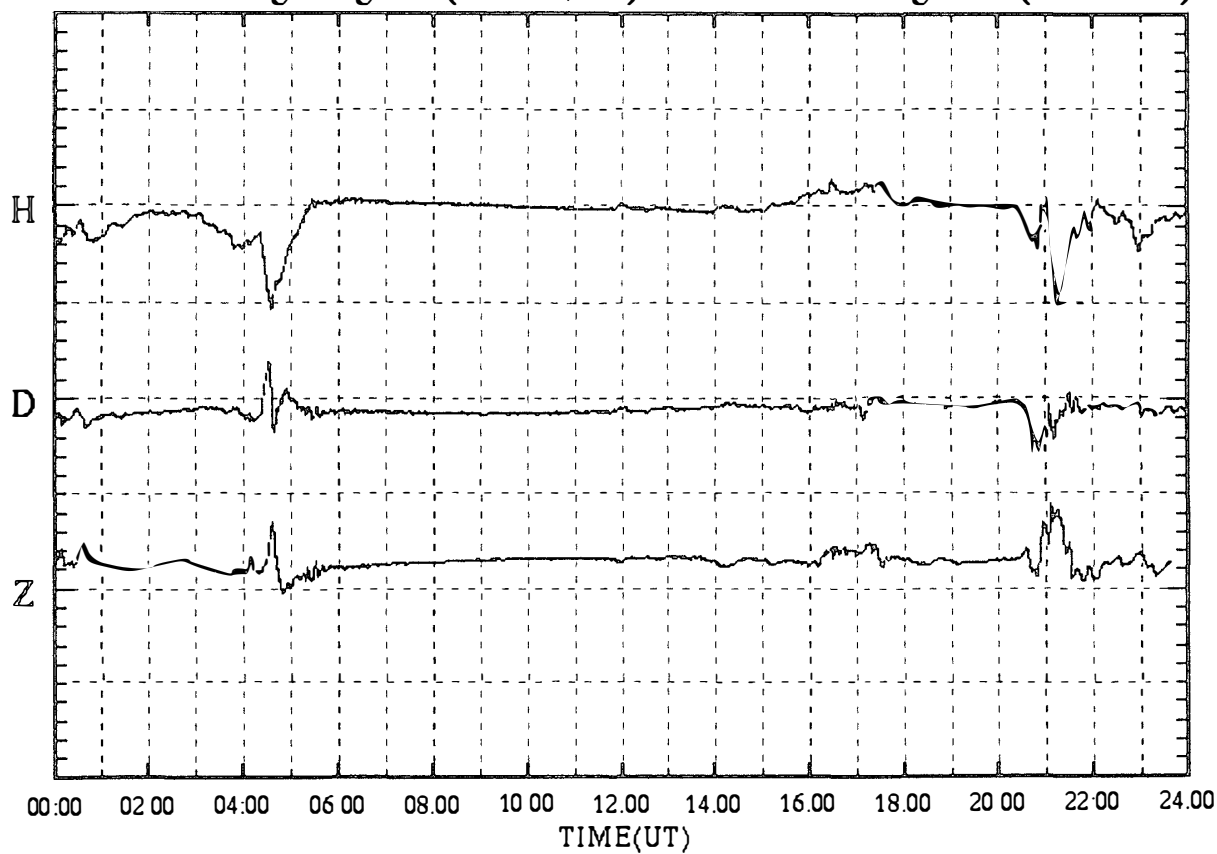

SYOWA magnetogram (100 nT/div)

27 Aug.1999 (DAY:239)

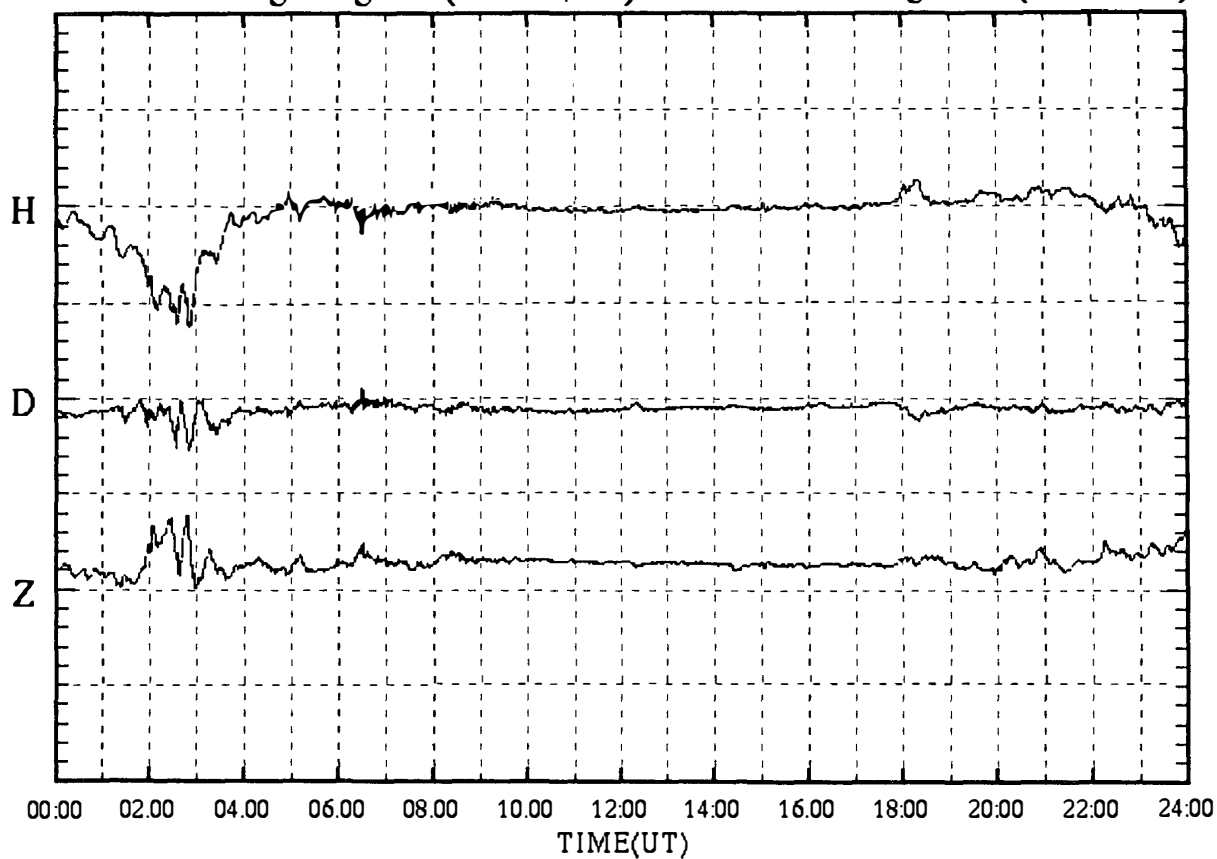

SYOWA magnetogram (100 nT/div)

28 Aug.1999 (DAY:240)

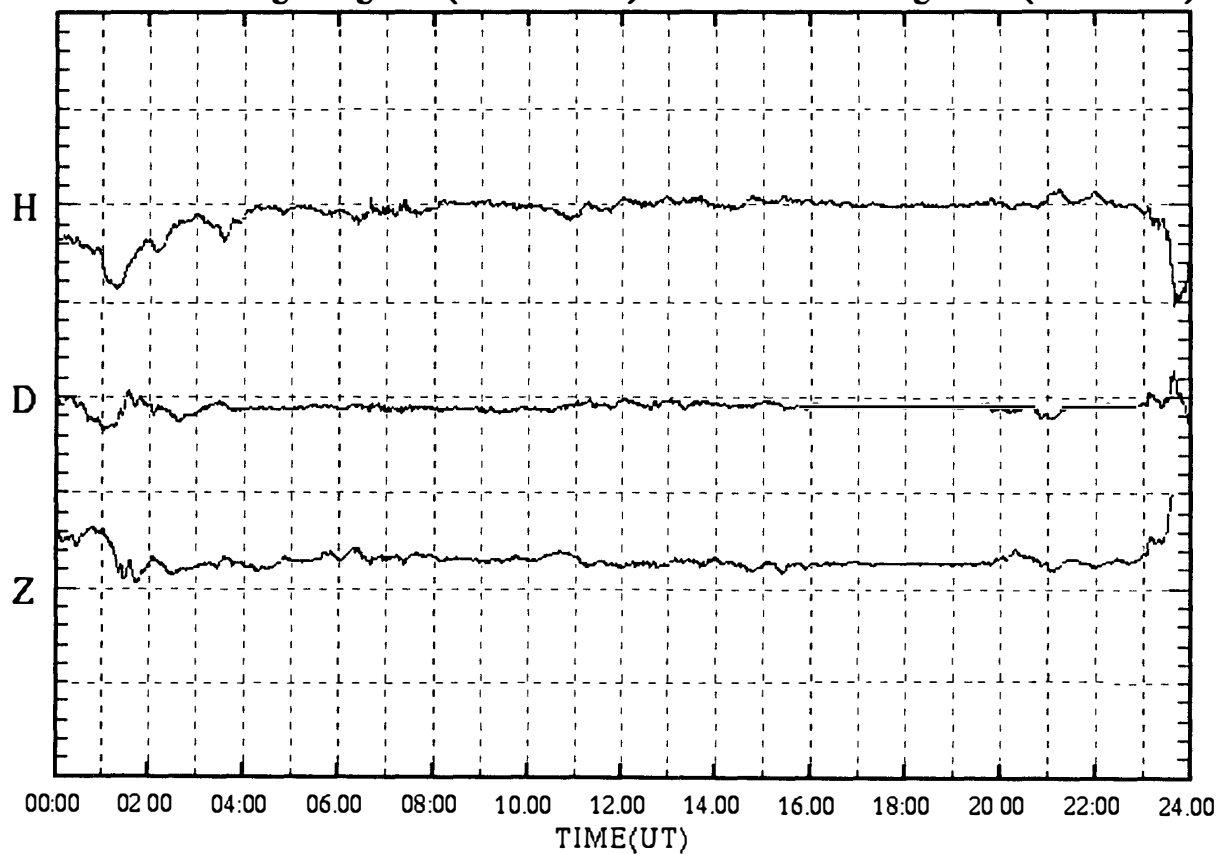



SYOWA magnetogram (100 nT/div)

29 Aug.1999 (DAY:241)

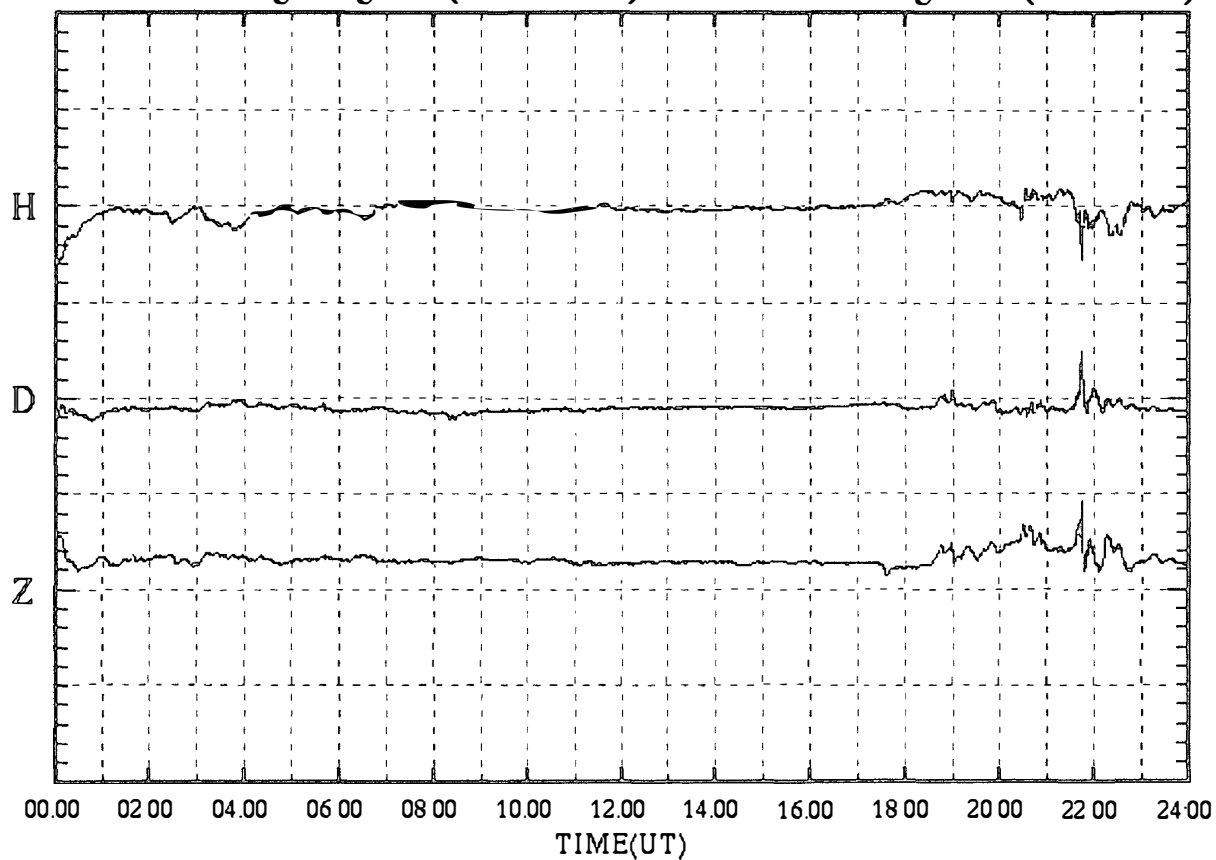

SYOWA magnetogram (100 nT/div)

30 Aug.1999 (DAY:242)

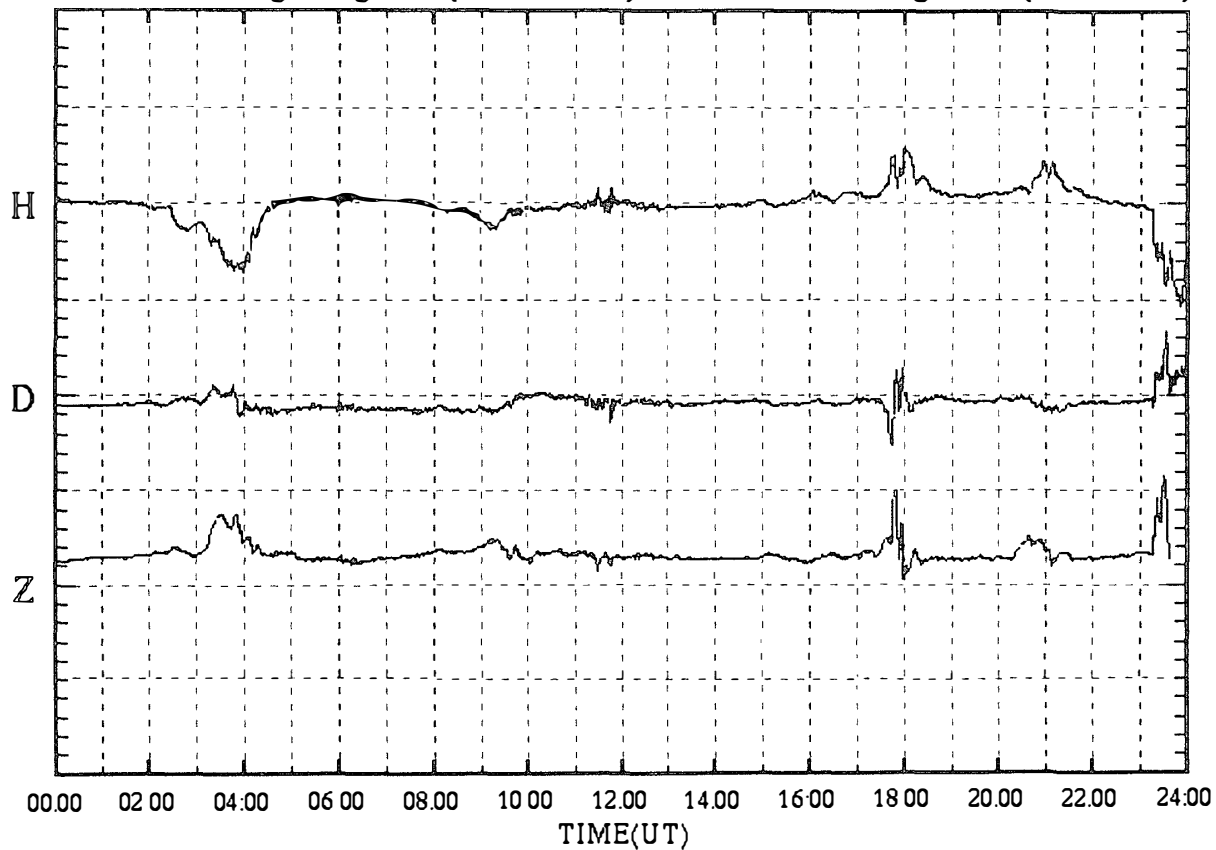

SYOWA magnetogram (100 nT/div)

31 Aug.1999 (DAY:243)

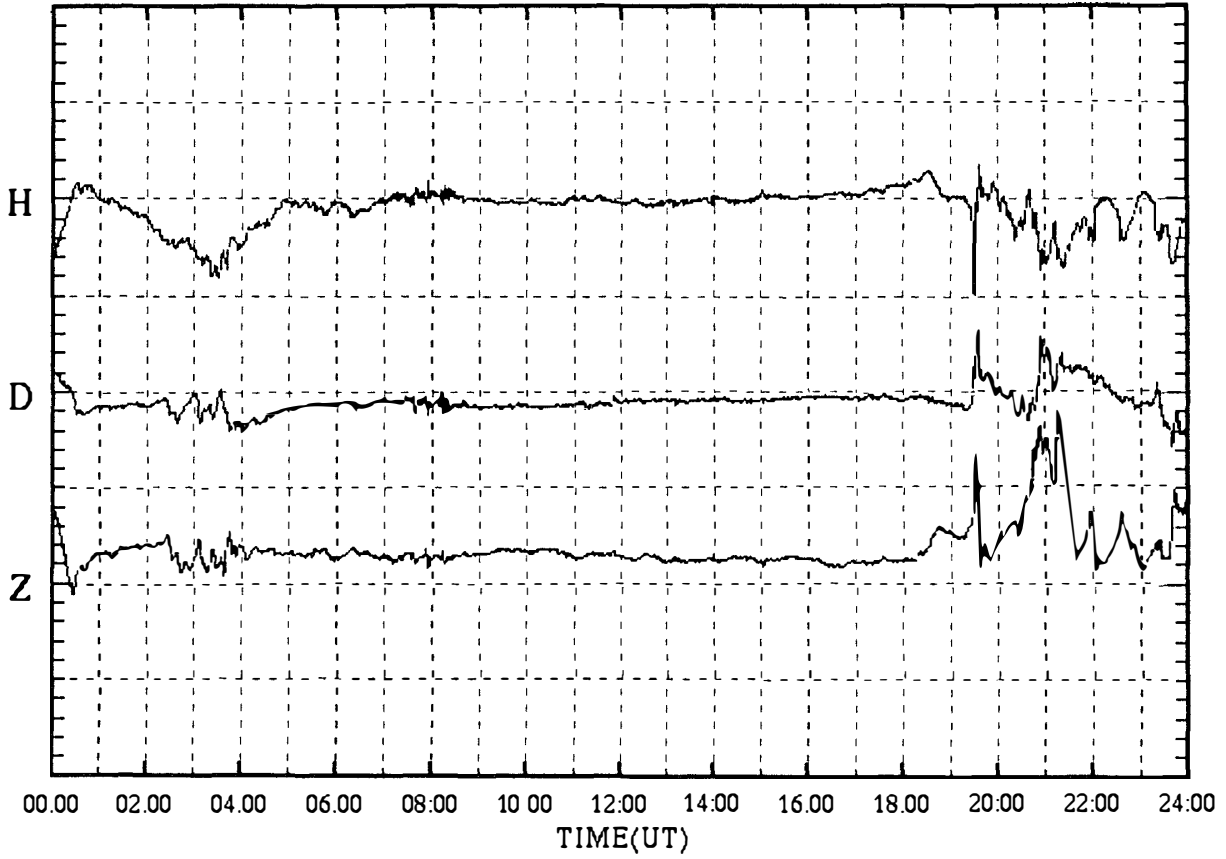

SYOWA magnetogram (100 nT/div)

01 Sep.1999 (DAY:244)

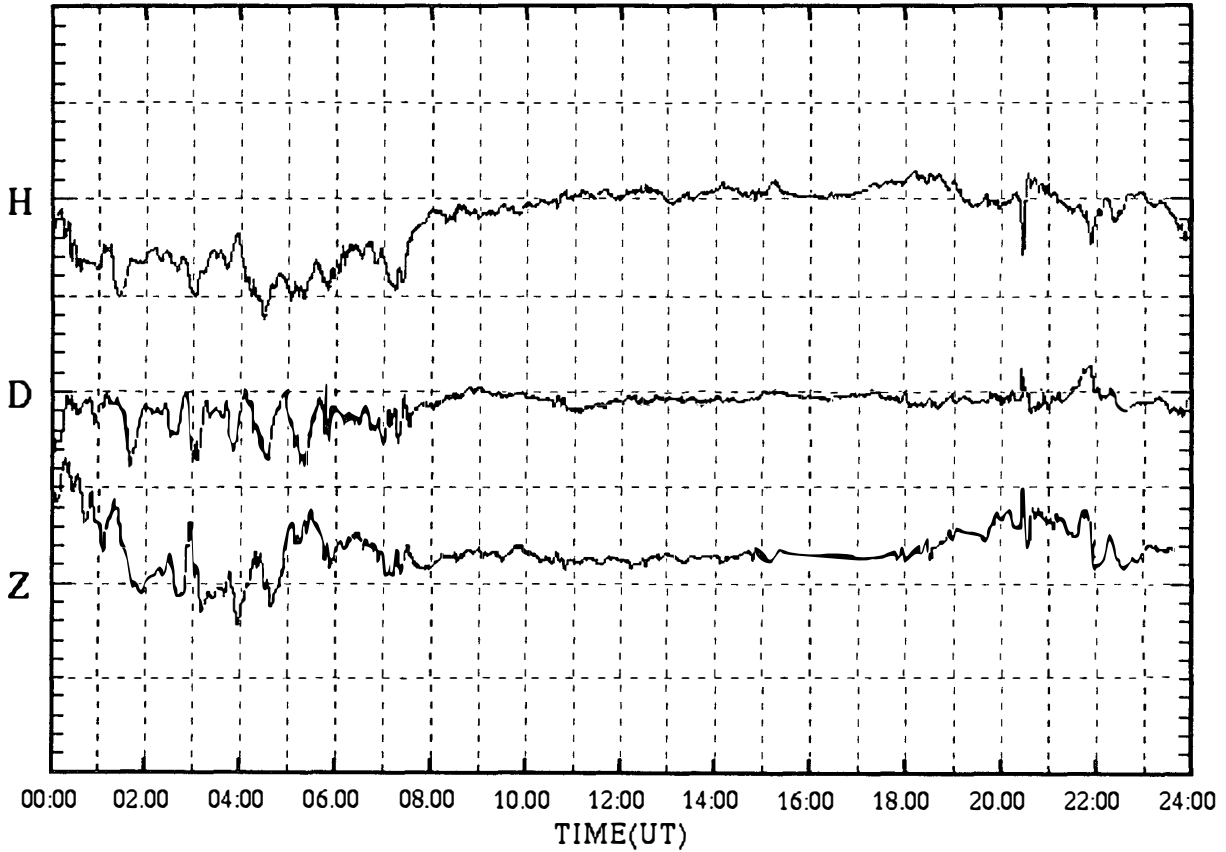

SYOWA magnetogram (100 nT/div)

02 Sep.1999 (DAY:245)

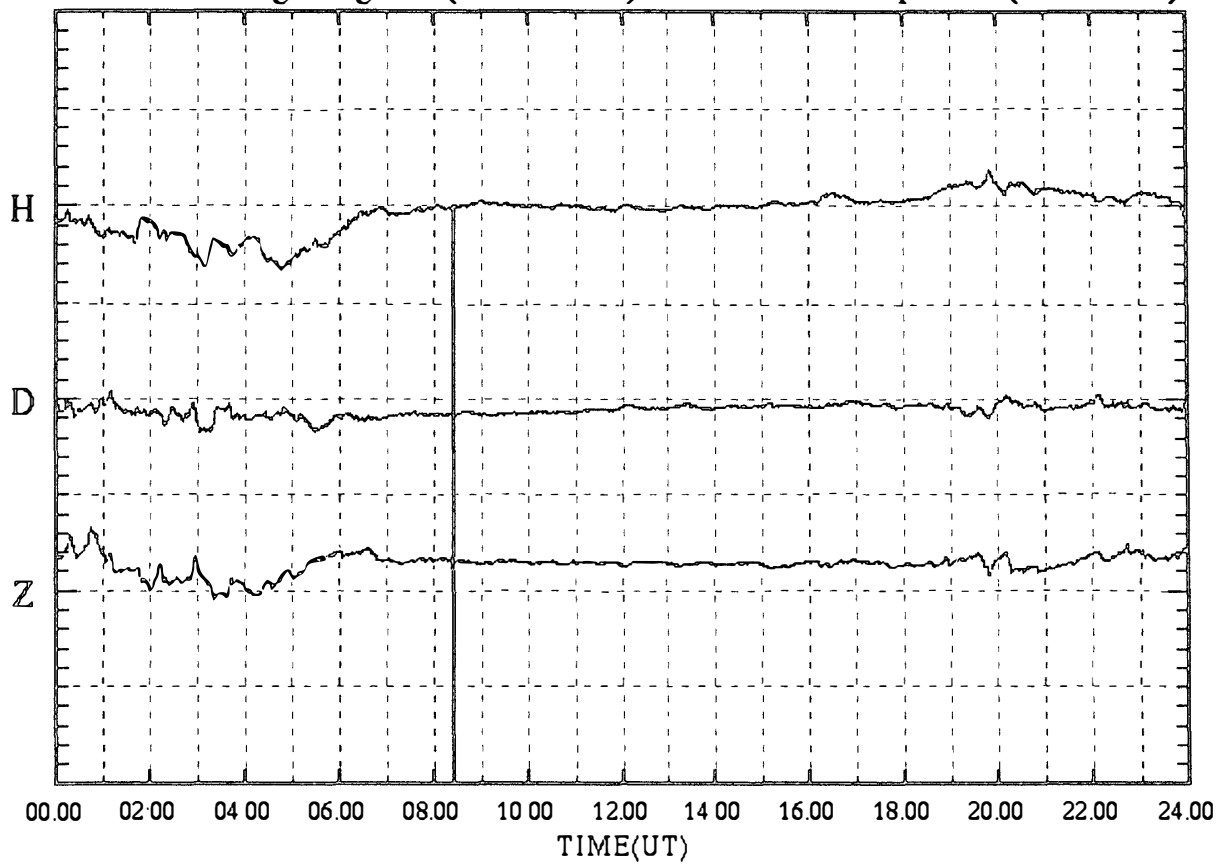

SYOWA magnetogram (100 nT/div)

03 Sep.1999 (DAY:246)

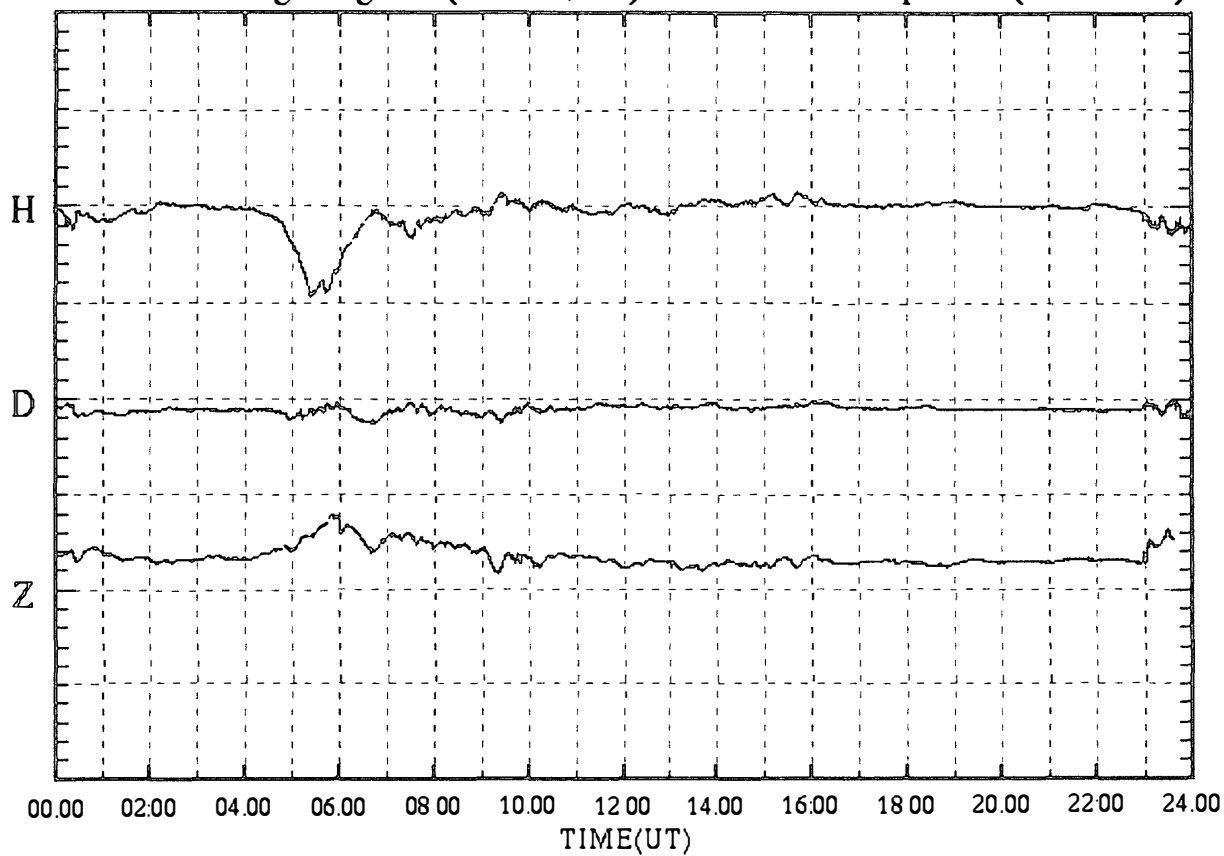

SYOWA magnetogram (100 nT/div)

04 Sep.1999 (DAY:247)

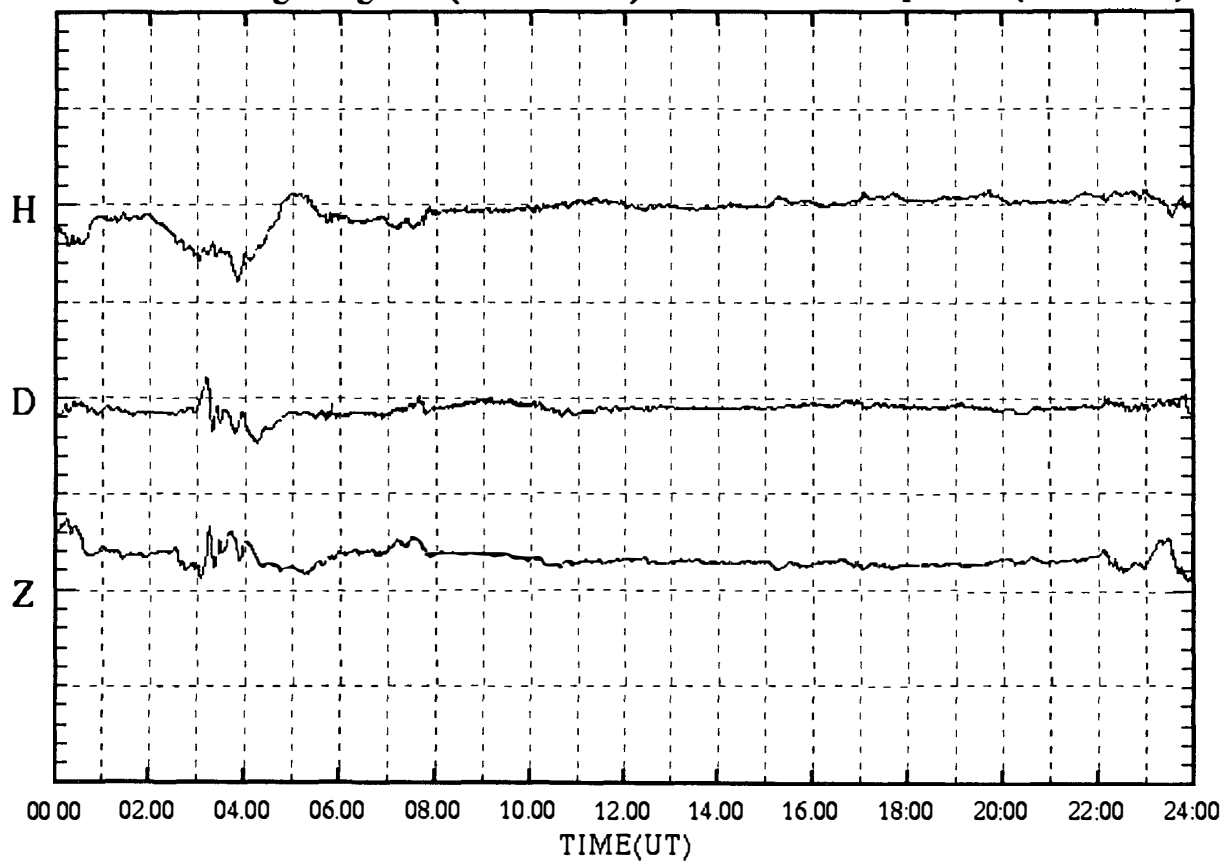

SYOWA magnetogram (100 nT/div)

05 Sep.1999 (DAY:248)

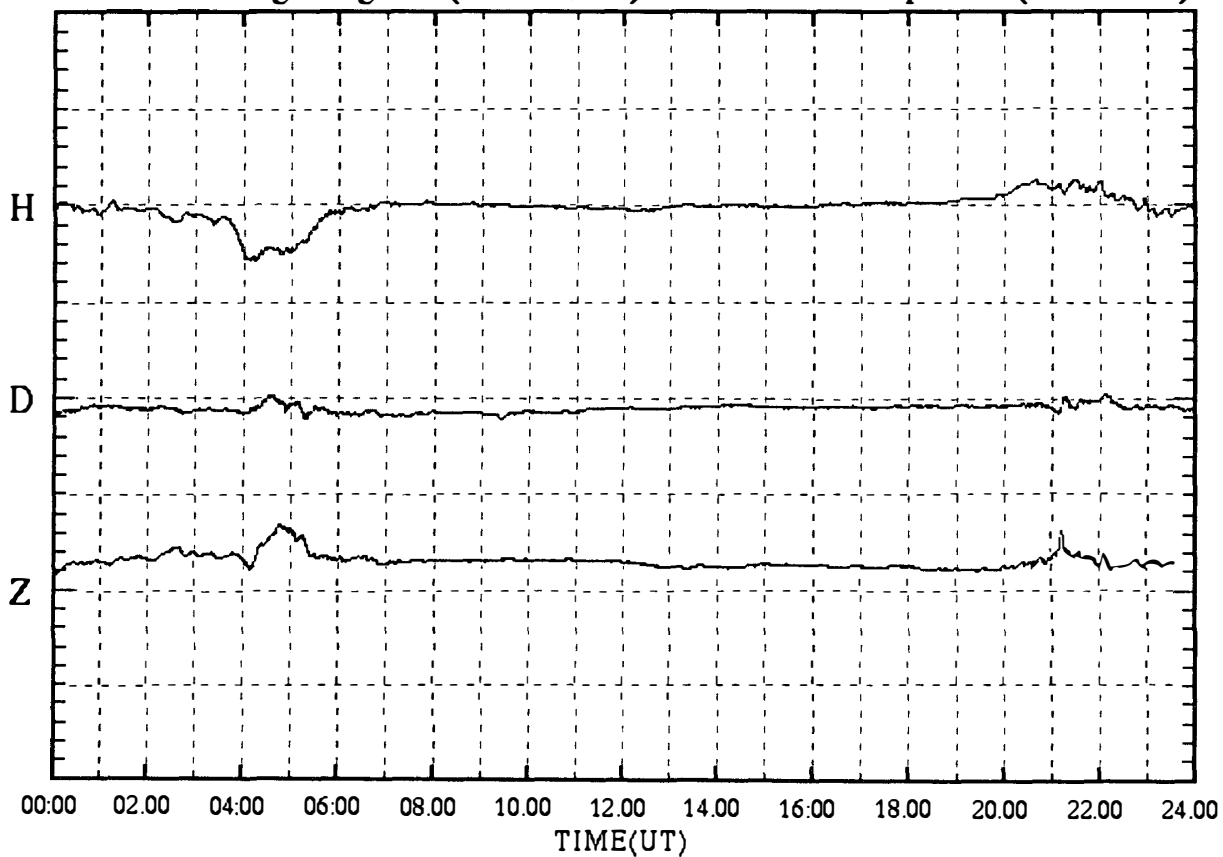

SYOWA magnetogram (100 nT/div)

06 Sep.1999 (DAY:249)

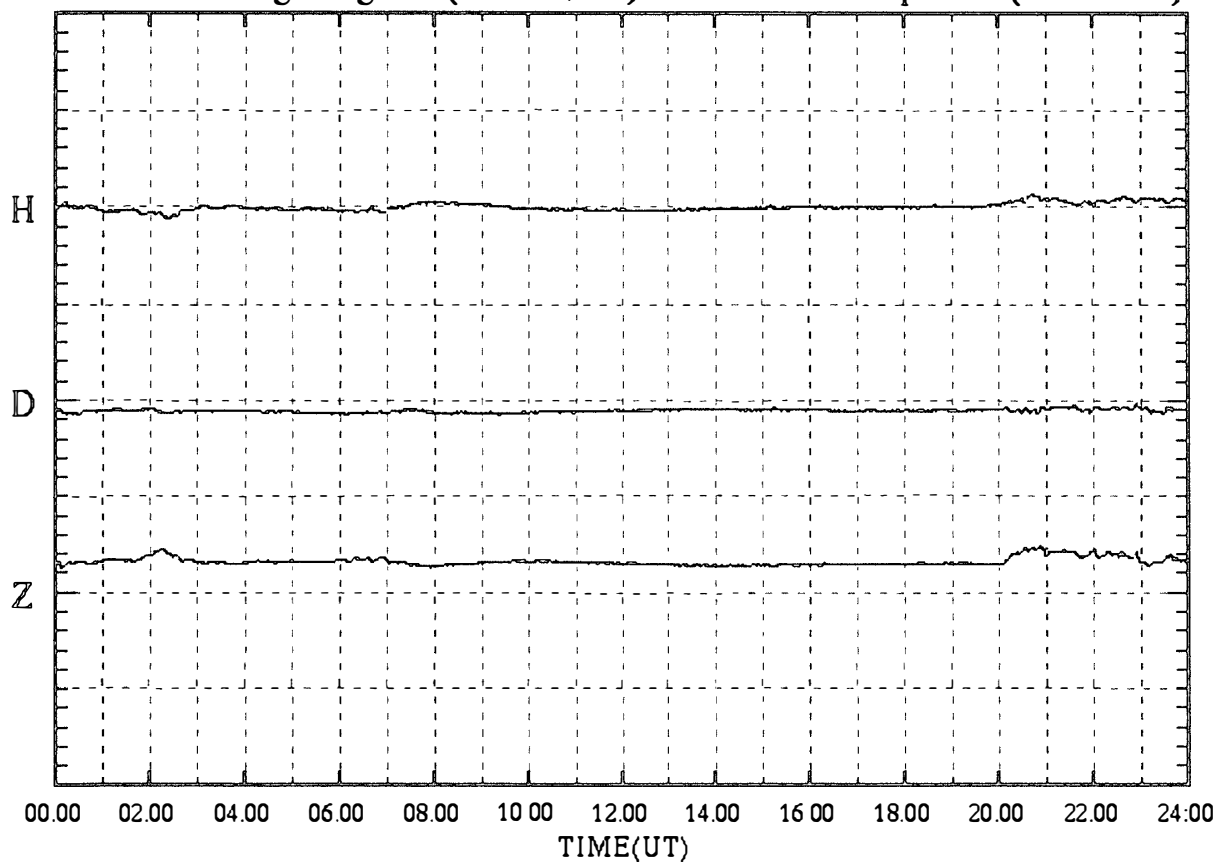

SYOWA magnetogram (100 nT/div)

07 Sep.1999 (DAY:250)

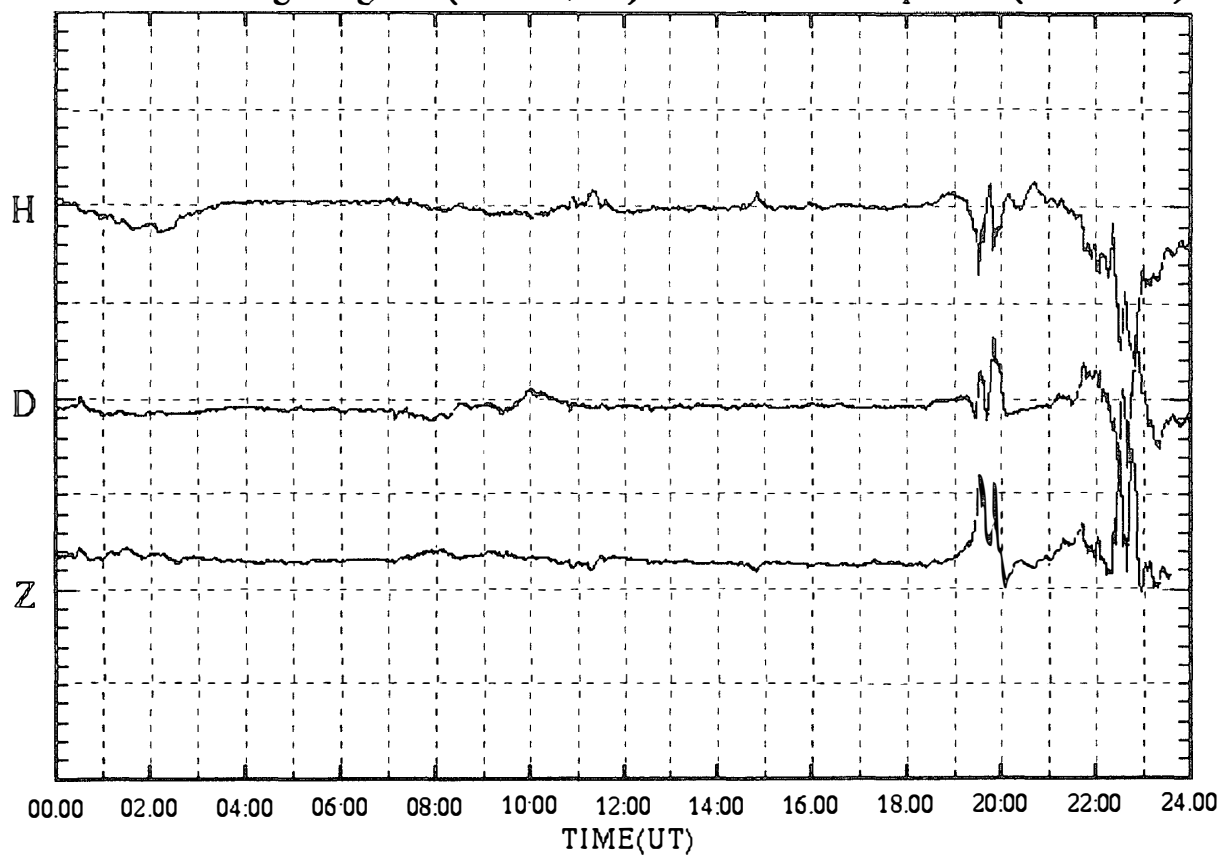

SYOWA magnetogram (100 nT/div)

08 Sep.1999 (DAY:251)

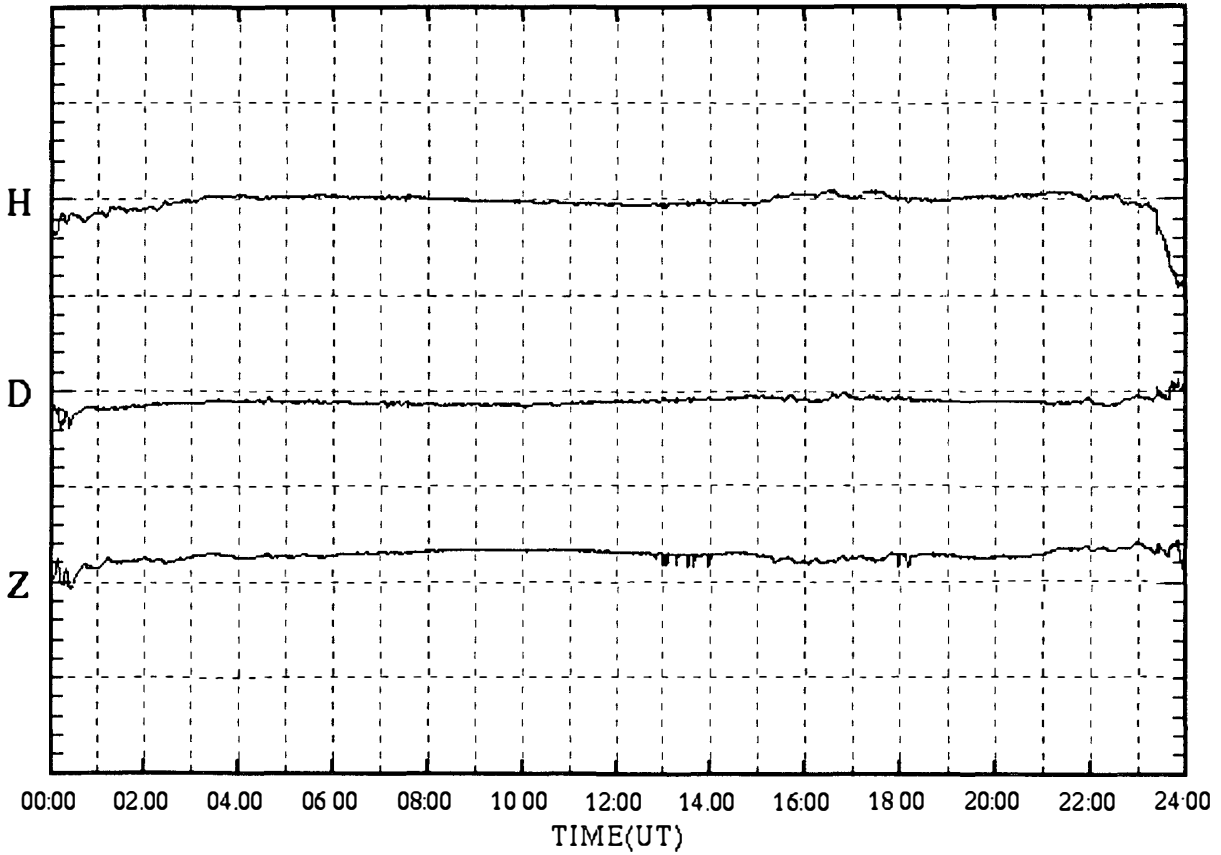

SYOWA magnetogram (100 nT/div)

09 Sep.1999 (DAY:252)

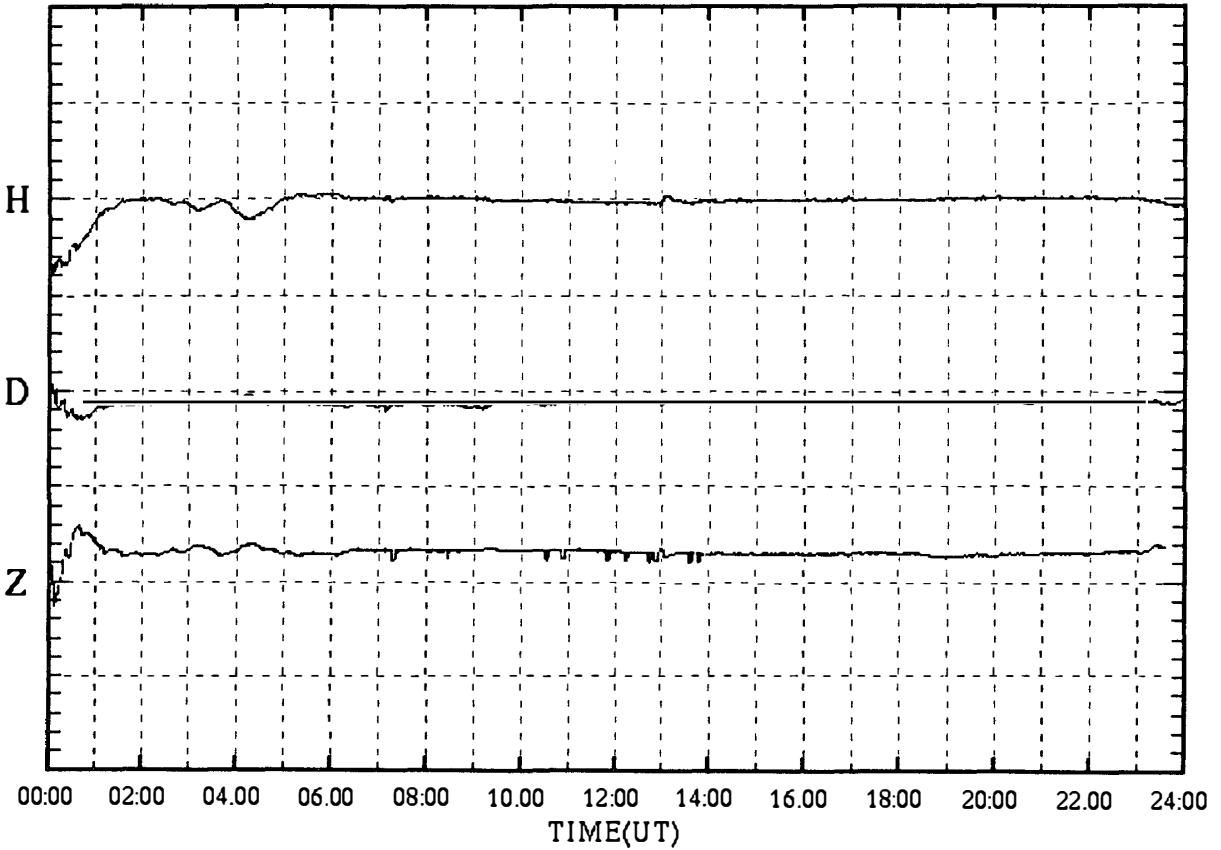

SYOWA magnetogram (100 nT/div)

10 Sep.1999 (DAY:253)

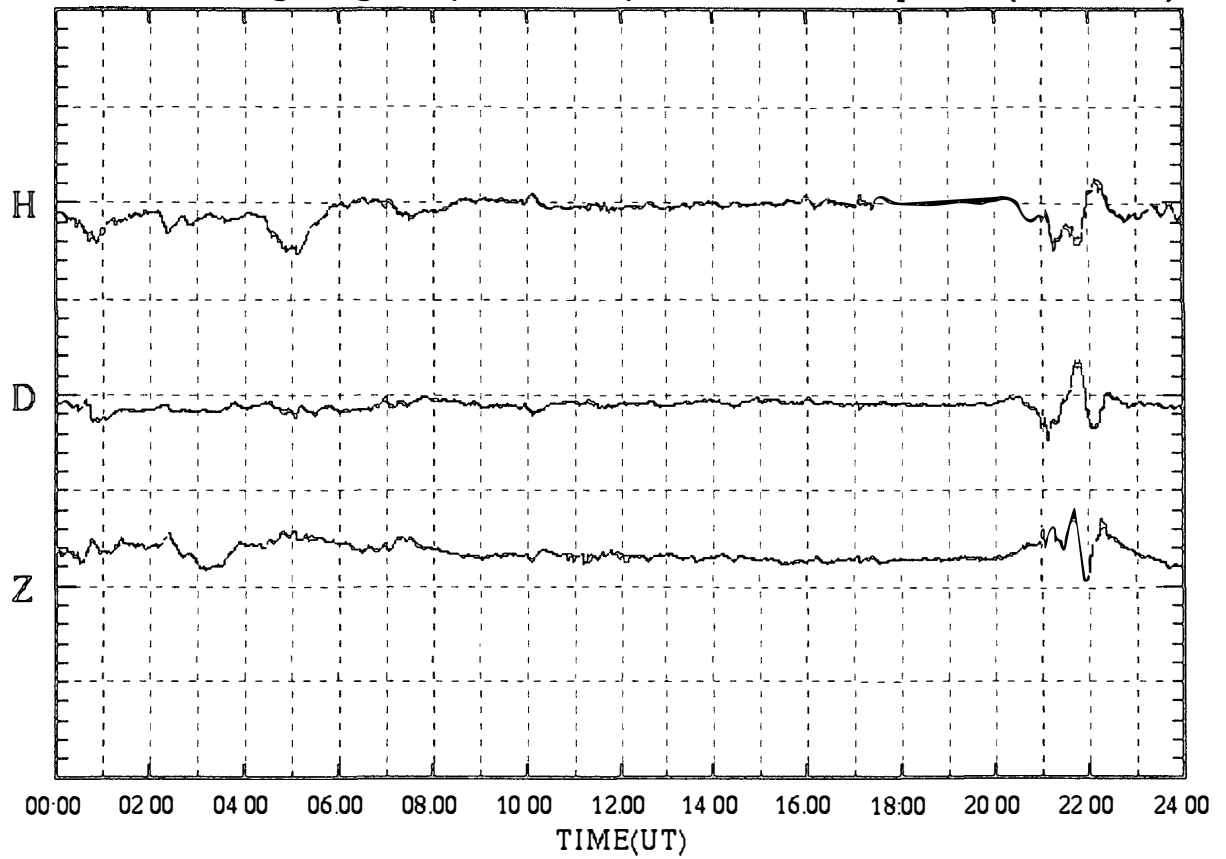

SYOWA magnetogram (100 nT/div)

11 Sep.1999 (DAY:254)

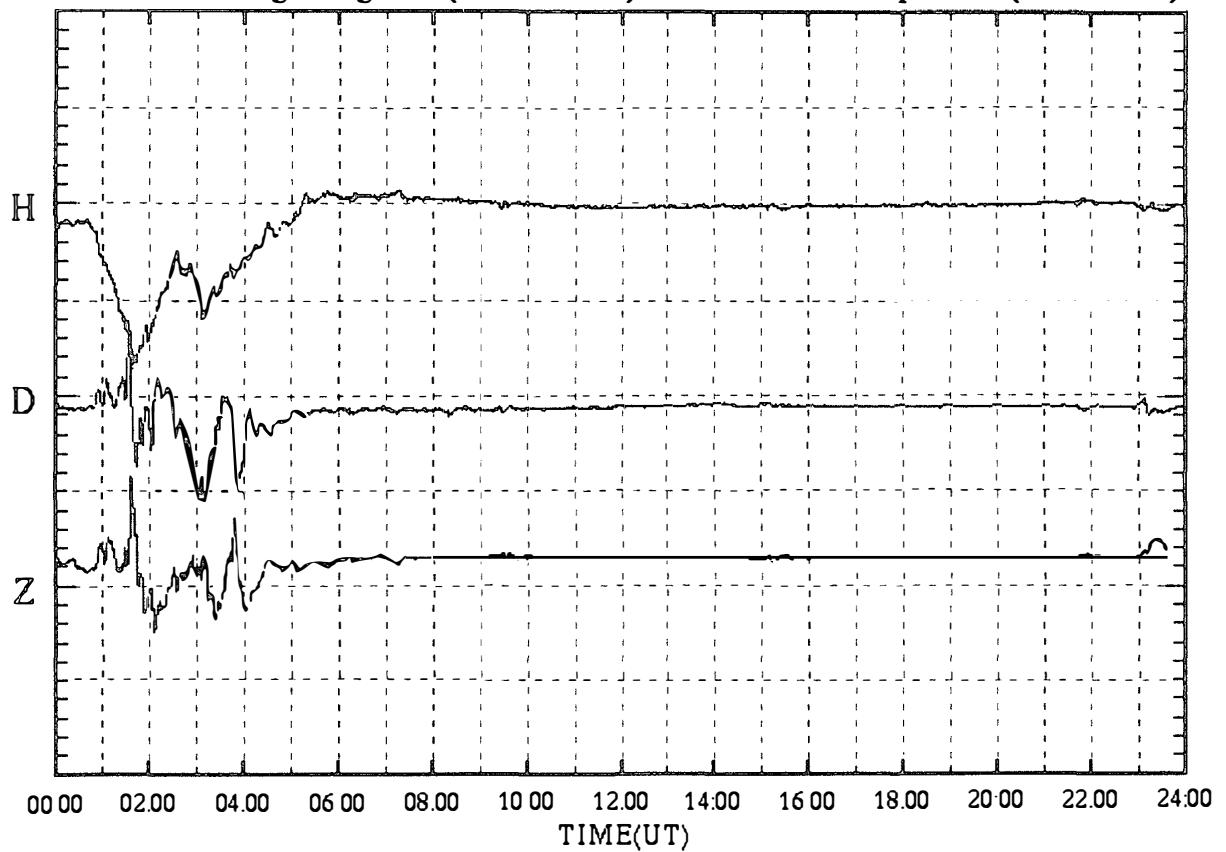

SYOWA magnetogram (100 nT/div)

12 Sep.1999 (DAY:255)

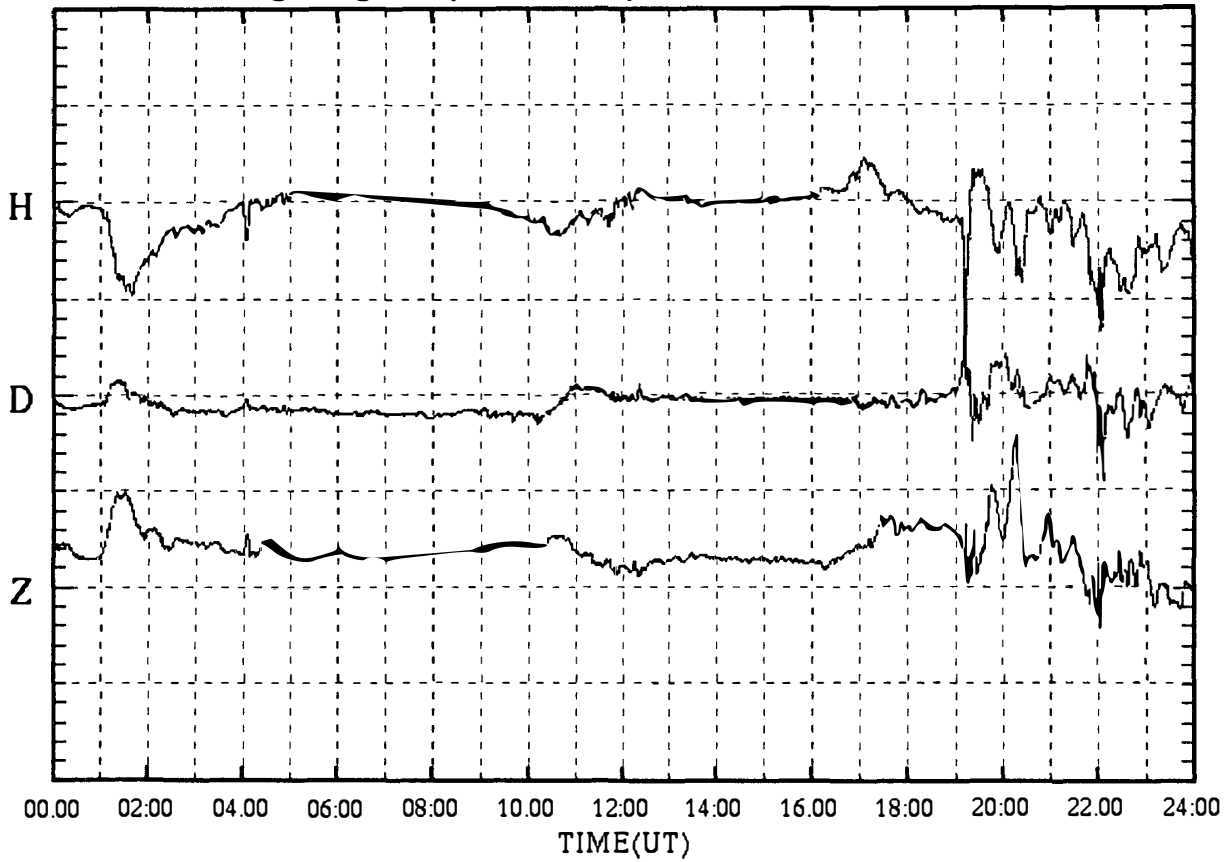

SYOWA magnetogram (100 nT/div)

13 Sep.1999 (DAY:256)

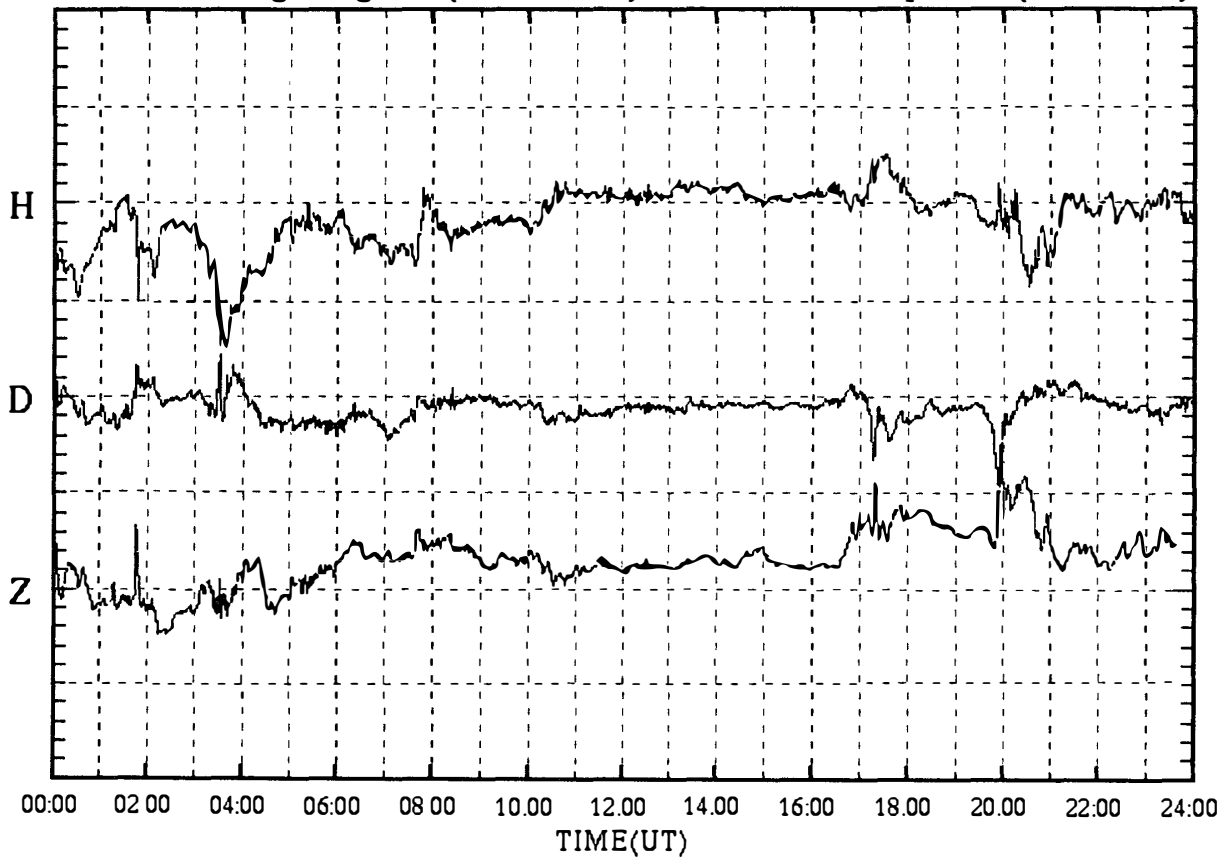



SYOWA magnetogram (100 nT/div)

14 Sep.1999 (DAY:257)

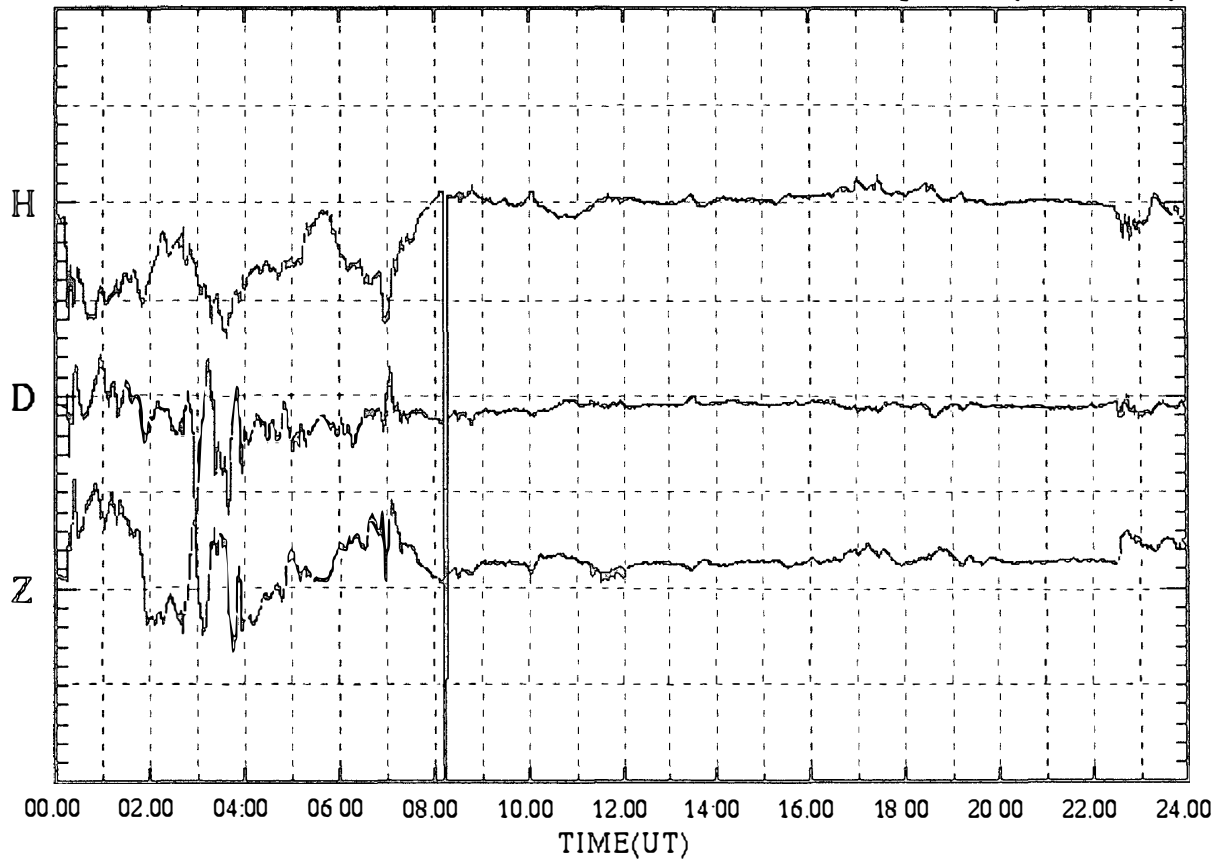

SYOWA magnetogram (100 nT/div)

15 Sep.1999 (DAY:258)

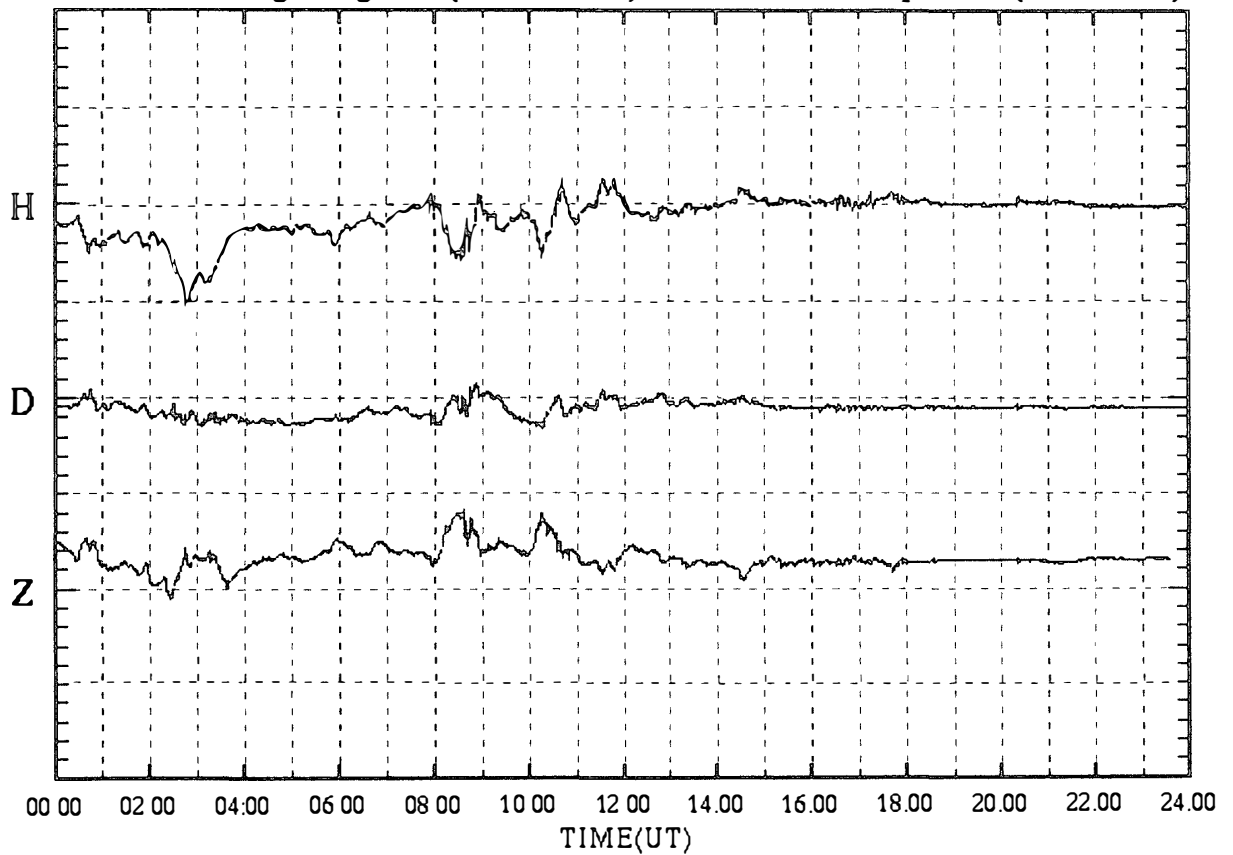

SYOWA magnetogram (100 nT/div)

16 Sep.1999 (DAY:259)

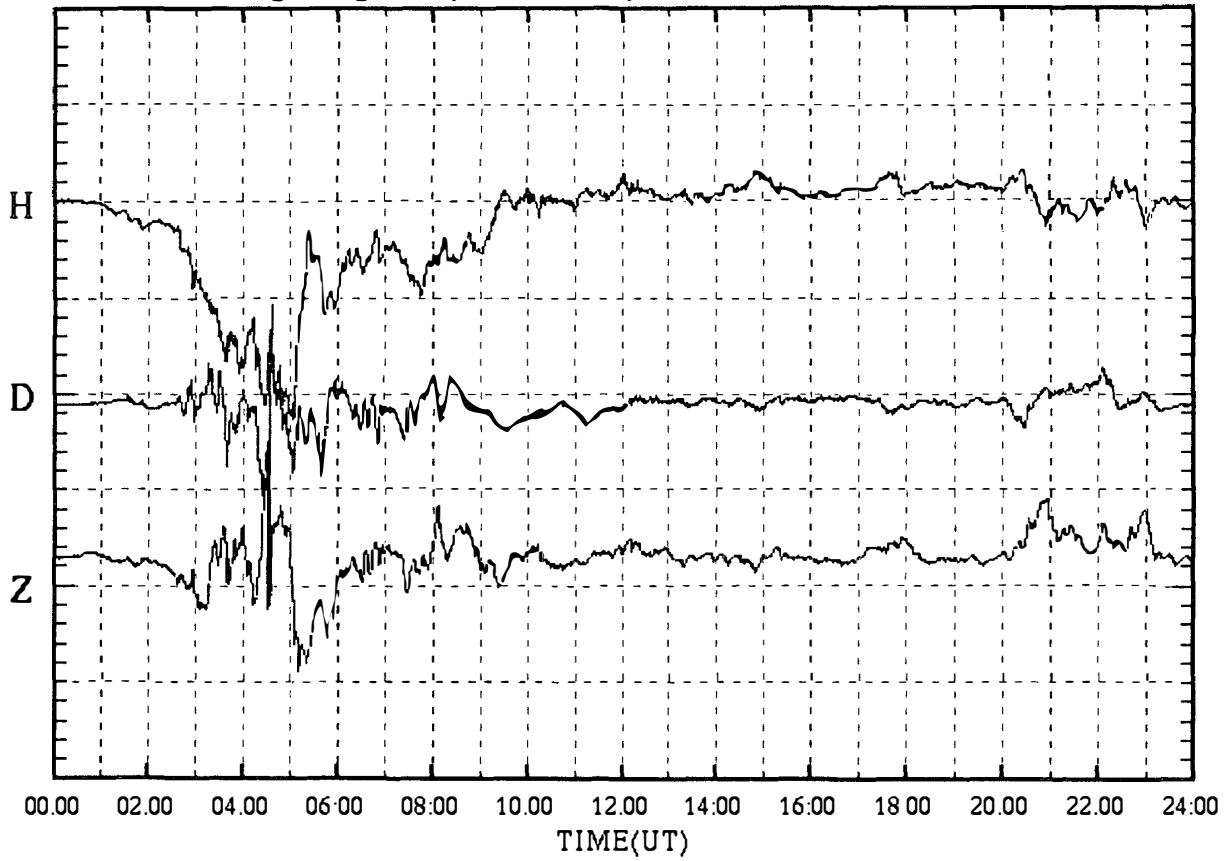

SYOWA magnetogram (100 nT/div)

17 Sep.1999 (DAY:260)

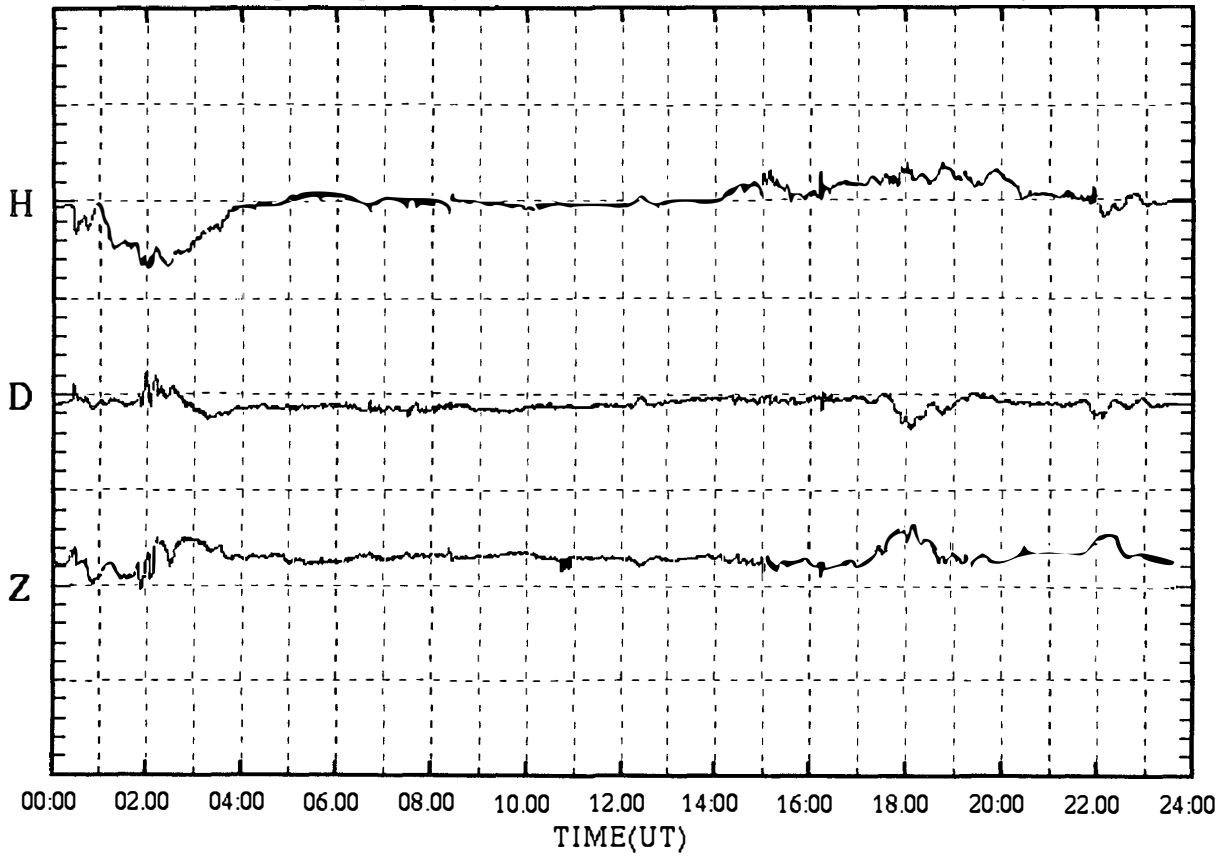

SYOWA magnetogram (100 nT/div)

18 Sep.1999 (DAY:261)

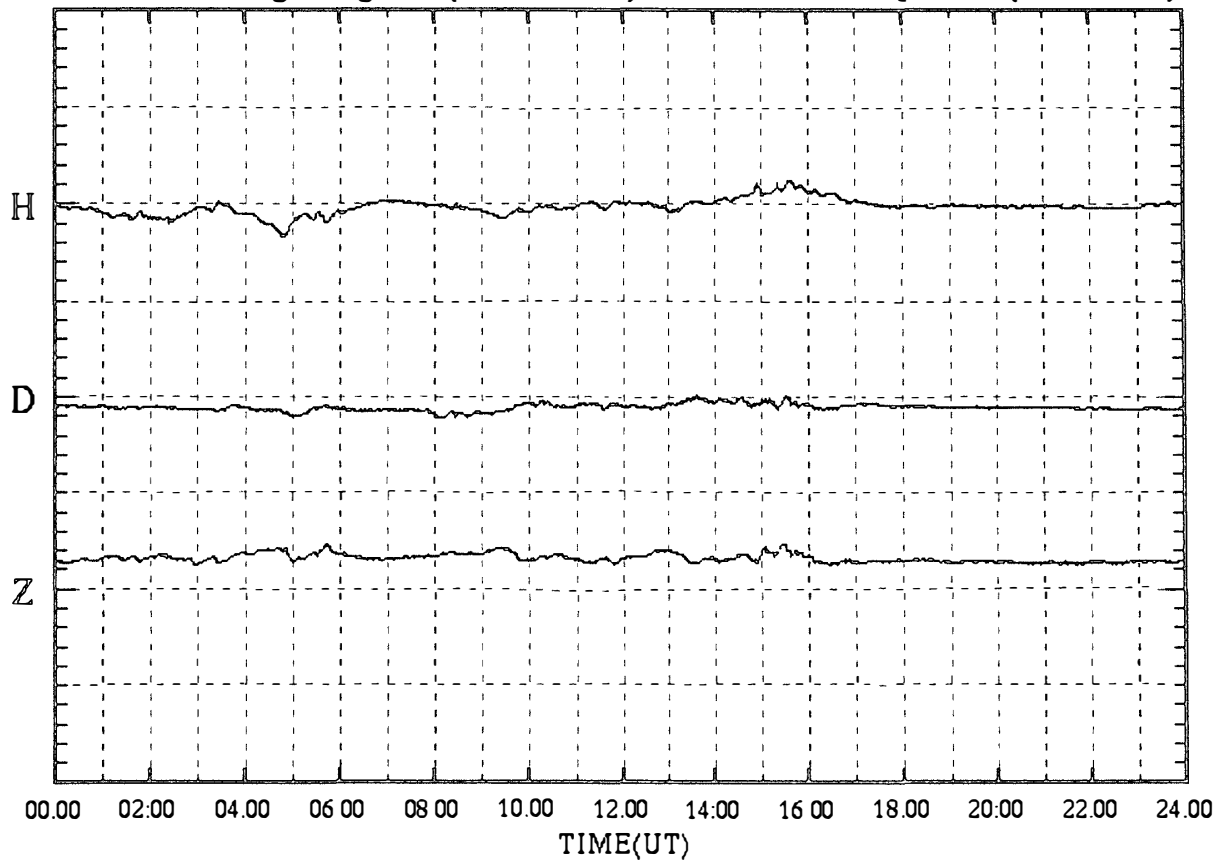

SYOWA magnetogram (100 nT/div)

19 Sep.1999 (DAY:262)

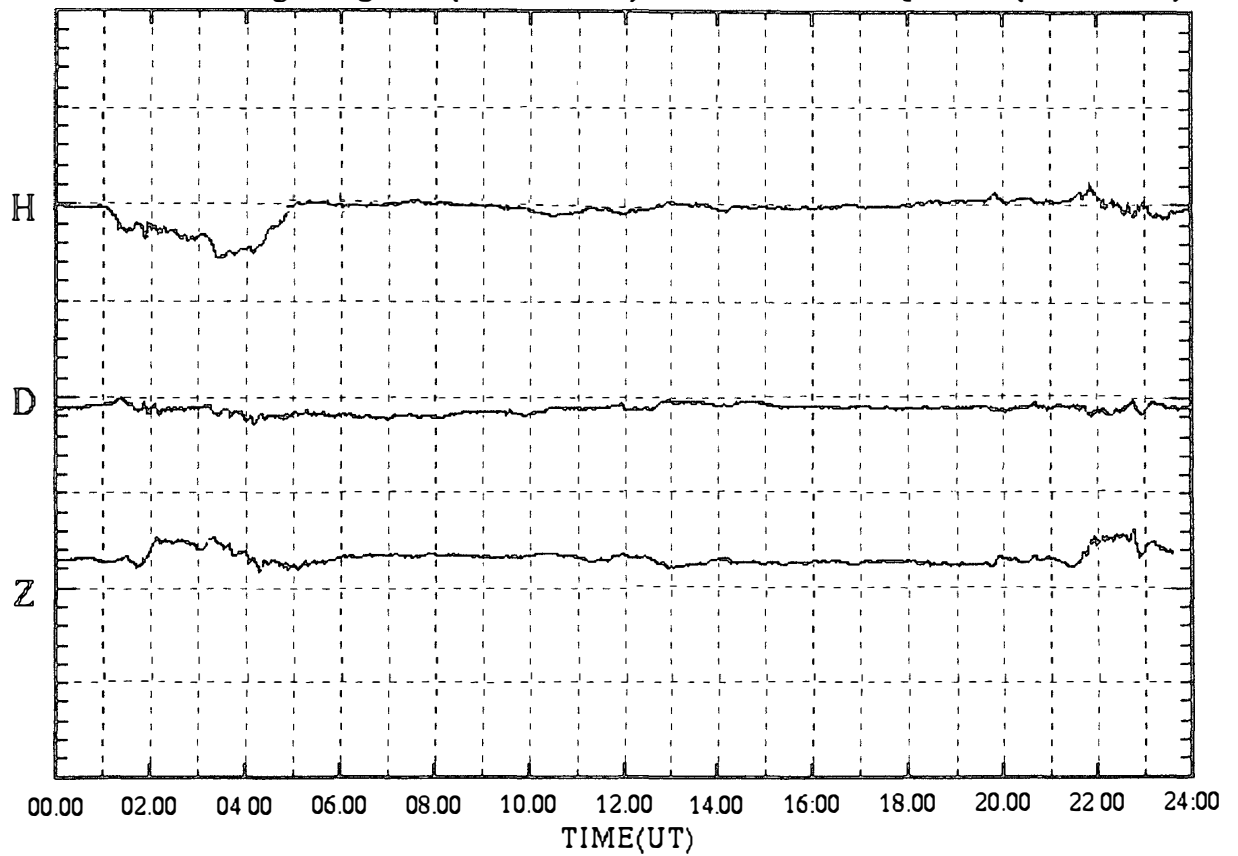

SYOWA magnetogram (100 nT/div)

20 Sep.1999 (DAY:263)

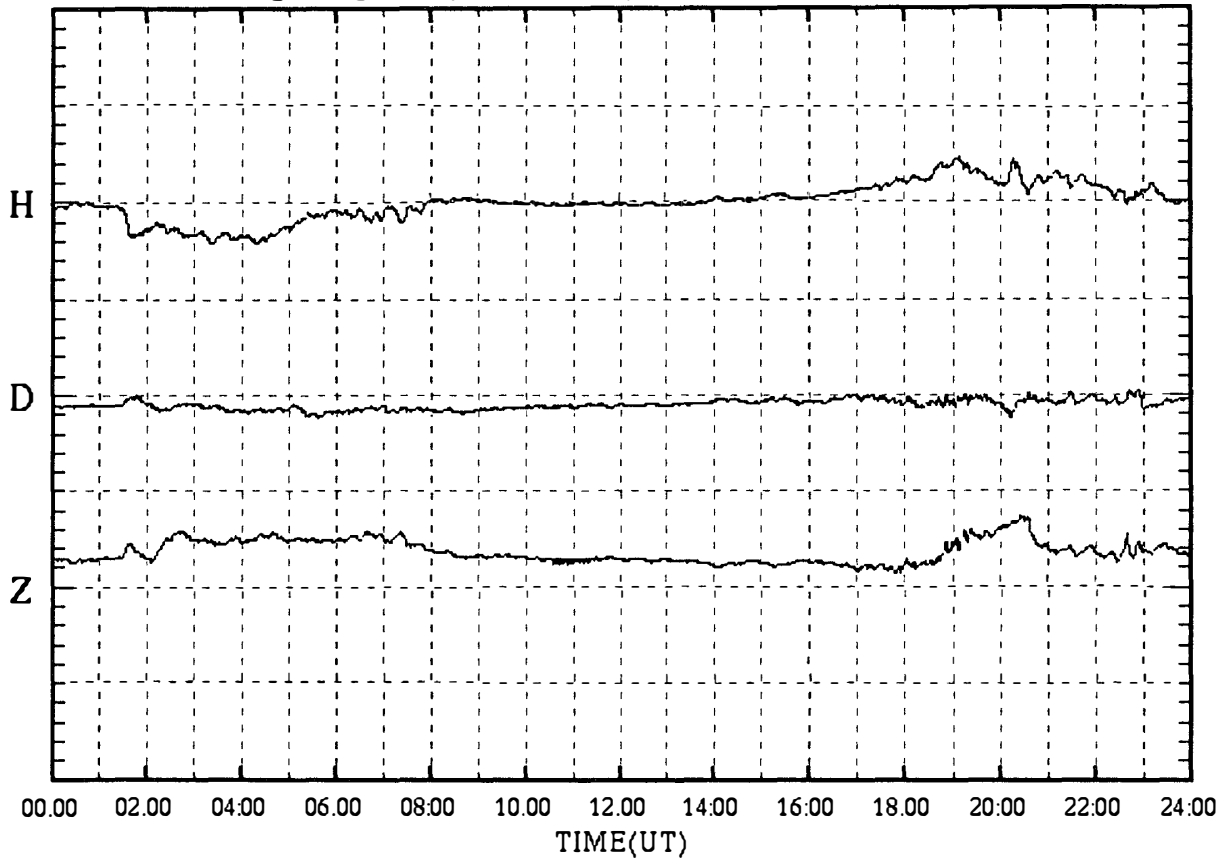

SYOWA magnetogram (100 nT/div)

21 Sep.1999 (DAY:264)

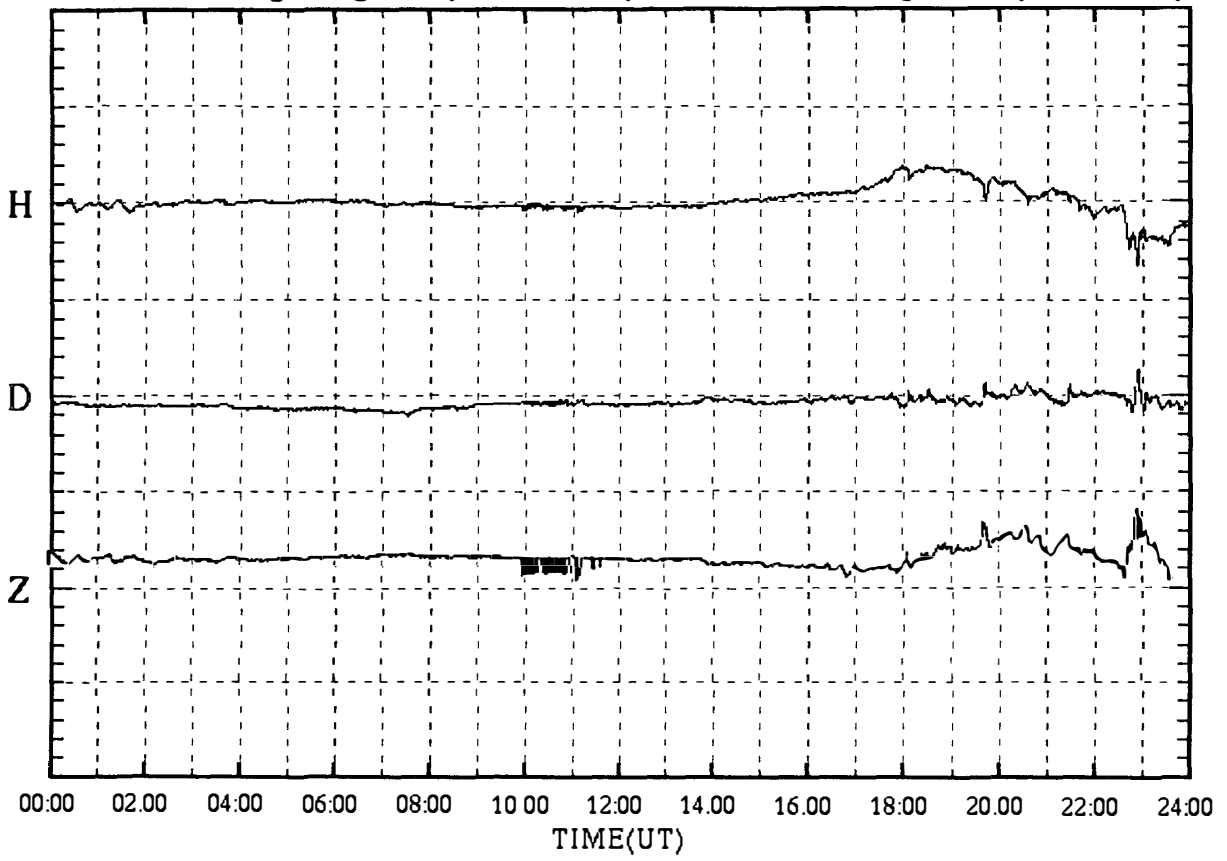

SYOWA magnetogram (100 nT/div)

22 Sep.1999 (DAY:265)

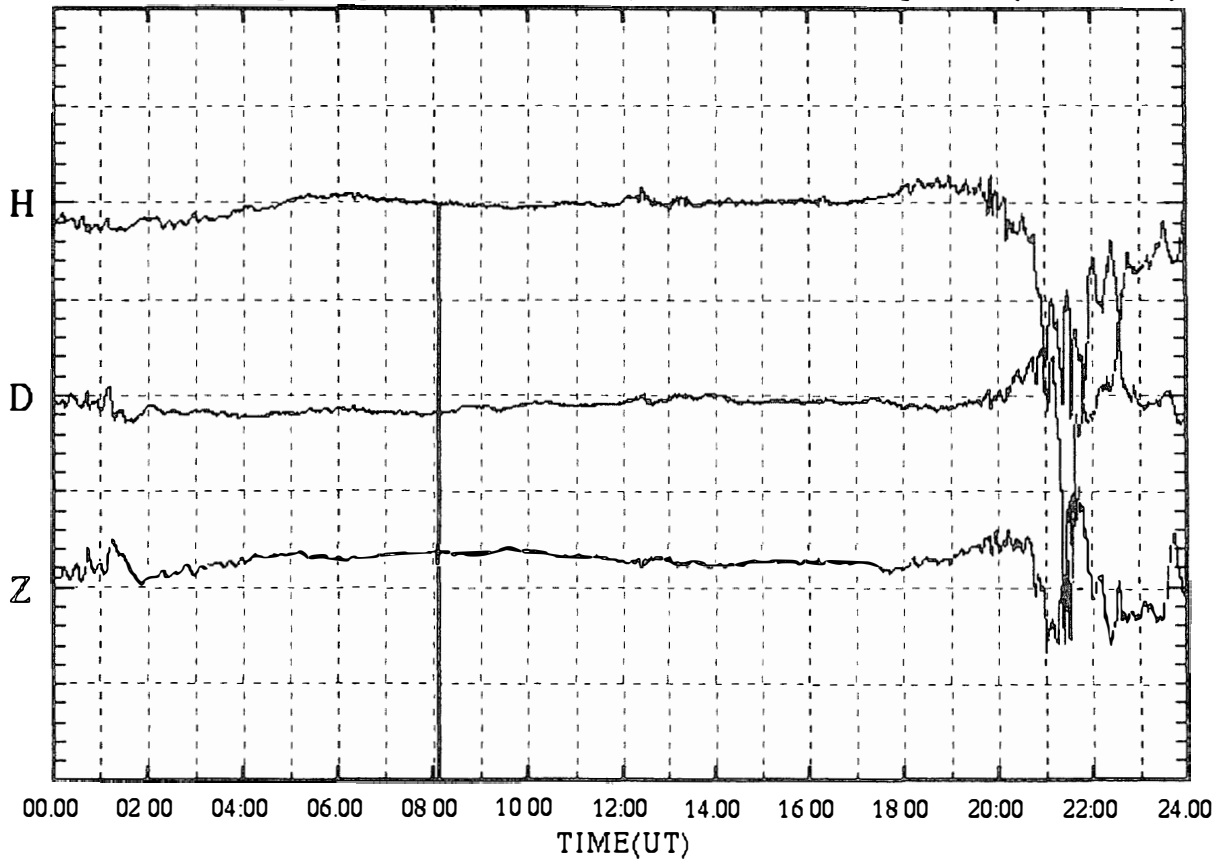

SYOWA magnetogram (100 nT/div)

23 Sep.1999 (DAY:266)

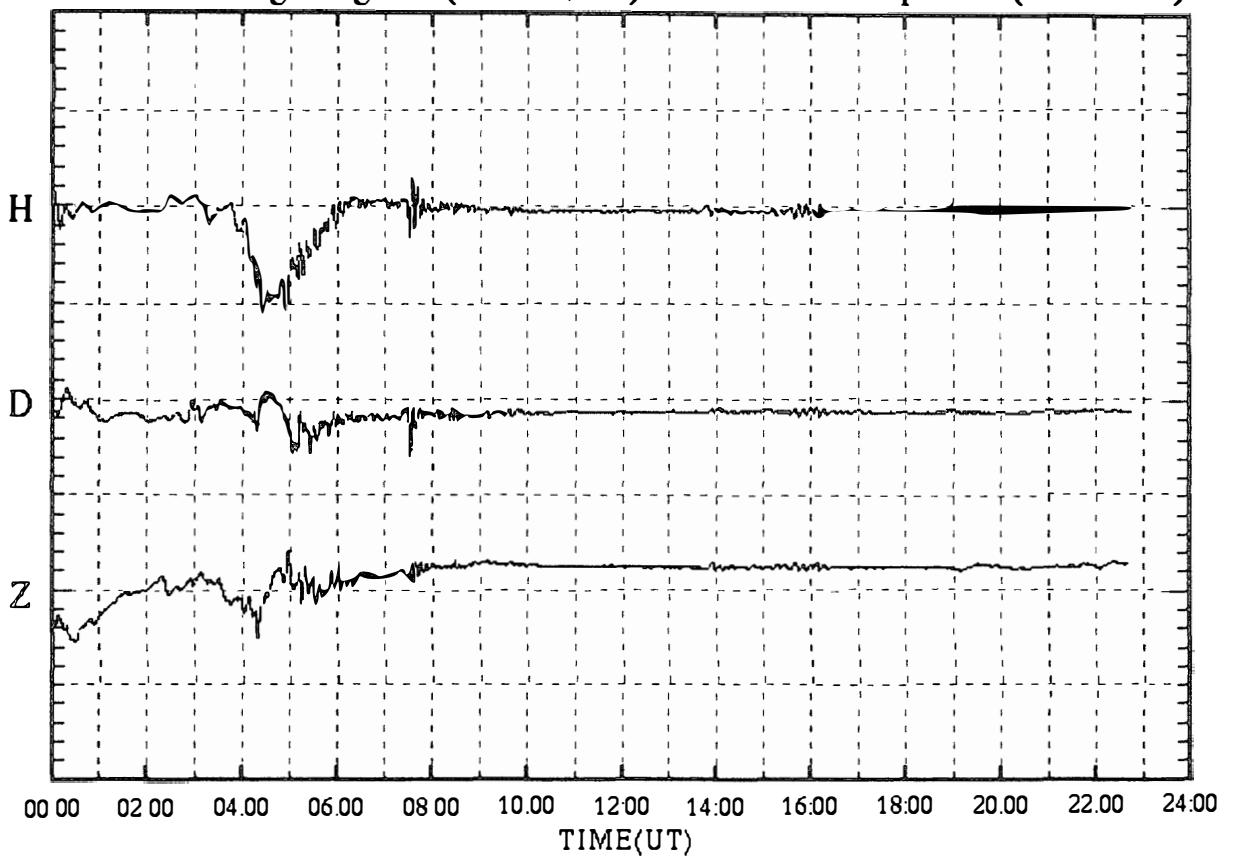

SYOWA magnetogram (100 nT/div)

24 Sep.1999 (DAY:267)

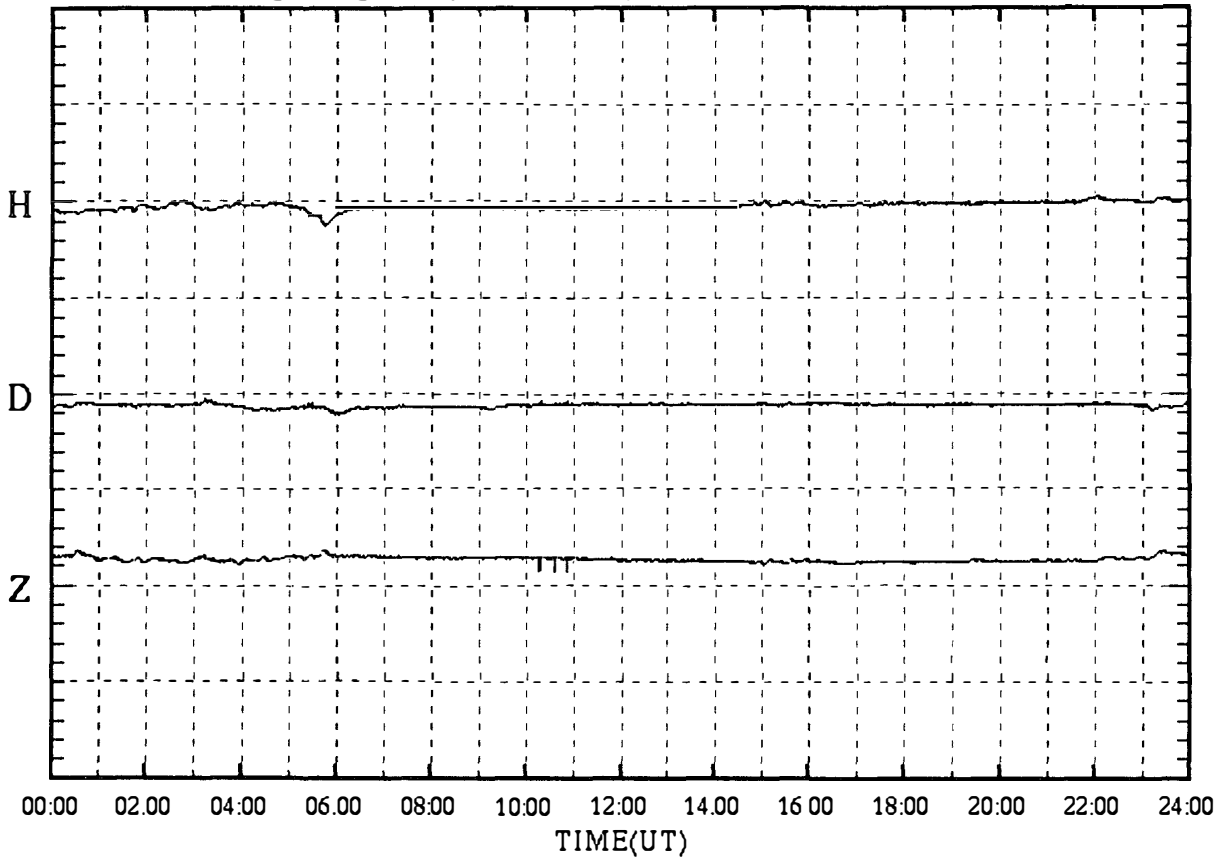

SYOWA magnetogram (100 nT/div)

25 Sep.1999 (DAY:268)

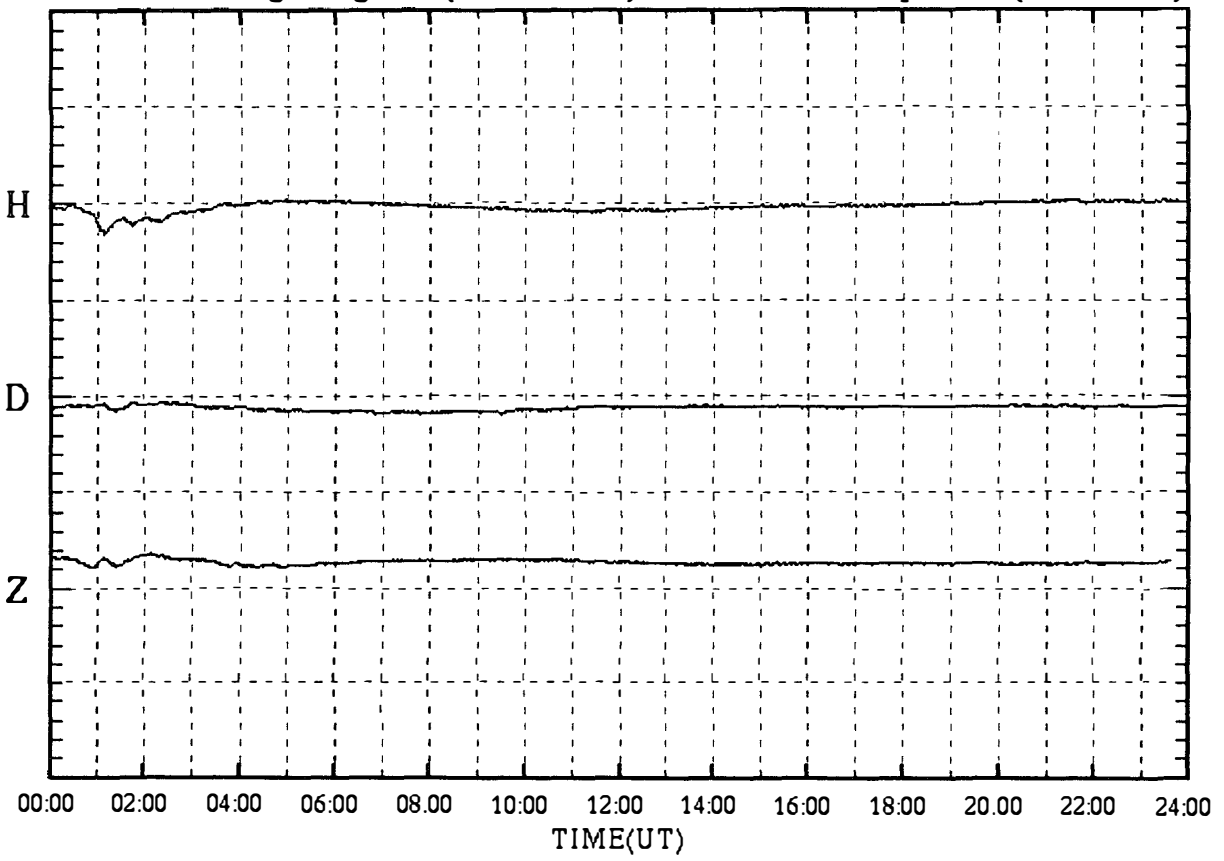

SYOWA magnetogram (100 nT/div)

26 Sep.1999 (DAY:269)

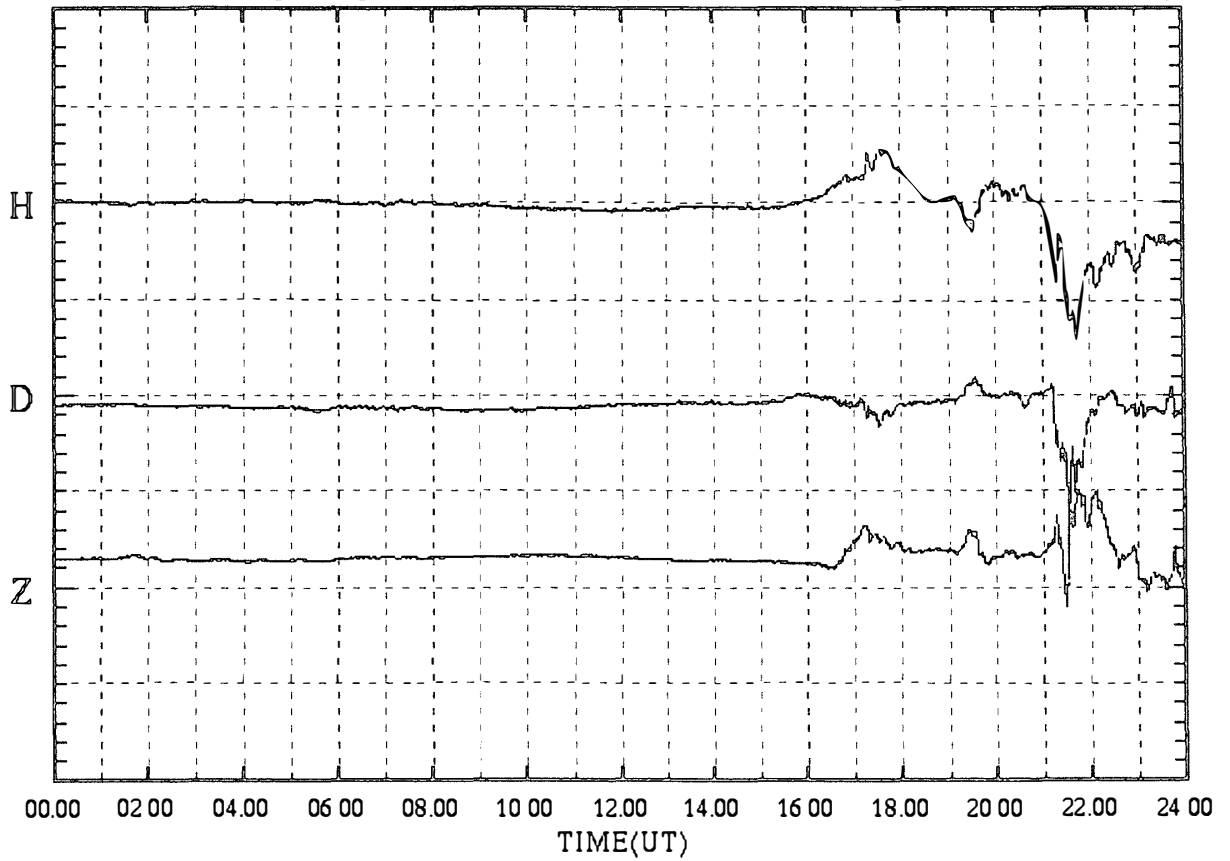

SYOWA magnetogram (100 nT/div)

27 Sep.1999 (DAY:270)

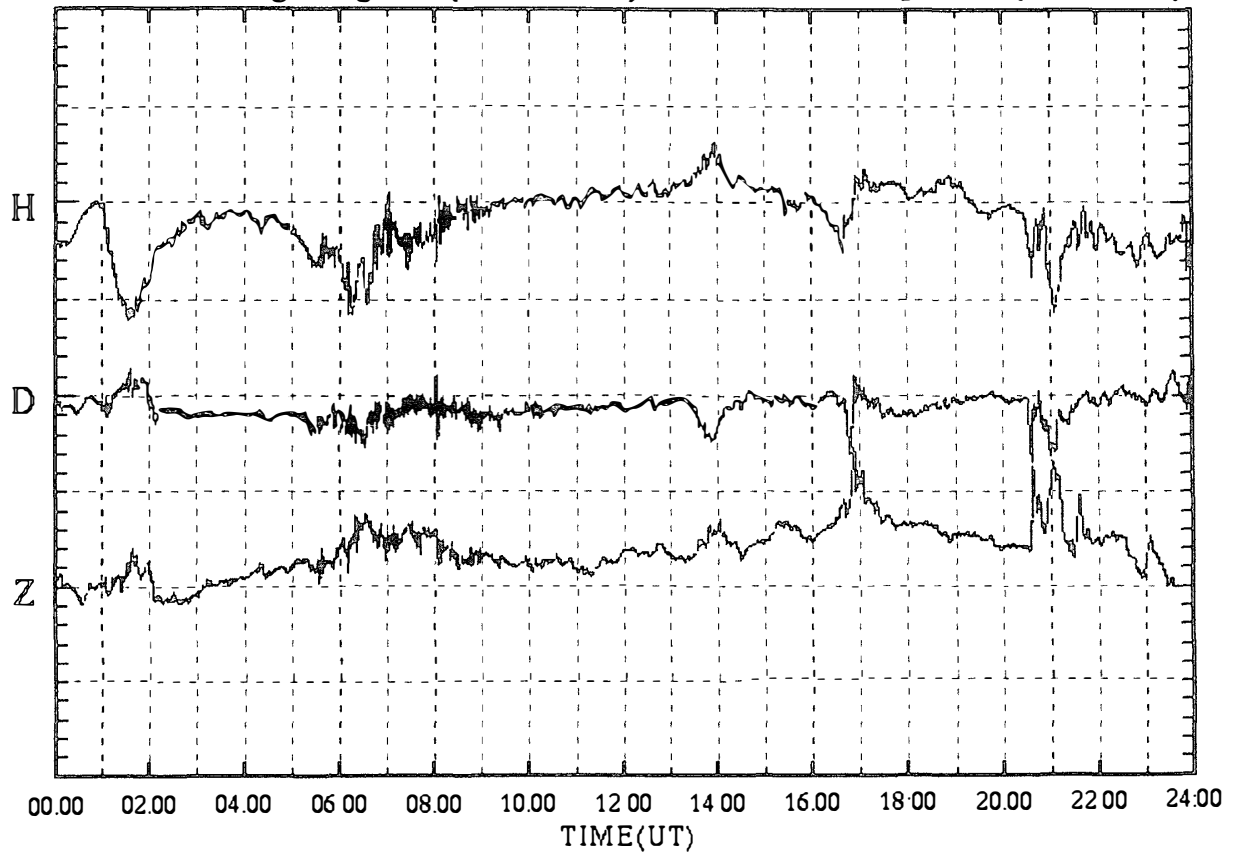

SYOWA magnetogram (100 nT/div)

28 Sep.1999 (DAY:271)

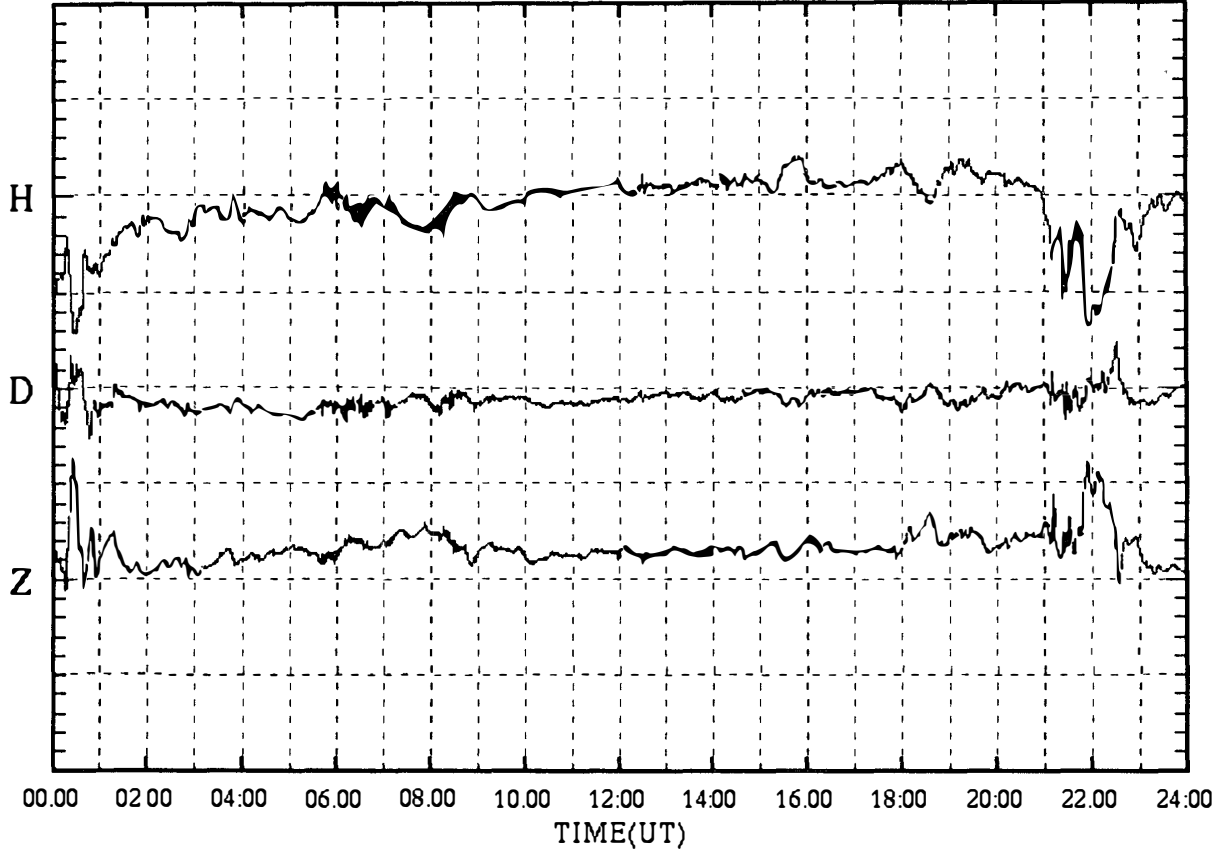

SYOWA magnetogram (100 nT/div)

29 Sep.1999 (DAY:272)

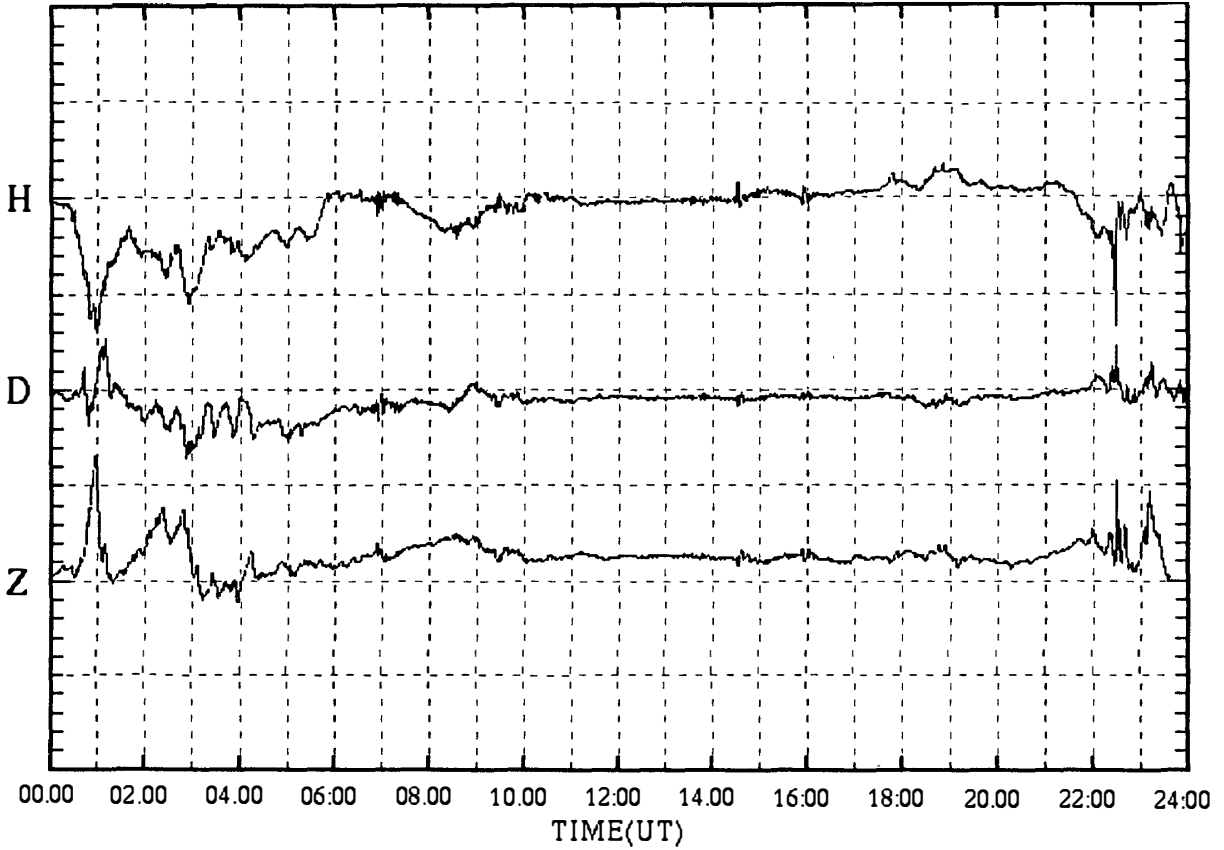



SYOWA magnetogram (100 nT/div)

30 Sep.1999 (DAY:273)

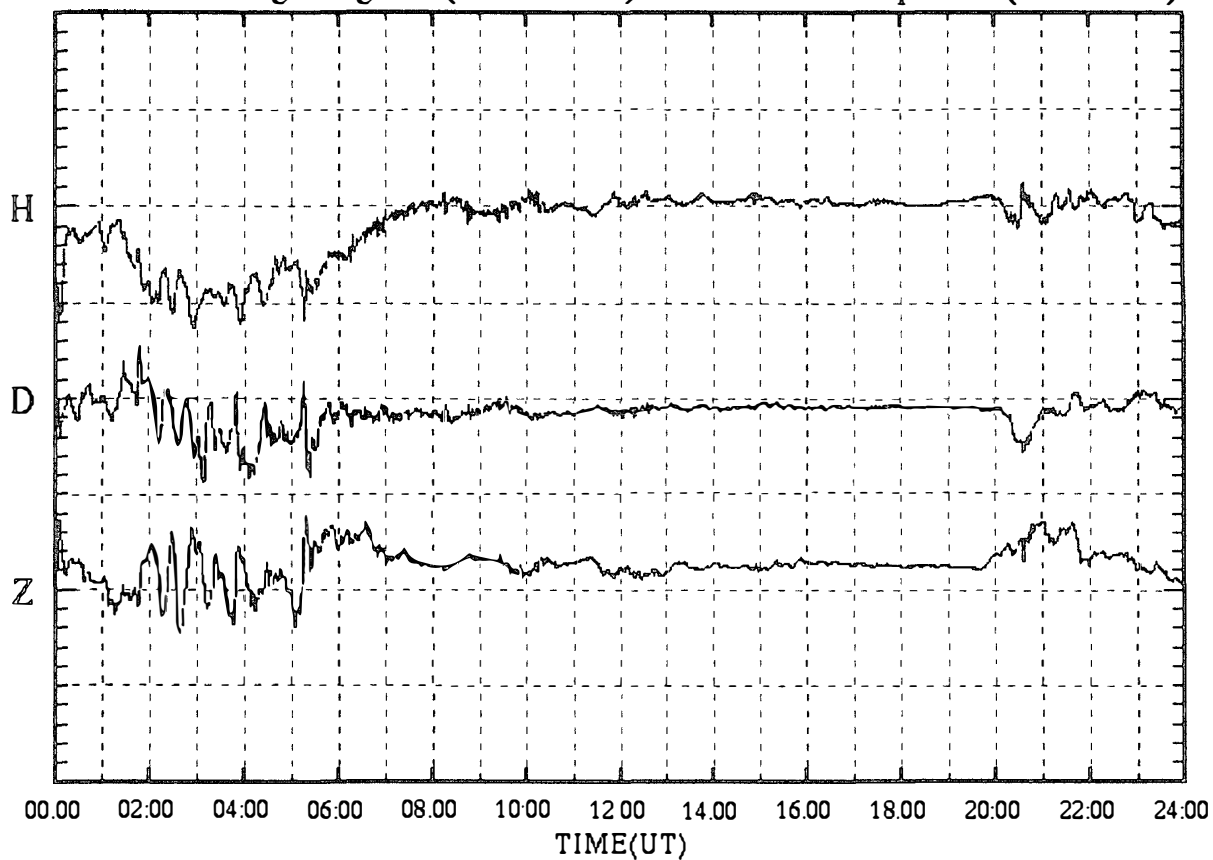

SYOWA magnetogram (100 nT/div)

01 Oct.1999 (DAY:274)

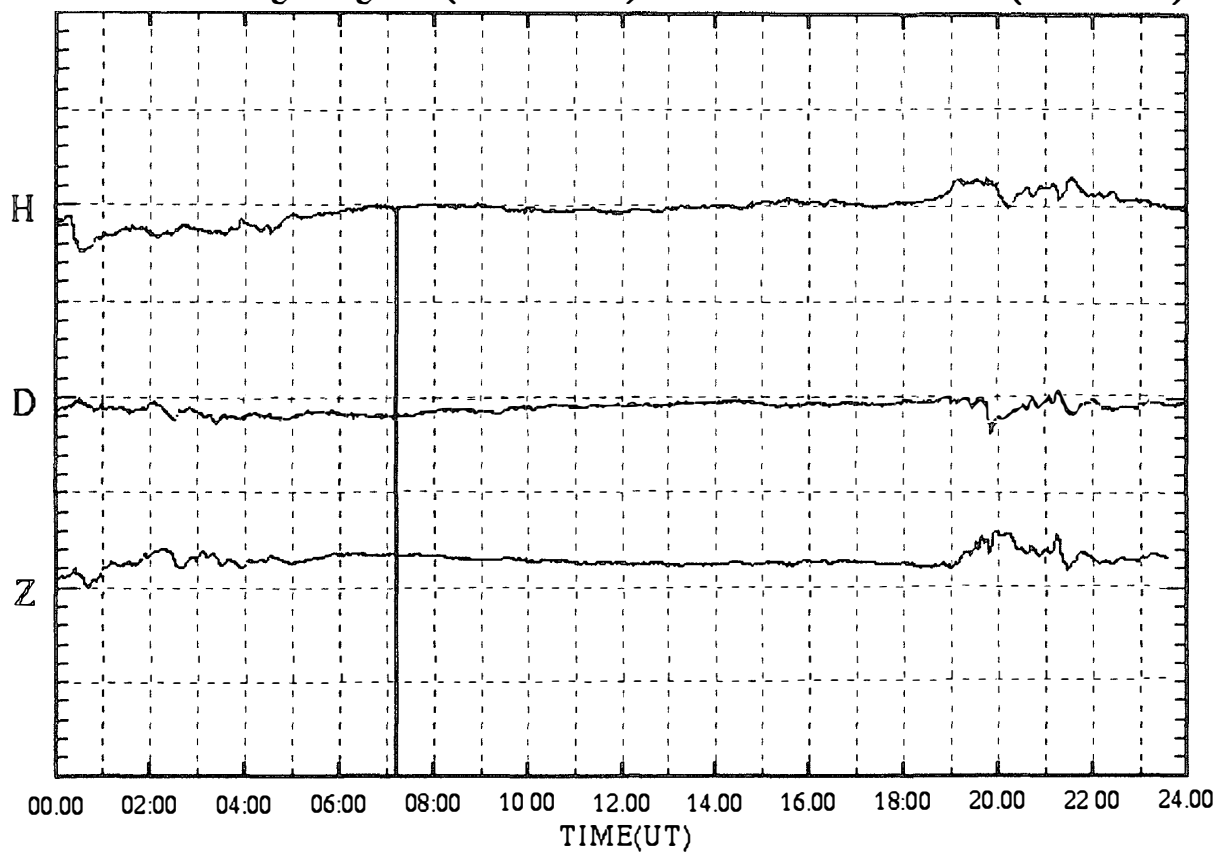

SYOWA magnetogram (100 nT/div)

02 Oct.1999 (DAY:275)

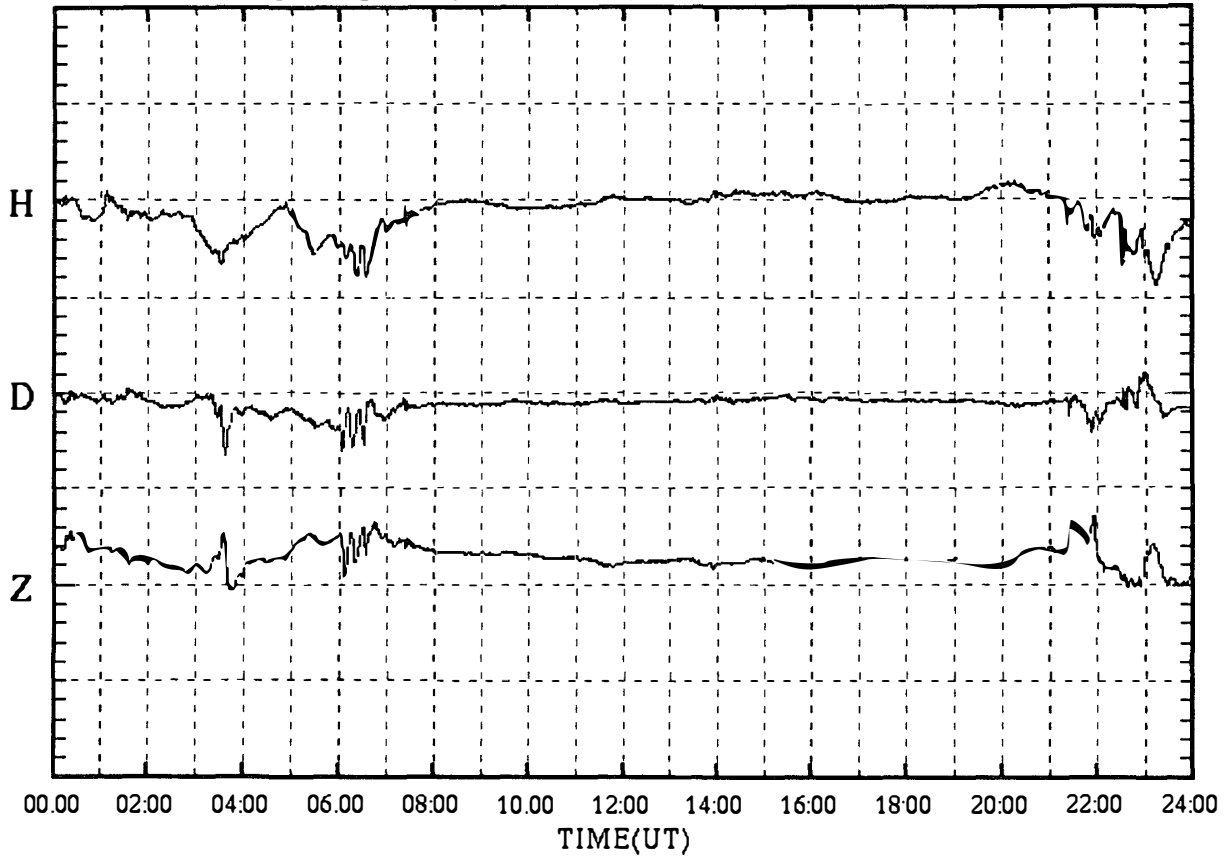

SYOWA magnetogram (100 nT/div)

03 Oct.1999 (DAY:276)

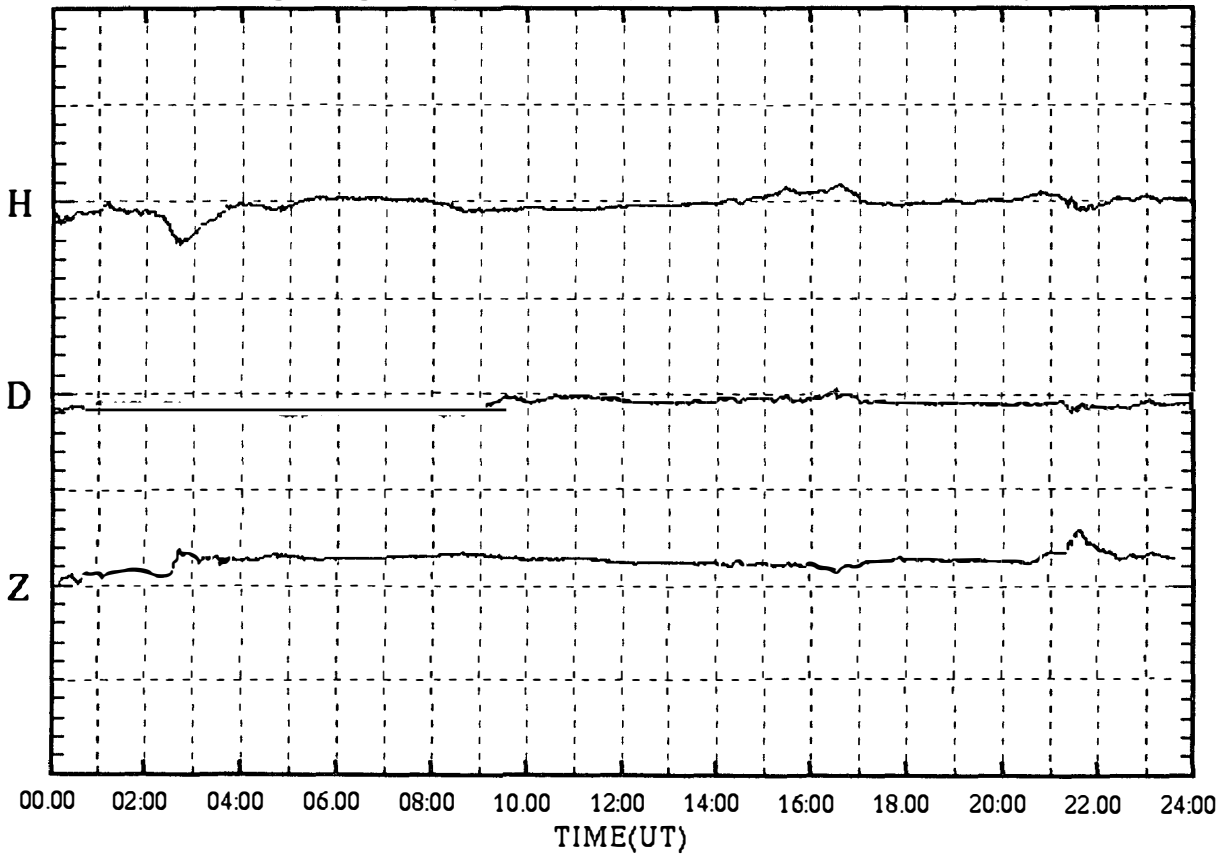

SYOWA magnetogram (100 nT/div)

04 Oct.1999 (DAY:277)

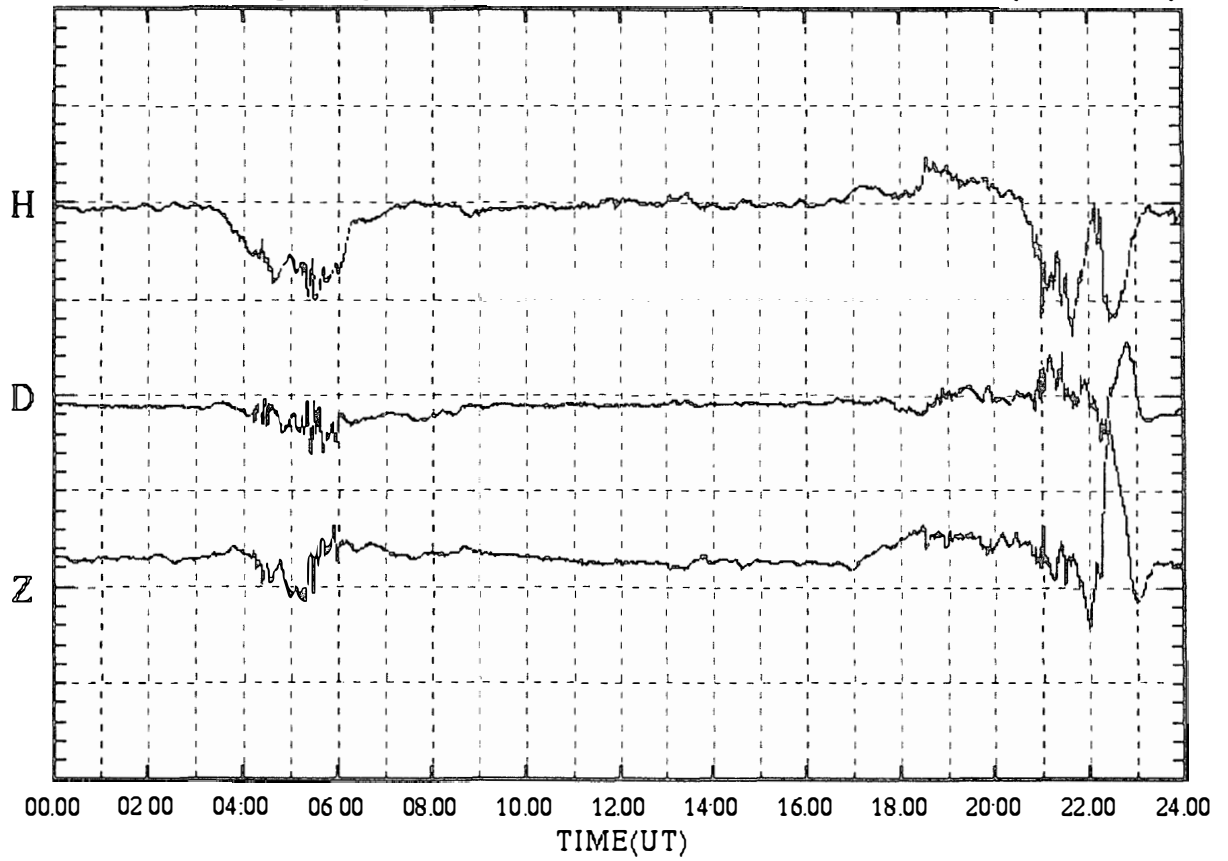

SYOWA magnetogram (100 nT/div)

05 Oct.1999 (DAY:278)

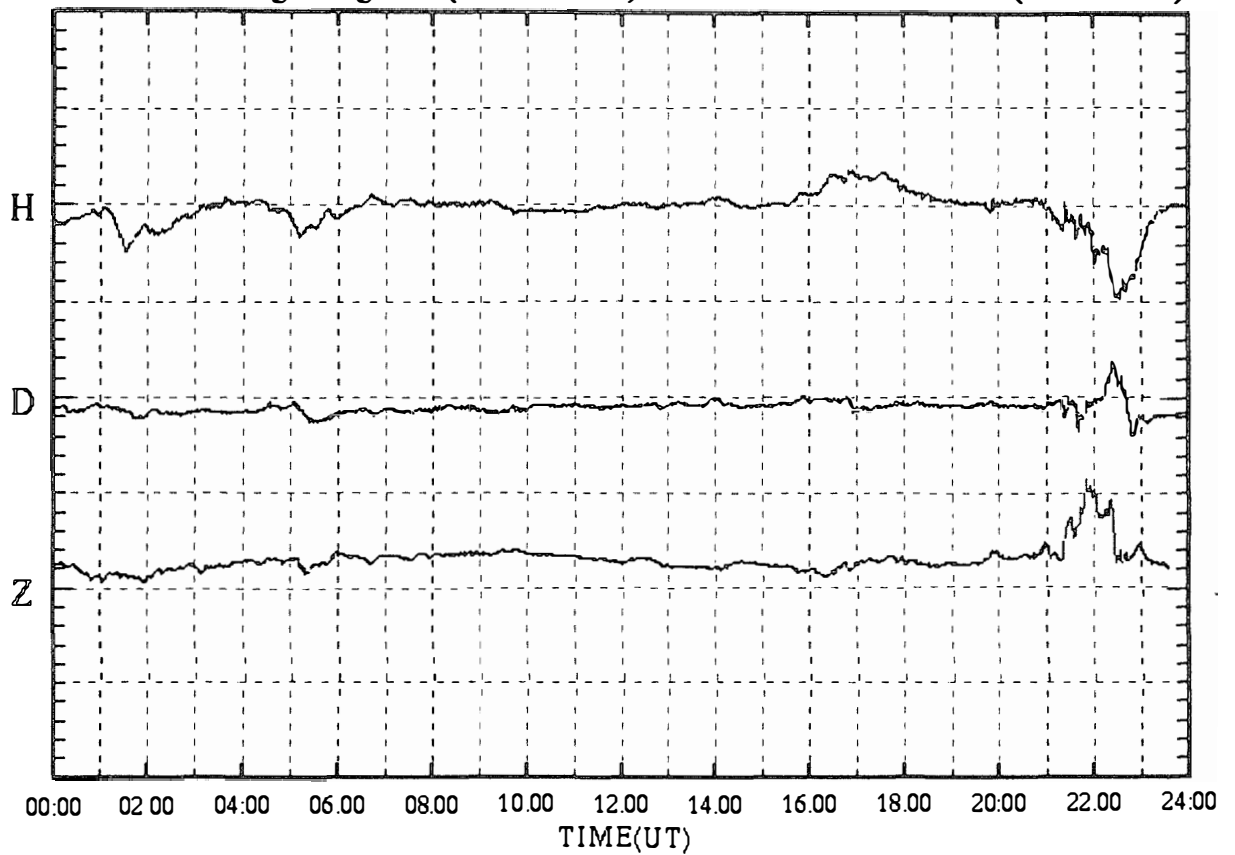

SYOWA magnetogram (100 nT/div)

06 Oct.1999 (DAY:279)

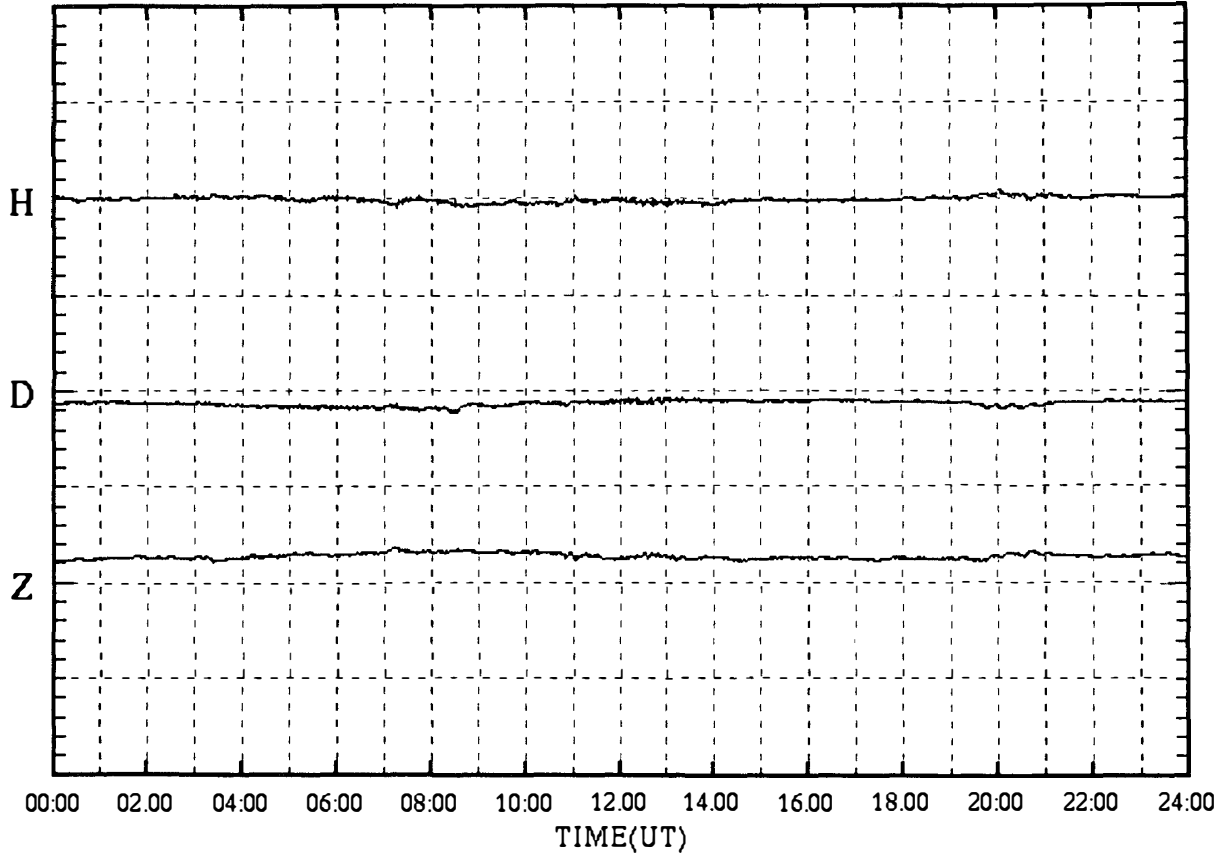

SYOWA magnetogram (100 nT/div)

07 Oct.1999 (DAY:280)

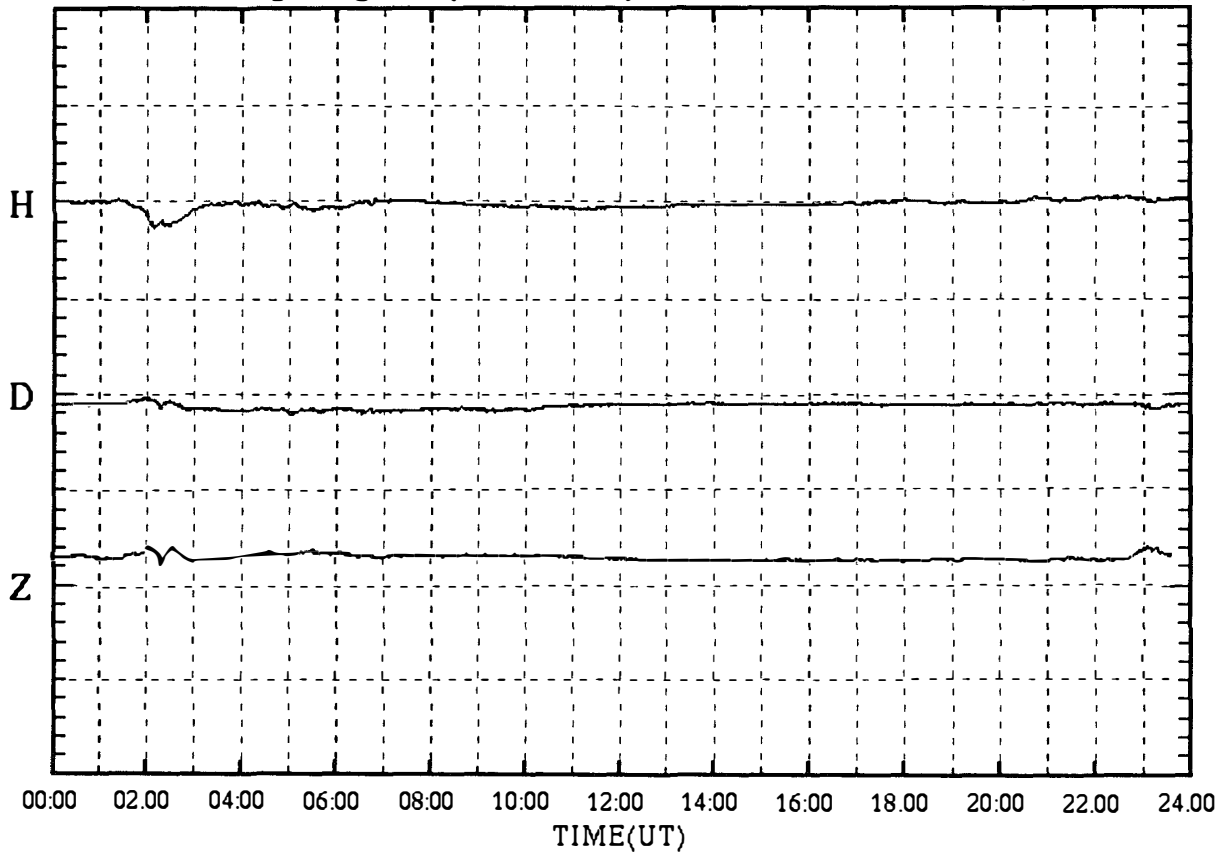

SYOWA magnetogram (100 nT/div)

08 Oct.1999 (DAY:281)

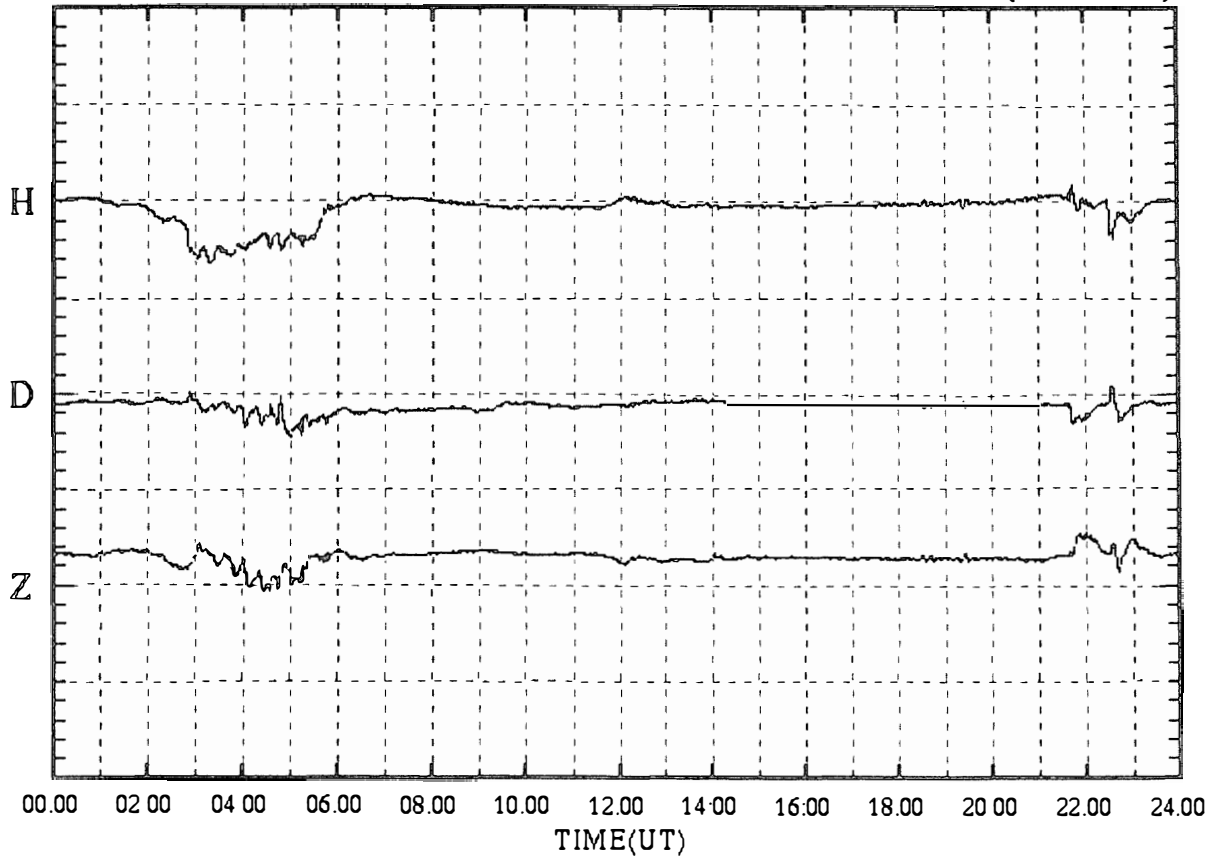

SYOWA magnetogram (100 nT/div)

09 Oct.1999 (DAY:282)

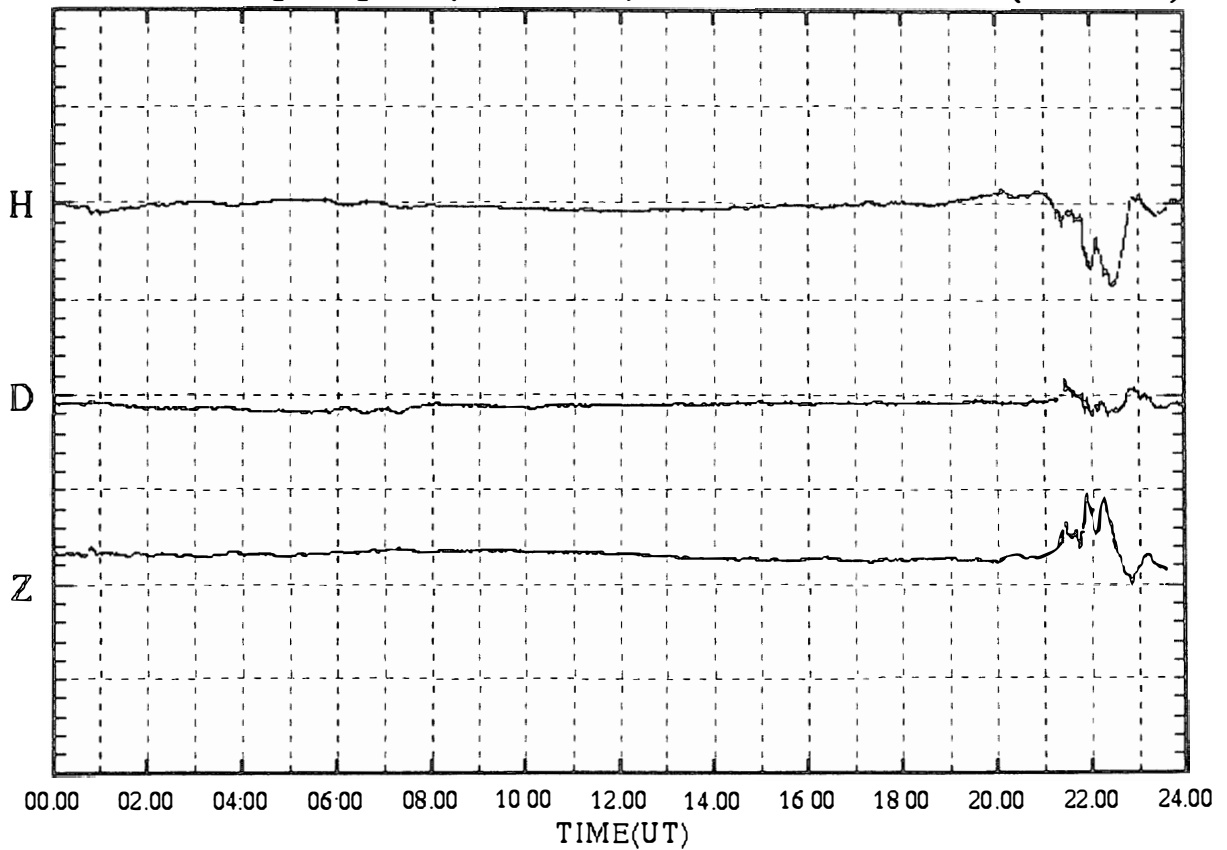

SYOWA magnetogram (100 nT/div)

10 Oct.1999 (DAY:283)

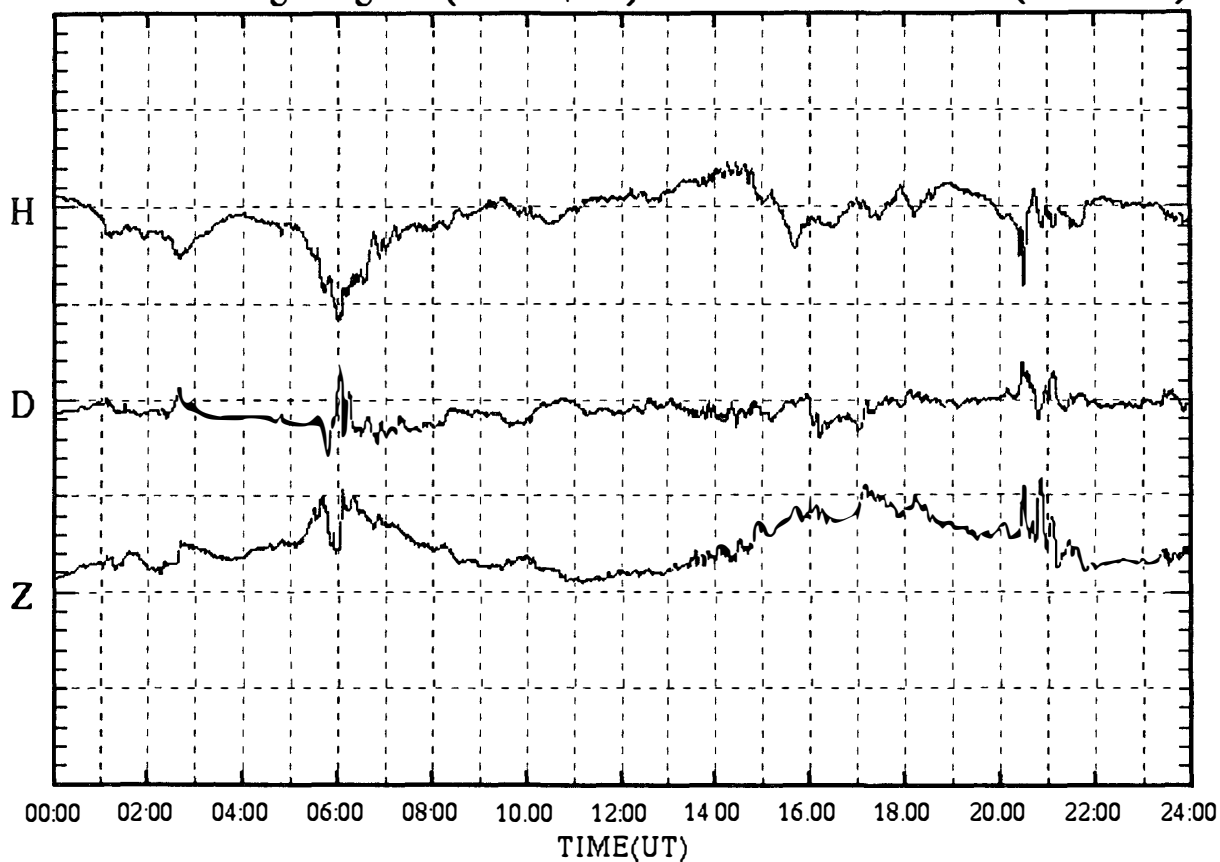

SYOWA magnetogram (100 nT/div)

11 Oct.1999 (DAY:284)

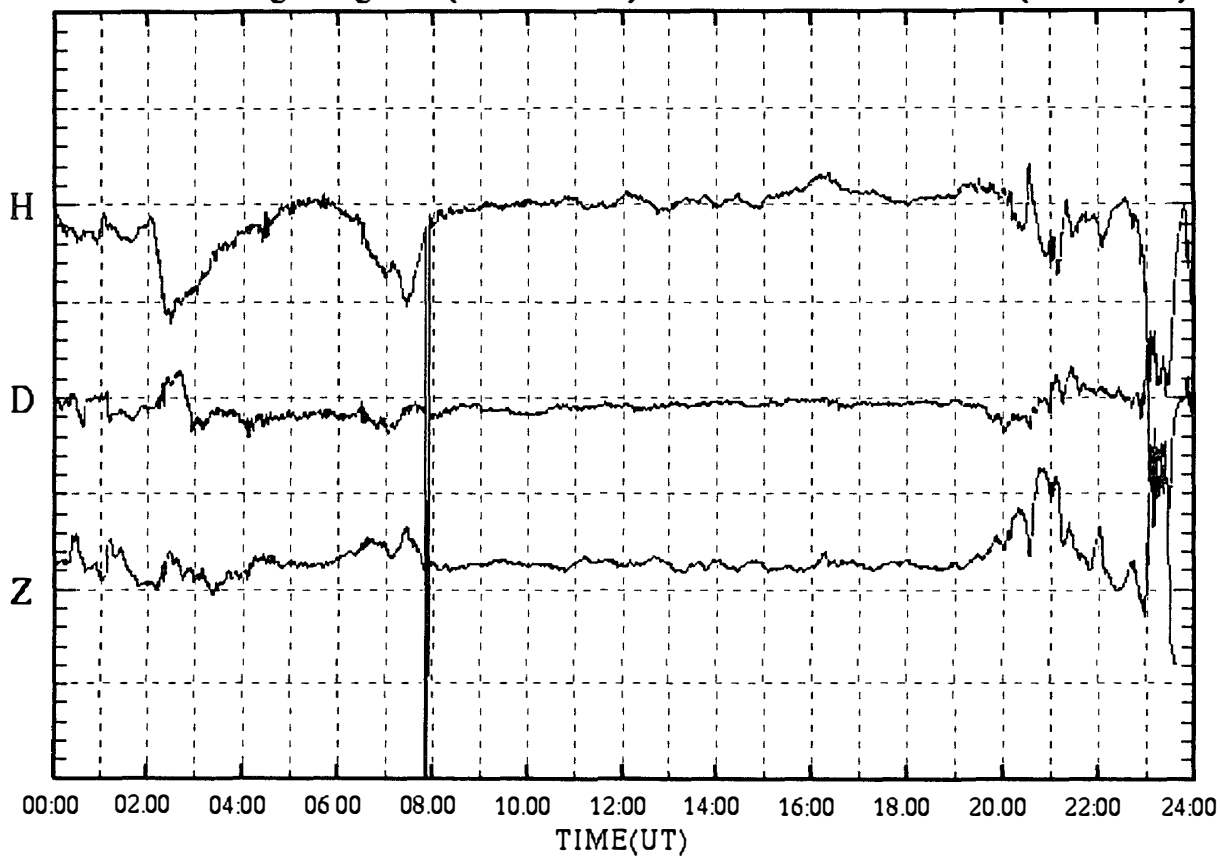

SYOWA magnetogram (100 nT/div)

12 Oct.1999 (DAY:285)

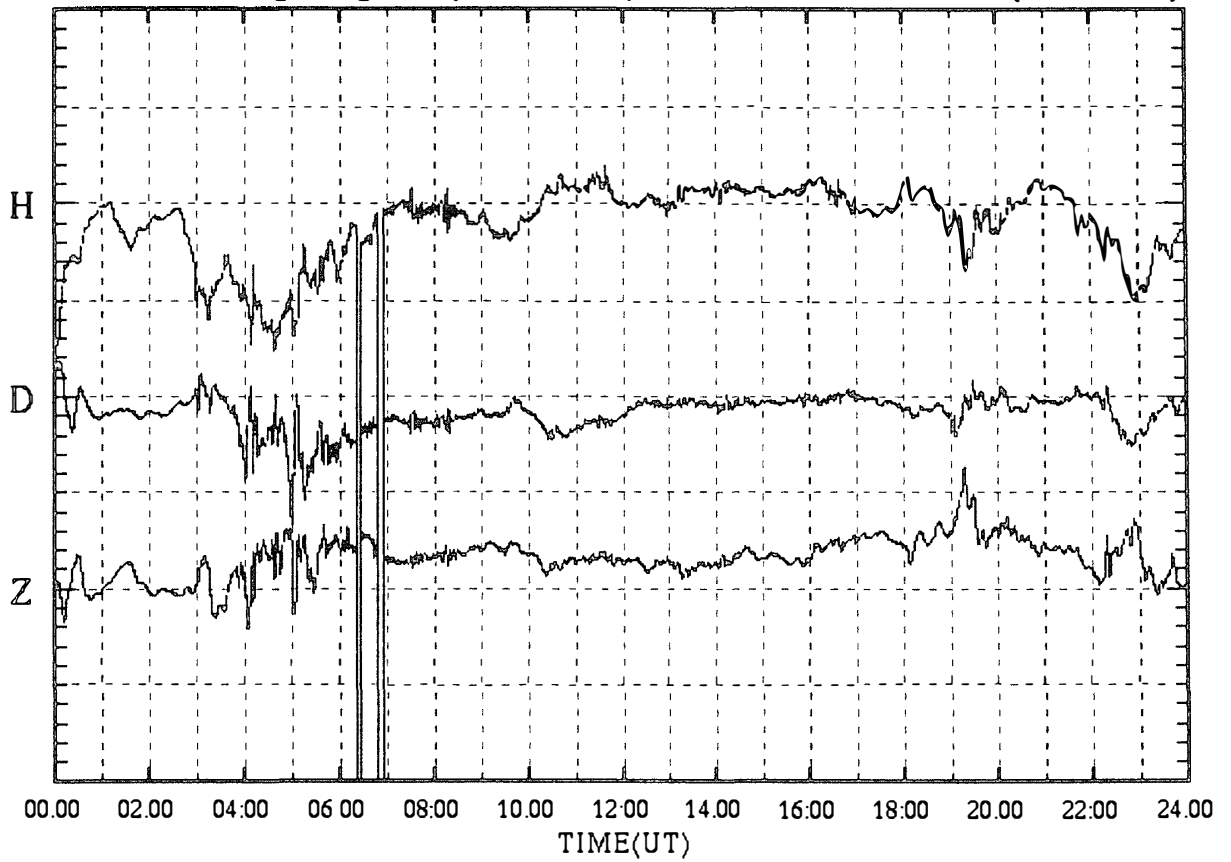

SYOWA magnetogram (100 nT/div)

13 Oct.1999 (DAY:286)

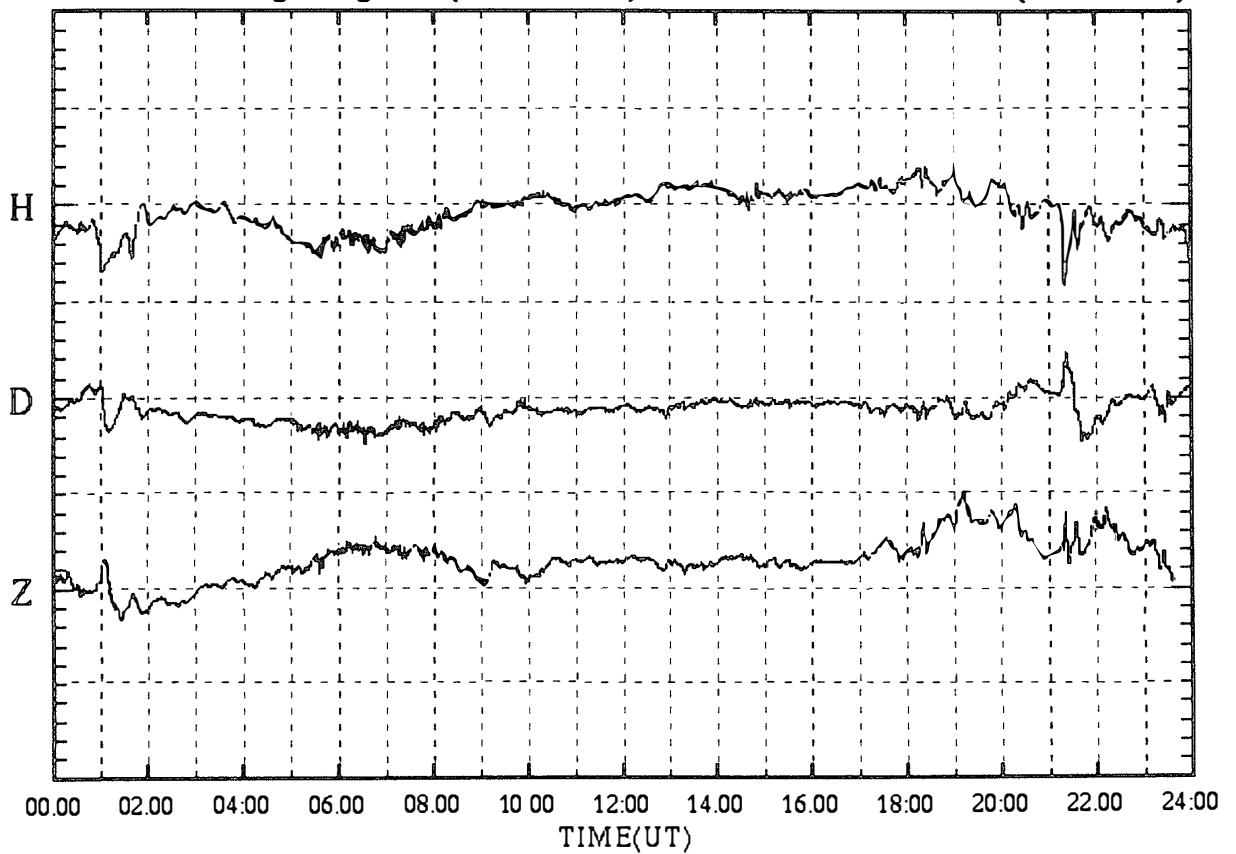

SYOWA magnetogram (100 nT/div)

14 Oct.1999 (DAY:287)

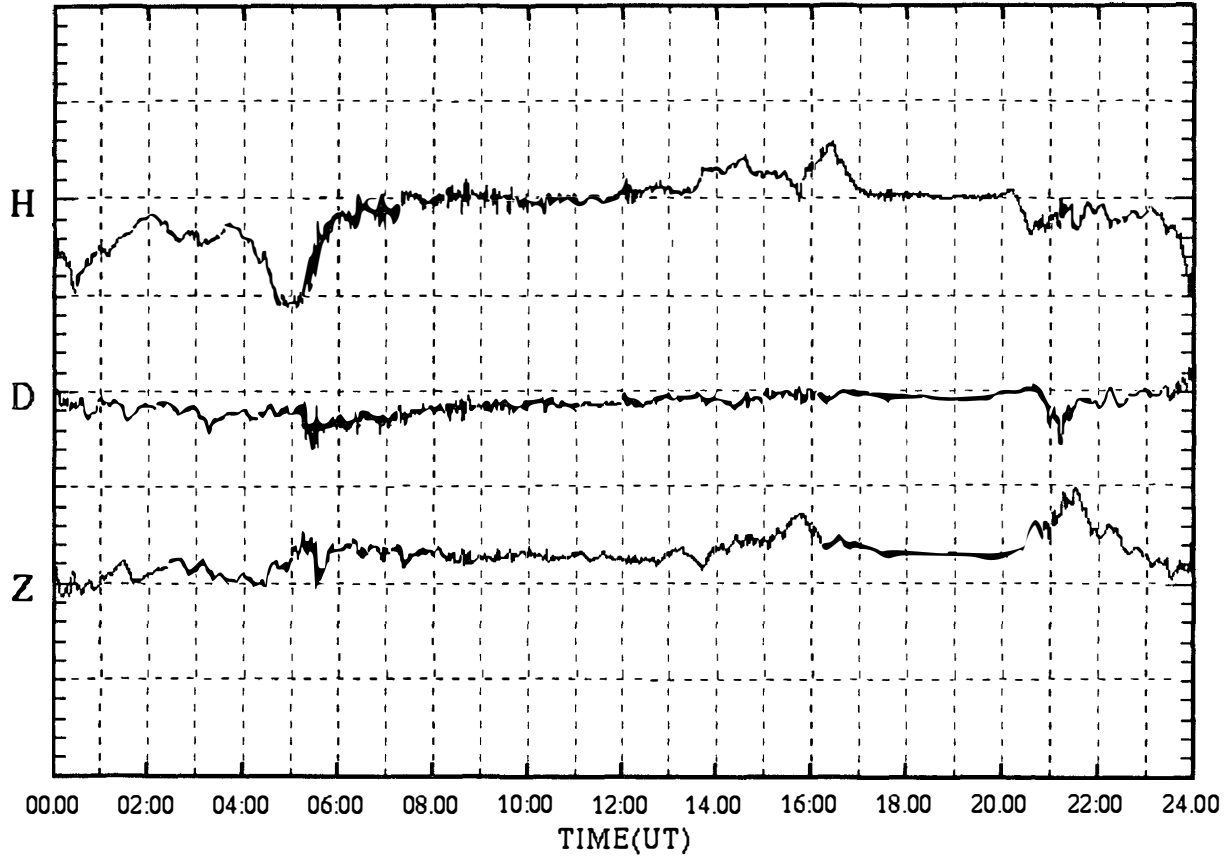

SYOWA magnetogram (100 nT/div)

15 Oct.1999 (DAY:288)

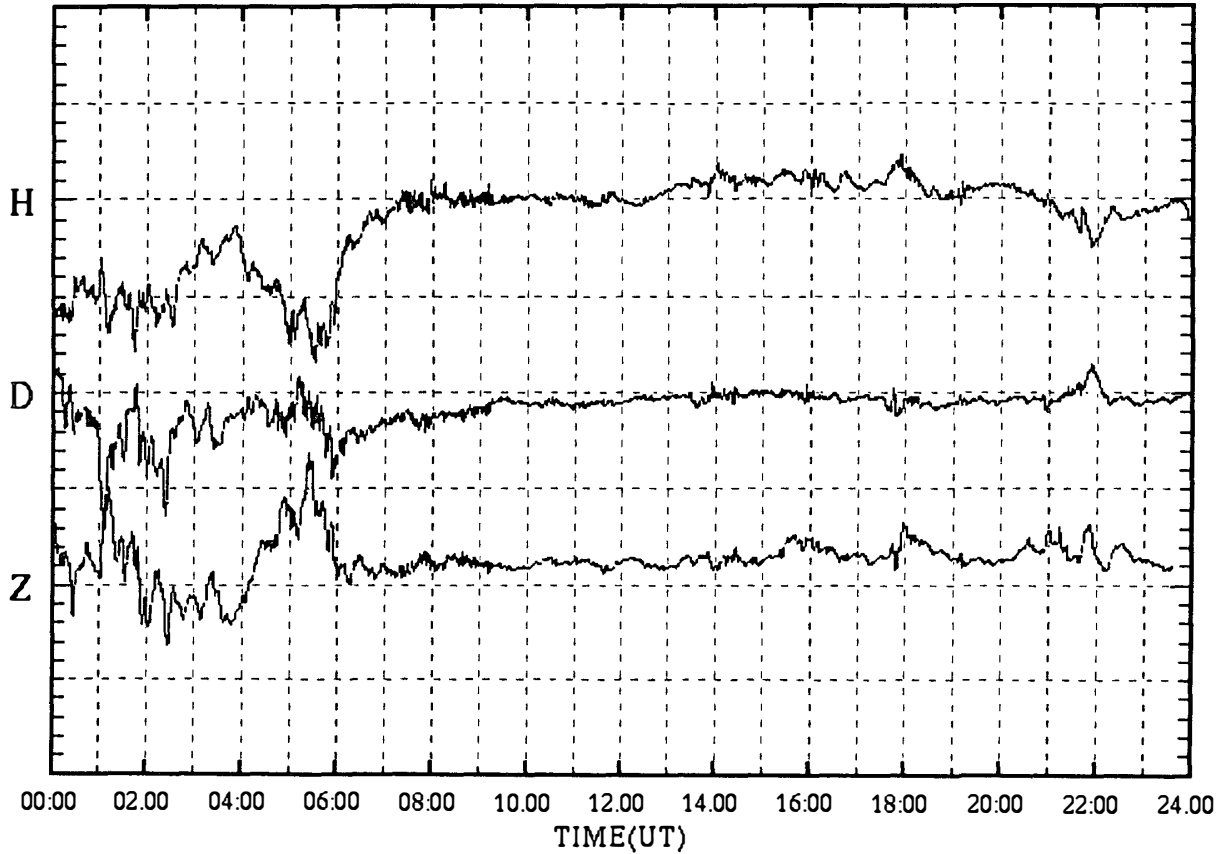



SYOWA magnetogram (100 nT/div)

16 Oct.1999 (DAY:289)

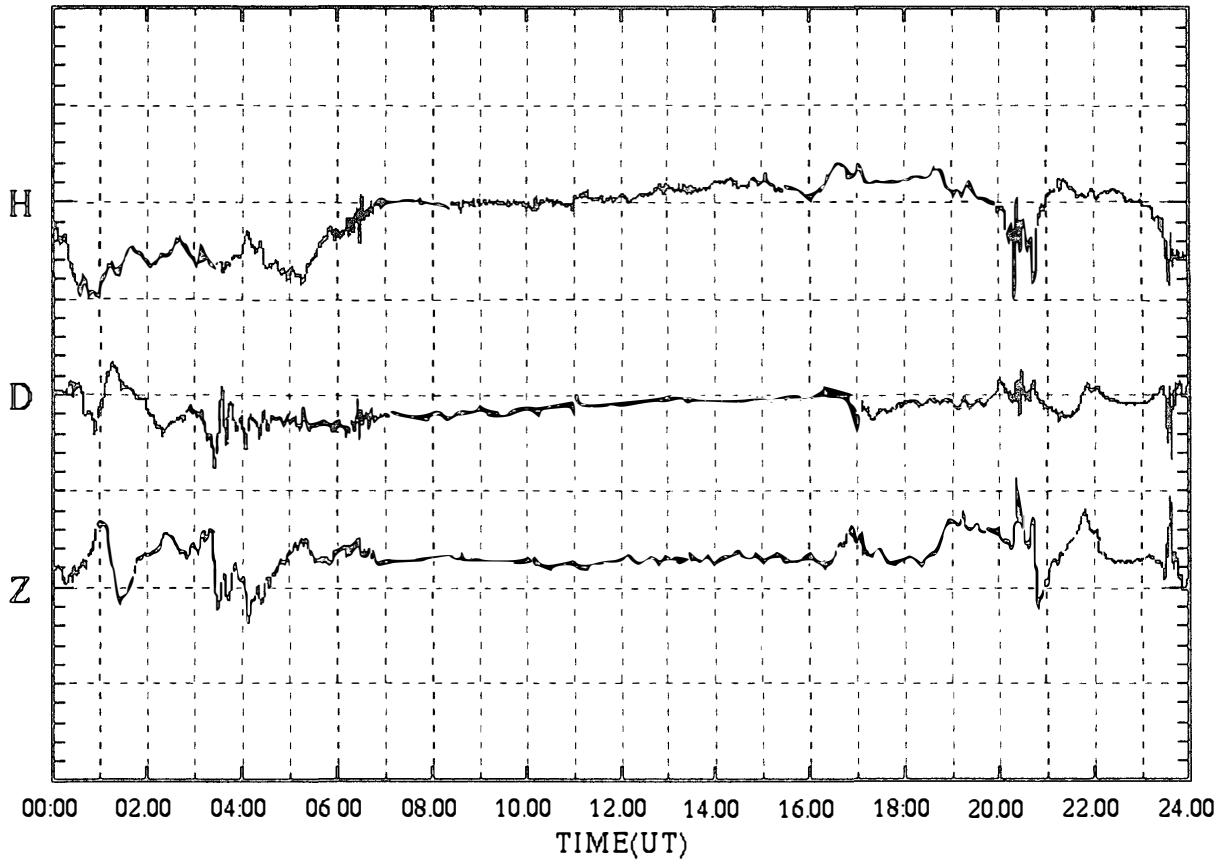

SYOWA magnetogram (100 nT/div)

17 Oct.1999 (DAY:290)

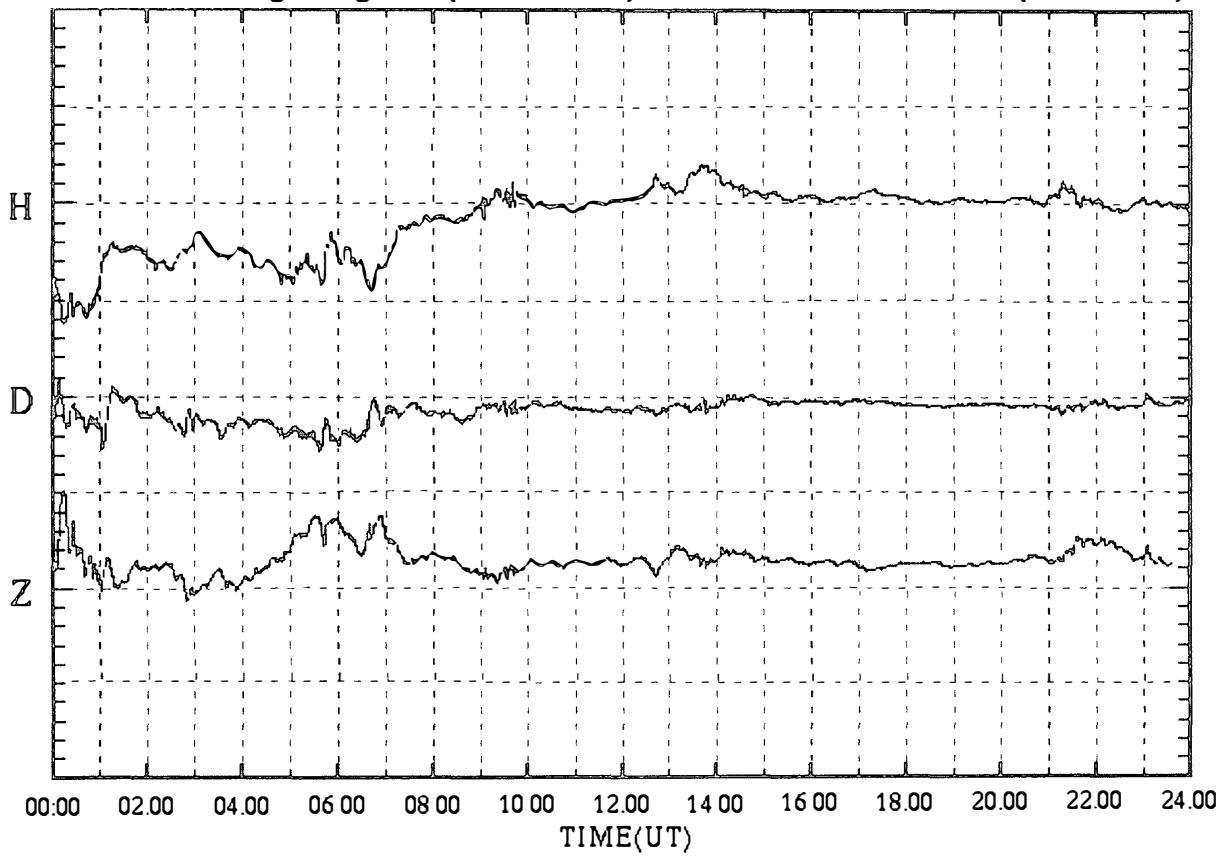

SYOWA magnetogram (100 nT/div)

18 Oct.1999 (DAY:291)

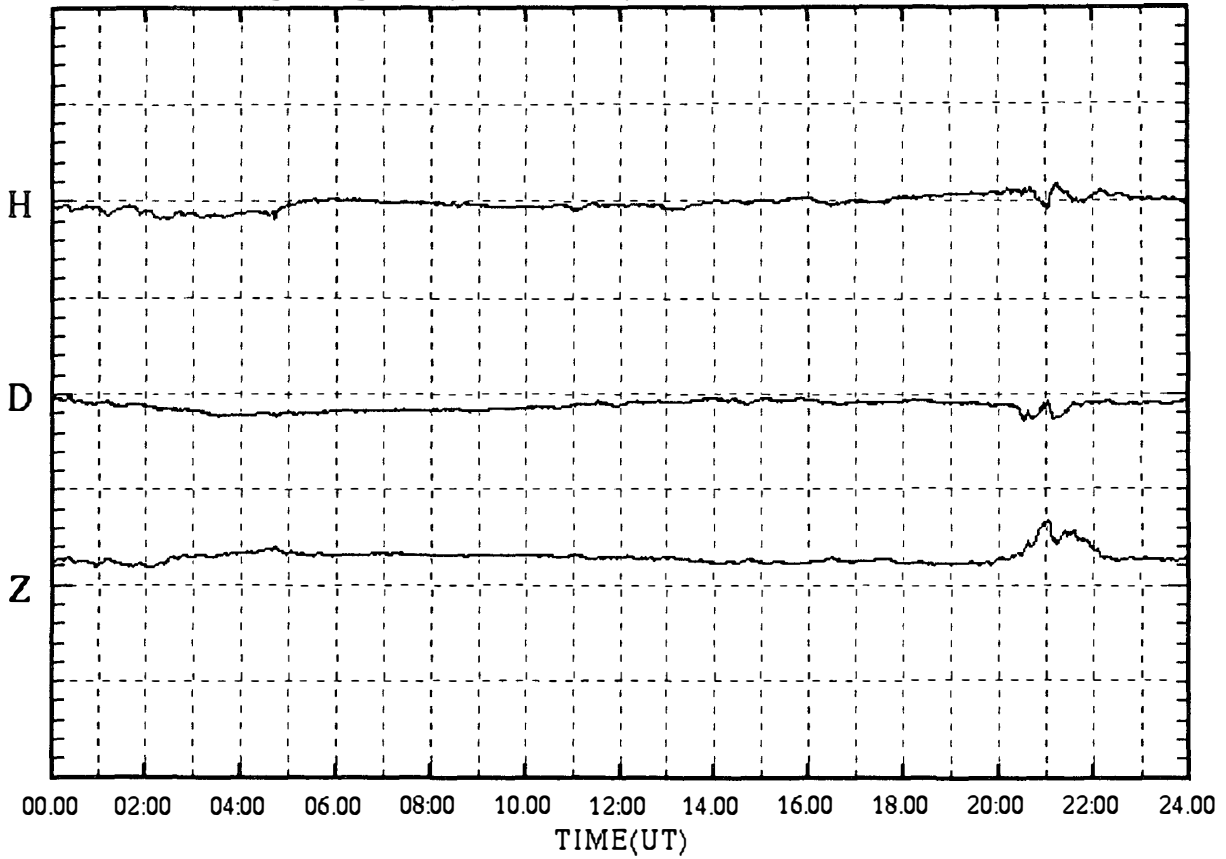

SYOWA magnetogram (100 nT/div)

19 Oct.1999 (DAY:292)

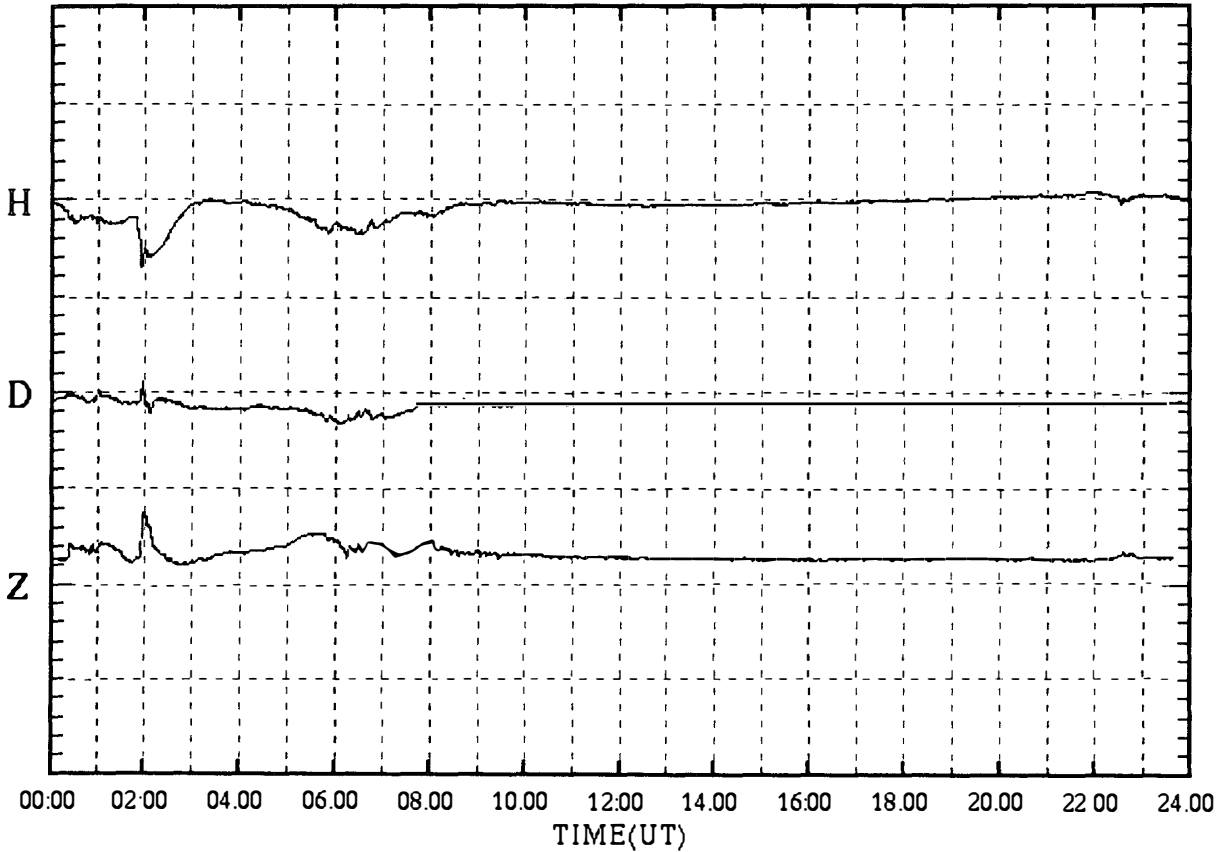

SYOWA magnetogram (100 nT/div)

20 Oct.1999 (DAY:293)

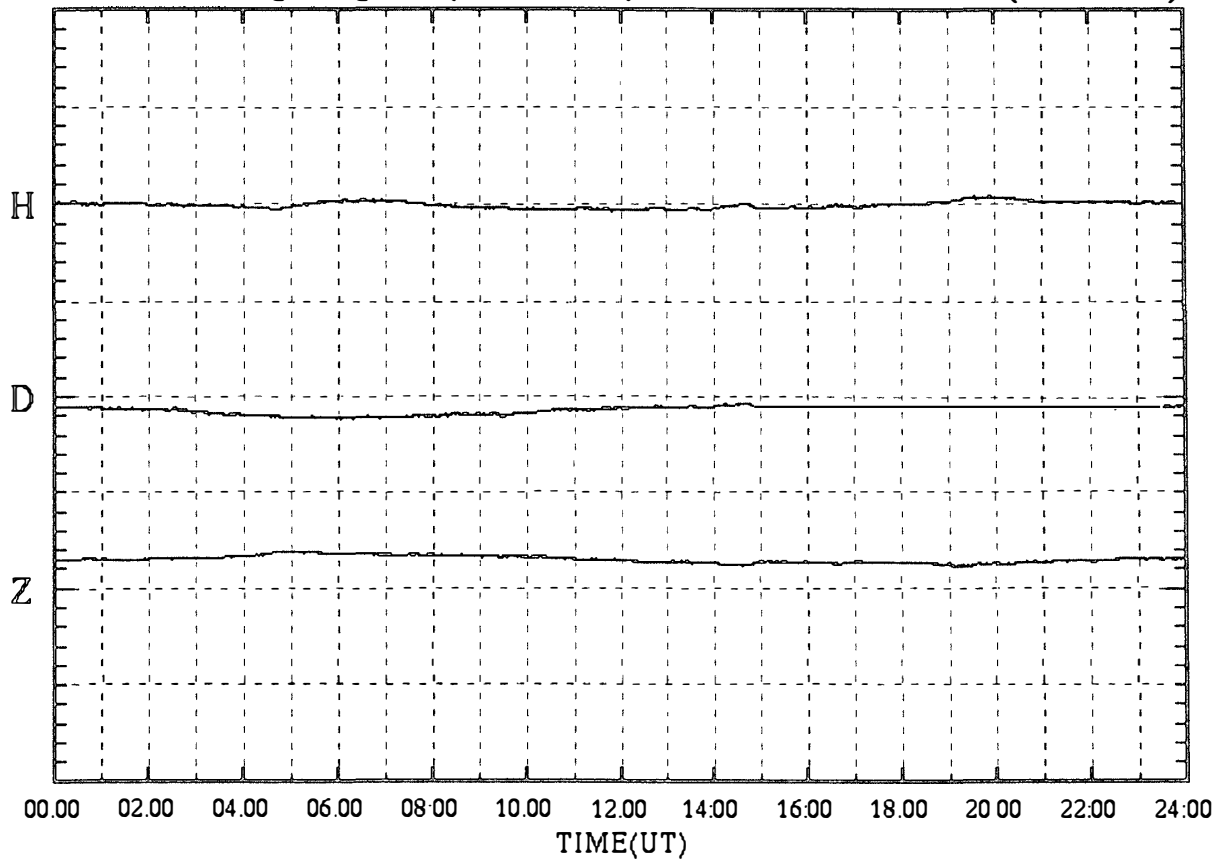

SYOWA magnetogram (100 nT/div)

21 Oct.1999 (DAY:294)

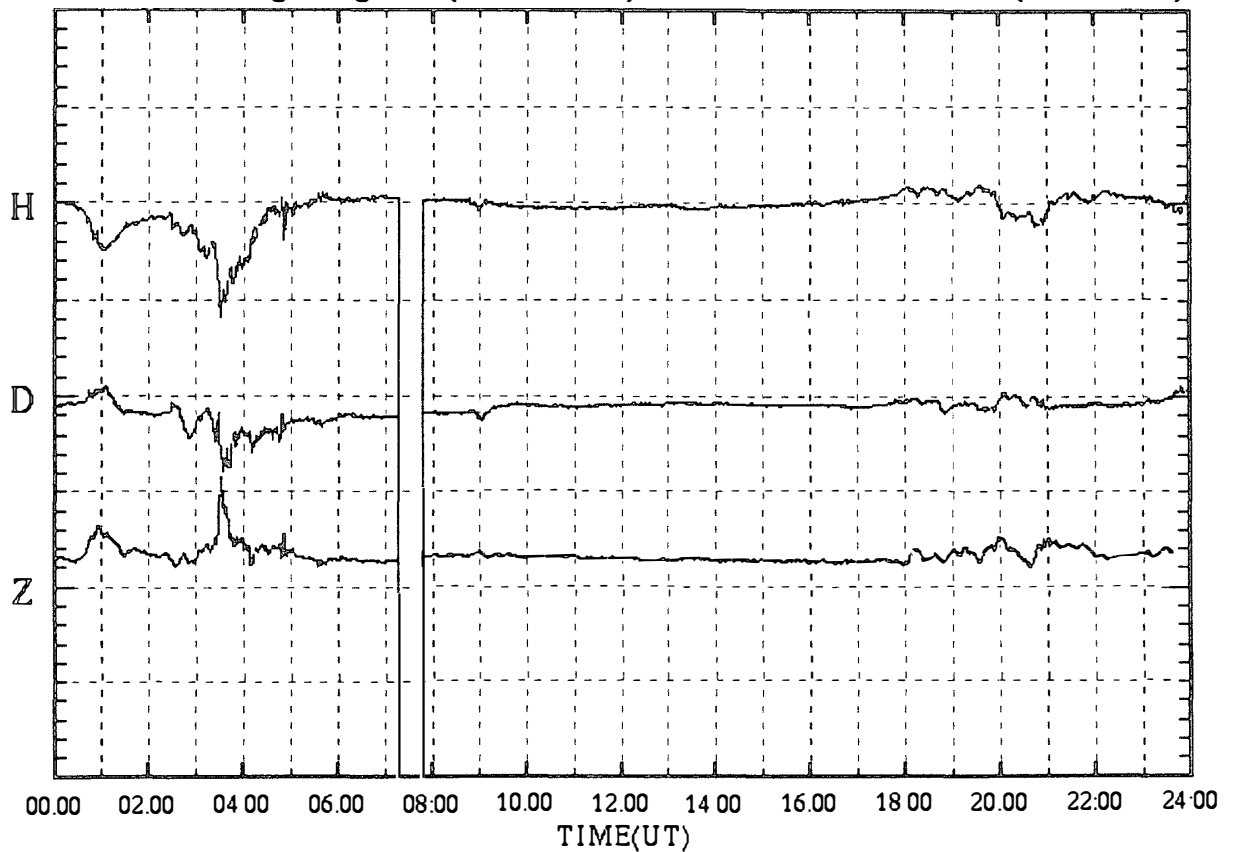

SYOWA magnetogram (100 nT/div)

22 Oct.1999 (DAY:295)

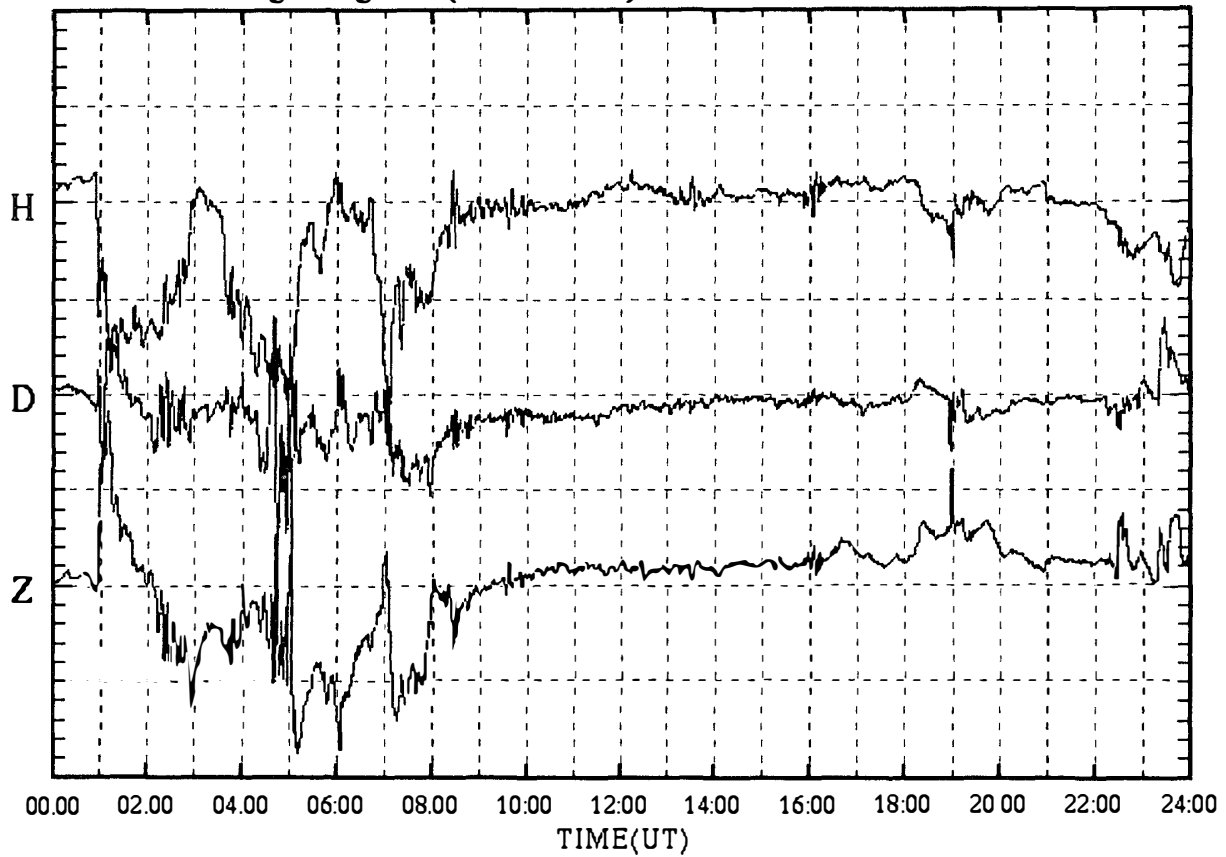

SYOWA magnetogram (100 nT/div)

23 Oct.1999 (DAY:296)

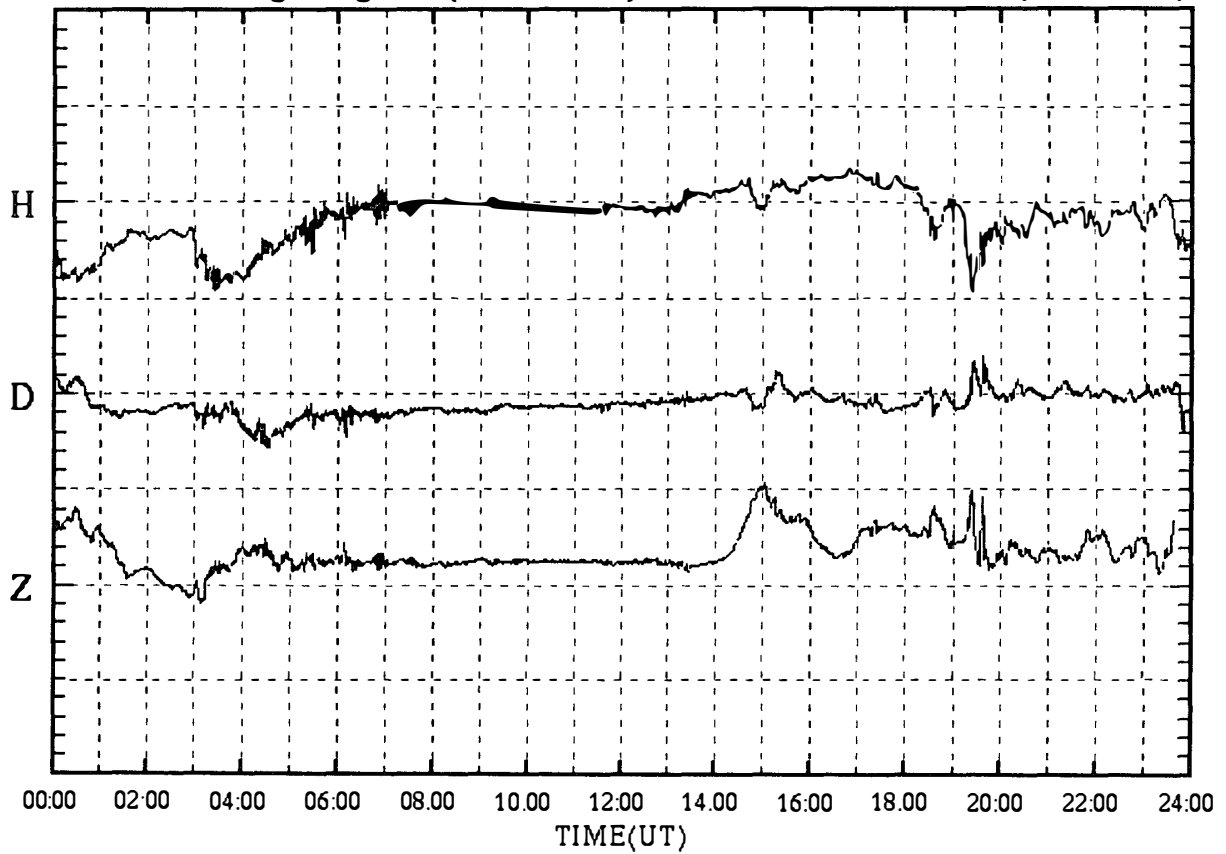

SYOWA magnetogram (100 nT/div)

24 Oct.1999 (DAY:297)

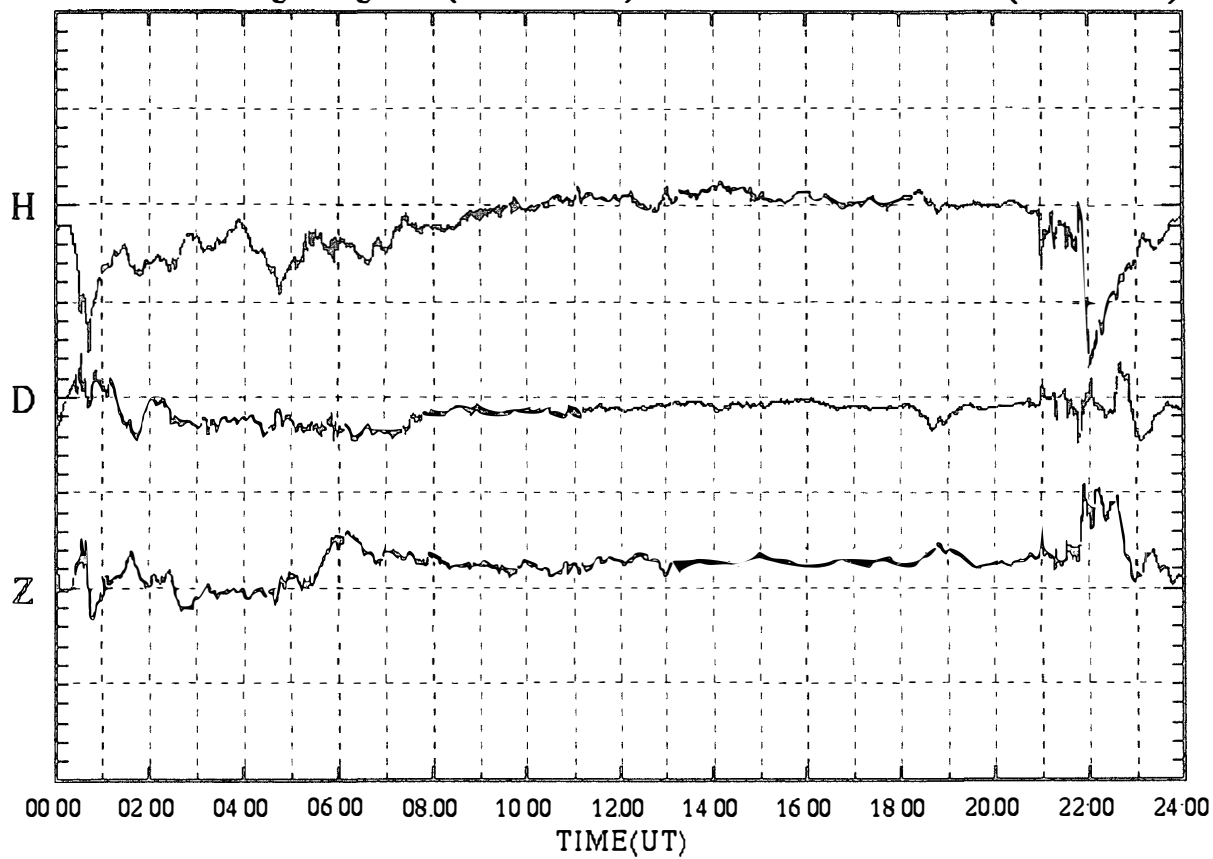

SYOWA magnetogram (100 nT/div)

25 Oct.1999 (DAY:298)

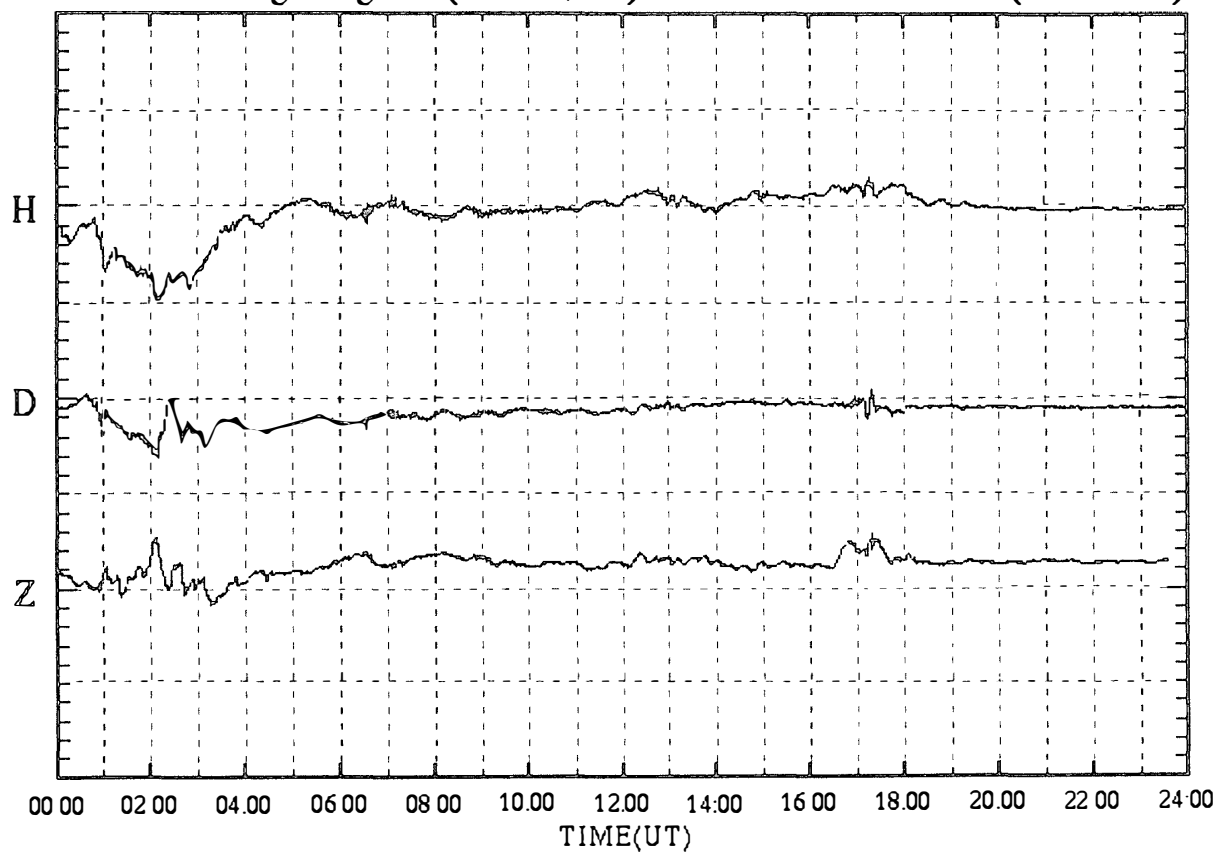

SYOWA magnetogram (100 nT/div)

26 Oct.1999 (DAY:299)

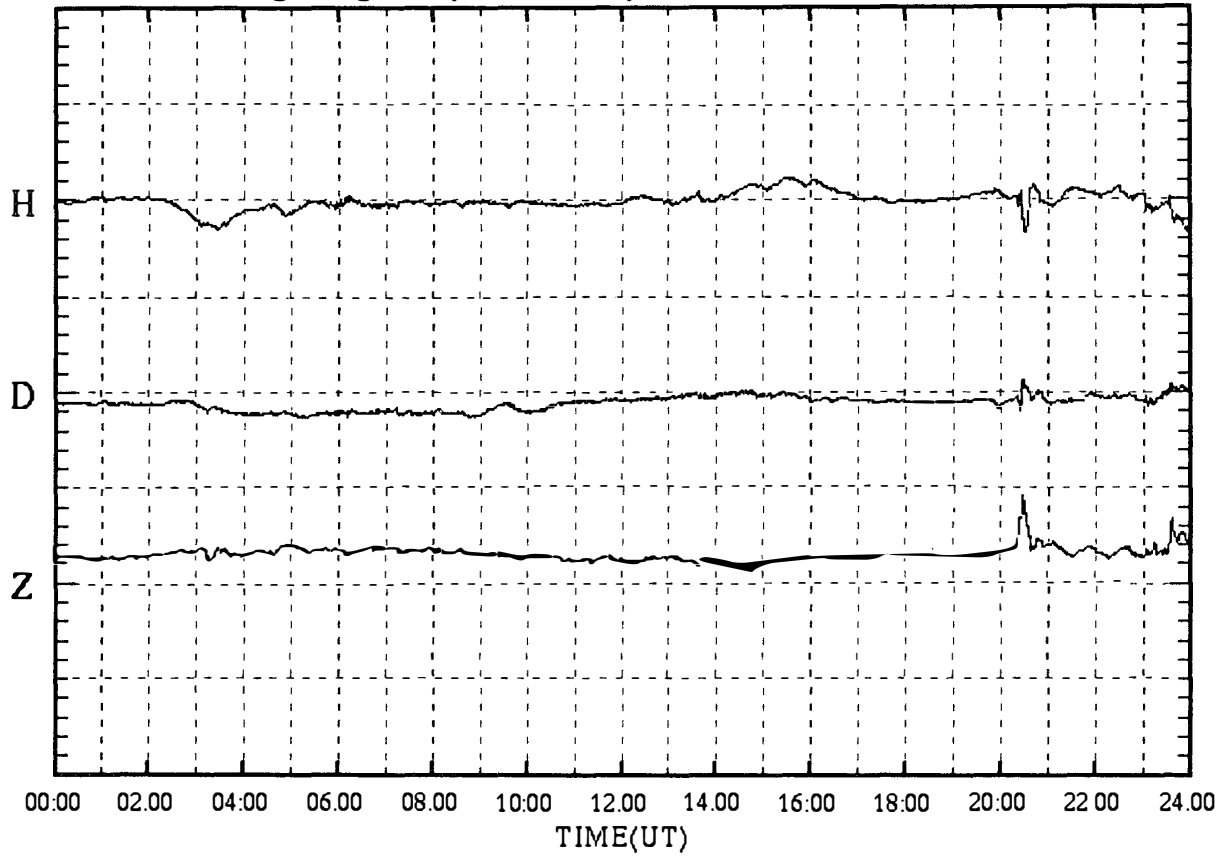

SYOWA magnetogram (100 nT/div)

27 Oct.1999 (DAY:300)

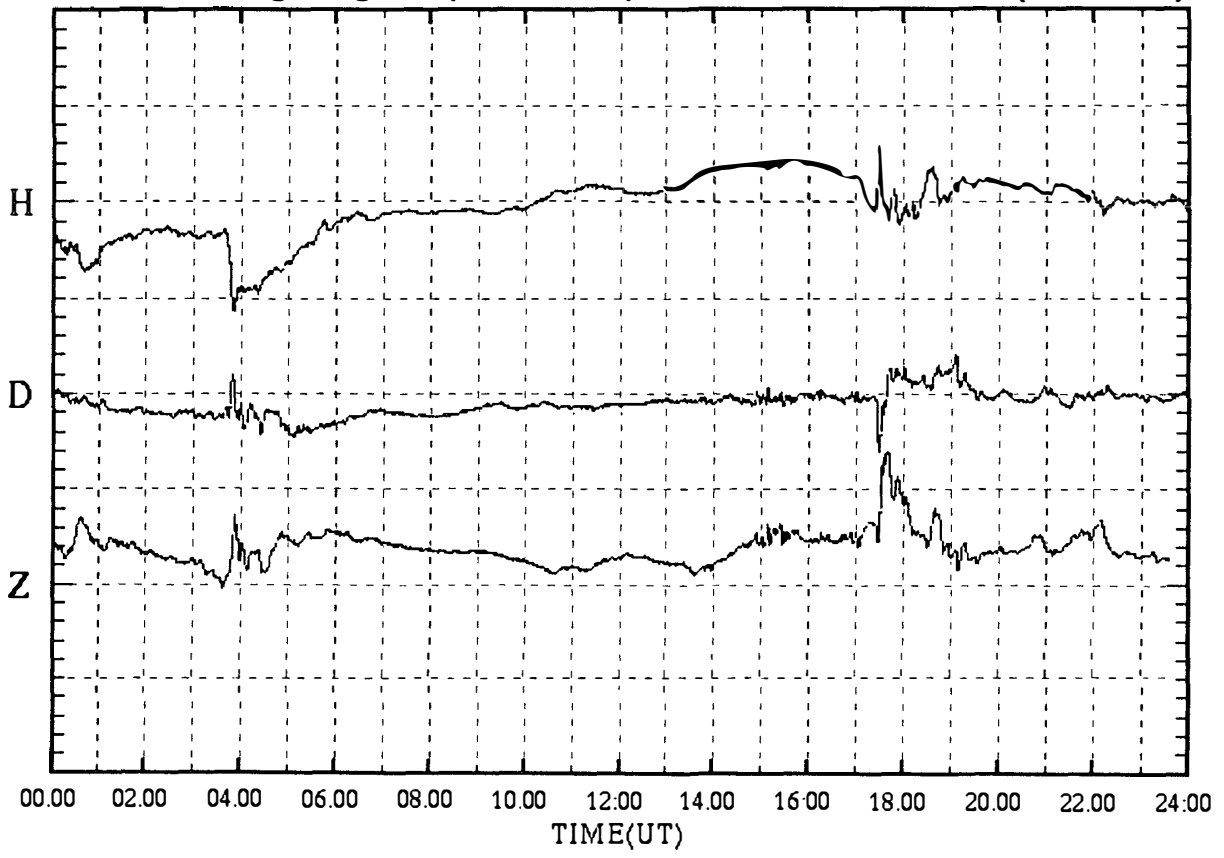

SYOWA magnetogram (100 nT/div)

28 Oct.1999 (DAY:301)

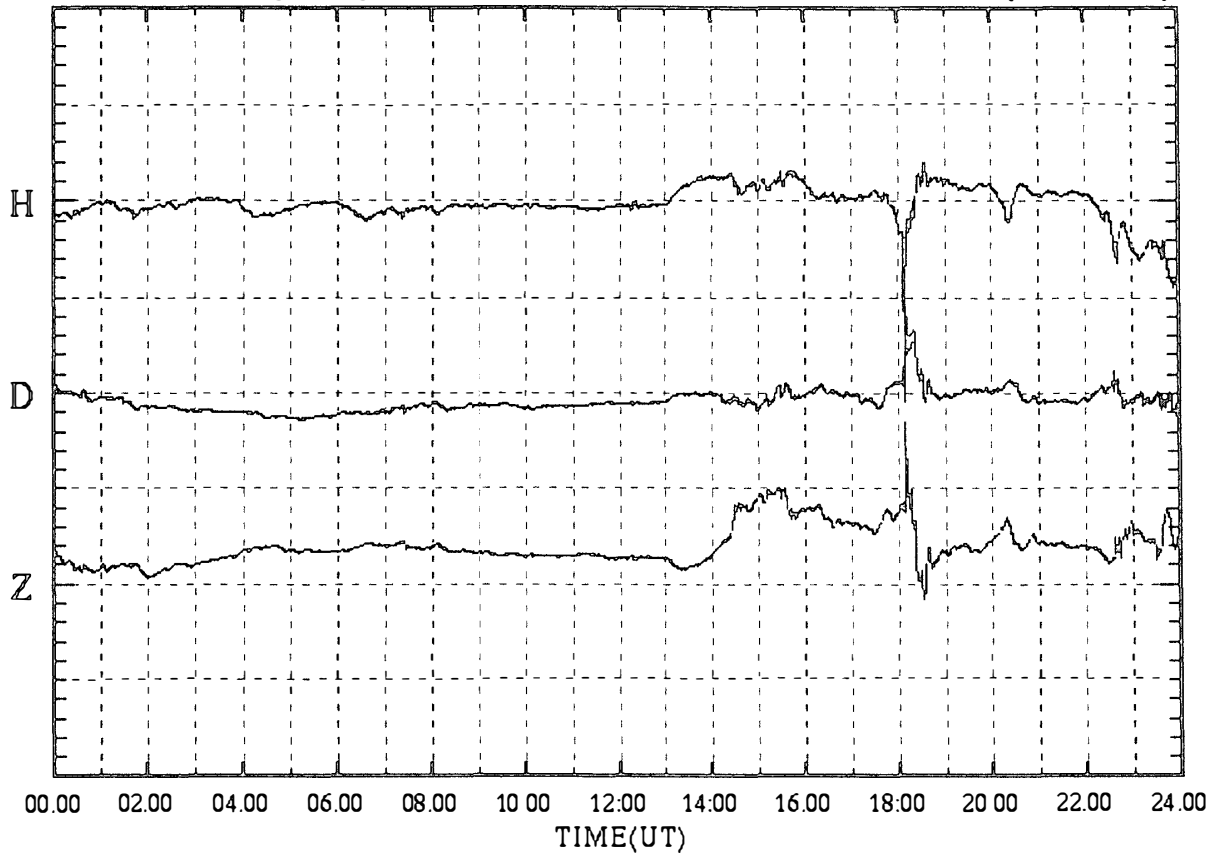

SYOWA magnetogram (100 nT/div)

29 Oct.1999 (DAY:302)

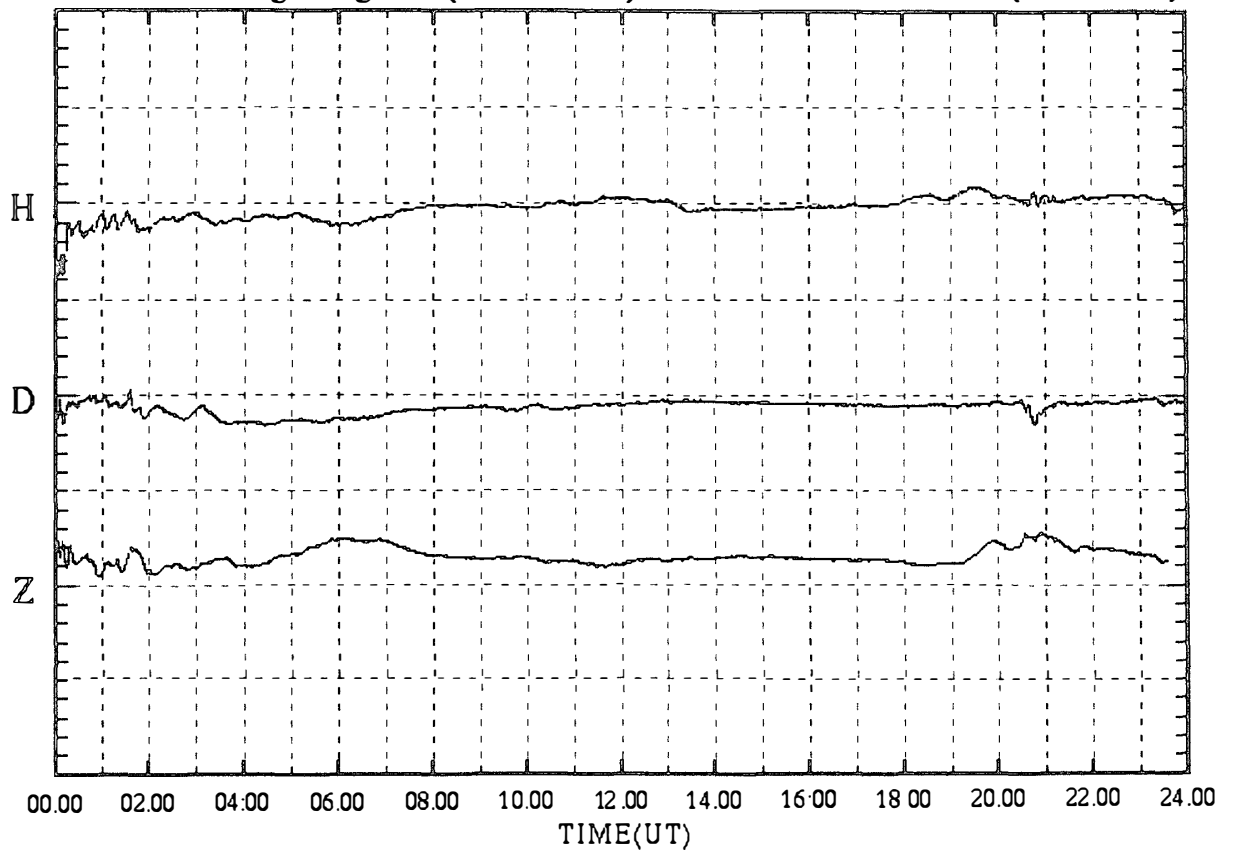

SYOWA magnetogram (100 nT/div)

30 Oct.1999 (DAY:303)

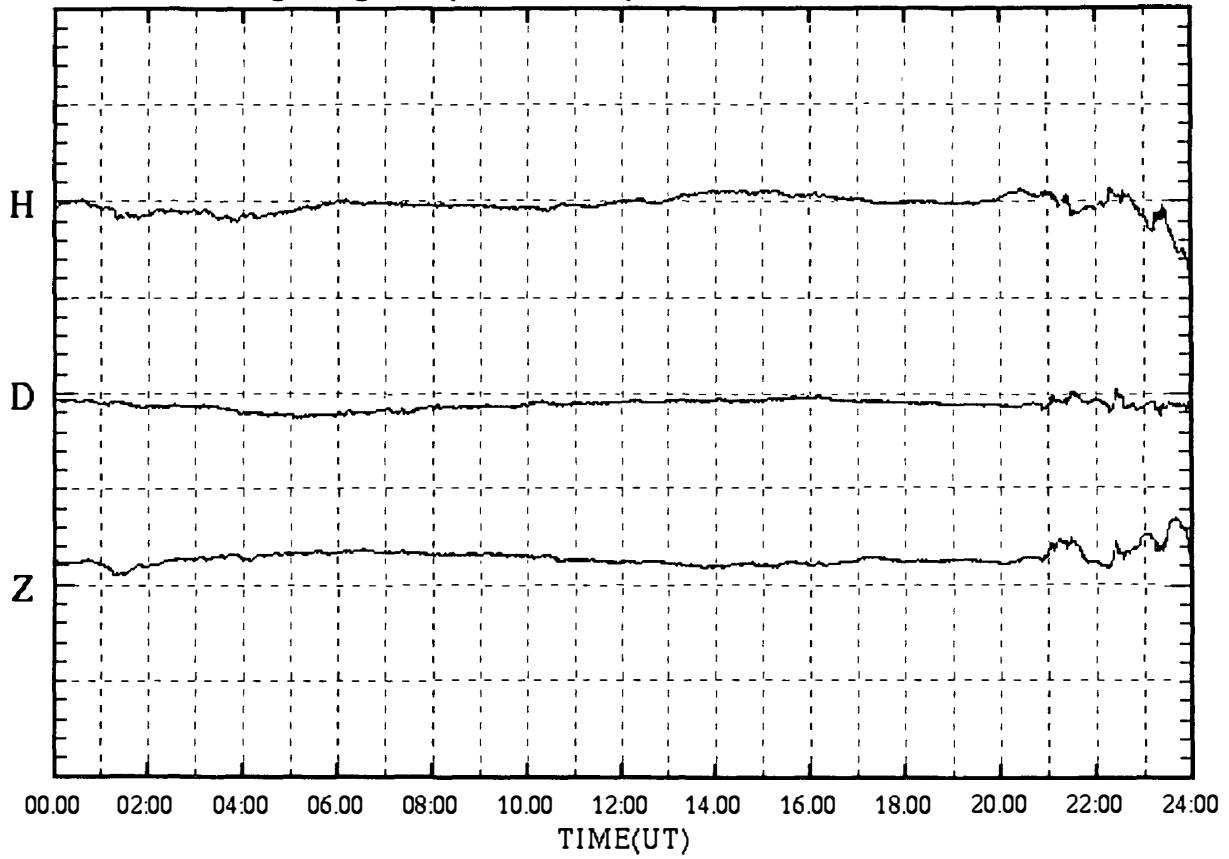

SYOWA magnetogram (100 nT/div)

31 Oct.1999 (DAY:304)

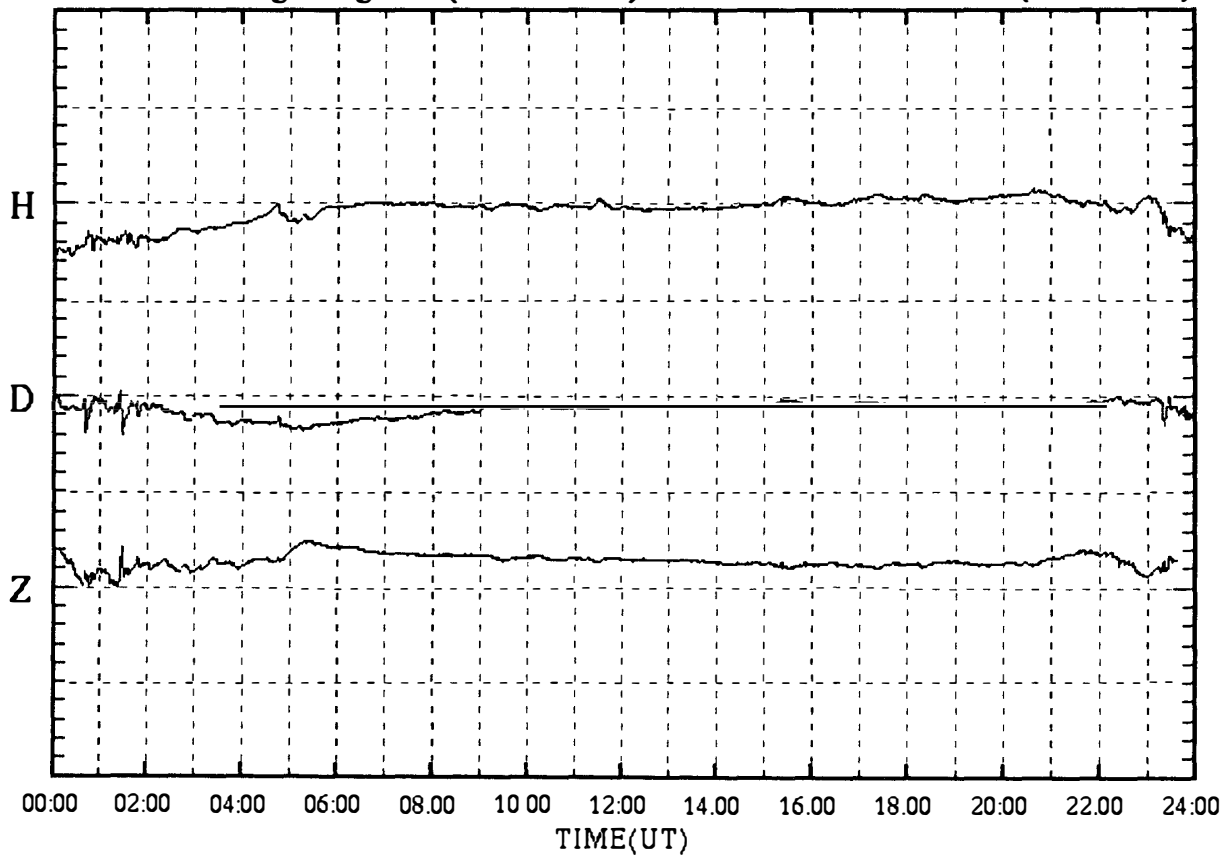



SYOWA magnetogram (100 nT/div)

01 Nov.1999 (DAY:305)

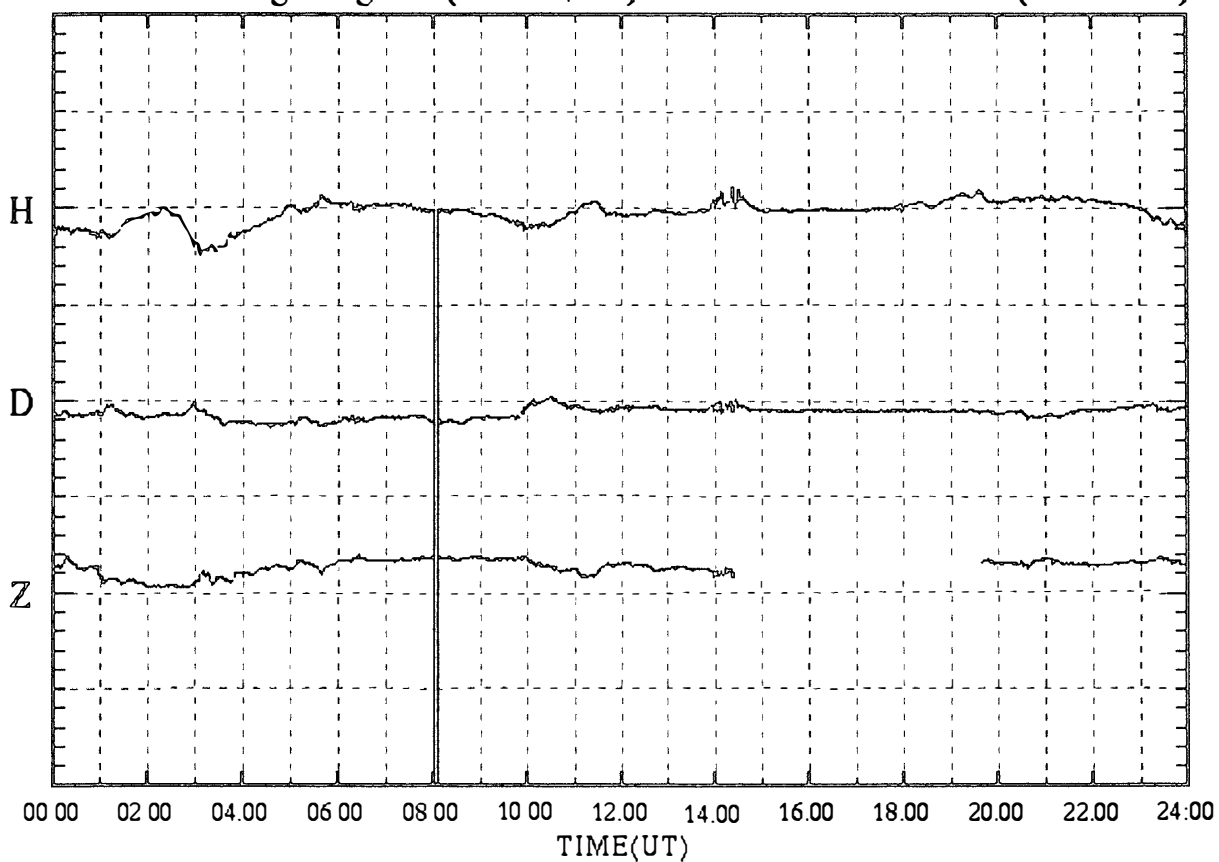

SYOWA magnetogram (100 nT/div)

02 Nov.1999 (DAY:306)

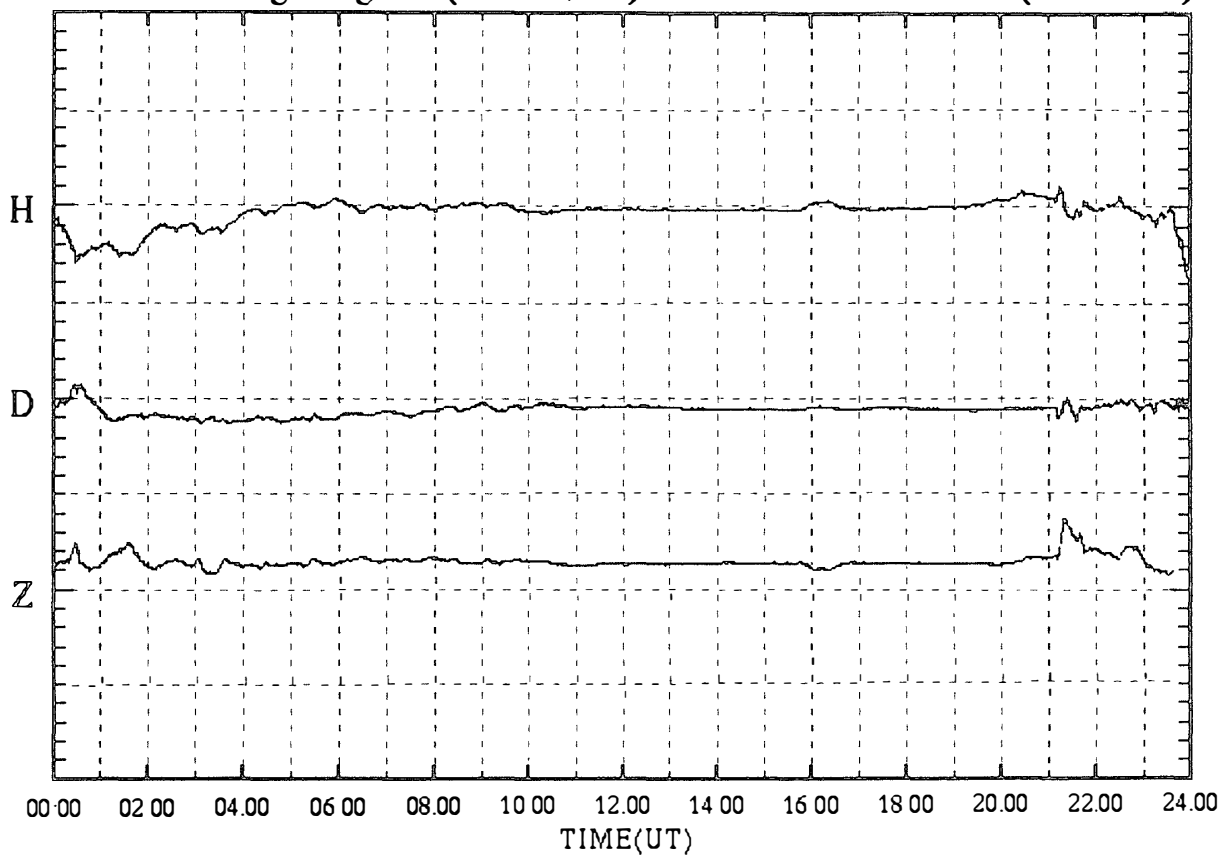

SYOWA magnetogram (100 nT/div)

03 Nov.1999 (DAY:307)

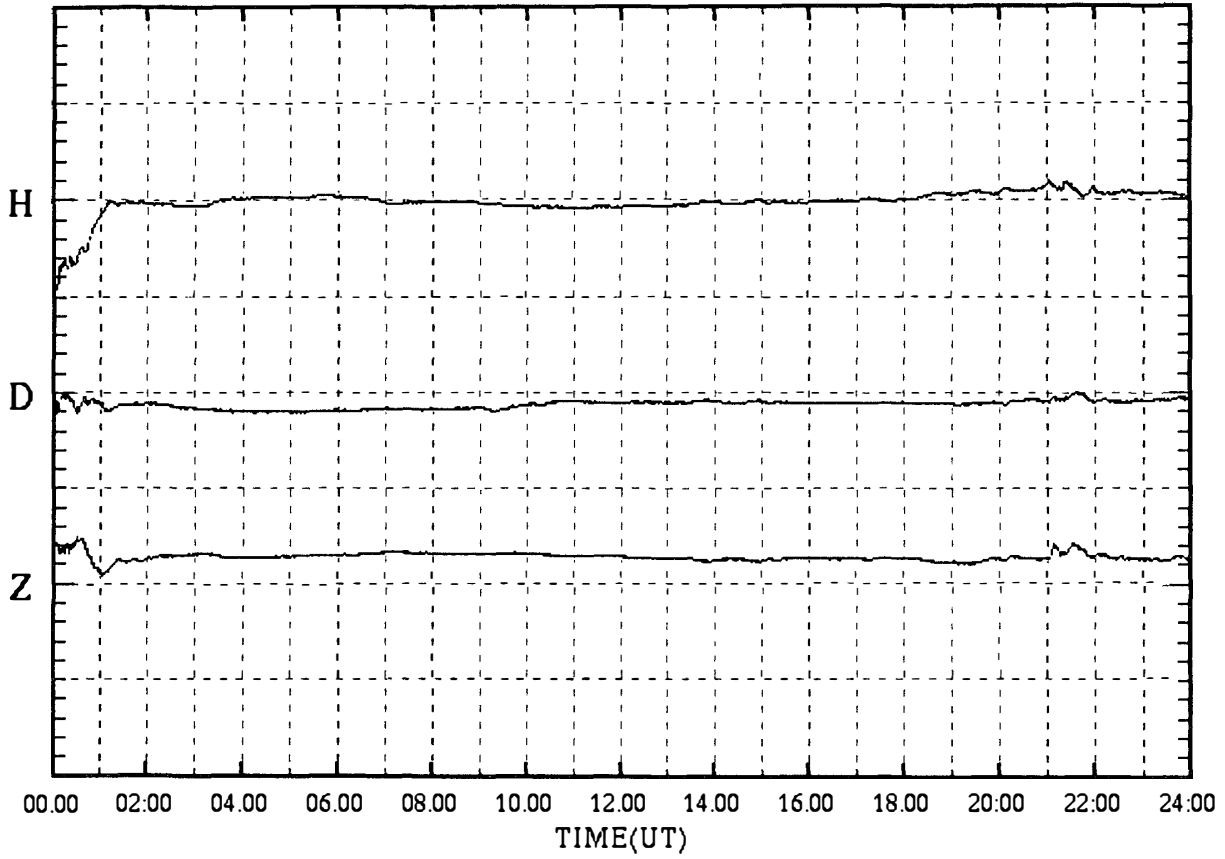

SYOWA magnetogram (100 nT/div)

04 Nov.1999 (DAY:308)

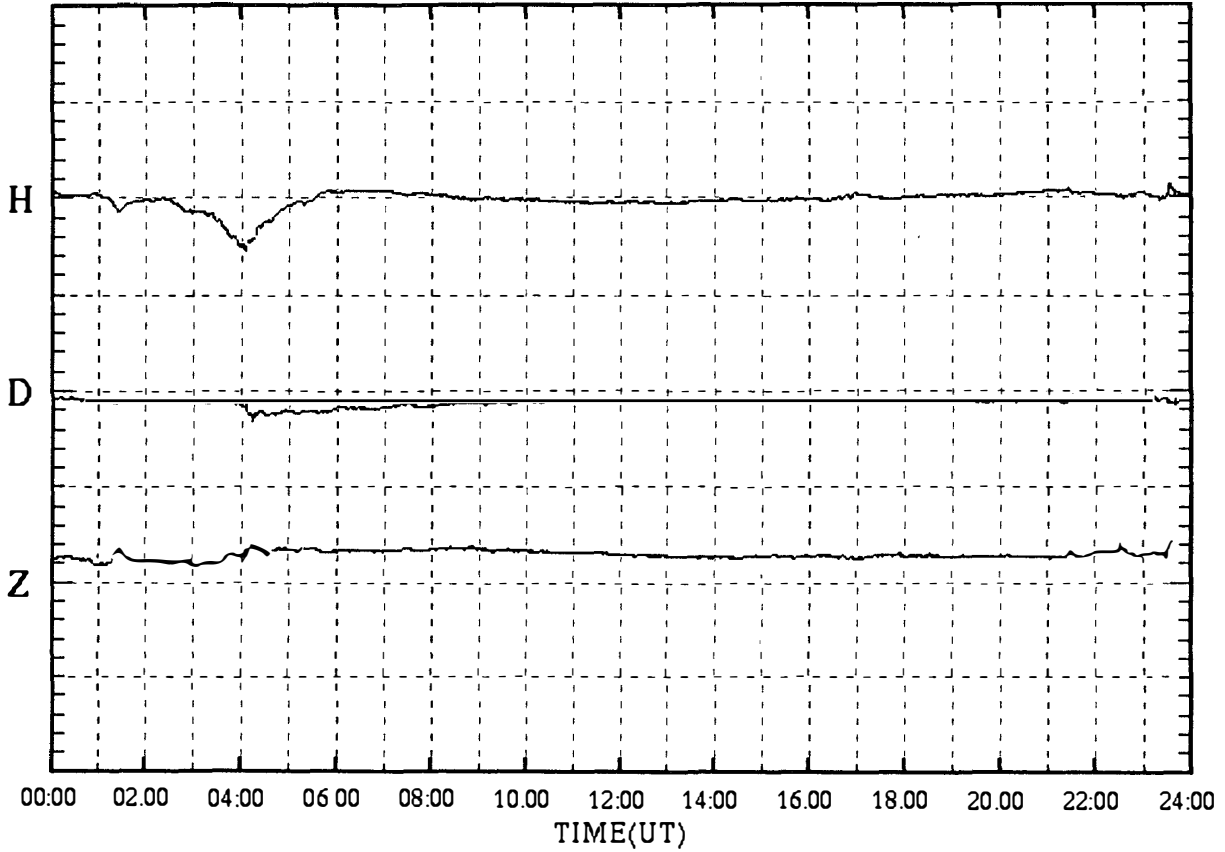

SYOWA magnetogram (100 nT/div)

05 Nov.1999 (DAY:309)

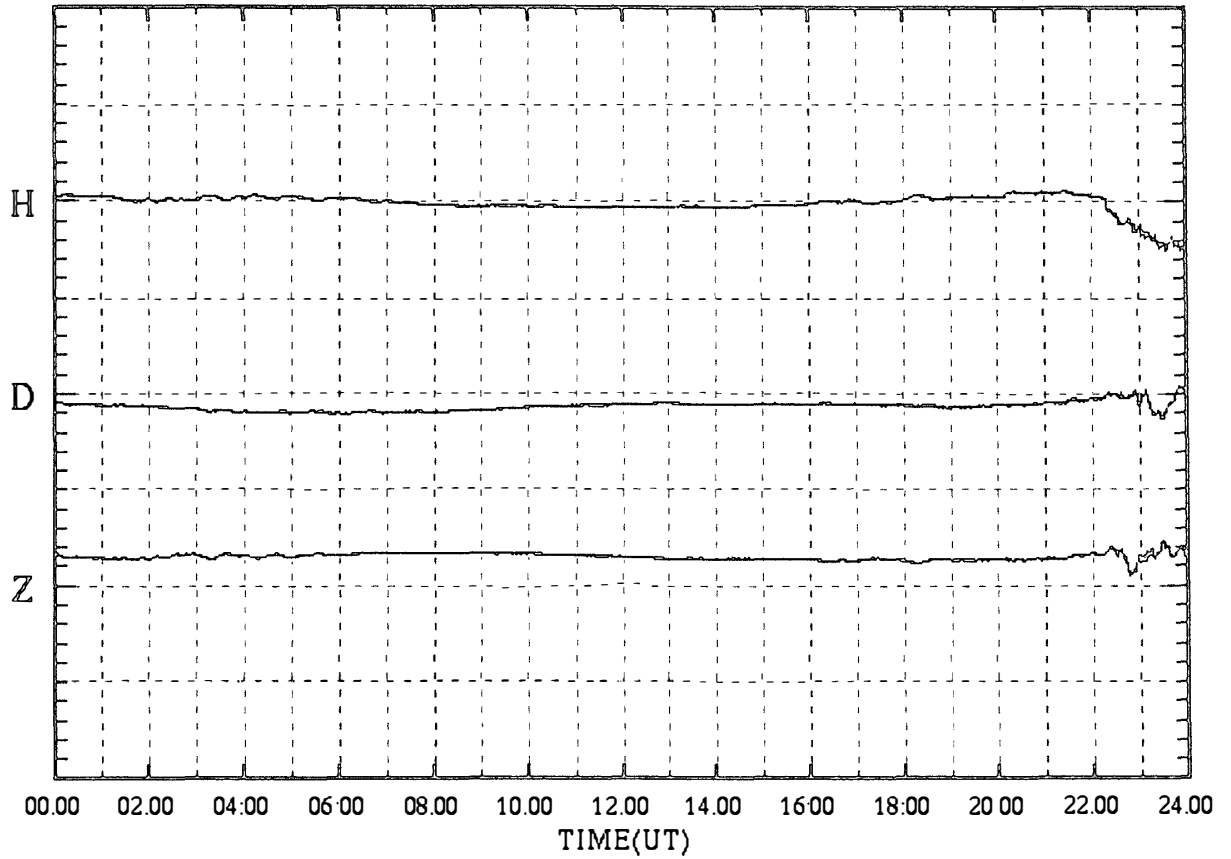

SYOWA magnetogram (100 nT/div)

06 Nov.1999 (DAY:310)

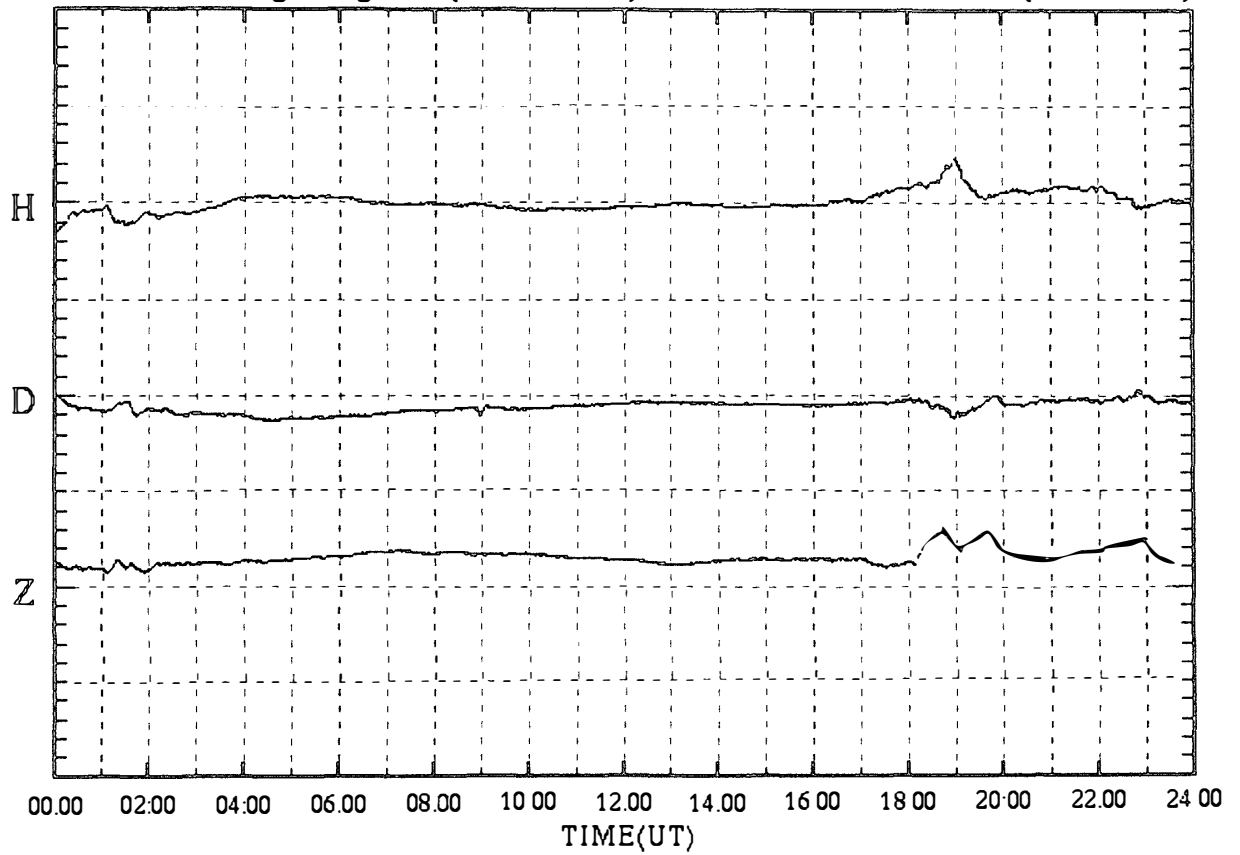

SYOWA magnetogram (100 nT/div)

07 Nov.1999 (DAY:311)

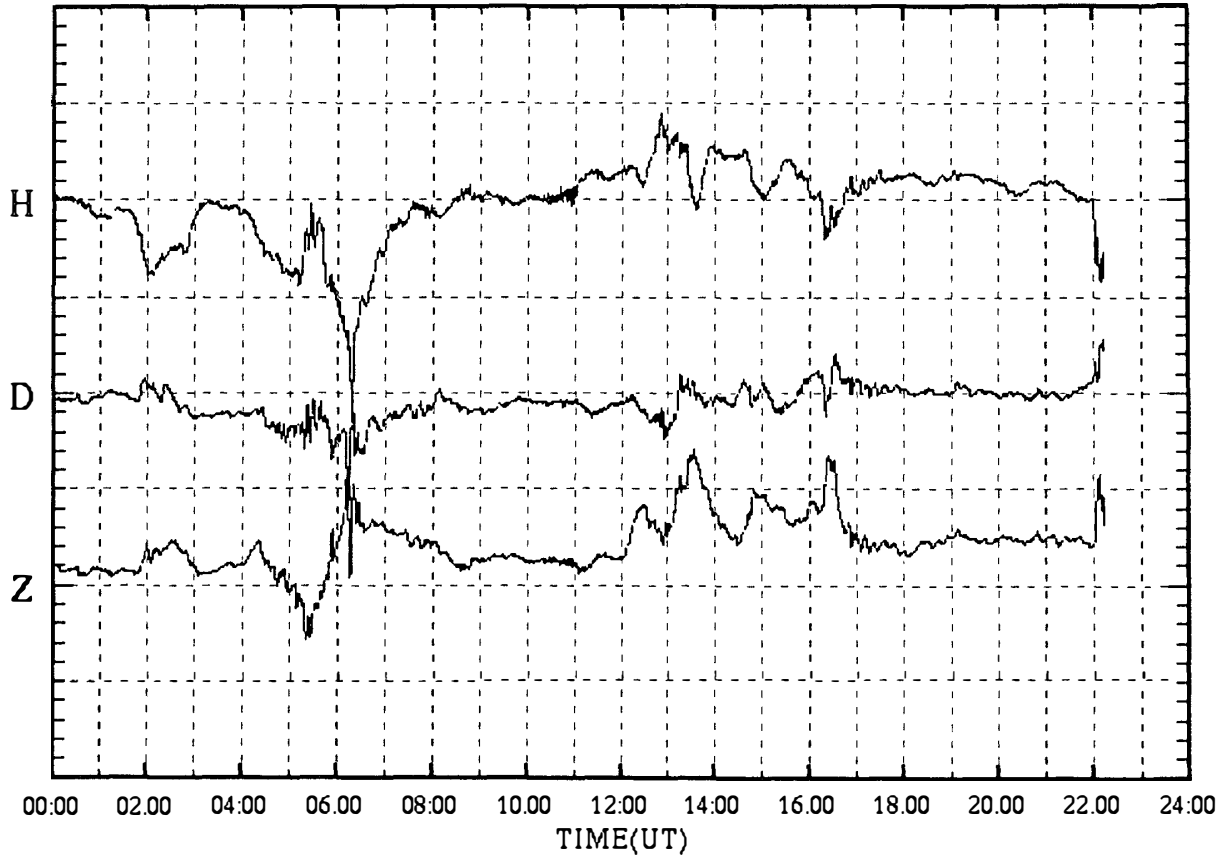

SYOWA magnetogram (100 nT/div)

08 Nov.1999 (DAY:312)

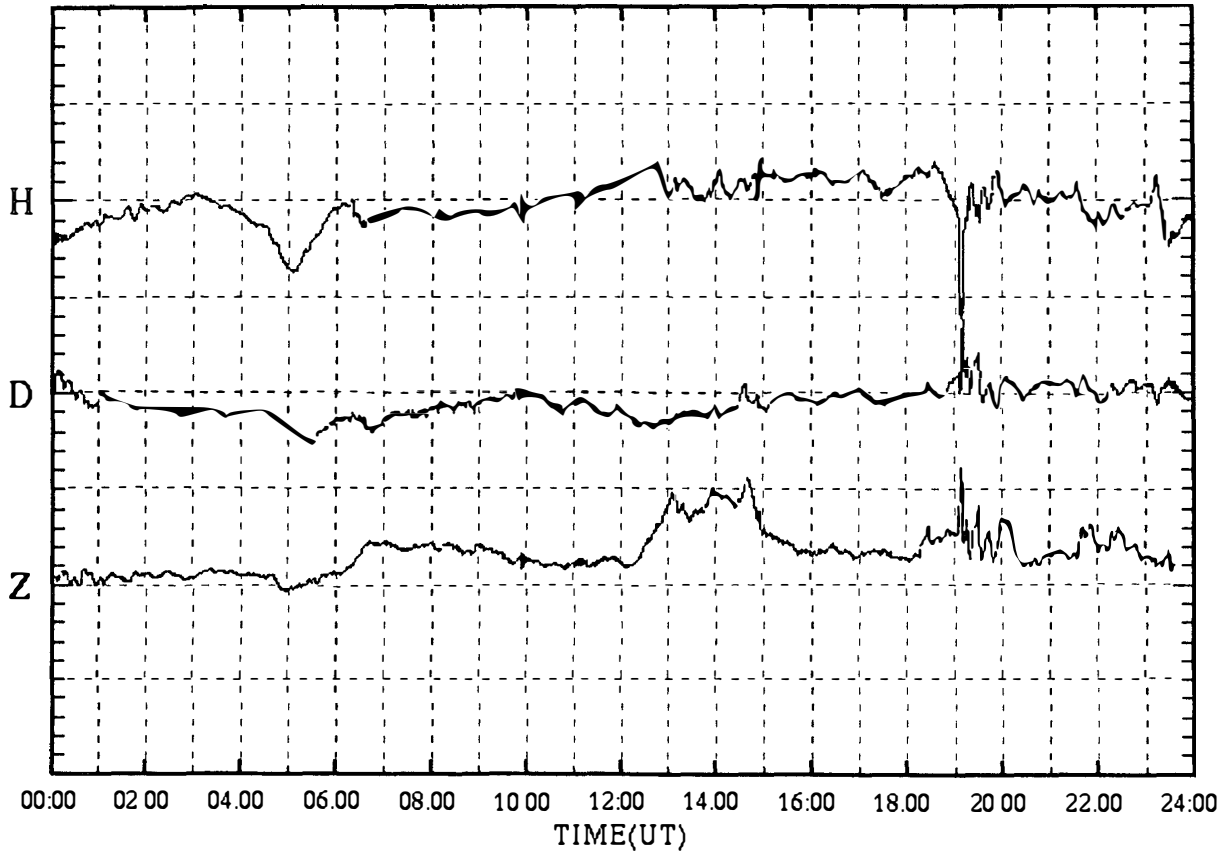

SYOWA magnetogram (100 nT/div)

09 Nov.1999 (DAY:313)

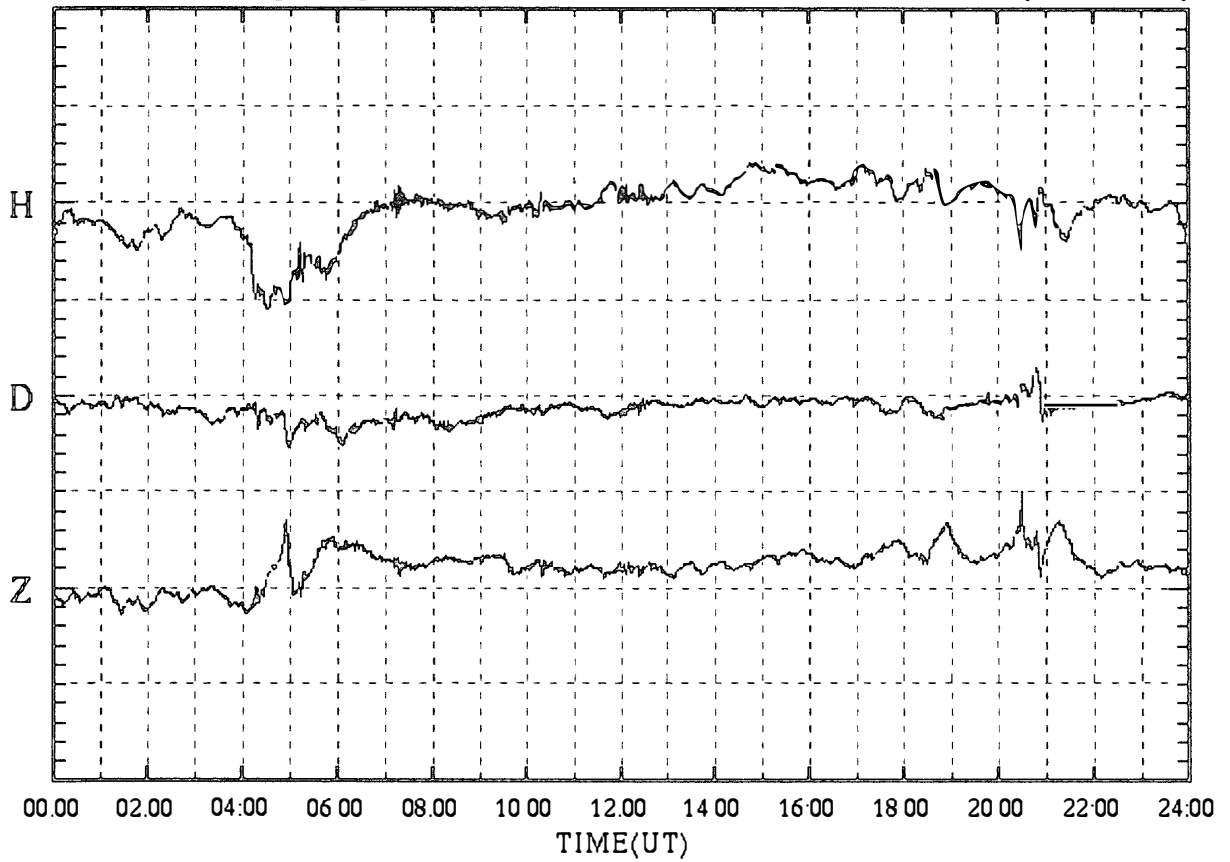

SYOWA magnetogram (100 nT/div)

10 Nov.1999 (DAY:314)

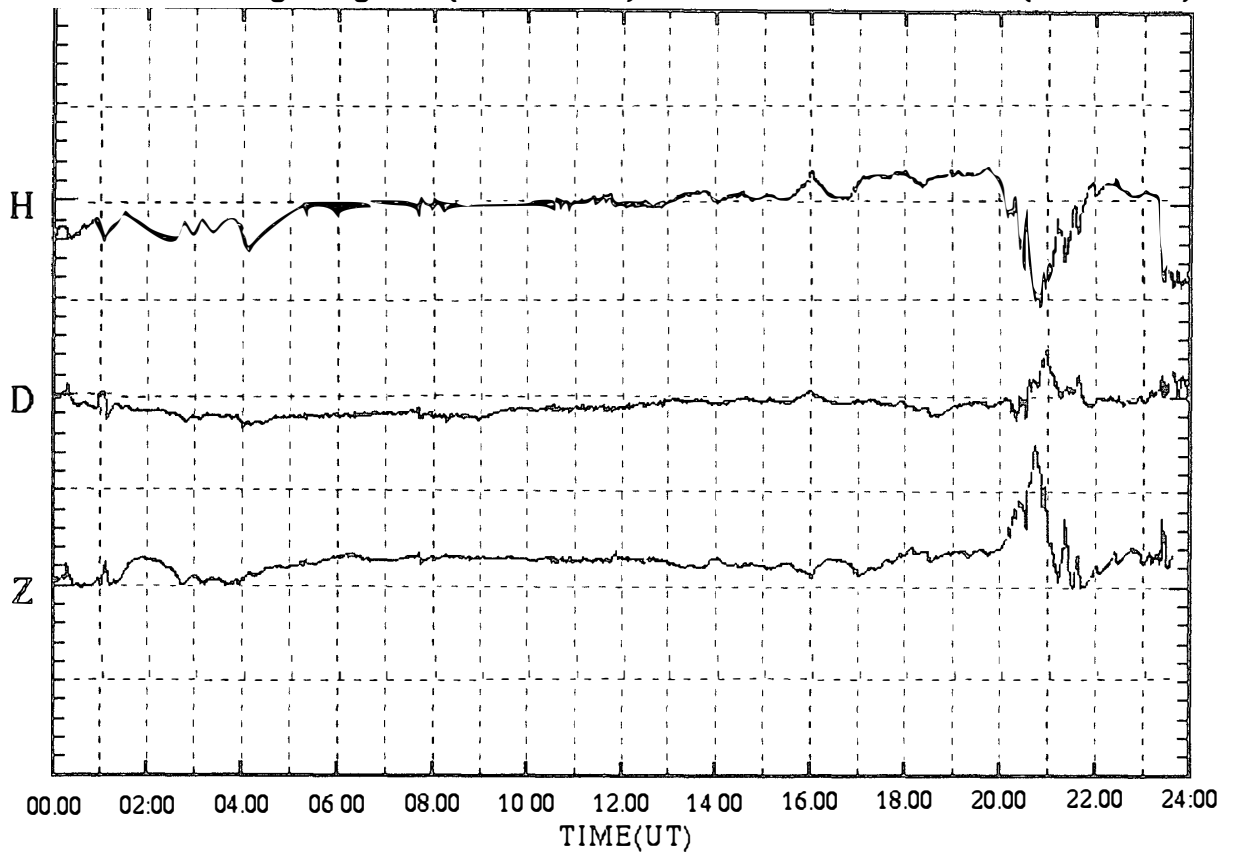

SYOWA magnetogram (100 nT/div)

11 Nov.1999 (DAY:315)

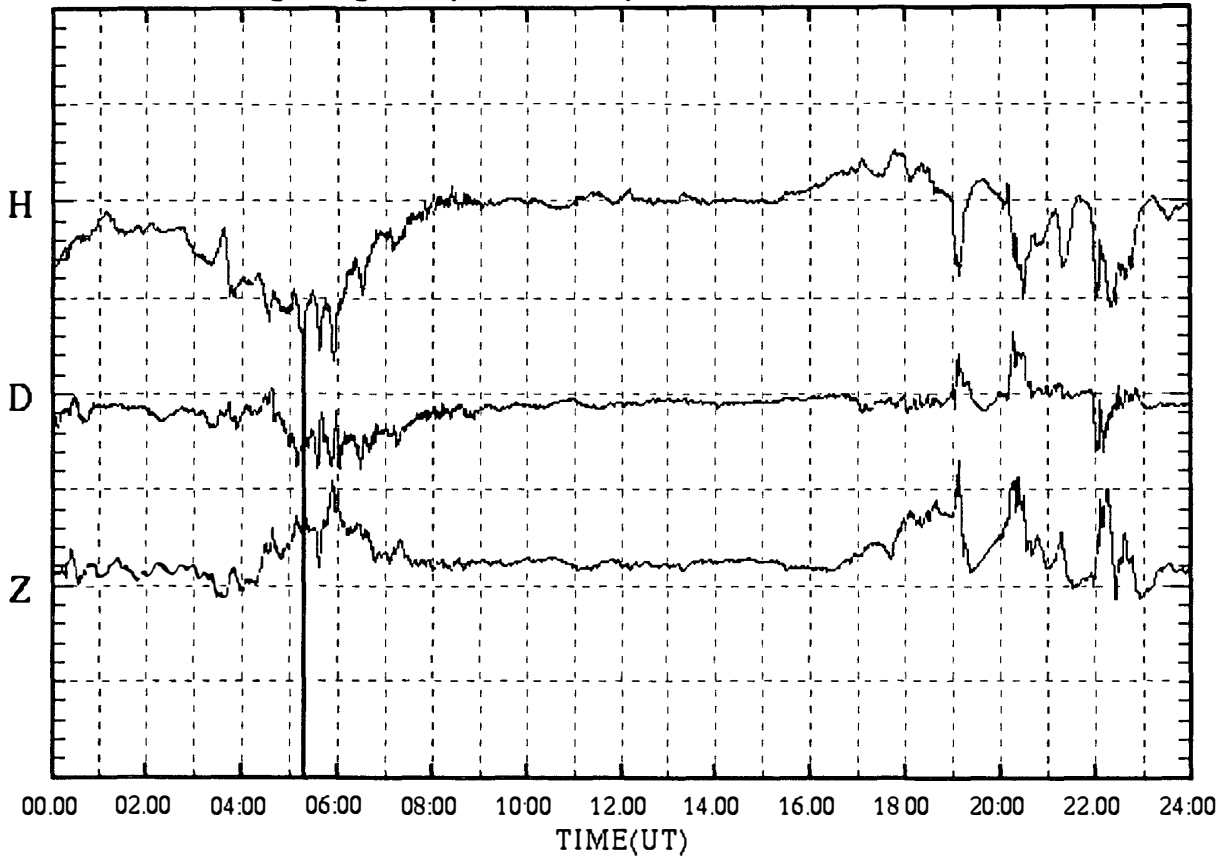

SYOWA magnetogram (100 nT/div)

12 Nov.1999 (DAY:316)

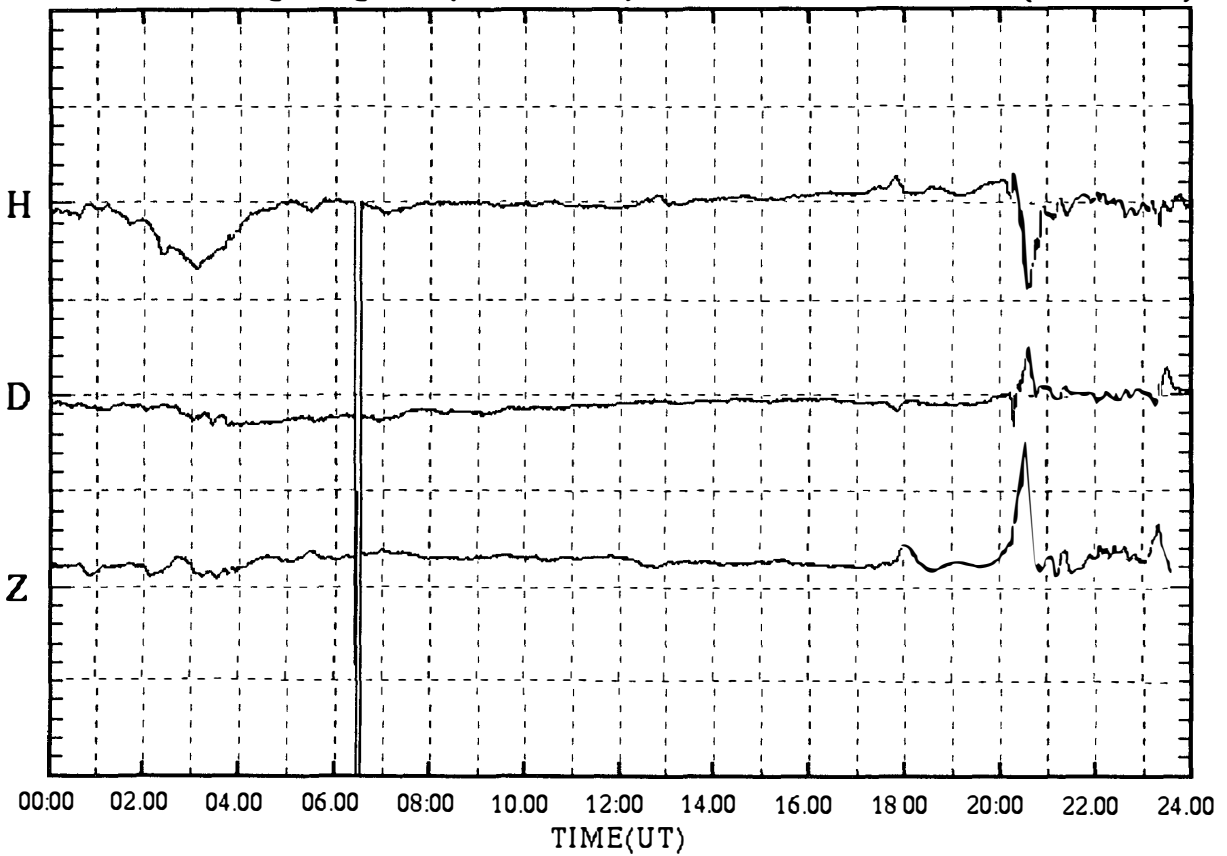

SYOWA magnetogram (100 nT/div)

13 Nov.1999 (DAY:317)

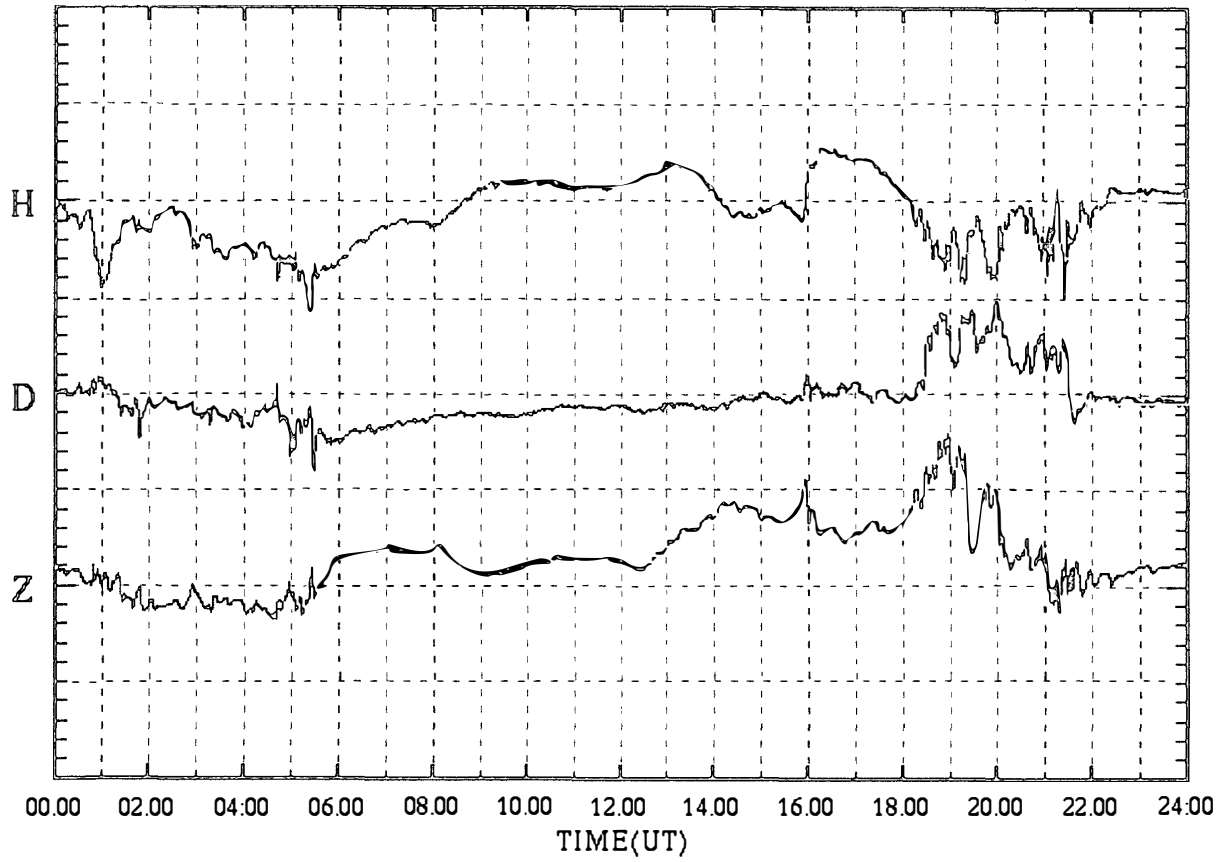

SYOWA magnetogram (100 nT/div)

14 Nov.1999 (DAY:318)

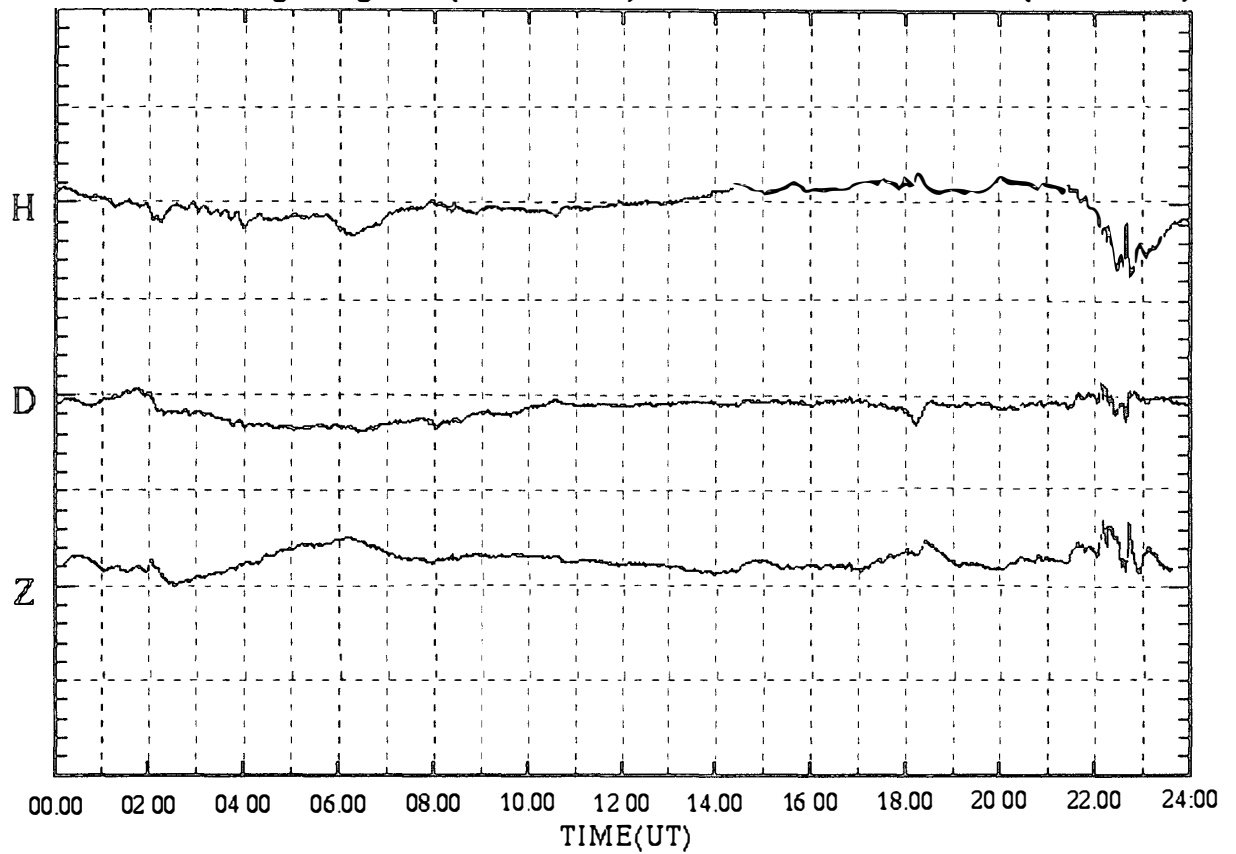

SYOWA magnetogram (100 nT/div)

15 Nov.1999 (DAY:319)

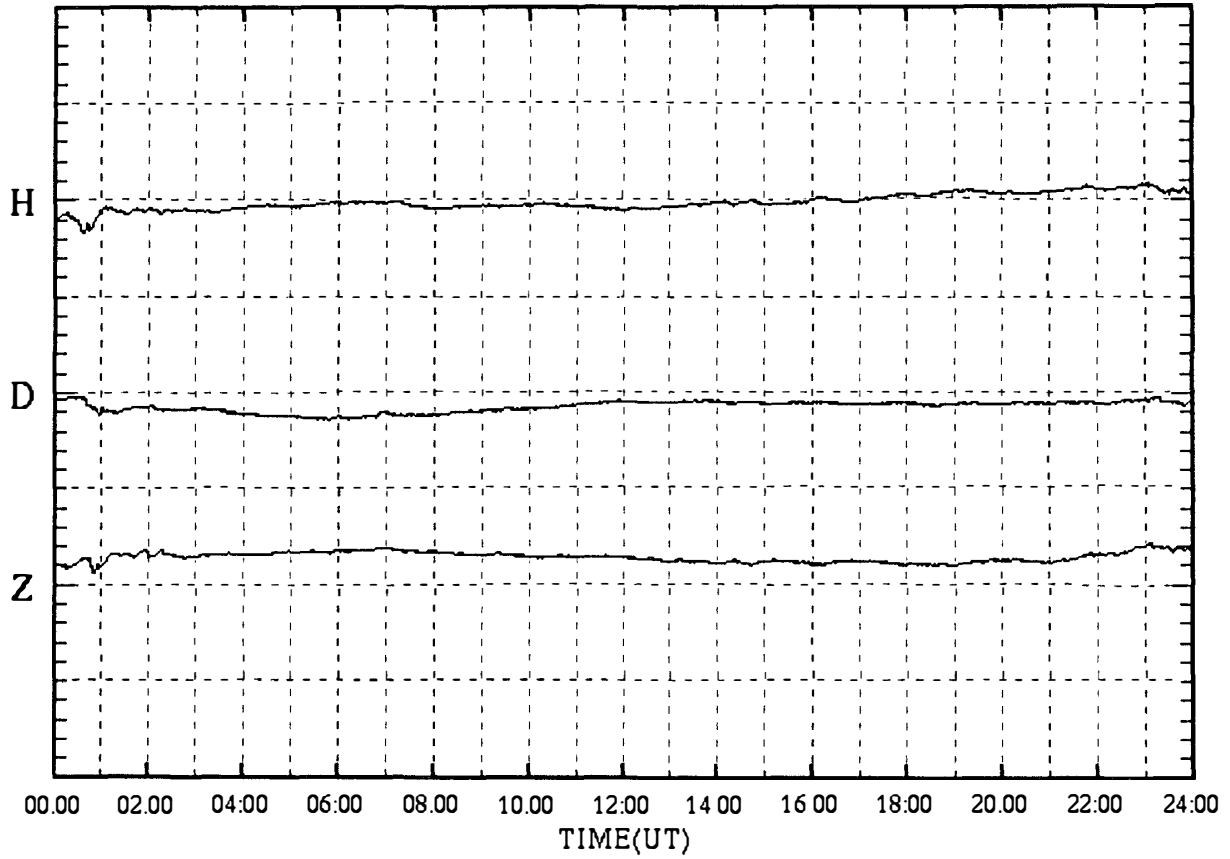

SYOWA magnetogram (100 nT/div)

16 Nov.1999 (DAY:320)

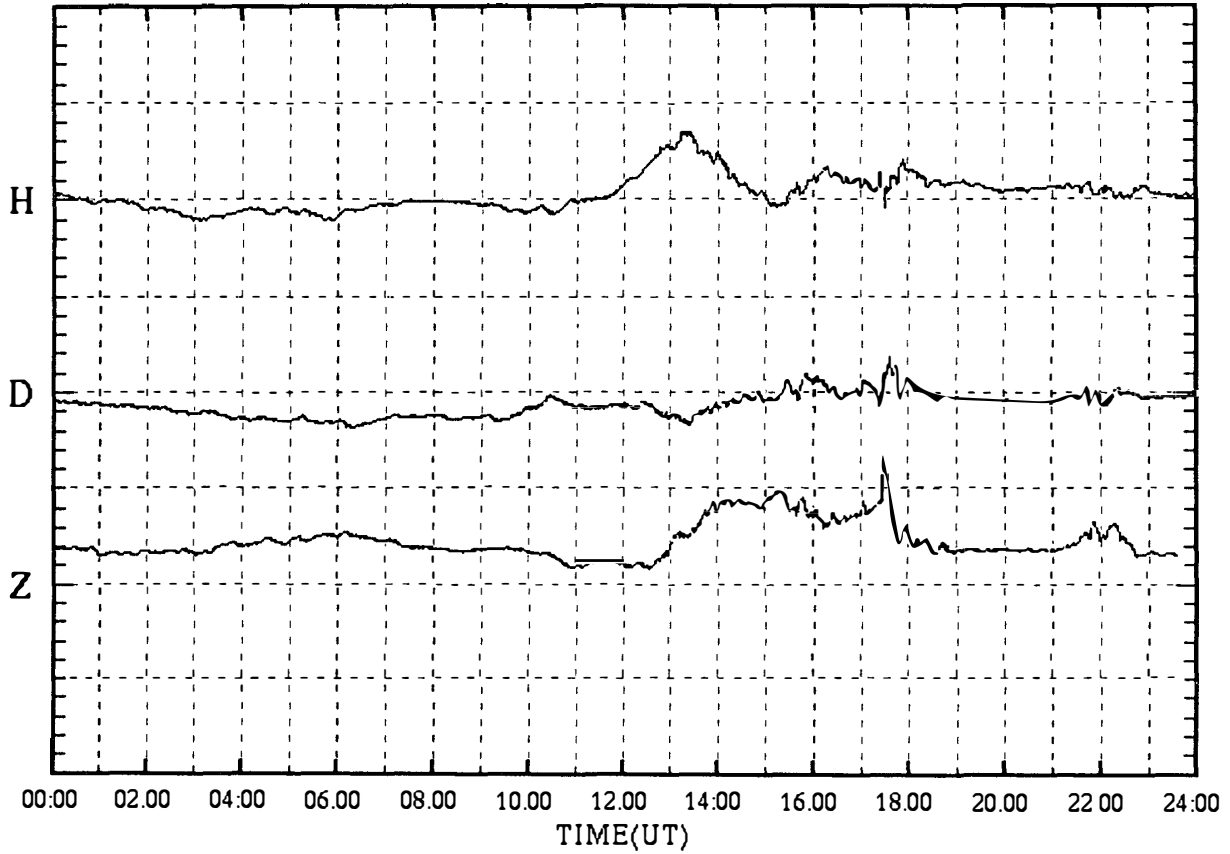



SYOWA magnetogram (100 nT/div)

17 Nov.1999 (DAY:321)

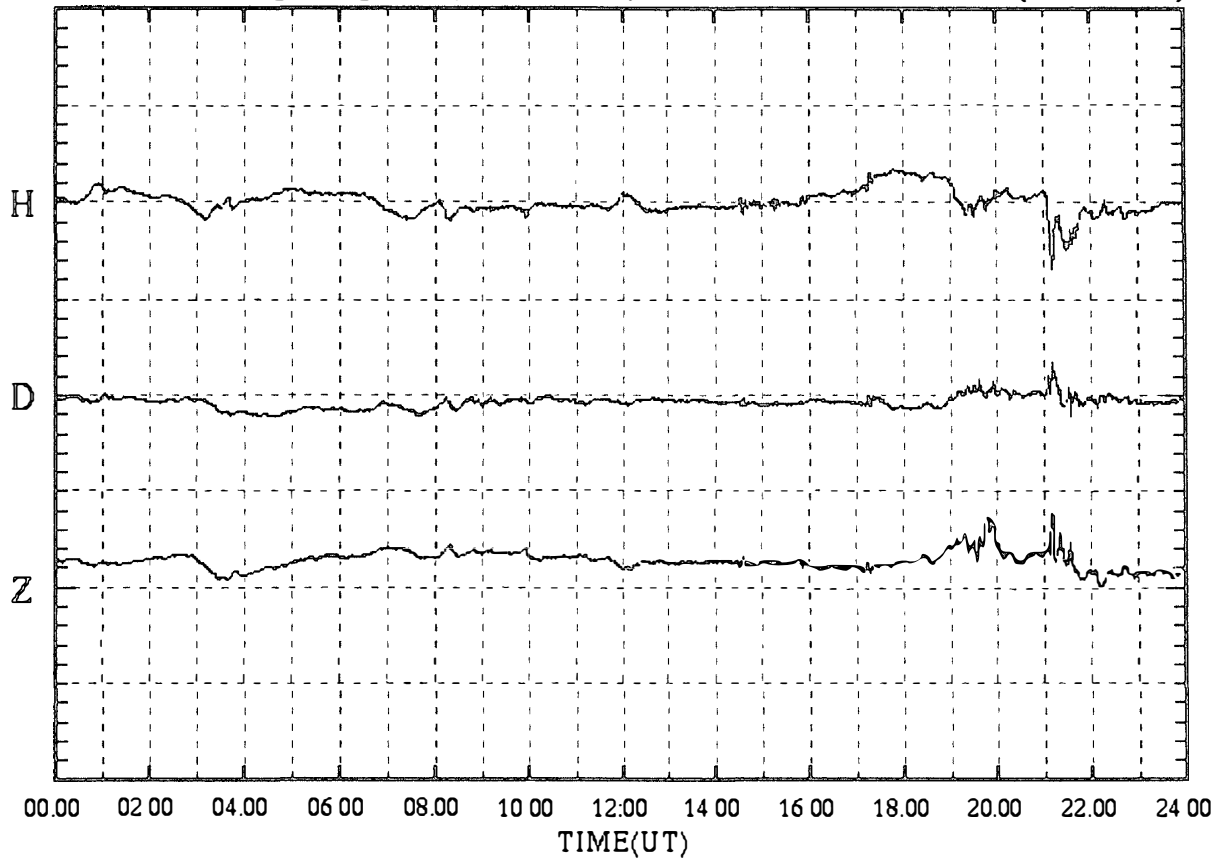

SYOWA magnetogram (100 nT/div)

18 Nov.1999 (DAY:322)

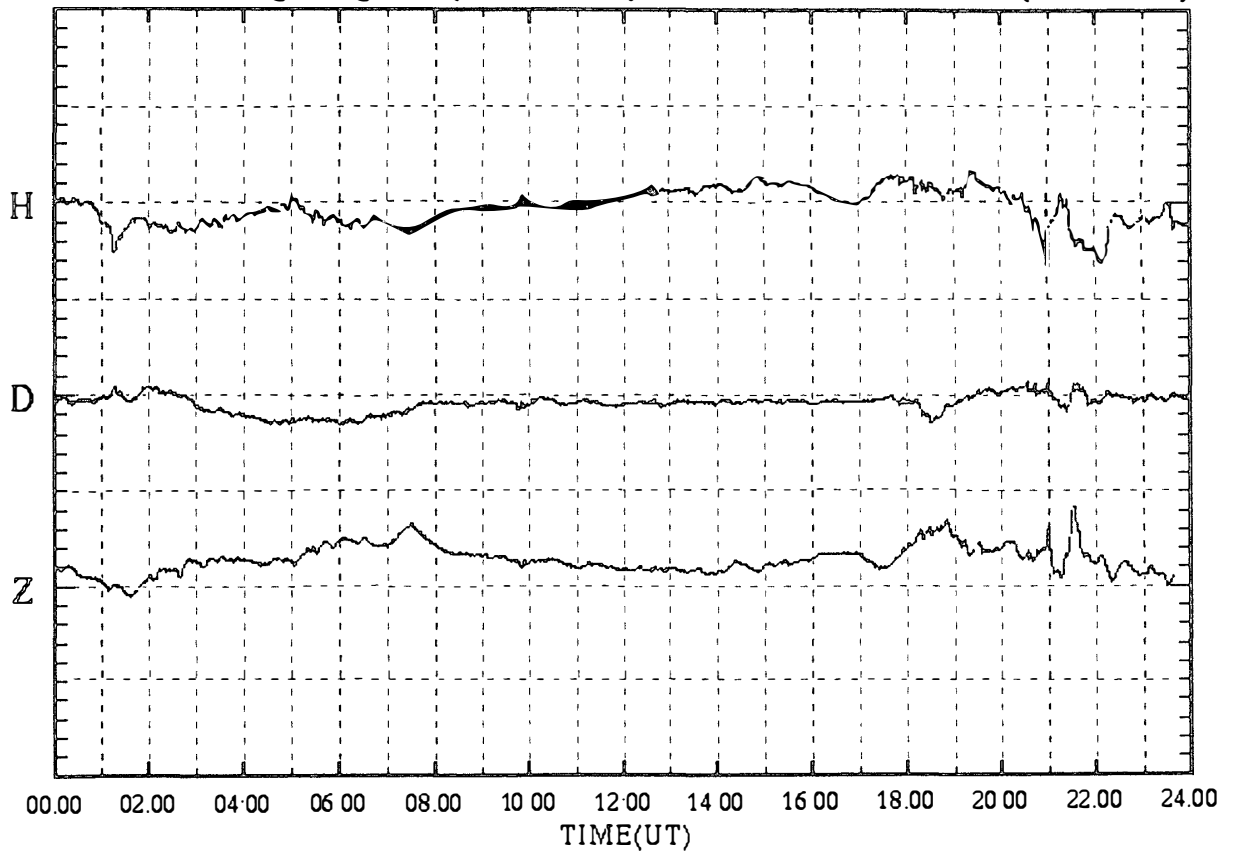

SYOWA magnetogram (100 nT/div)

19 Nov.1999 (DAY:323)

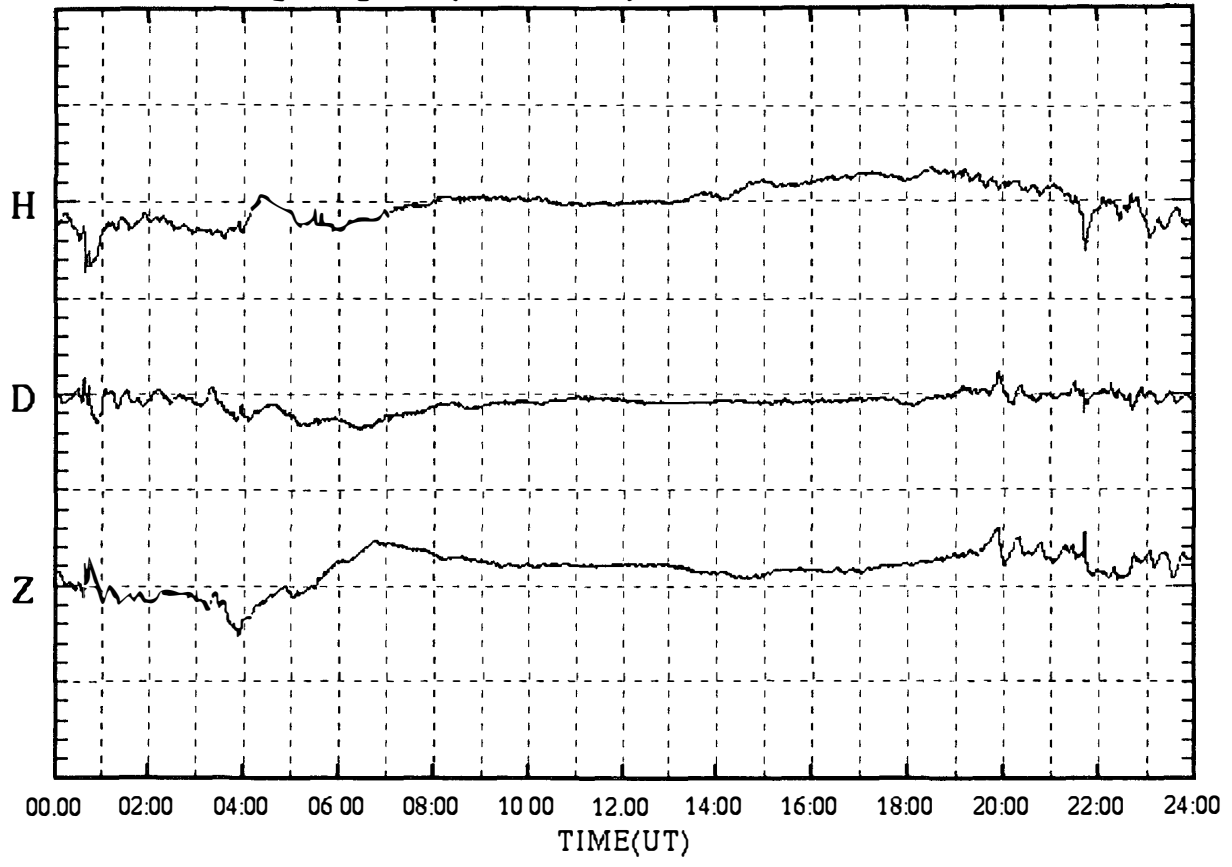

SYOWA magnetogram (100 nT/div)

20 Nov.1999 (DAY:324)

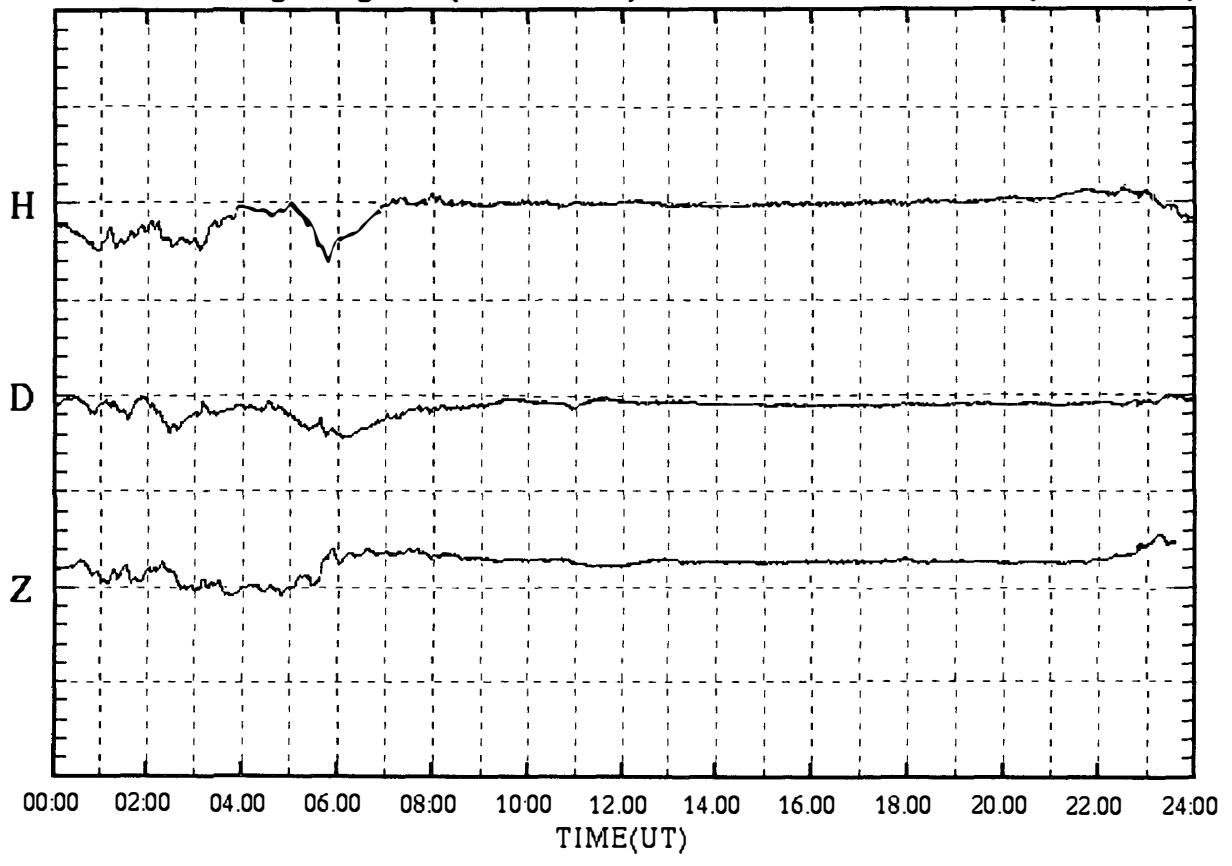

SYOWA magnetogram (100 nT/div)

21 Nov.1999 (DAY:325)

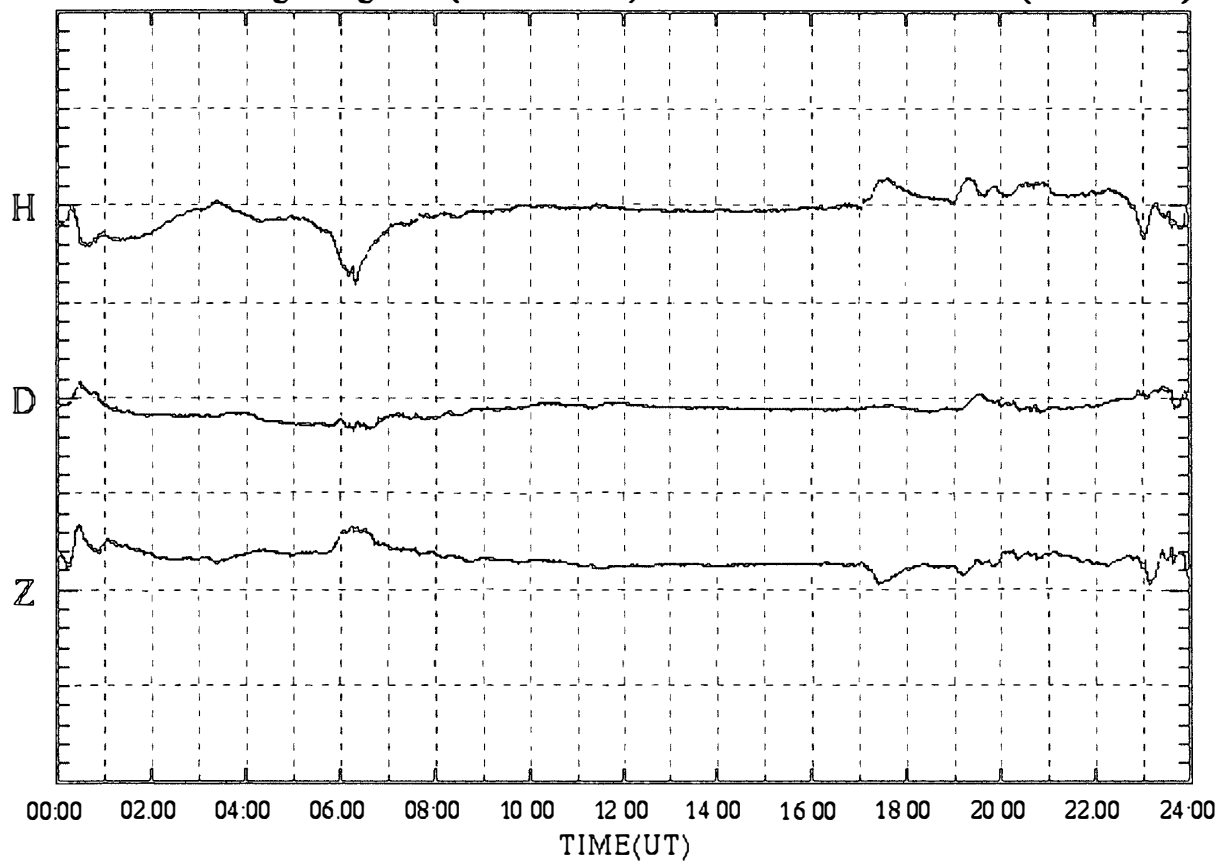

SYOWA magnetogram (100 nT/div)

22 Nov.1999 (DAY:326)

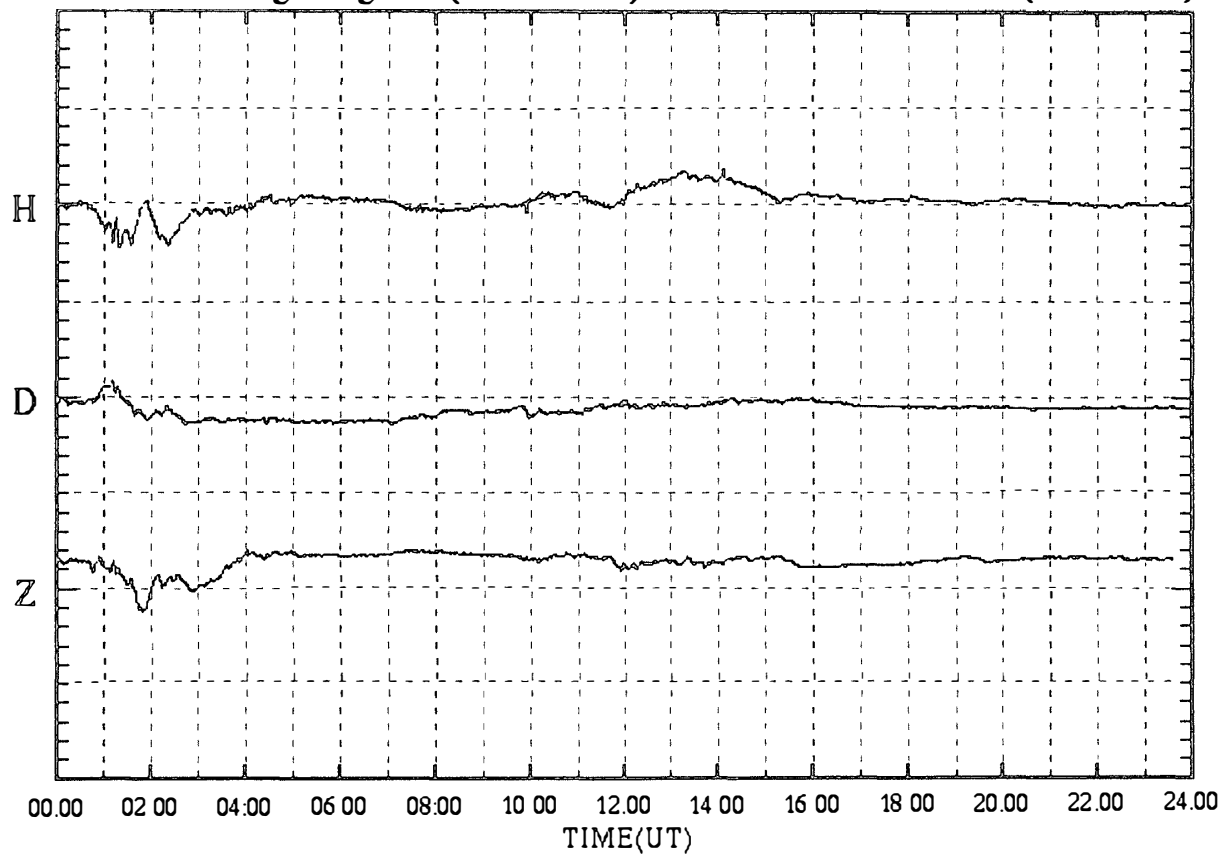

SYOWA magnetogram (100 nT/div)

23 Nov.1999 (DAY:327)

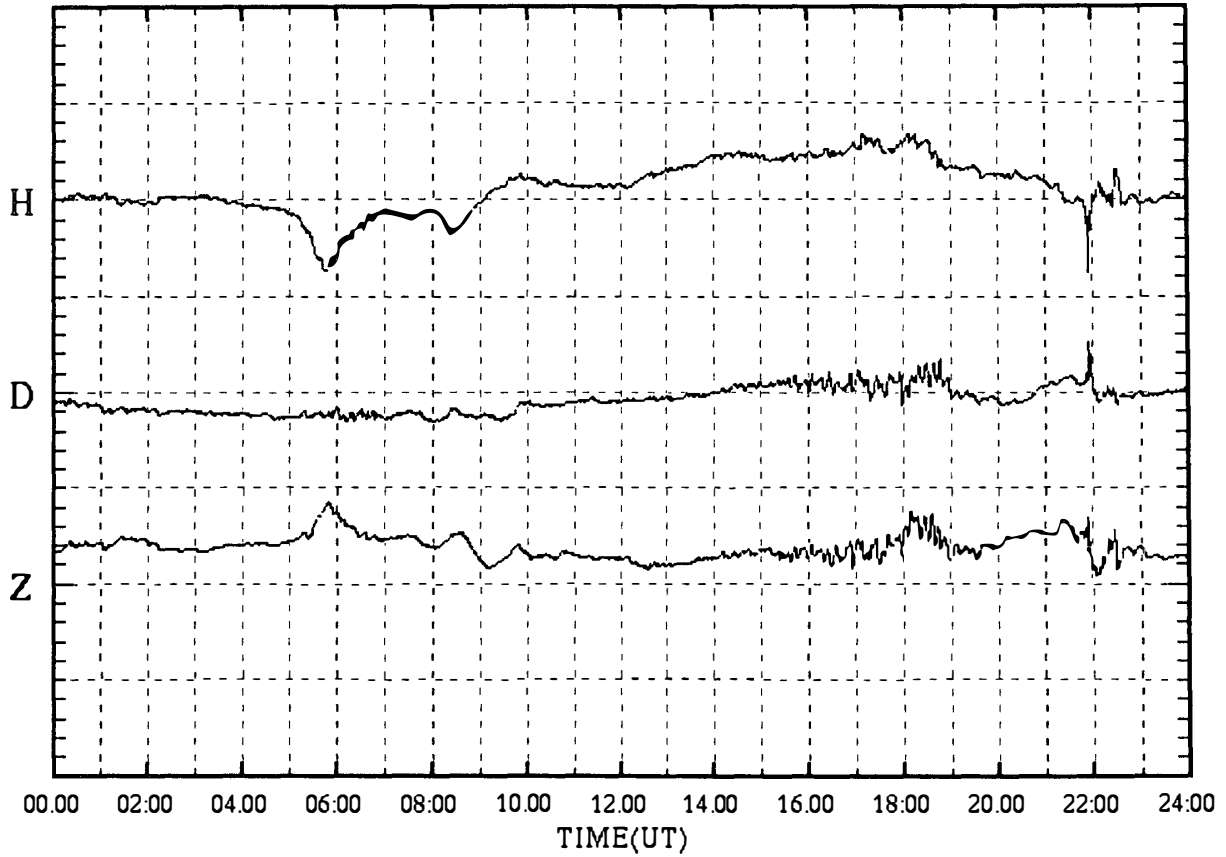

SYOWA magnetogram (100 nT/div)

24 Nov.1999 (DAY:328)

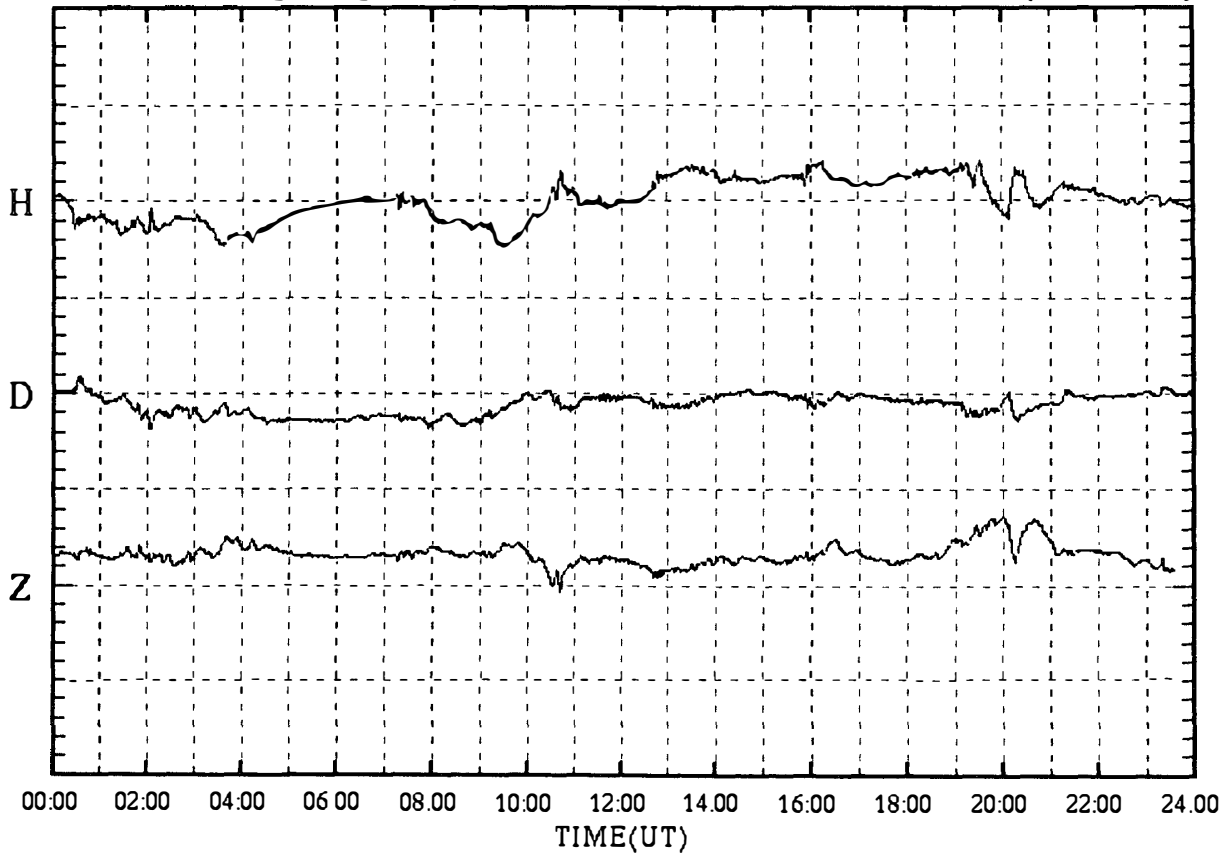

SYOWA magnetogram (100 nT/div)

25 Nov.1999 (DAY:329)

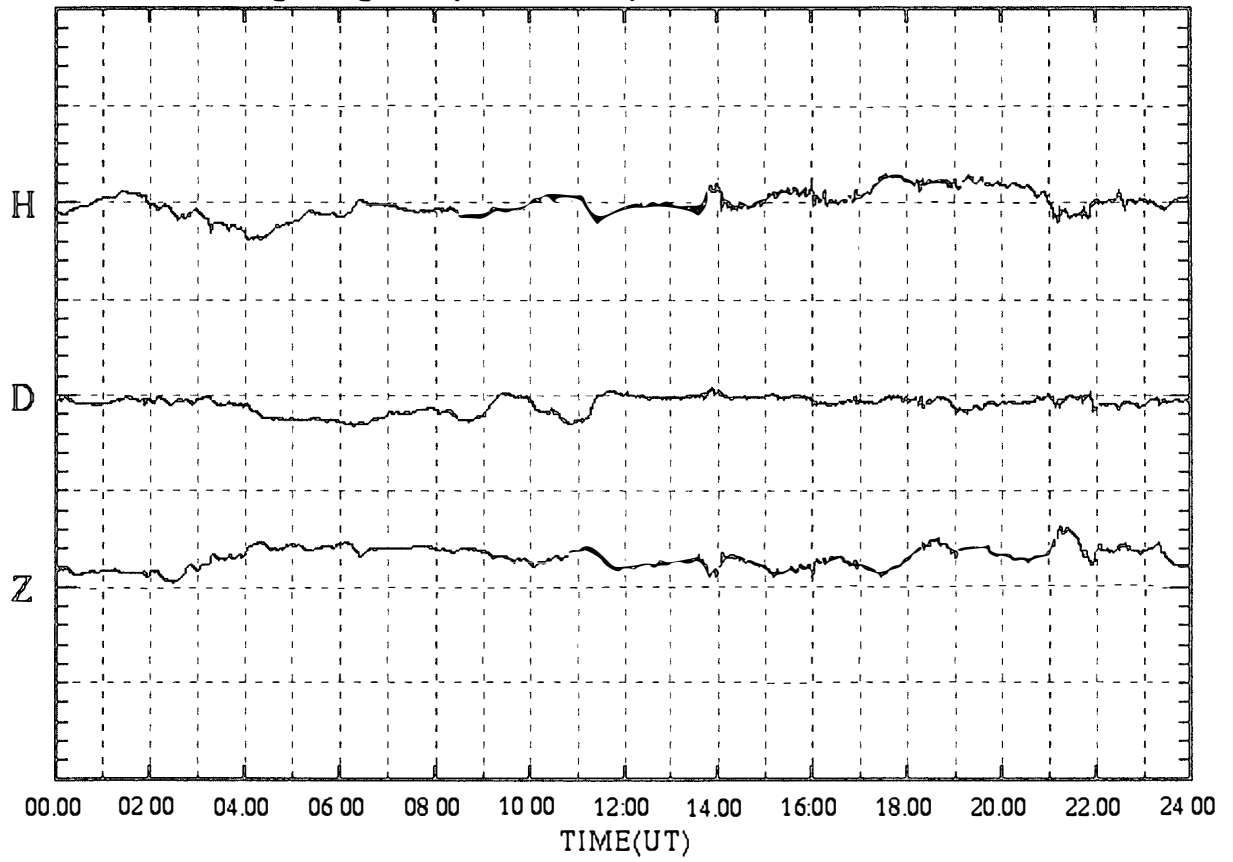

SYOWA magnetogram (100 nT/div)

26 Nov.1999 (DAY:330)

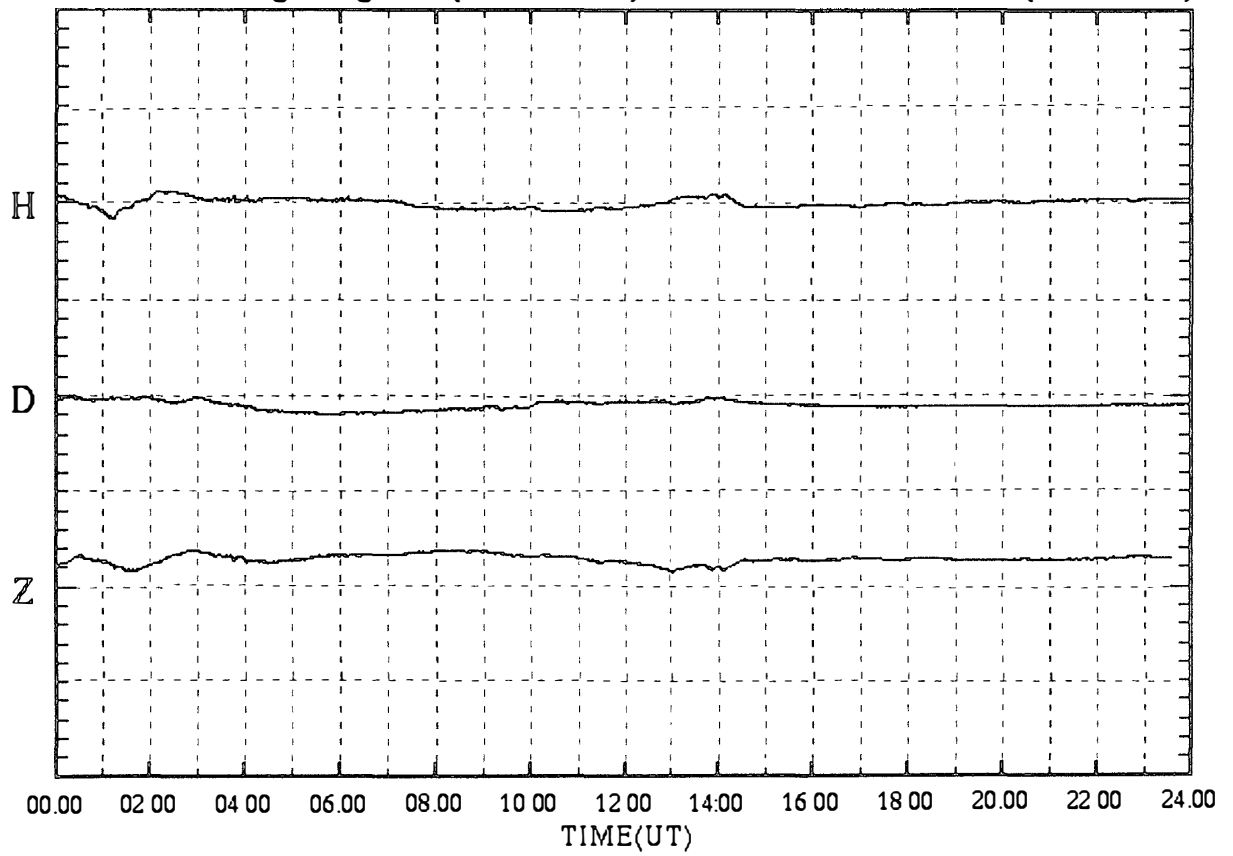

SYOWA magnetogram (100 nT/div)

27 Nov.1999 (DAY:331)

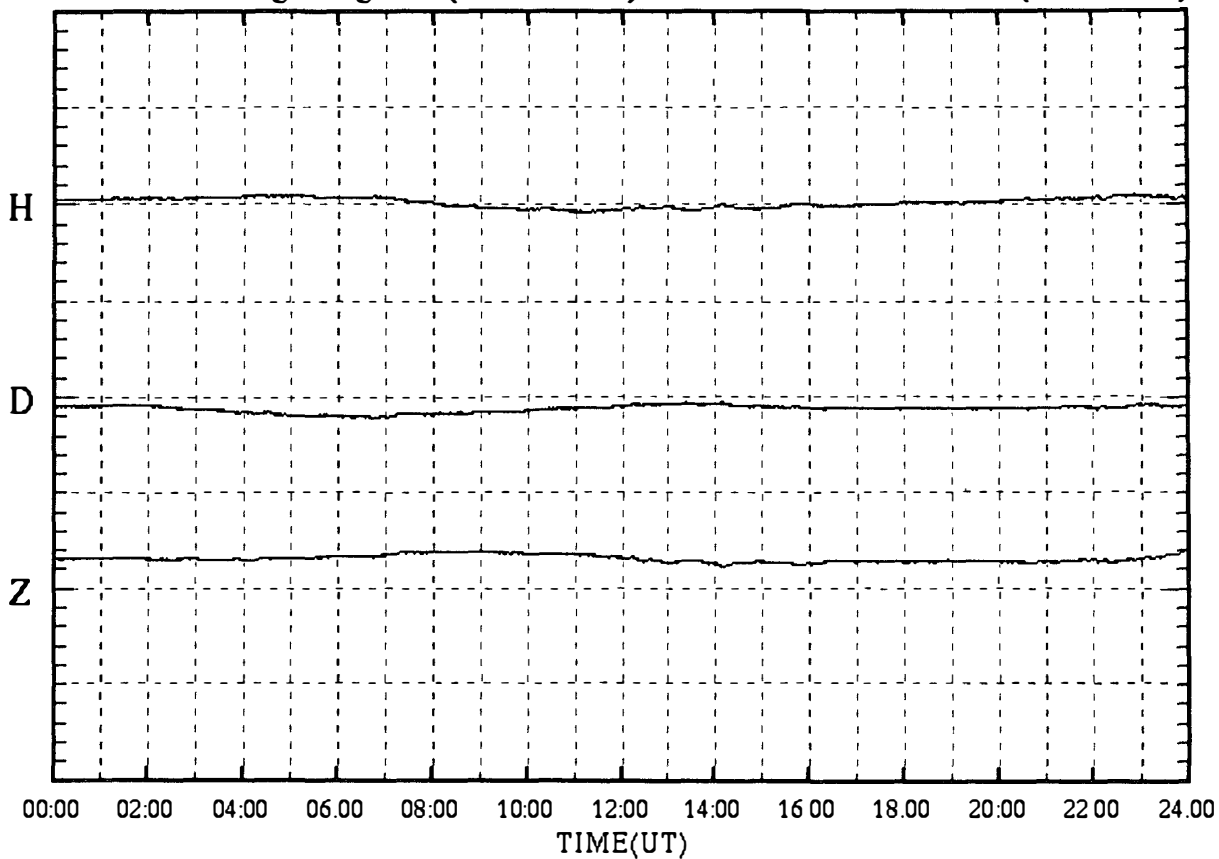

SYOWA magnetogram (100 nT/div)

28 Nov.1999 (DAY:332)

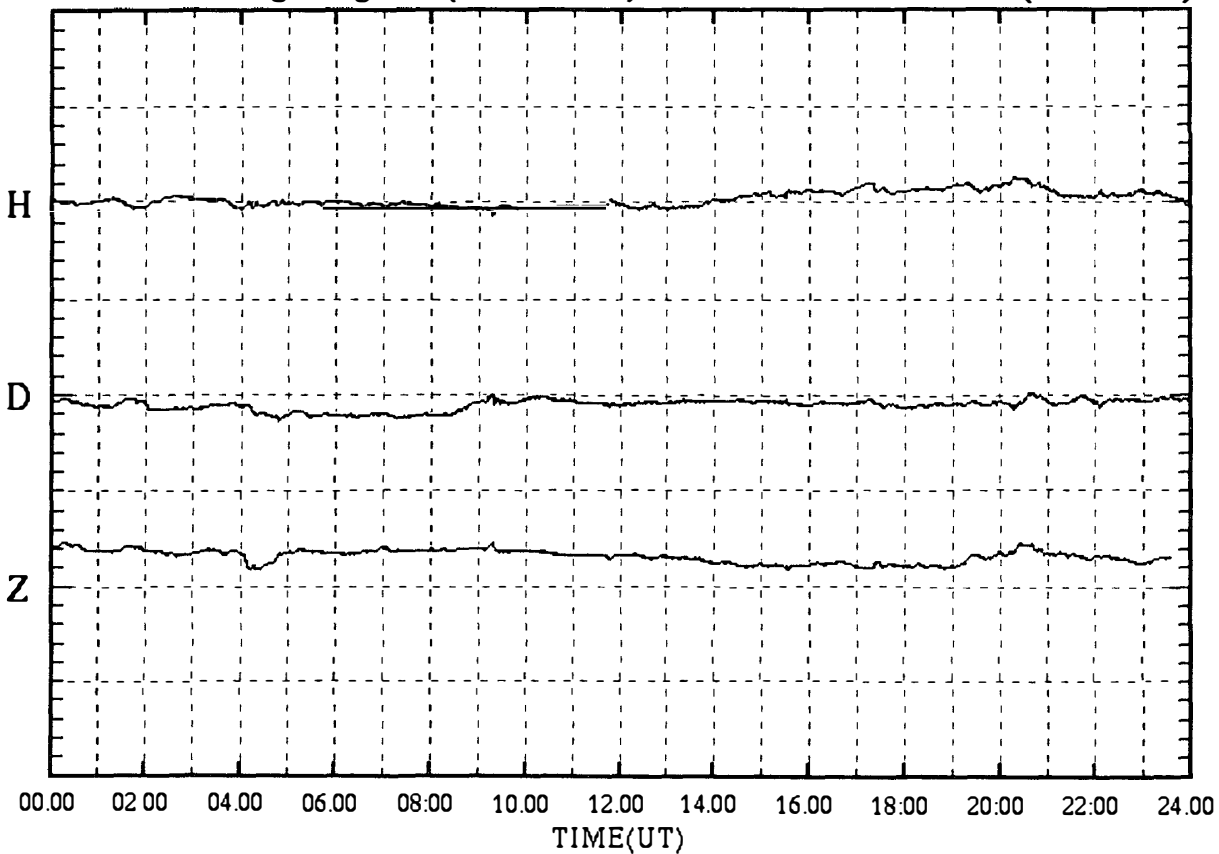

SYOWA magnetogram (100 nT/div)

29 Nov.1999 (DAY:333)

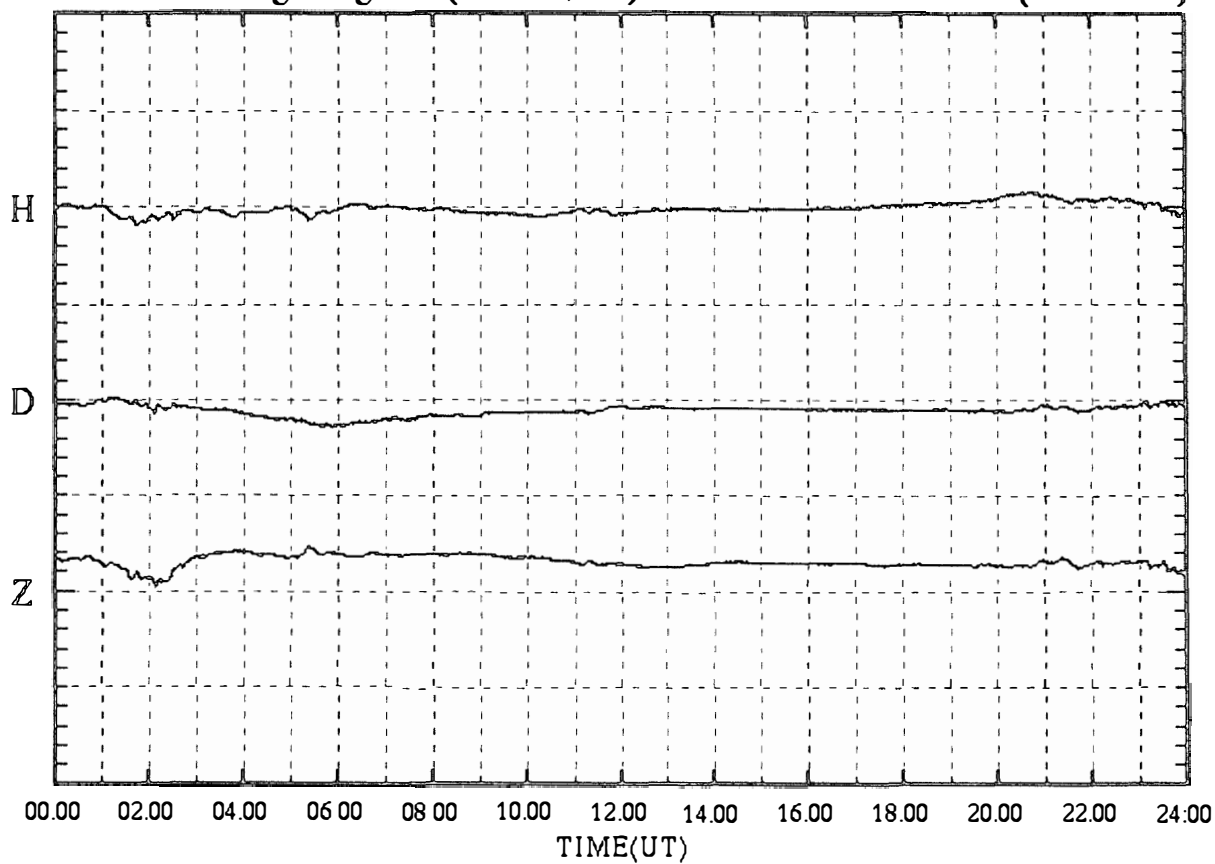

SYOWA magnetogram (100 nT/div)

30 Nov.1999 (DAY:334)

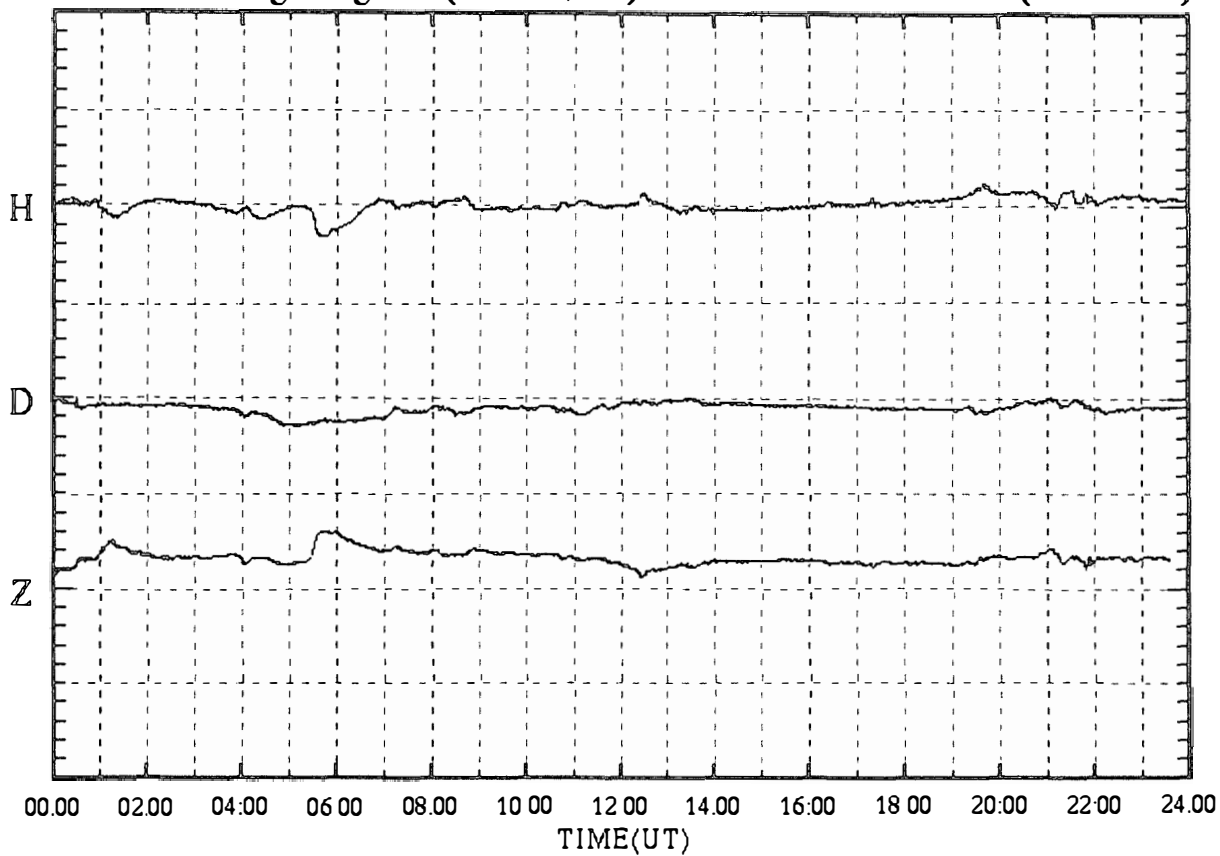

SYOWA magnetogram (100 nT/div)

01 Dec.1999 (DAY:335)

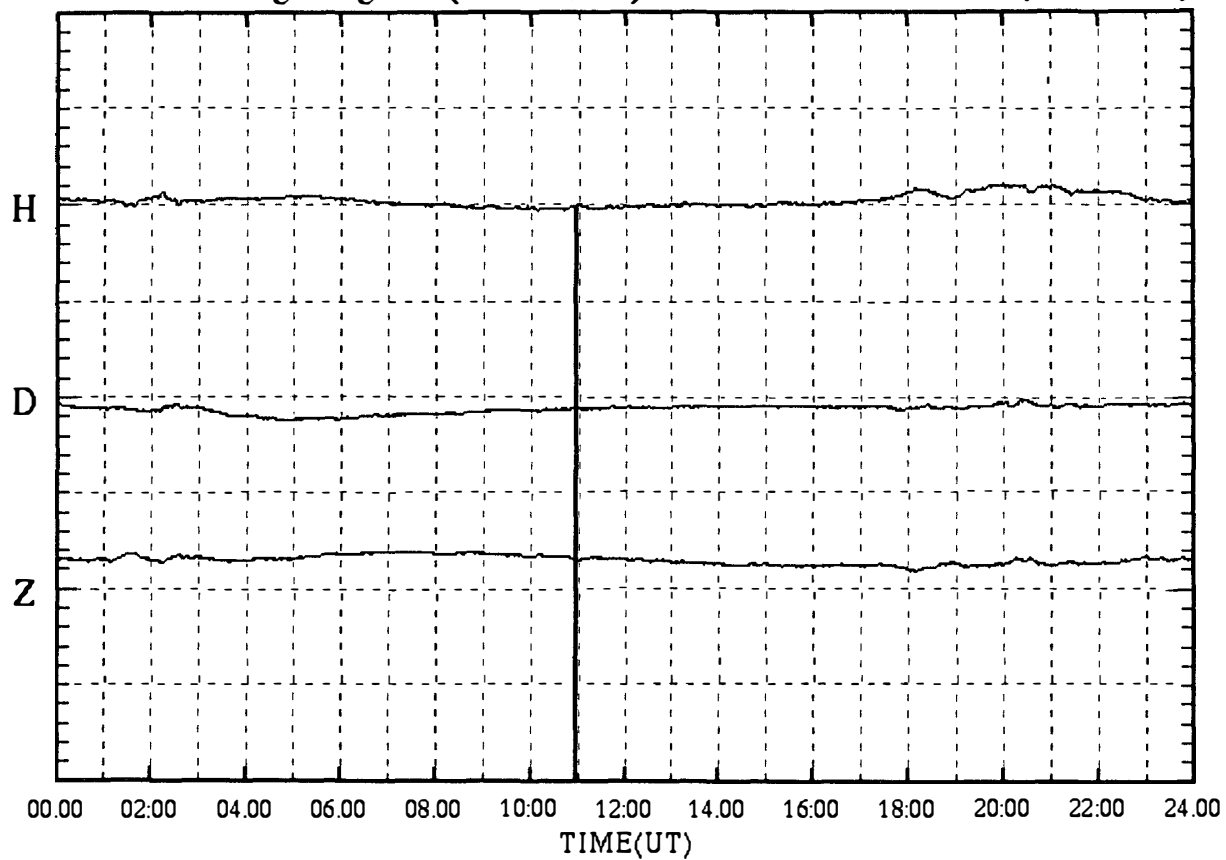

SYOWA magnetogram (100 nT/div)

02 Dec.1999 (DAY:336)

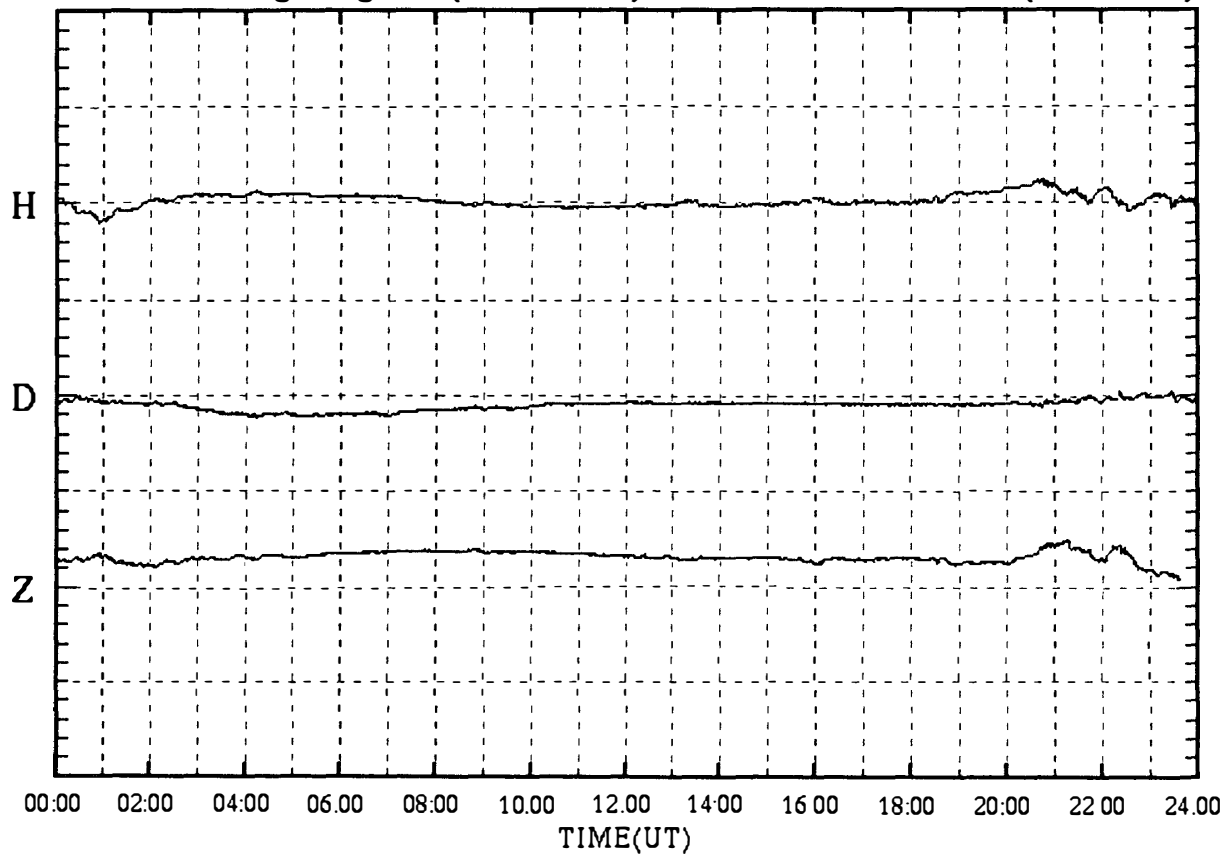



SYOWA magnetogram (100 nT/div)

03 Dec.1999 (DAY:337)

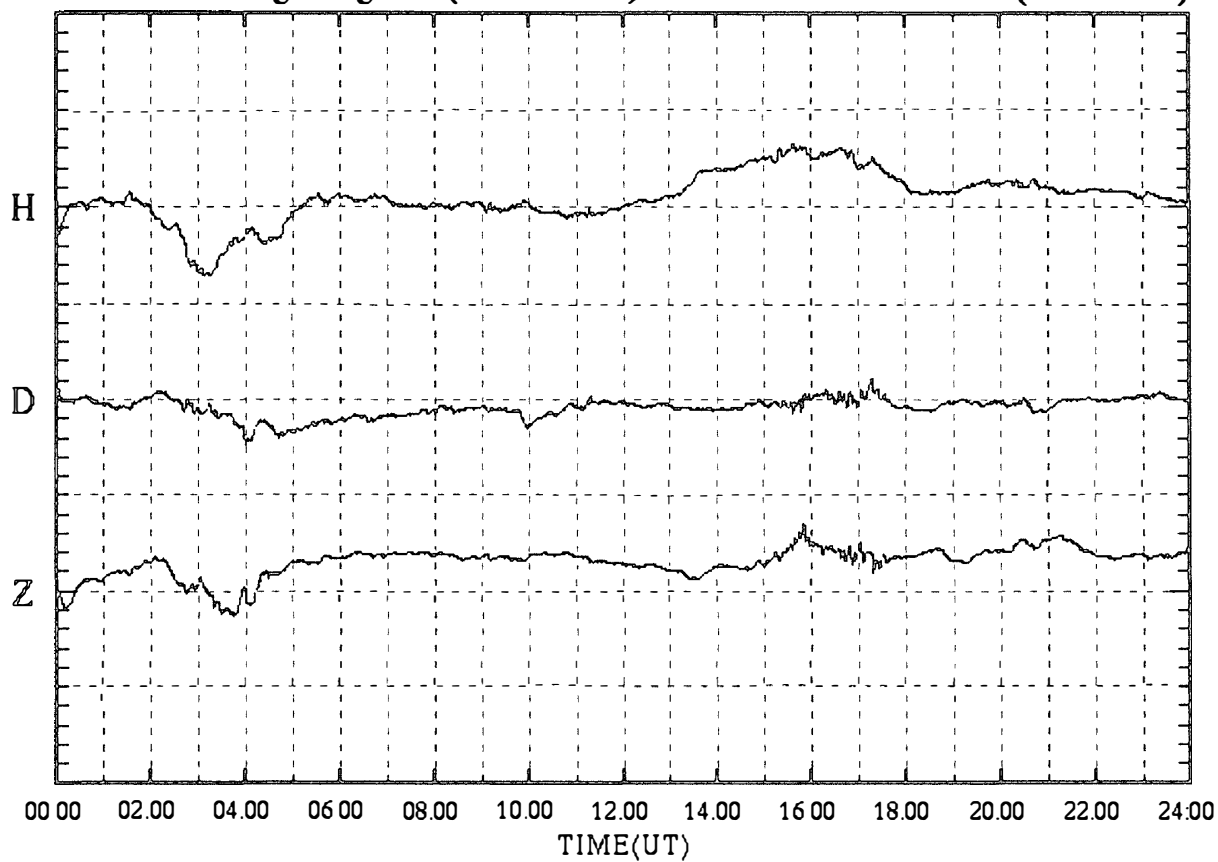

SYOWA magnetogram (100 nT/div)

04 Dec.1999 (DAY:338)

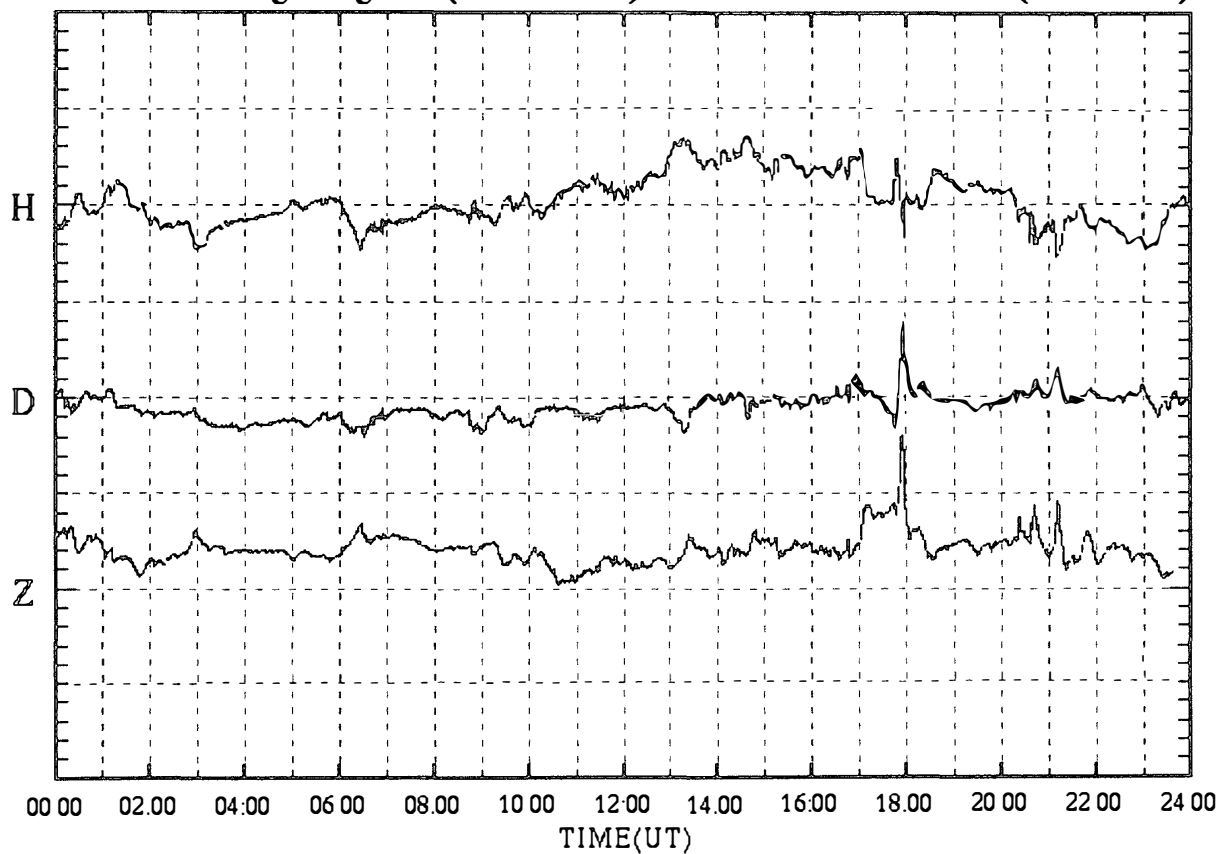

SYOWA magnetogram (100 nT/div)

05 Dec.1999 (DAY:339)

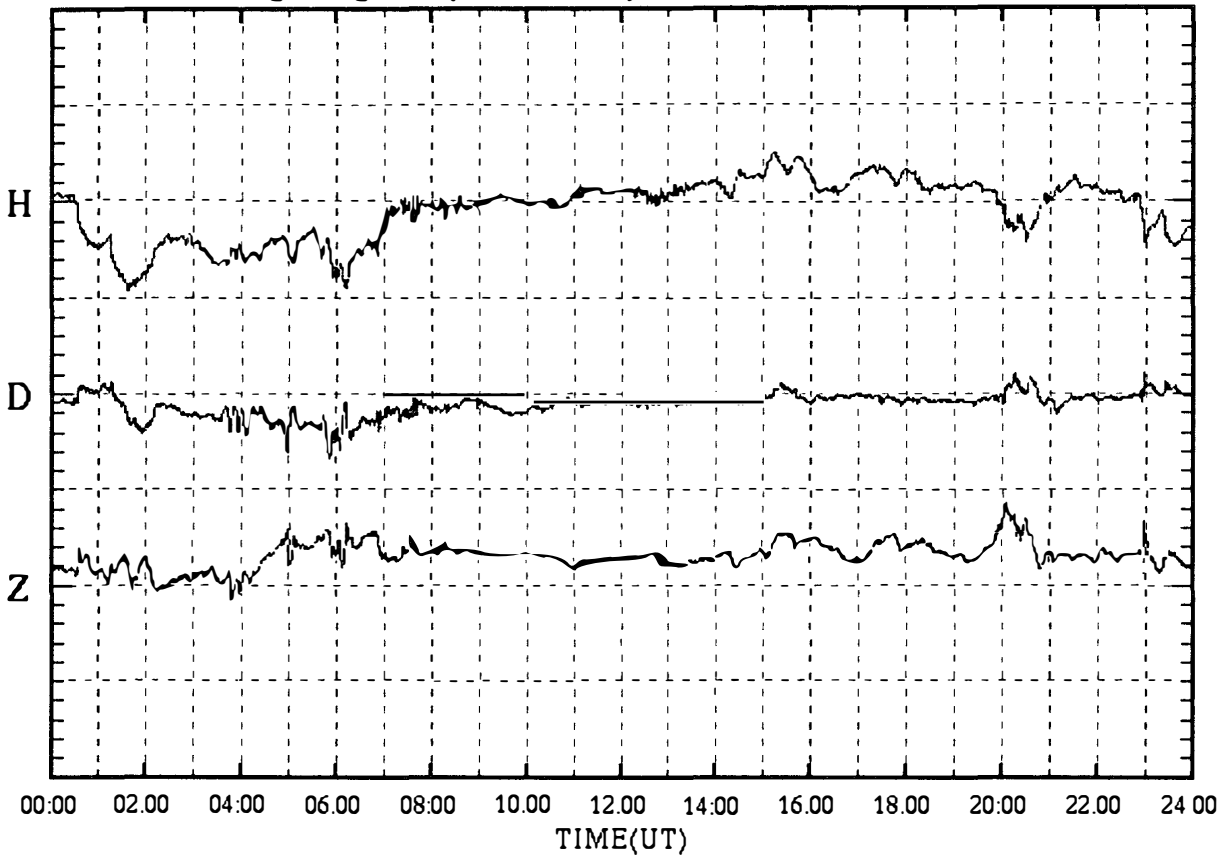

SYOWA magnetogram (100 nT/div)

06 Dec.1999 (DAY:340)

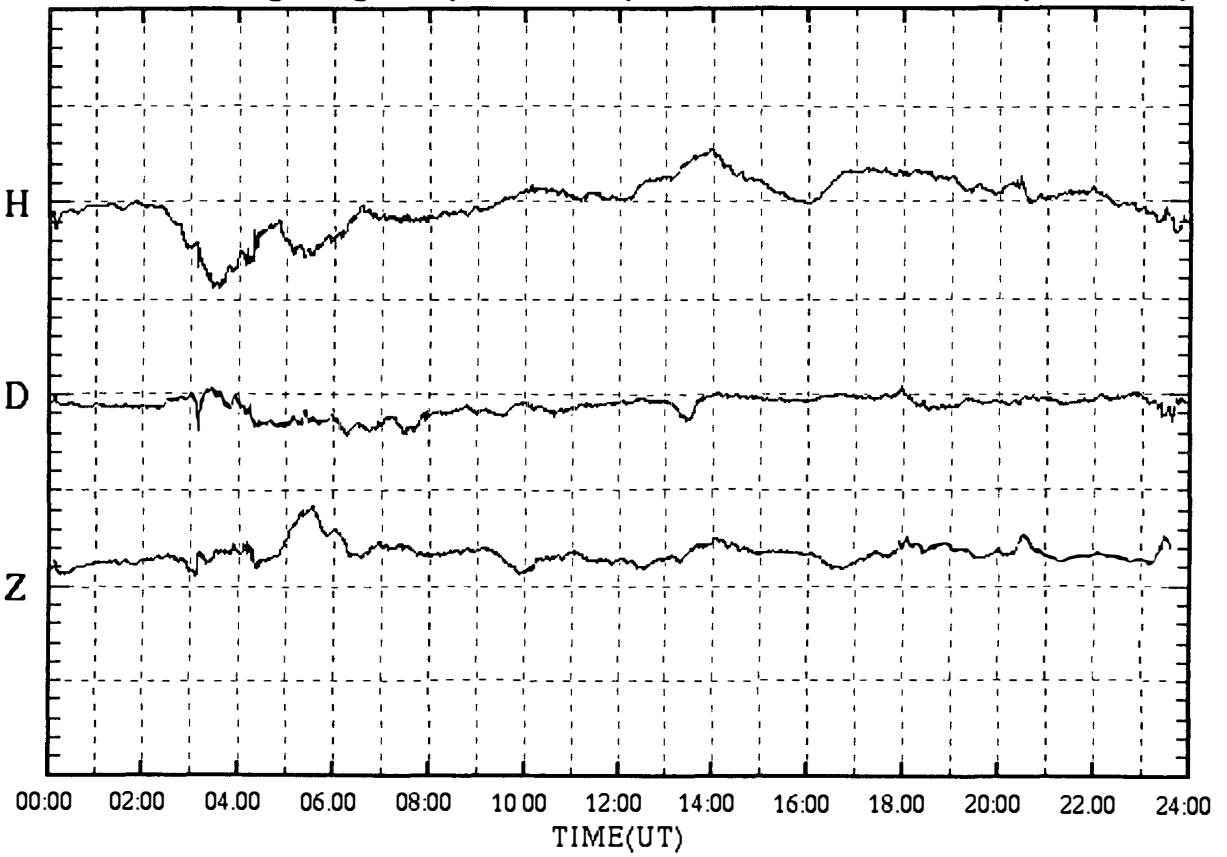

SYOWA magnetogram (100 nT/div)

07 Dec.1999 (DAY:341)

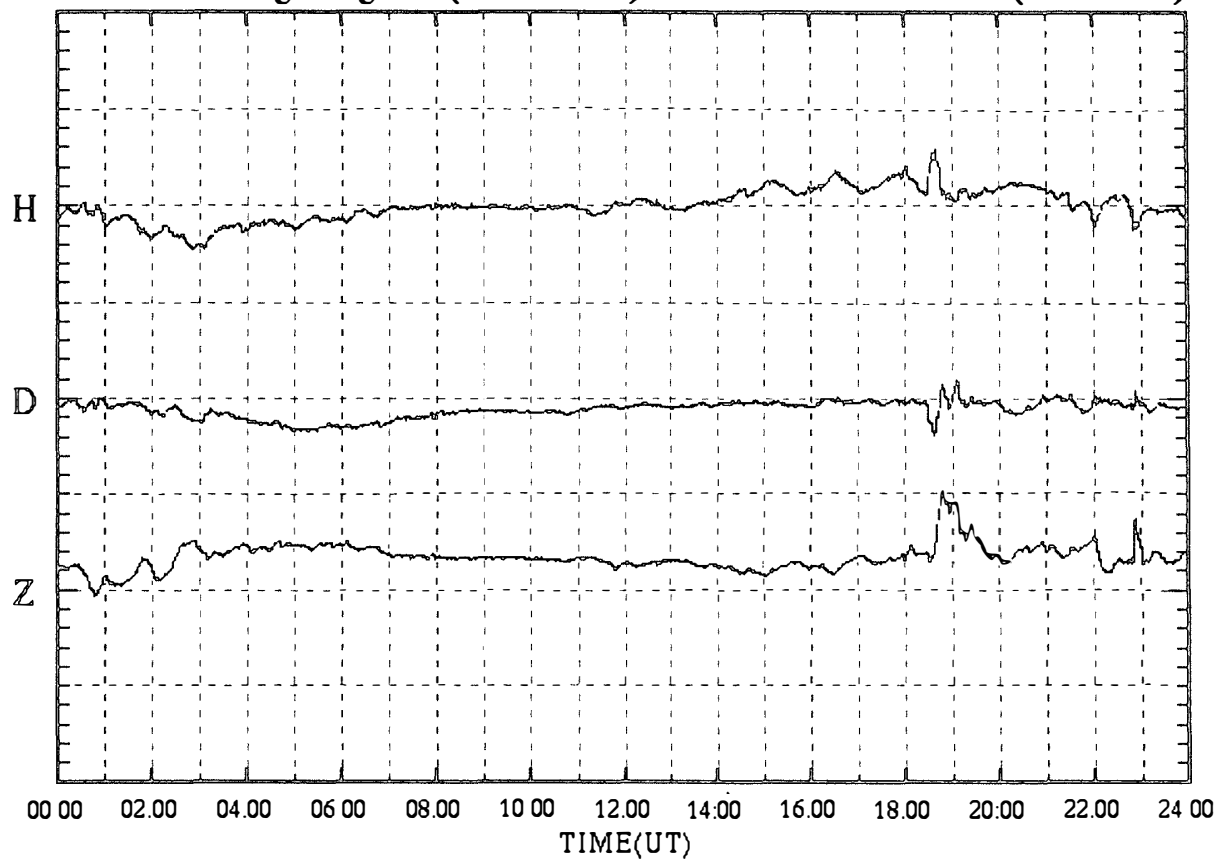

SYOWA magnetogram (100 nT/div)

08 Dec.1999 (DAY:342)

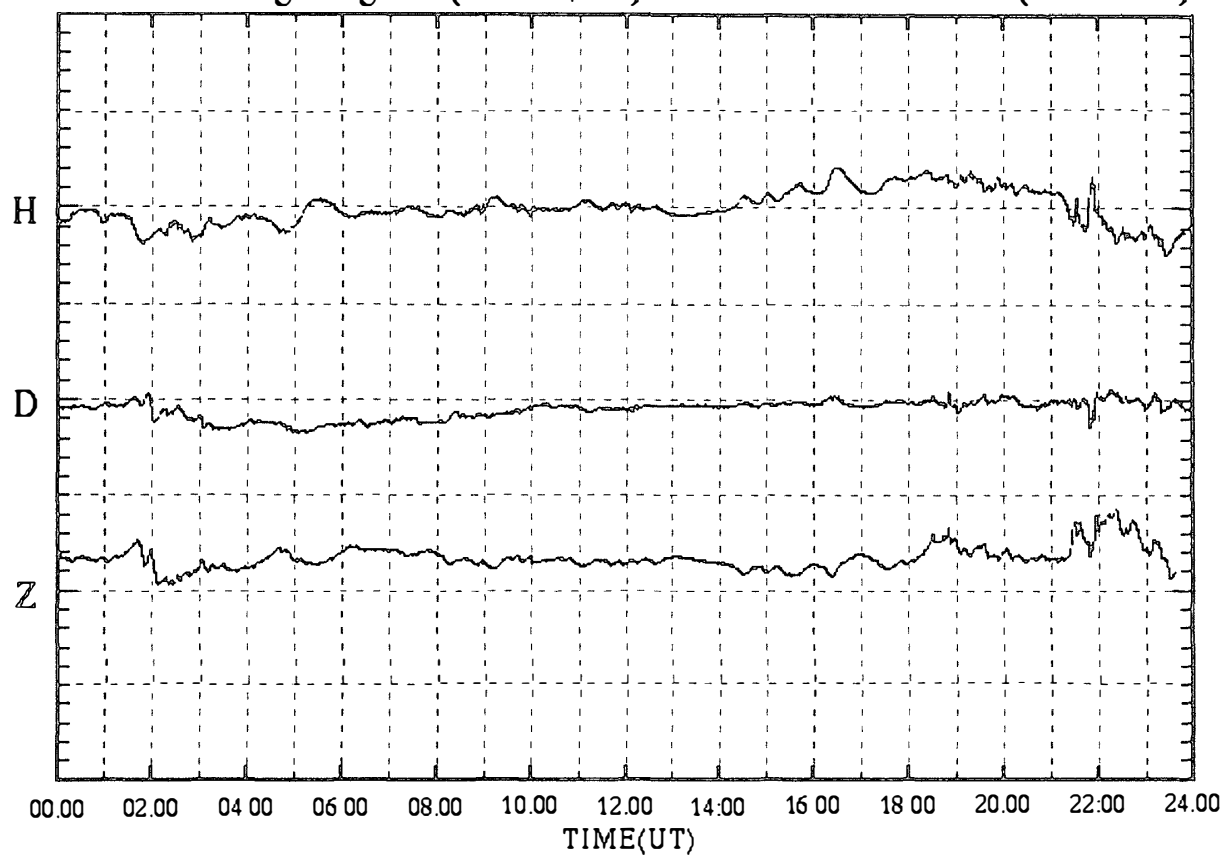

SYOWA magnetogram (100 nT/div)

09 Dec.1999 (DAY:343)

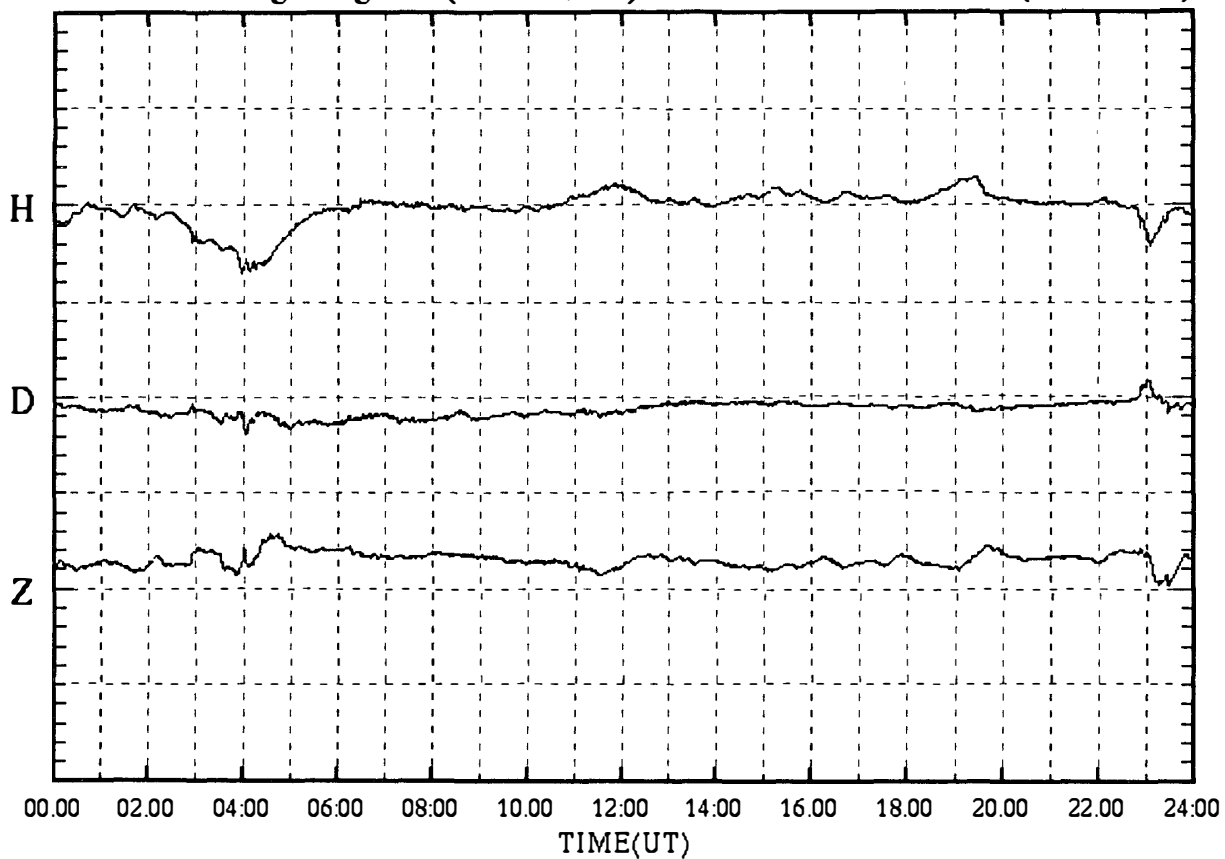

SYOWA magnetogram (100 nT/div)

10 Dec.1999 (DAY:344)

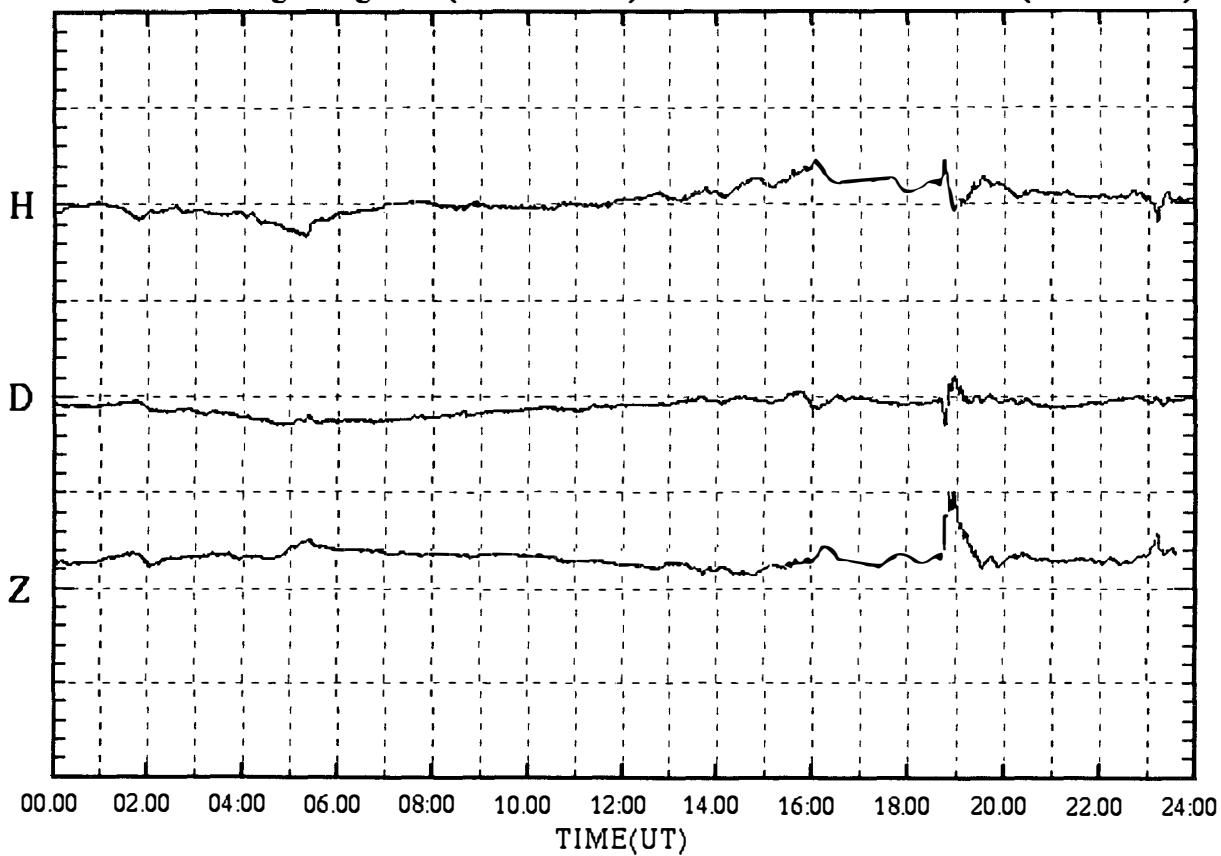

SYOWA magnetogram (100 nT/div)

11 Dec.1999 (DAY:345)

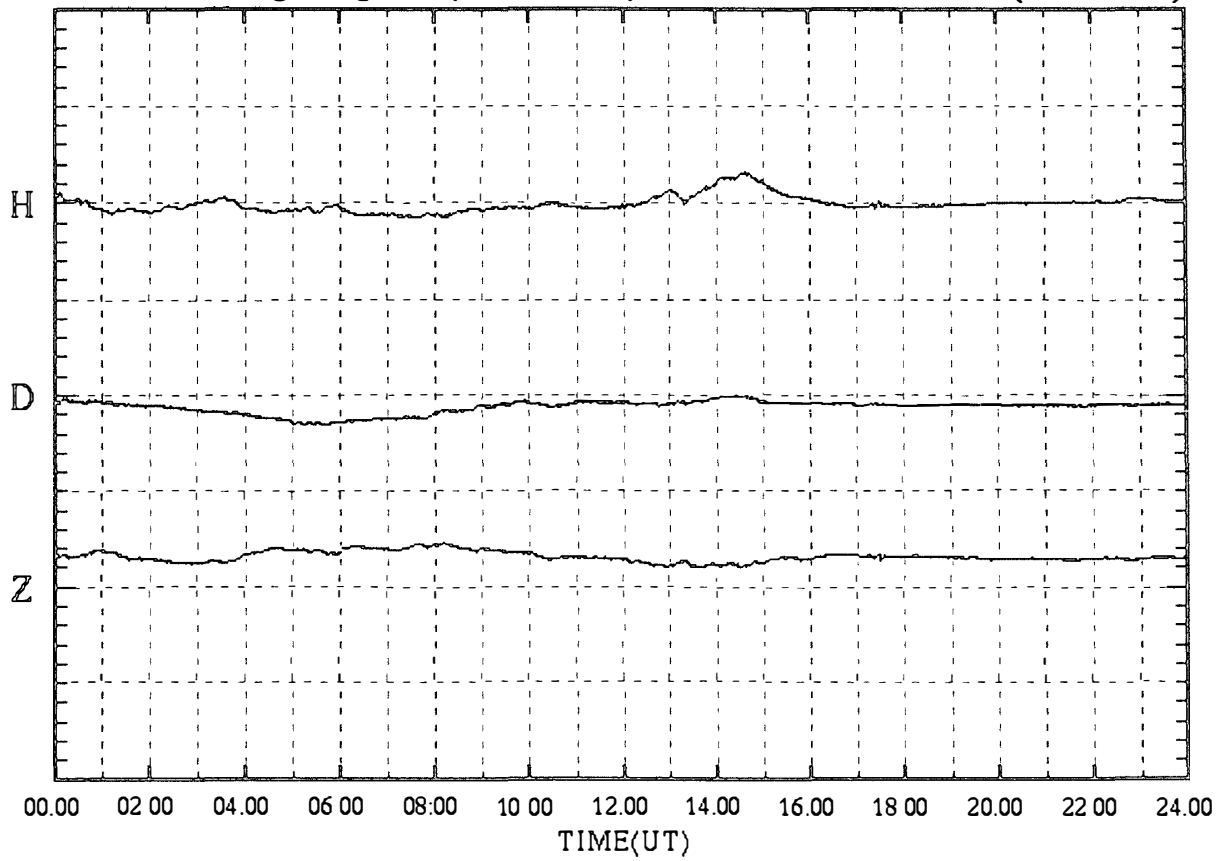

SYOWA magnetogram (100 nT/div)

12 Dec.1999 (DAY:346)

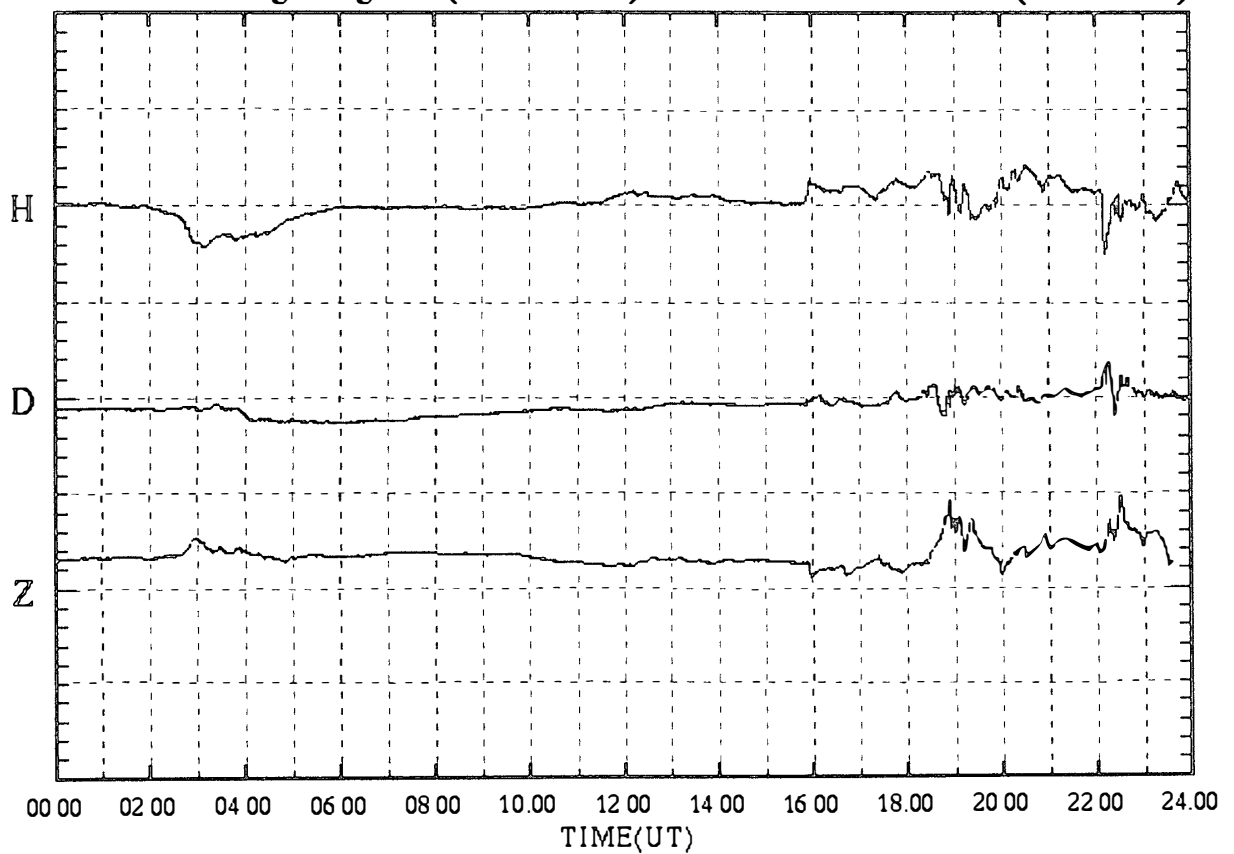

SYOWA magnetogram (100 nT/div)

13 Dec.1999 (DAY:347)

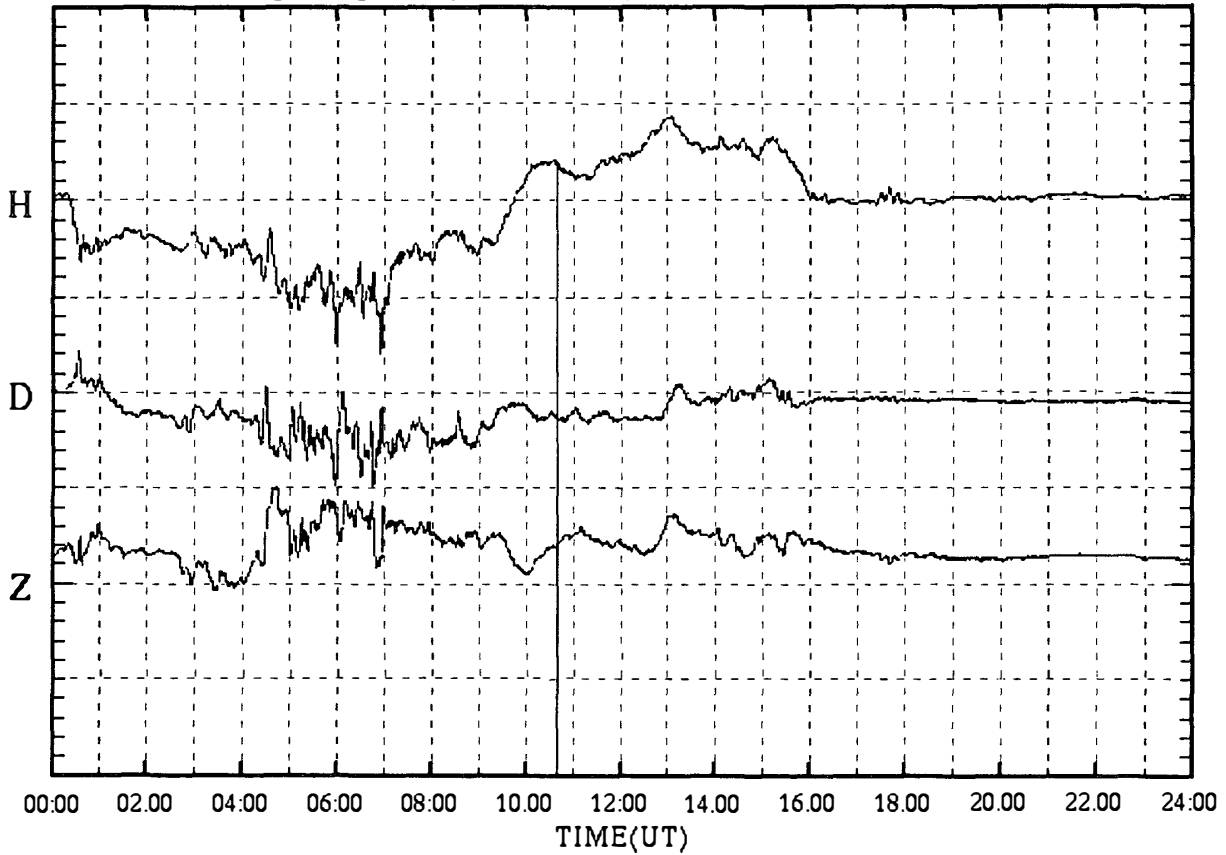

SYOWA magnetogram (100 nT/div)

14 Dec.1999 (DAY:348)

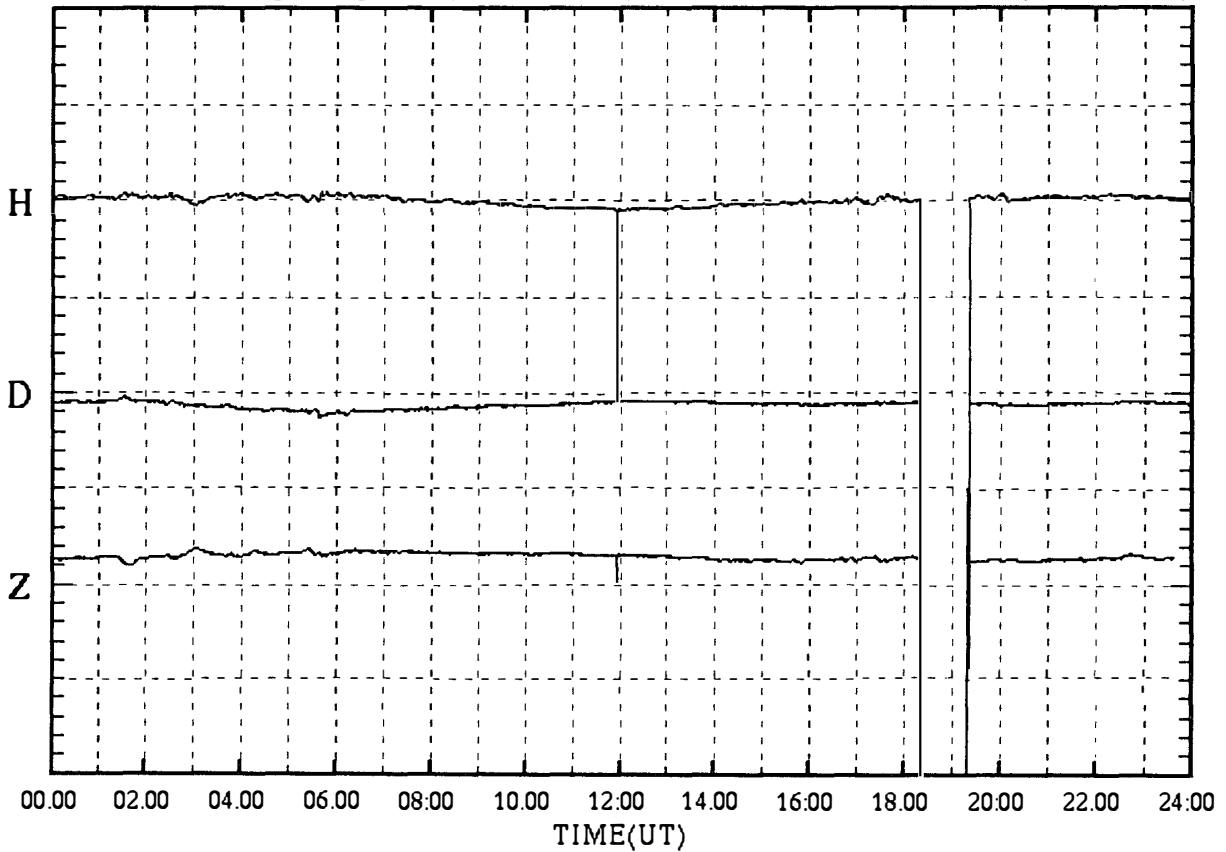

SYOWA magnetogram (100 nT/div)

15 Dec.1999 (DAY:349)

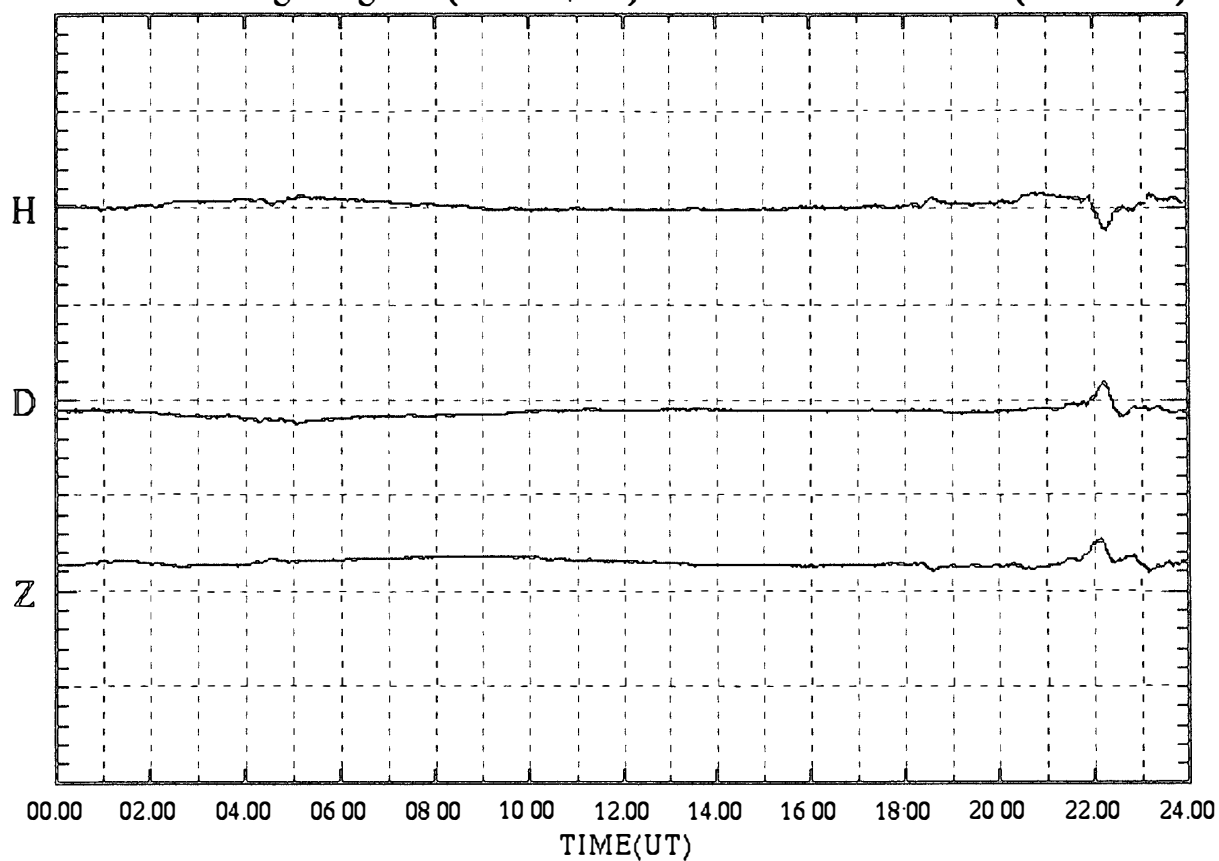

SYOWA magnetogram (100 nT/div)

16 Dec.1999 (DAY:350)

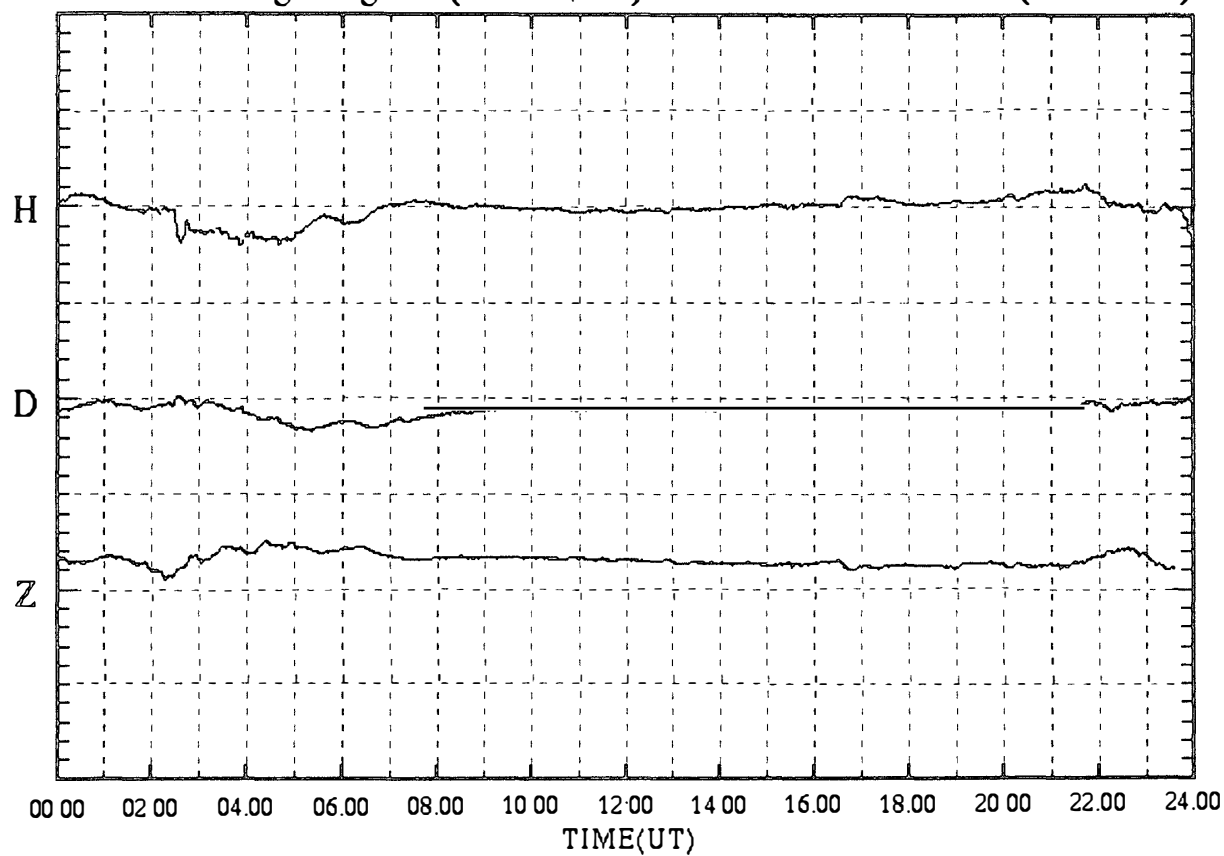

SYOWA magnetogram (100 nT/div)

17 Dec.1999 (DAY:351)

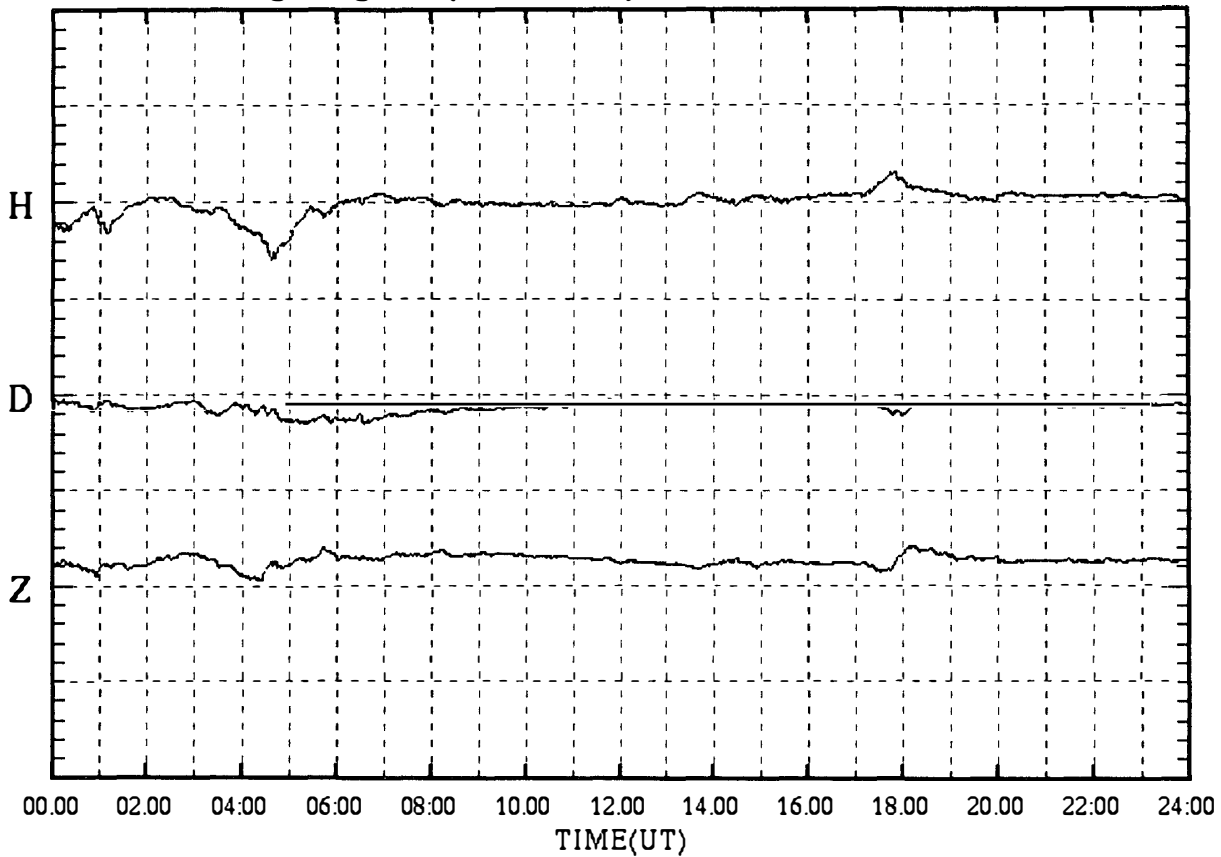

SYOWA magnetogram (100 nT/div)

18 Dec.1999 (DAY:352)

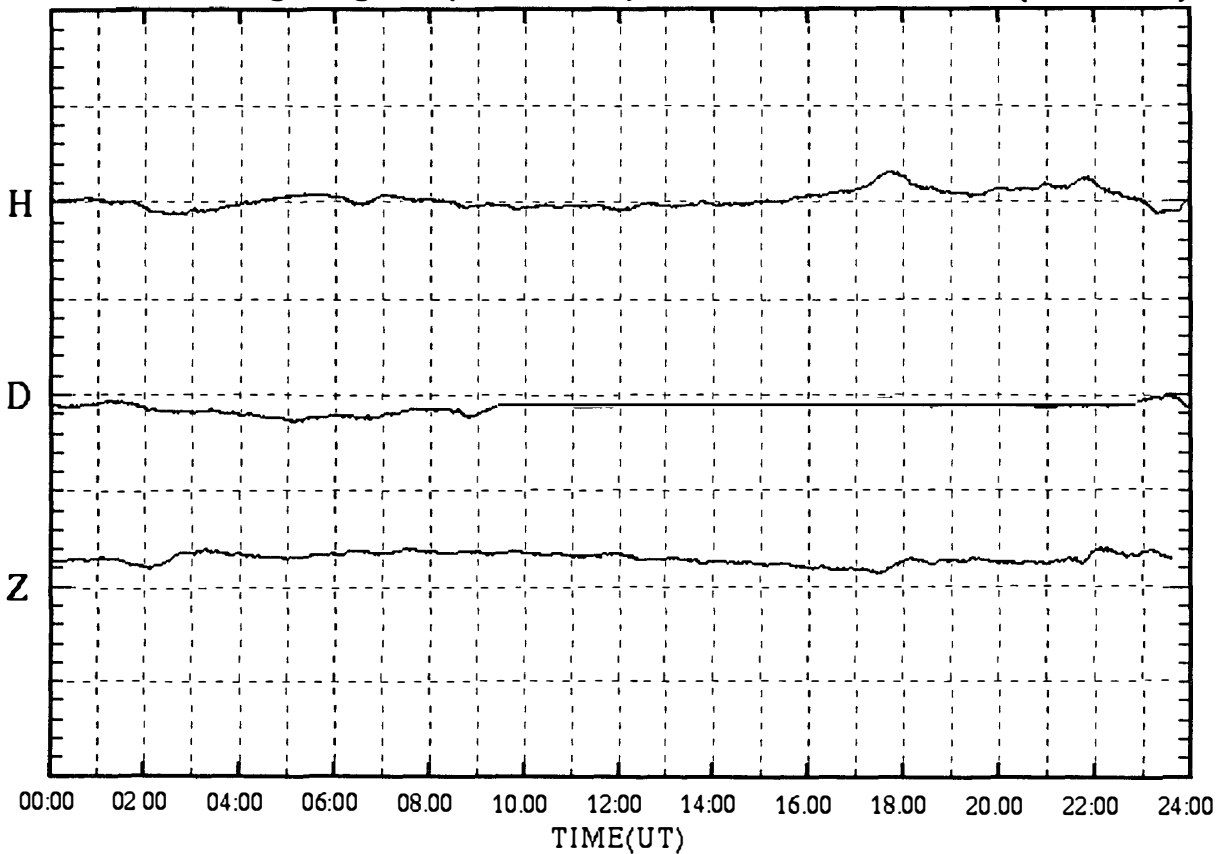



SYOWA magnetogram (100 nT/div)

19 Dec.1999 (DAY:353)

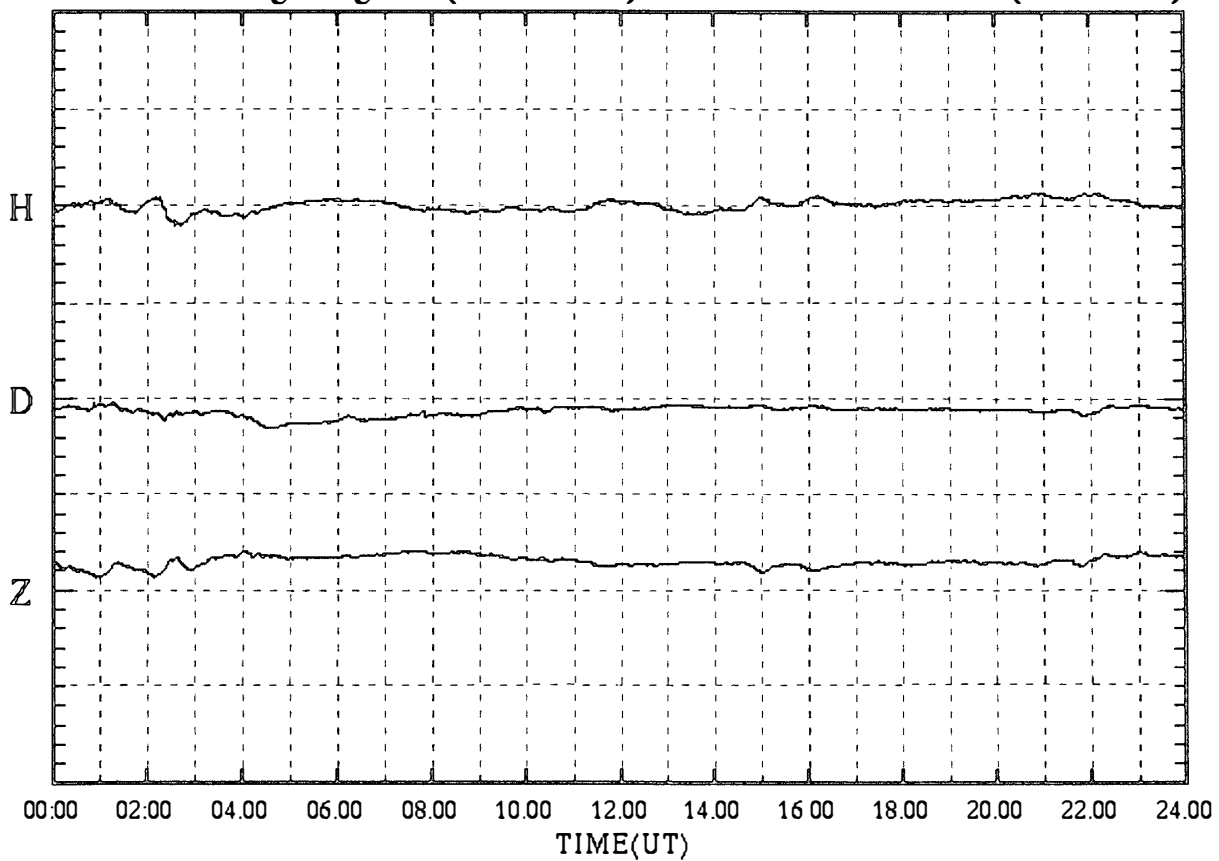

SYOWA magnetogram (100 nT/div)

20 Dec.1999 (DAY:354)

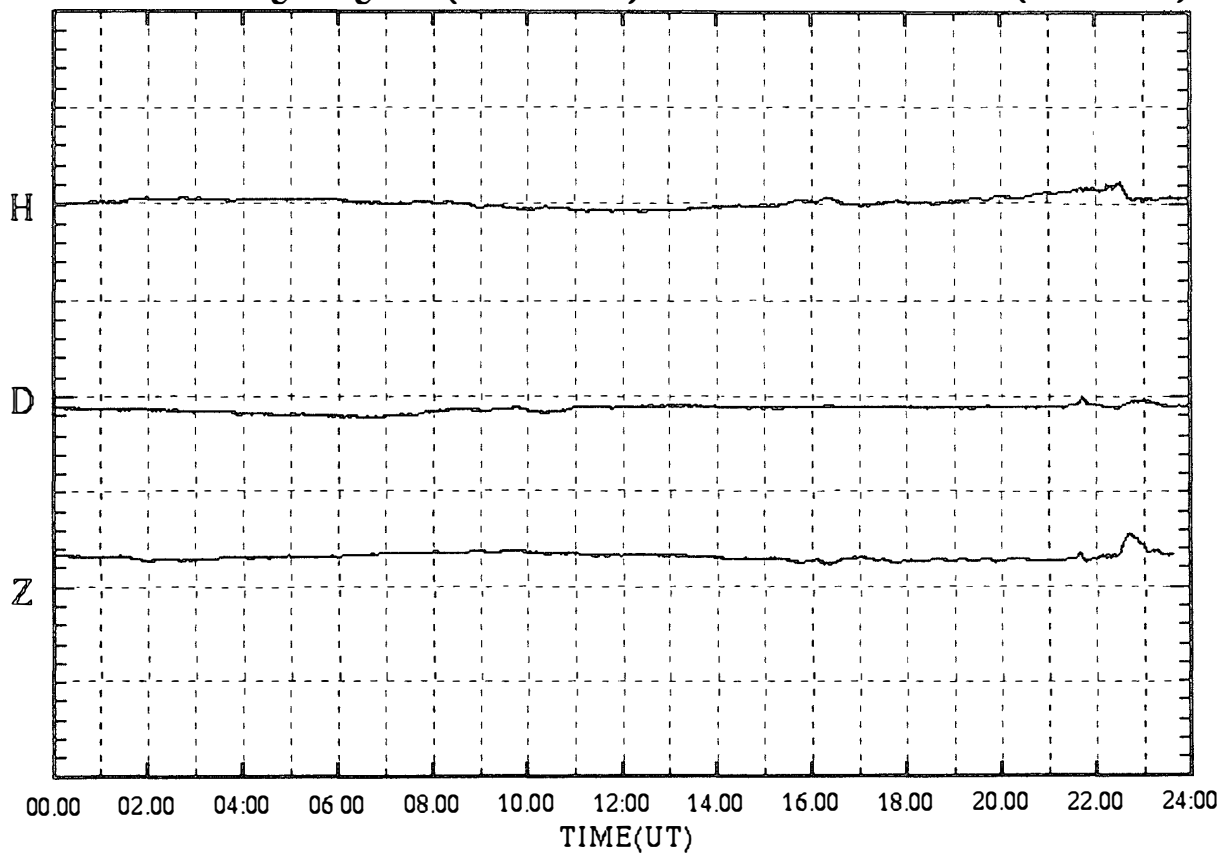

SYOWA magnetogram (100 nT/div)

21 Dec.1999 (DAY:355)

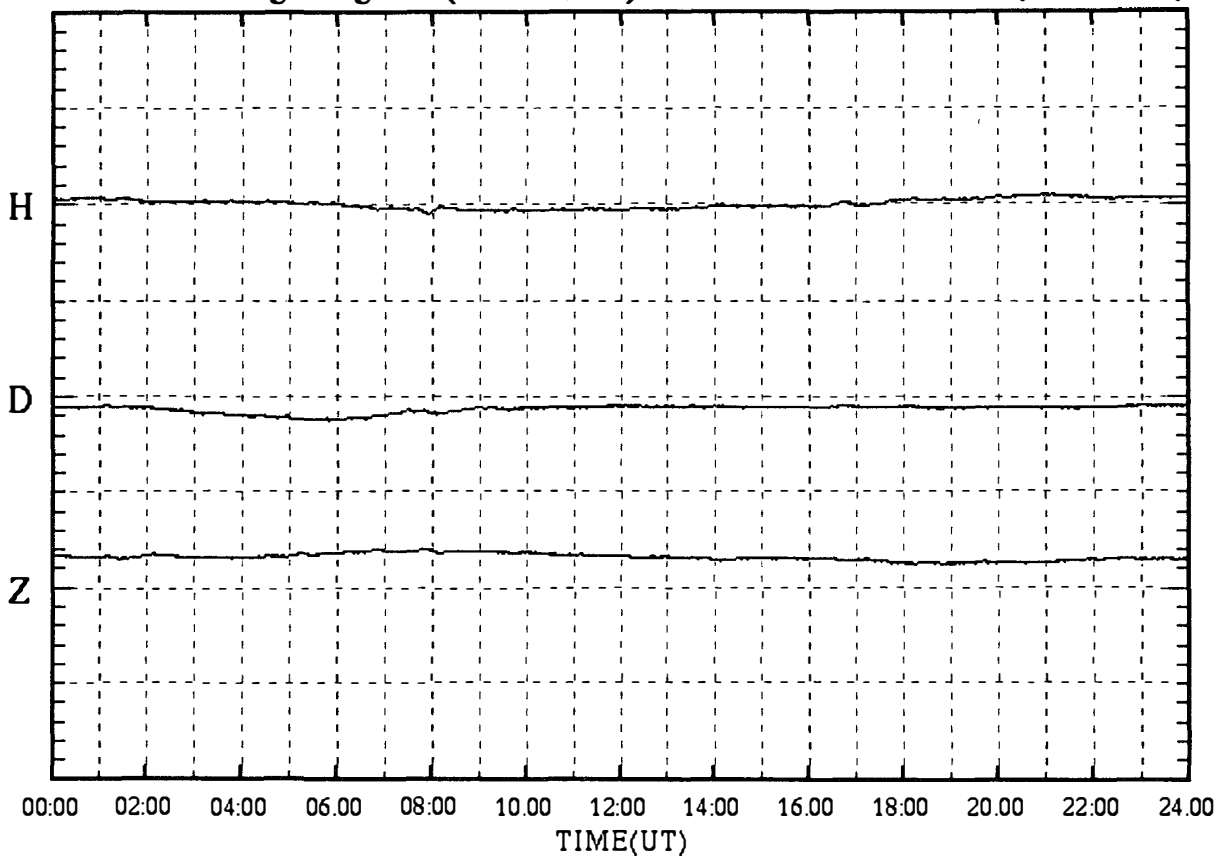

SYOWA magnetogram (100 nT/div)

22 Dec.1999 (DAY:356)

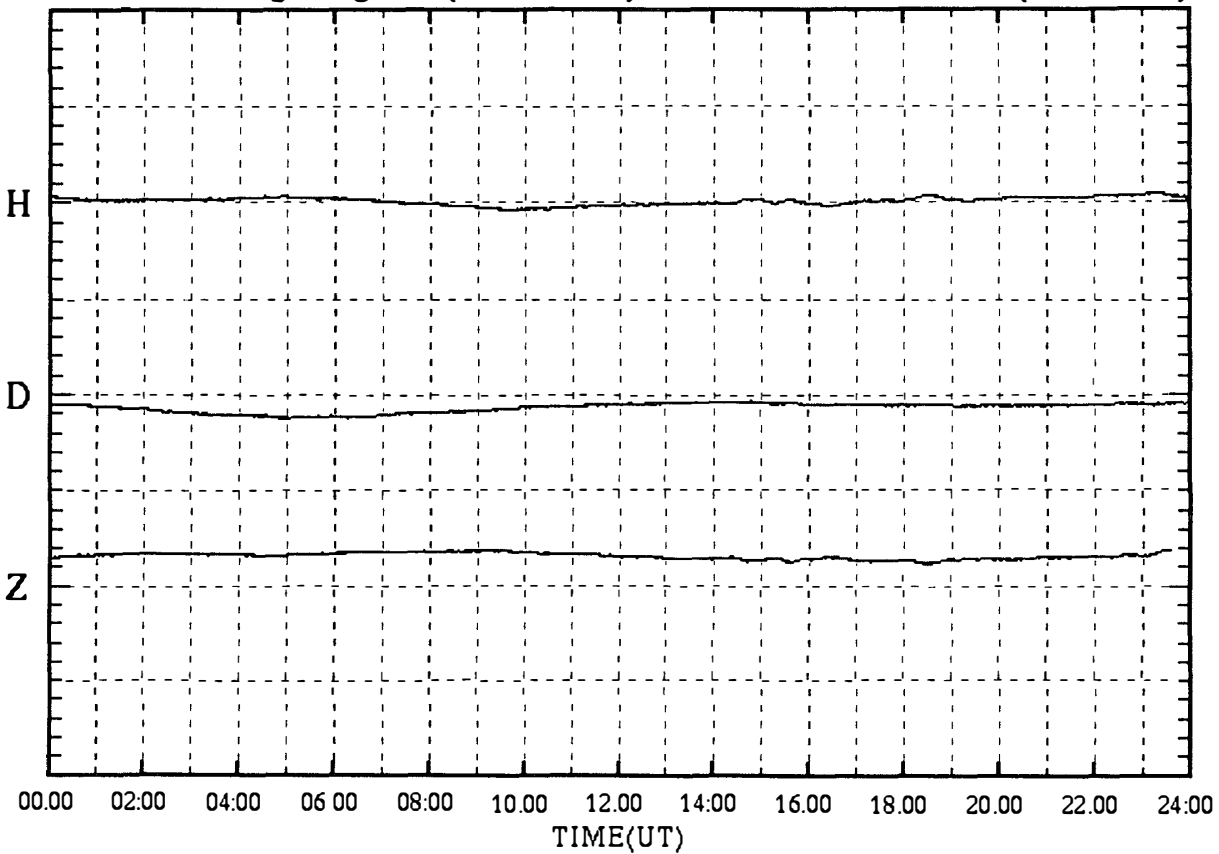

SYOWA magnetogram (100 nT/div)

23 Dec.1999 (DAY:357)

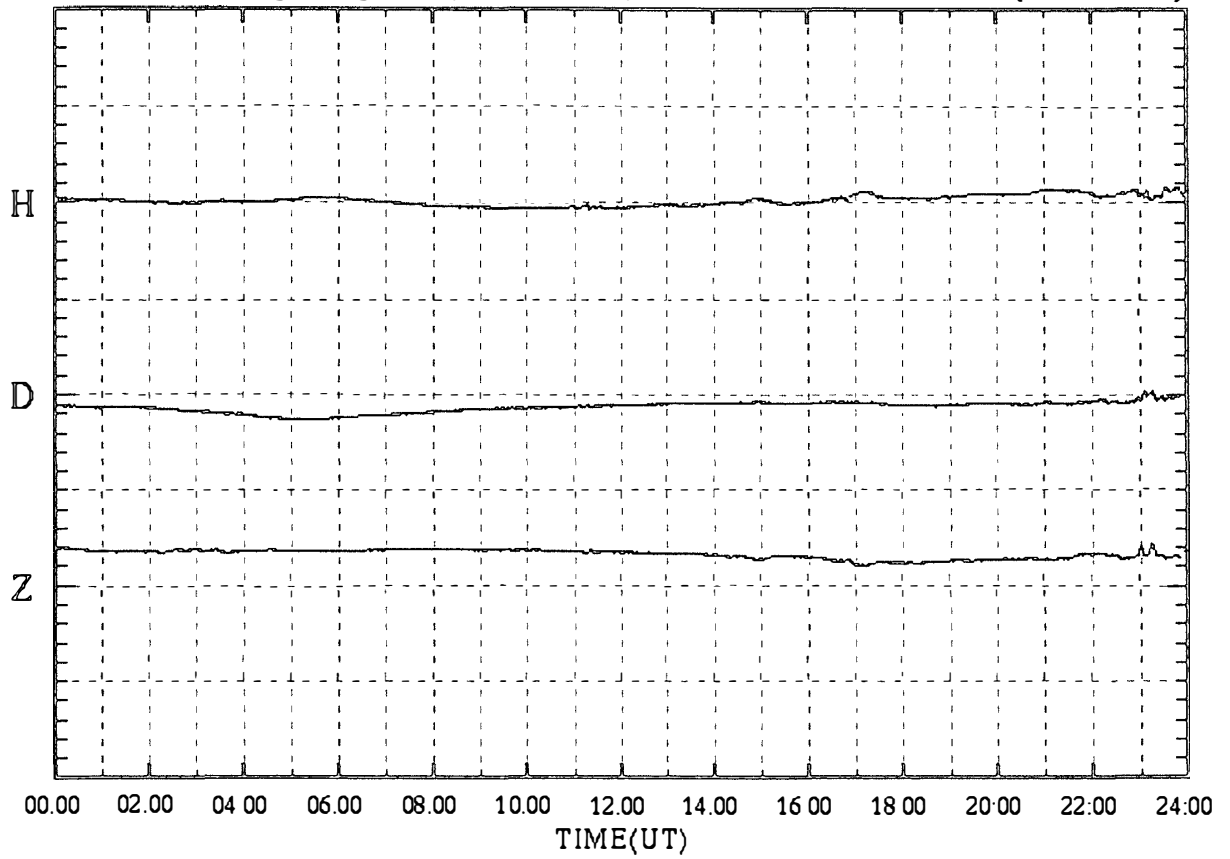

SYOWA magnetogram (100 nT/div)

24 Dec.1999 (DAY:358)

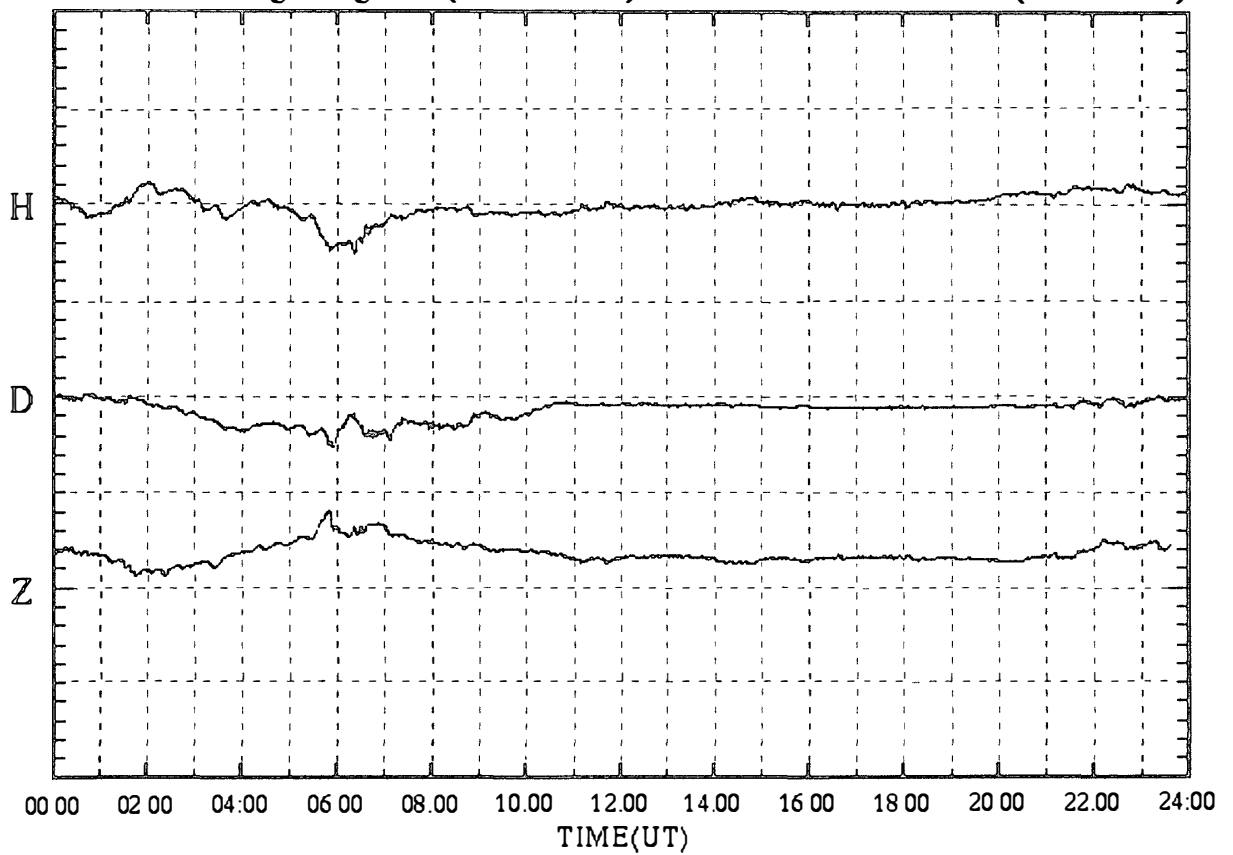

SYOWA magnetogram (100 nT/div)

25 Dec.1999 (DAY:359)

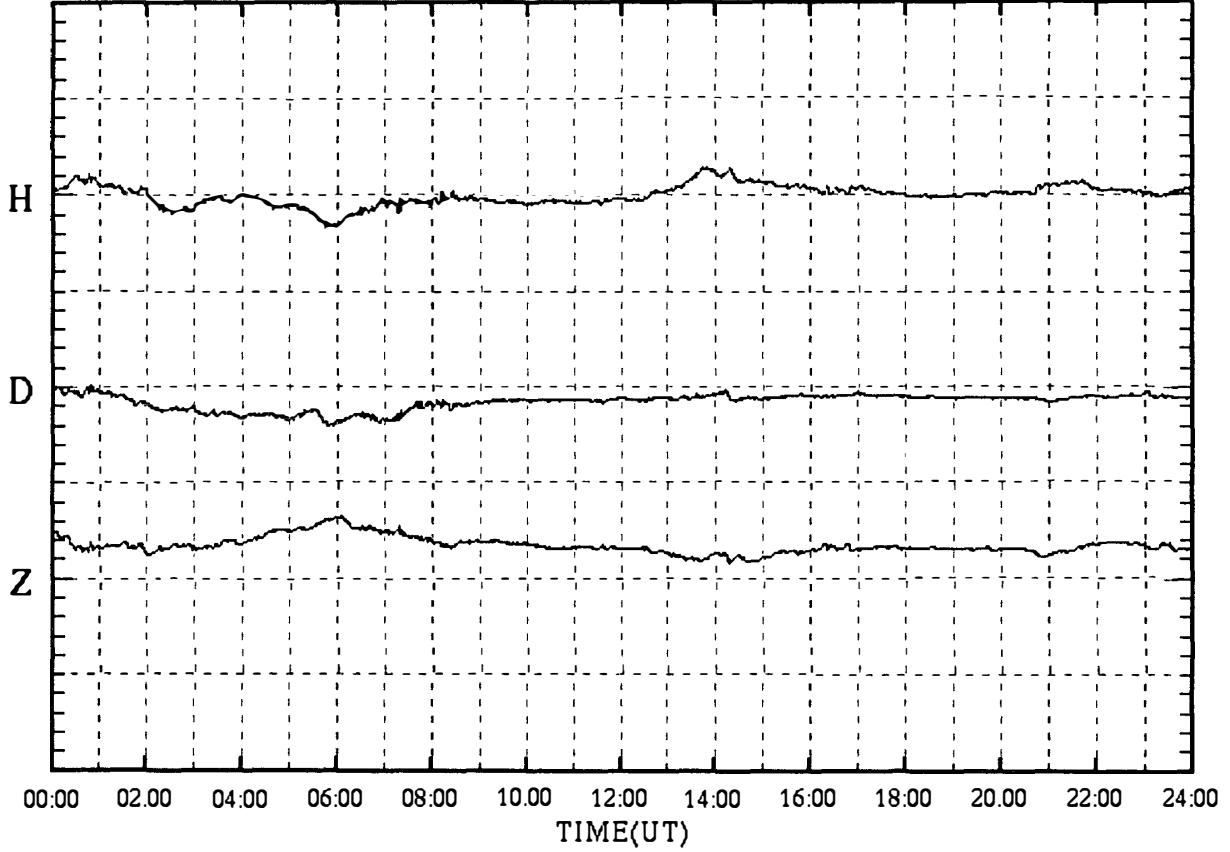

SYOWA magnetogram (100 nT/div)

26 Dec.1999 (DAY:360)

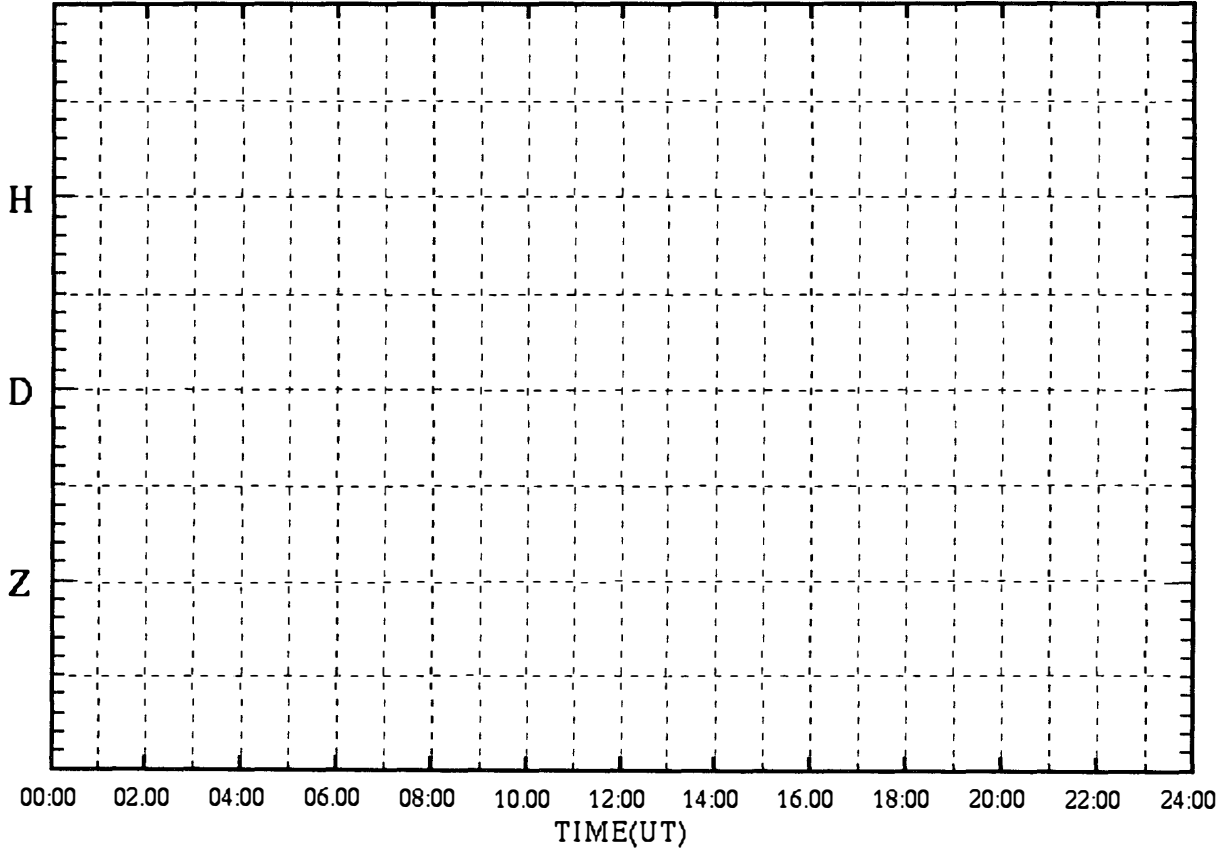

SYOWA magnetogram (100 nT/div)

27 Dec.1999 (DAY:361)

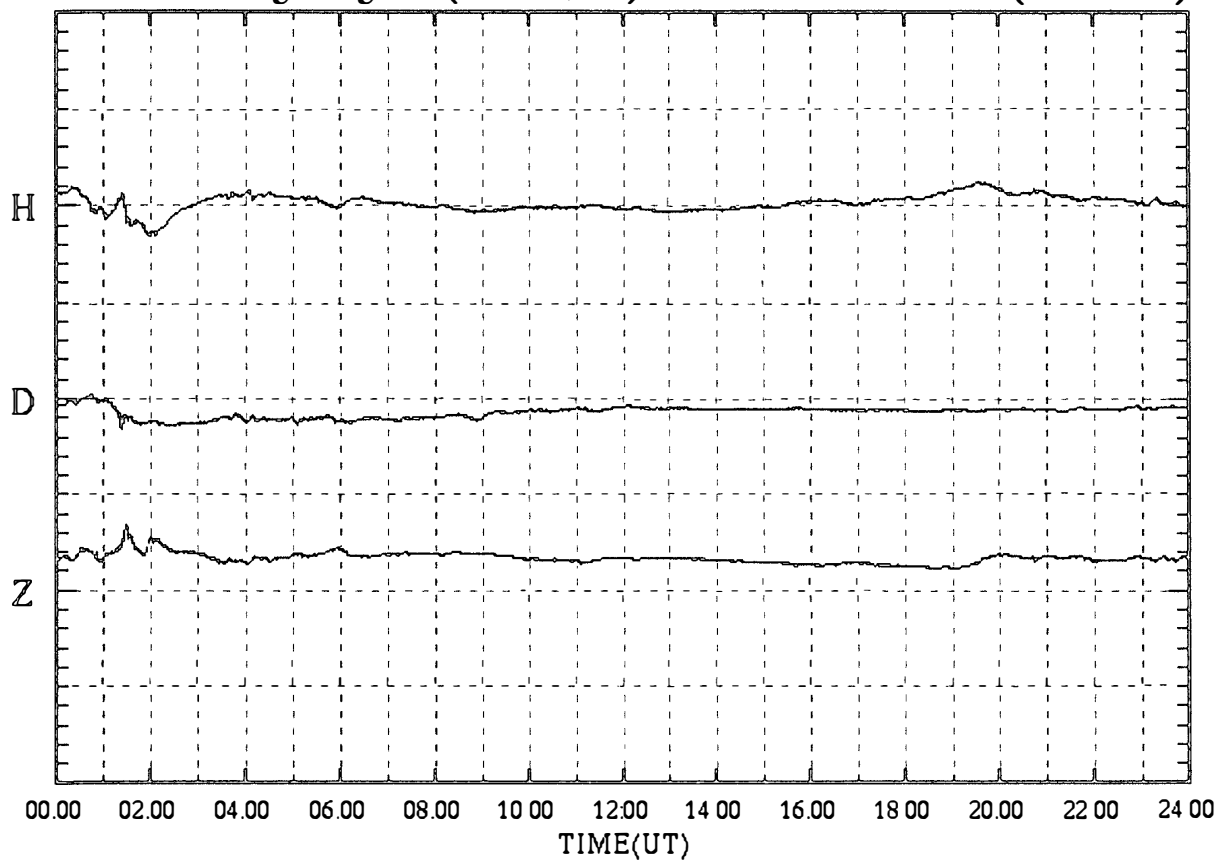

SYOWA magnetogram (100 nT/div)

28 Dec.1999 (DAY:362)

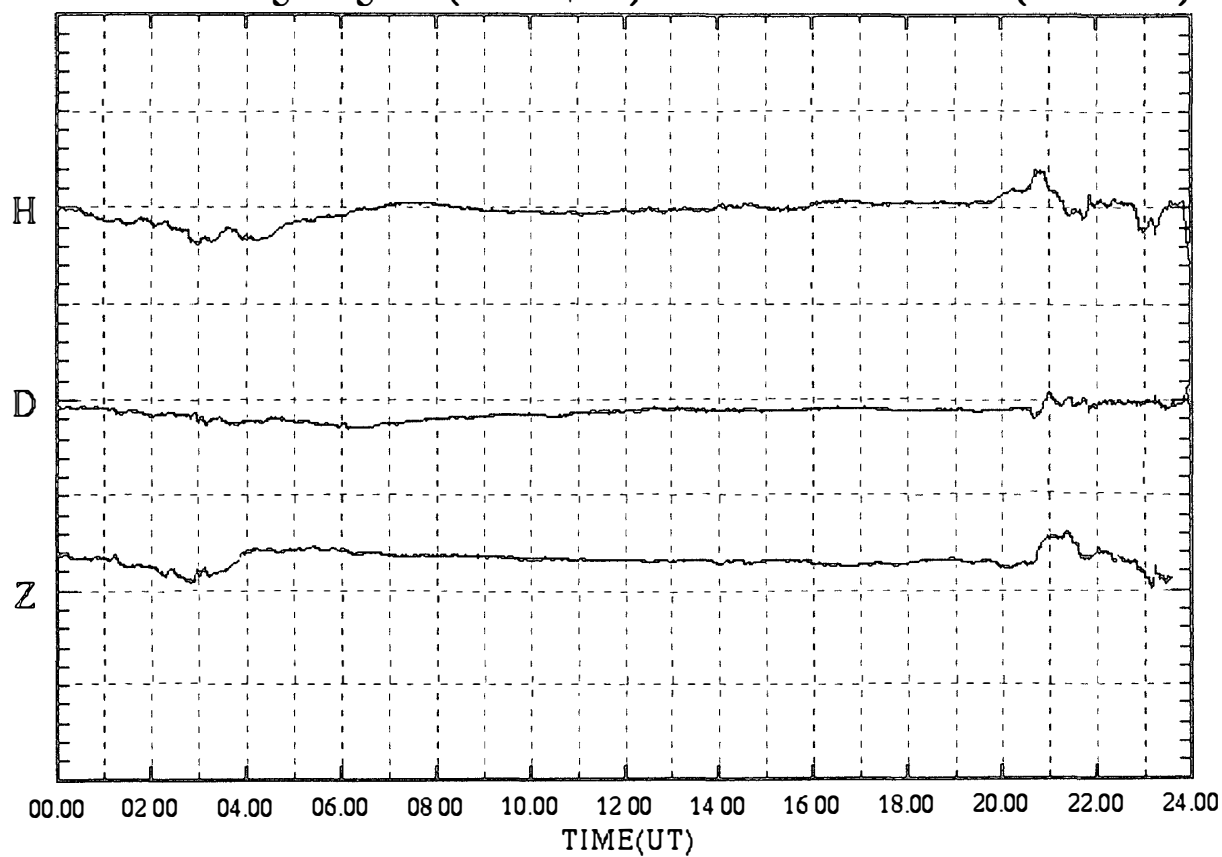

SYOWA magnetogram (100 nT/div)

29 Dec.1999 (DAY:363)

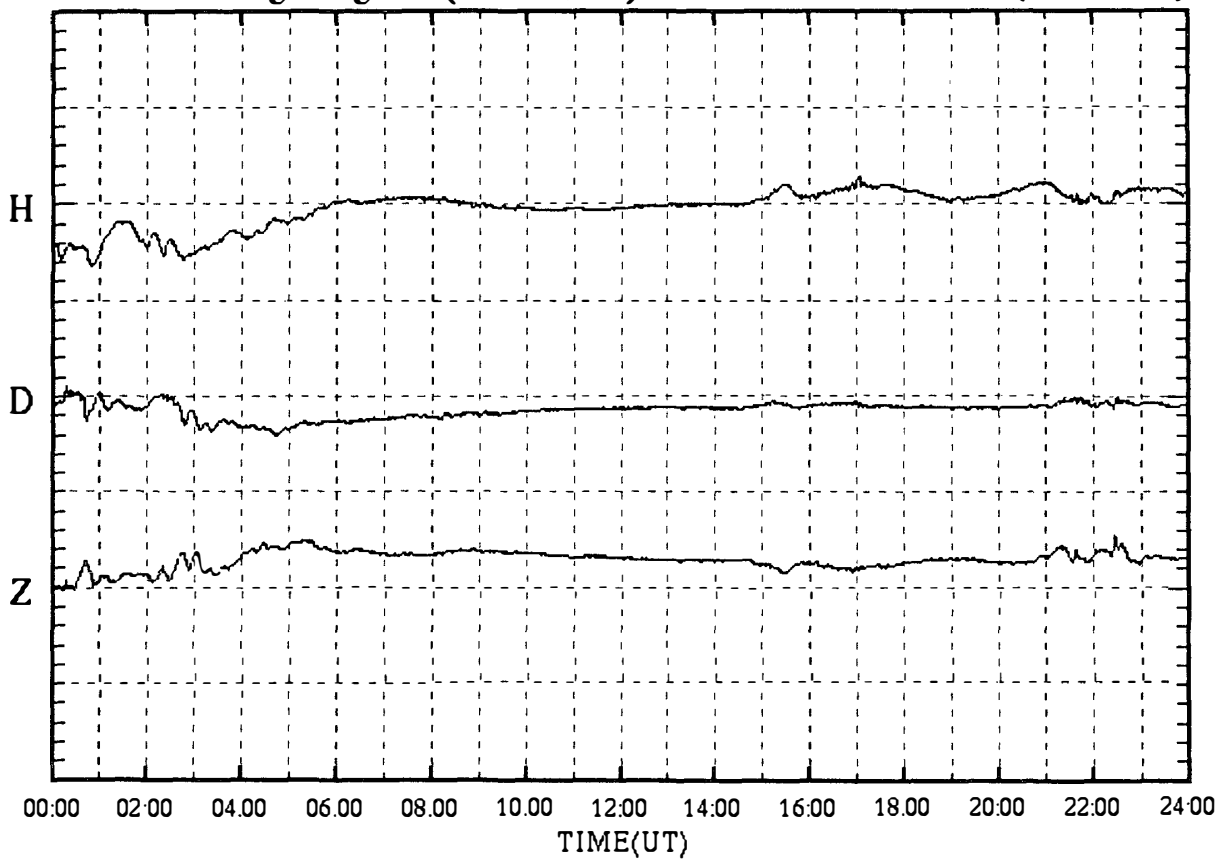

SYOWA magnetogram (100 nT/div)

30 Dec.1999 (DAY:364)

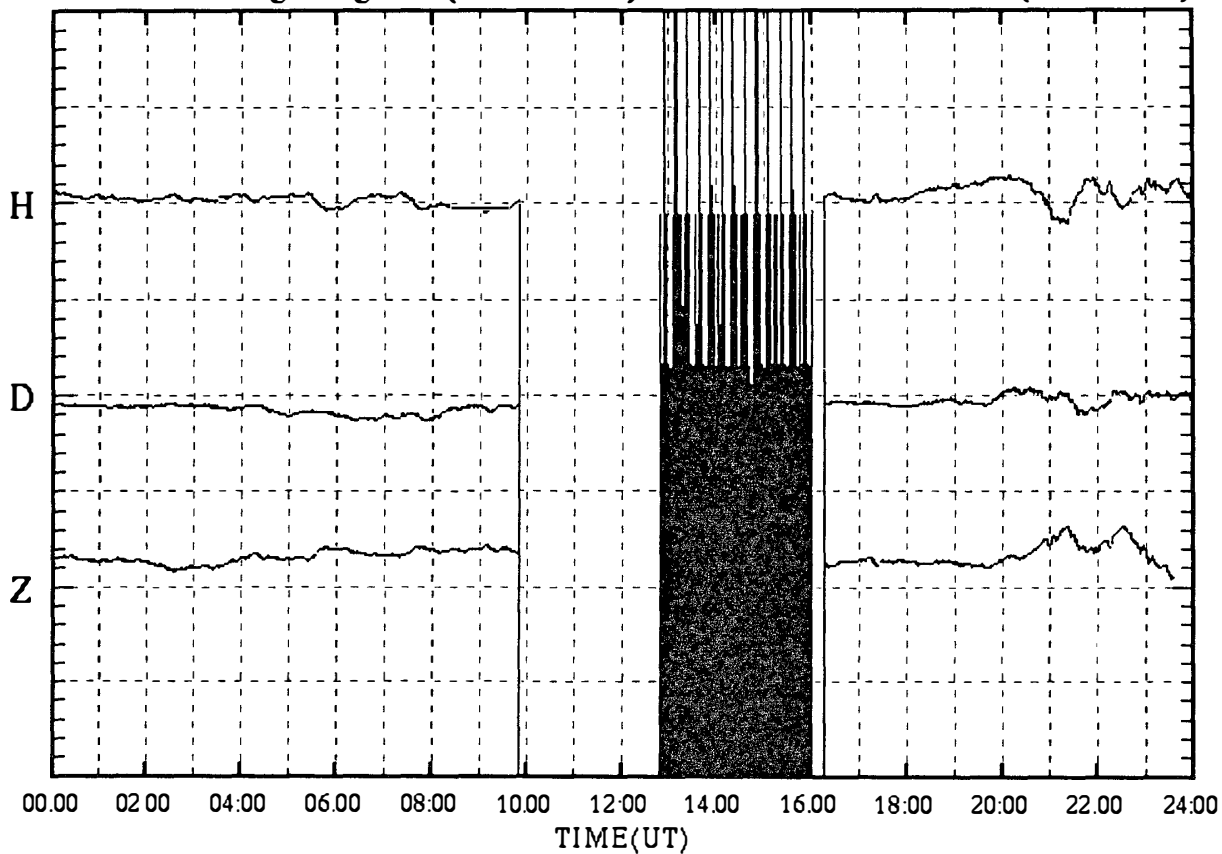

SYOWA magnetogram (100 nT/div)

31 Dec.1999 (DAY:365)

